

User's Manual



L2+ Multi-port Full Gigabit Managed Ethernet Switch

▶ IGS-5225 Series



Trademarks

Copyright © PLANET Technology Corp. 2018.

Contents are subject to revision without prior notice.

PLANET is a registered trademark of PLANET Technology Corp. All other trademarks belong to their respective owners.

Disclaimer

PLANET Technology does not warrant that the hardware will work properly in all environments and applications, and makes no warranty and representation, either implied or expressed, with respect to the quality, performance, merchantability, or fitness for a particular purpose. PLANET has made every effort to ensure that this User's Manual is accurate; PLANET disclaims liability for any inaccuracies or omissions that may have occurred.

Information in this User's Manual is subject to change without notice and does not represent a commitment on the part of PLANET. PLANET assumes no responsibility for any inaccuracies that may be contained in this User's Manual. PLANET makes no commitment to update or keep current the information in this User's Manual, and reserves the right to make improvements to this User's Manual and/or to the products described in this User's Manual, at any time without notice.

If you find information in this manual that is incorrect, misleading, or incomplete, we would appreciate your comments and suggestions.

FCC Warning

This equipment has been tested and found to comply with the limits for a Class A digital device, pursuant to Part 15 of the FCC Rules. These limits are designed to provide reasonable protection against harmful interference when the equipment is operated in a commercial environment. This equipment generates, uses, and can radiate radio frequency energy and, if not installed and used in accordance with the Instruction manual, may cause harmful interference to radio communications. Operation of this equipment in a residential area is likely to cause harmful interference in which case the user will be required to correct the interference at his own expense.

CE Mark Warning

This is a Class A product. In a domestic environment, this product may cause radio interference, in which case the user may be required to take adequate measures.

Energy Saving Note of the Device

This power required device does not support Standby mode operation. For energy saving, please remove the power cable to disconnect the device from the power circuit. In view of saving the energy and reducing the unnecessary power consumption, it is strongly suggested to remove the power connection for the device if this device is not intended to be active.

WEEE Warning

To avoid the potential effects on the environment and human health as a result of the presence of hazardous substances in electrical and electronic equipment, end users of electrical and electronic equipment should understand the meaning of the crossed-out wheeled bin symbol. Do not dispose of WEEE as unsorted municipal waste and have to collect such WEEE separately.



Revision

User's Manual of PLANET Industrial L2+ Multi-port Full Gigabit Industrial Managed Switch

FOR MODEL: IGS-5225-8P2T2S, IGS-5225-4UP1T2Sv3, IGS-5225-4P2S

REVISION: 1.0 (July., 2018)

Part No: EM-IGS-5225 Series_v1.1

TABLE OF CONTENTS

| | |
|--|-----------|
| 1. INTRODUCTION | 10 |
| 1.1 Packet Contents..... | 10 |
| 1.2 Product Description | 11 |
| 1.3 How to Use This Manual | 15 |
| 1.4 Product Features | 16 |
| 1.5 Product Specifications..... | 21 |
| | |
| 2. INSTALLATION | 28 |
| 2.1 Hardware Description..... | 28 |
| 2.1.1 Physical Dimensions | 28 |
| 2.1.2 Front Panel | 32 |
| 2.1.3 LED Indications | 36 |
| 2.1.4 Switch Upper Panel | 41 |
| 2.1.5 Wiring the Fault Alarm Contact..... | 43 |
| 2.1.6 Wiring the Digital Input/Output..... | 43 |
| 2.2 Installing the Industrial Managed Switch | 46 |
| 2.2.1 Installation Steps..... | 46 |
| 2.2.2 DIN-rail Mounting..... | 47 |
| 2.2.3 Wall Mount Plate Mounting..... | 49 |
| 2.3 Cabling..... | 50 |
| 2.3.1 Installing the SFP Transceiver | 51 |
| 2.3.2 Removing the SFP/SFP+ Transceiver..... | 54 |
| | |
| 3. SWITCH MANAGEMENT | 55 |
| 3.1 Requirements | 55 |
| 3.2 Management Access Overview | 56 |
| 3.3 CLI Mode Management..... | 57 |
| 3.4 Web Management | 59 |
| 3.5 SNMP-based Network Management | 60 |
| 3.6 PLANET Smart Discovery Utility..... | 61 |
| | |
| 4. WEB CONFIGURATION | 63 |
| 4.1 Main Web page..... | 66 |
| 4.2 System | 68 |
| 4.2.1 Management..... | 69 |
| 4.2.1.1 System Information..... | 69 |
| 4.2.1.2 IP Configuration..... | 70 |
| 4.2.1.3 IP Status | 73 |

| | | |
|-----------|---|-----|
| 4.2.1.4 | Users Configuration | 74 |
| 4.2.1.5 | Privilege Levels | 77 |
| 4.2.1.6 | NTP Configuration | 78 |
| 4.2.1.6.1 | System Time Correction Manually | 80 |
| 4.2.1.7 | Time Configuration | 81 |
| 4.2.1.8 | UPnP | 82 |
| 4.2.1.9 | DHCP Relay | 83 |
| 4.2.1.10 | DHCP Relay Statistics | 85 |
| 4.2.1.11 | CPU Load | 87 |
| 4.2.1.12 | System Log | 88 |
| 4.2.1.13 | Detailed Log | 89 |
| 4.2.1.14 | Remote Syslog | 90 |
| 4.2.1.15 | SMTP Configuration | 91 |
| 4.2.1.16 | Fault Alarm | 92 |
| 4.2.1.17 | Digital Input/Output..... | 93 |
| 4.2.2 | Simple Network Management Protocol | 95 |
| 4.2.2.1 | SNMP Overview | 95 |
| 4.2.2.2 | SNMP System Configuration..... | 96 |
| 4.2.2.3 | SNMP Trap Configuration..... | 98 |
| 4.2.2.4 | SNMP System Information | 100 |
| 4.2.2.5 | SNMPv3 Communities | 100 |
| 4.2.2.6 | SNMPv3 Users..... | 102 |
| 4.2.2.7 | SNMPv3 Groups..... | 103 |
| 4.2.2.8 | SNMPv3 Views..... | 104 |
| 4.2.2.9 | SNMPv3 Access..... | 105 |
| 4.2.3 | RMON..... | 107 |
| 4.2.3.1 | RMON Alarm Configuration | 107 |
| 4.2.3.2 | RMON Alarm Status | 109 |
| 4.2.3.3 | RMON Event Configuration | 110 |
| 4.2.3.4 | RMON Event Status | 111 |
| 4.2.3.5 | RMON History Configuration | 112 |
| 4.2.3.6 | RMON History Status | 113 |
| 4.2.3.7 | RMON Statistics Configuration | 114 |
| 4.2.3.8 | RMON Statistics Status | 115 |
| 4.2.4 | DHCP server | 117 |
| 4.2.4.1 | DHCP Server Mode Configuration..... | 117 |
| 4.2.4.2 | DHCP Server excluded IP Configuration | 118 |
| 4.2.4.3 | DHCP Server pool Configuration..... | 119 |
| 4.2.4.4 | DHCP Server pool Configuration..... | 120 |
| 4.2.4.5 | DHCP Server Binding IP Configuration | 121 |
| 4.2.4.6 | DHCP Server Declined IP | 122 |

| | |
|---|------------|
| 4.2.4.7 DHCP Detail Statistics | 123 |
| 4.2.5 Industrial Protocol..... | 125 |
| 4.2.5.1 Protocol Configuration..... | 125 |
| 4.3 Switching..... | 126 |
| 4.3.1 Port Management..... | 126 |
| 4.3.1.1 Port Configuration..... | 126 |
| 4.3.1.2 Port Statistics Overview..... | 128 |
| 4.3.1.3 Port Statistics Details..... | 128 |
| 4.3.1.4 SFP Module Information..... | 130 |
| 4.3.1.5 Port Mirror | 132 |
| 4.3.2 Link Aggregation..... | 136 |
| 4.3.2.1 Static Aggregation..... | 138 |
| 4.3.2.2 Static Aggregation Status..... | 139 |
| 4.3.2.3 LACP Configuration..... | 140 |
| 4.3.2.4 LACP System Status | 142 |
| 4.3.2.5 LACP Port Status..... | 143 |
| 4.3.2.6 LACP Port Statistics | 144 |
| 4.3.3 VLAN | 145 |
| 4.3.3.1 VLAN Overview | 145 |
| 4.3.3.2 IEEE 802.1Q VLAN..... | 146 |
| 4.3.3.3 VLAN Port Configuration | 149 |
| 4.3.3.4 VLAN Membership Status | 155 |
| 4.3.3.5 VLAN Port Status..... | 156 |
| 4.3.3.6 Private VLAN..... | 157 |
| 4.3.3.7 Port Isolation | 159 |
| 4.3.3.8 VLAN setting example:..... | 161 |
| 4.3.3.8.1 Two Separate 802.1Q VLANs..... | 161 |
| 4.3.3.8.2 VLAN Trunking between two 802.1Q aware switches | 163 |
| 4.3.3.8.3 Port Isolate | 166 |
| 4.3.3.9 MAC-based VLAN..... | 167 |
| 4.3.3.10 IP Subnet-based VLAN Membership Configuration..... | 168 |
| 4.3.3.11 Protocol-based VLAN | 169 |
| 4.3.3.12 Protocol-based VLAN Membership | 171 |
| 4.3.4 Spanning Tree Protocol | 173 |
| 4.3.4.1 Theory | 173 |
| 4.3.4.2 STP System Configuration | 179 |
| 4.3.4.3 Bridge Status | 181 |
| 4.3.4.4 CIST Port Configuration | 182 |
| 4.3.4.5 MSTI Priorities..... | 185 |
| 4.3.4.6 MSTI Configuration..... | 186 |
| 4.3.4.7 MSTI Ports Configuration | 187 |

- 4.3.4.8 Port Status 189
- 4.3.4.9 Port Statistics 190
- 4.3.5 Multicast 191
 - 4.3.5.1 IGMP Snooping 191
 - 4.3.5.2 Profile Table 194
 - 4.3.5.3 Address Entry 196
 - 4.3.5.4 IGMP Snooping Configuration 197
 - 4.3.5.5 IGMP Snooping VLAN Configuration 198
 - 4.3.5.6 IGMP Snooping Port Group Filtering 200
 - 4.3.5.7 IGMP Snooping Status 201
 - 4.3.5.8 IGMP Group Information 203
- 4.3.6 MLD Snooping 204
 - 4.3.6.1 MLD Snooping Configuration 204
 - 4.3.6.2 MLD Snooping VLAN Configuration 205
 - 4.3.6.3 MLD Snooping Port Group Filtering 207
 - 4.3.6.4 MLD Snooping Status 208
 - 4.3.6.5 MLD Group Information 209
 - 4.3.6.6 MLDv2 Information 210
- 4.3.7 MVR (Multicast VLAN Registration) 212
 - 4.3.7.1 MVR Configuration 212
 - 4.3.7.2 MVR Status 215
 - 4.3.7.3 MVR Groups Information 216
 - 4.3.7.4 MVR SFM Information 216
- 4.3.8 LLDP 218
 - 4.3.8.1 Link Layer Discovery Protocol 218
 - 4.3.8.2 LLDP Configuration 218
 - 4.3.8.3 LLDP Neighbor 221
 - 4.3.8.4 LLDP MED Configuration 222
 - 4.3.8.5 LLDP-MED Neighbor 229
 - 4.3.8.6 Port Statistics 233
- 4.3.9 MAC Address Table 236
 - 4.3.9.1 MAC Table Configuration 236
 - 4.3.9.2 MAC Address Table Status 238
- 4.3.10 Loop Protection 240
 - 4.3.10.1 Configuration 240
 - 4.3.10.2 Loop Protection Status 241
- 4.3.11 UDLD 243
 - 4.3.11.1 UDLD Port Configuration 243
 - 4.3.11.2 UDLD Status 244
- 4.3.12 GVRP 246
 - 4.3.12.1 GVRP Configuration 246

| | |
|---|------------|
| 4.3.12.2 GVRP Port Configuration | 247 |
| 4.3.13 PTP..... | 249 |
| 4.3.13.1 PTP Configuration | 249 |
| 4.4 Quality of Service | 254 |
| 4.4.1 General..... | 254 |
| 4.4.1.1 QoS Port Classification..... | 255 |
| 4.4.1.2 Queue Policing | 257 |
| 4.4.1.3 Port Tag Remarking..... | 258 |
| 4.4.1.4 WERD | 258 |
| 4.4.1.5 Statistics | 260 |
| 4.4.2 Bandwidth Control | 261 |
| 4.4.2.1 Port Policing | 261 |
| 4.4.2.2 Port Schedule..... | 262 |
| 4.4.2.3 Port Shaping..... | 263 |
| 4.4.3 Storm Control..... | 266 |
| 4.4.3.1 Storm Policing Configuration | 266 |
| 4.4.4 Differentiated Service | 267 |
| 4.4.4.1 Port DSCP..... | 267 |
| 4.4.4.2 DSCP-based QoS | 268 |
| 4.4.4.3 DSCP Translation | 269 |
| 4.4.4.4 DSCP Classification | 270 |
| 4.4.5 QCL | 272 |
| 4.4.5.1 QoS Control List..... | 272 |
| 4.4.5.2 QoS Control Entry Configuration | 273 |
| 4.4.5.3 QCL Status | 276 |
| 4.4.5.4 Voice VLAN Configuration | 277 |
| 4.4.5.5 Voice VLAN OUI Table | 280 |
| 4.5 Security..... | 281 |
| 4.5.1 Access Security | 281 |
| 4.5.1.1 Access Management | 281 |
| 4.5.1.2 Access Management Statistics | 282 |
| 4.5.1.3 SSH..... | 283 |
| 4.5.1.4 HTTPs | 284 |
| 4.5.2 AAA | 286 |
| 4.5.2.1 Authentication Configuration..... | 291 |
| 4.5.2.2 RADIUS..... | 293 |
| 4.5.2.3 TACACS+ | 295 |
| 4.5.2.4 RADIUS Overview | 297 |
| 4.5.2.5 RADIUS Details..... | 298 |
| 4.5.3 Port Authentication | 306 |
| 4.5.3.1 Network Access Server Configuration | 306 |

| | |
|--|------------|
| 4.5.3.2 Network Access Overview | 309 |
| 4.5.3.3 Network Access Statistics | 311 |
| 4.5.4 Port Security | 316 |
| 4.5.4.1 Port Limit Control..... | 316 |
| 4.5.4.2 Port Security Status | 319 |
| 4.5.4.3 Port Security Detail..... | 321 |
| 4.5.5 Access Control Lists | 323 |
| 4.5.5.1 Access Control List Status | 323 |
| 4.5.5.2 Access Control List Configuration..... | 324 |
| 4.5.5.3 ACE Configuration | 326 |
| 4.5.5.4 ACL Ports Configuration | 336 |
| 4.5.5.5 ACL Rate Limiters..... | 338 |
| 4.5.6 DHCP Snooping | 340 |
| 4.5.6.1 DHCP Snooping Configuration | 340 |
| 4.5.6.2 Snooping Table..... | 342 |
| 4.5.7 IP Source Guard..... | 343 |
| 4.5.7.1 IP Source Guard Configuration..... | 343 |
| 4.5.7.2 Static IP Source Guard Table..... | 344 |
| 4.5.7.3 Dynamic IP Source Guard Table | 345 |
| 4.5.8 ARP Inspection | 346 |
| 4.5.8.1 ARP Inspection..... | 346 |
| 4.5.8.2 ARP Inspection Static Table..... | 347 |
| 4.5.8.3 Dynamic ARP Inspection Table..... | 348 |
| 4.6 Power over Ethernet..... | 350 |
| 4.6.1 PoE..... | 350 |
| 4.6.1.1 Power over Ethernet Powered Device..... | 351 |
| 4.6.1.2 System Configuration | 351 |
| 4.6.1.3 Power over Ethernet Configuration..... | 352 |
| 4.6.1.4 Port Configuration..... | 354 |
| 4.6.1.5 PoE Status..... | 356 |
| 4.6.1.6 Port Sequential..... | 357 |
| 4.6.1.7 PoE Schedule..... | 358 |
| 4.6.1.8 PoE Alive Check Configuration..... | 361 |
| 4.6.1.9 LLDP PoE Neighbors | 362 |
| 4.7 Ring..... | 364 |
| 4.7.1 Ring..... | 364 |
| 4.7.1.1 MEP Configuration | 365 |
| 4.7.1.2 Detailed MEP Configuration | 366 |
| 4.7.1.3 Ethernet Ring Protocol Switch..... | 370 |
| 4.7.1.4 Ethernet Ring Protocol Switch Configuration..... | 371 |
| 4.7.1.5 Ethernet Ring Protocol Switch..... | 374 |

| | |
|---|------------|
| 4.7.1.6 Ring Wizard Example | 376 |
| 4.8 ONVIF | 379 |
| 4.8.1 ONVIF..... | 379 |
| 4.8.1.1 ONVIF Device Search | 379 |
| 4.8.1.2 ONVIF Device List..... | 380 |
| 4.8.1.3 MAP Upload / Edit | 381 |
| 4.8.1.4 Floor Map | 382 |
| 4.9 Maintenance | 384 |
| 4.9.1 Switch Maintenance | 384 |
| 4.9.1.1 Web Firmware Upgrade | 384 |
| 4.9.1.2 Save Startup Config..... | 385 |
| 4.9.1.3 Configuration Download | 385 |
| 4.9.1.4 Configuration Upload..... | 386 |
| 4.9.1.5 Configuration Activate..... | 386 |
| 4.9.1.6 Configuration Delete..... | 387 |
| 4.9.1.7 Image Select | 387 |
| 4.9.1.8 Factory Default | 388 |
| 4.9.1.9 Configuration Download | 389 |
| 4.9.2 Diagnostics | 390 |
| 4.9.2.1 Ping | 390 |
| 4.9.2.2 IPv6 Ping | 391 |
| 4.9.2.3 Remote IP Ping Test..... | 392 |
| 4.9.2.4 Cable Diagnostics..... | 393 |
| | |
| 5. SWITCH OPERATION | 396 |
| 5.1 Address Table..... | 396 |
| 5.2 Learning..... | 396 |
| 5.3 Forwarding & Filtering | 396 |
| 5.4 Store-and-Forward..... | 396 |
| 5.5 Auto-Negotiation..... | 397 |
| | |
| 6. TROUBLESHOOTING..... | 398 |
| | |
| APPENDIX A: Networking Connection | 399 |
| A.1 Switch's Data RJ45 Pin Assignments - 1000Mbps, 1000BASE-T | 399 |
| A.2 10/100Mbps, 10/100BASE-TX | 399 |
| | |
| APPENDIX B : GLOSSARY | 401 |

1. INTRODUCTION

The descriptions of PLANET L2+ Industrial Managed Switch series, such as IGS-5225-4UP1T2S and IGS-5225-8P2T2S are as follows:

| | |
|-------------------------|--|
| IGS-5225-4UP1T2S | Industrial L2+ 4-Port 10/100/1000T Ultra PoE + 1-Port 10/100/1000T Managed Switch with 2-Port 100/1000X SFP |
| IGS-5225-8P2T2S | Industrial L2+ 8-Port 10/100/1000T 802.3at PoE Managed Ethernet Switch with 2-Port 10/100/1000T + 2-Port 100/1000X SFP |
| IGS-5225-4P2S | Industrial L2+ 4-Port 10/100/1000T 802.3at PoE Managed Ethernet Switch with 2-Port 100/1000X SFP |

“Industrial Managed Switch” is used as an alternative name for the above models in this user’s manual.

1.1 Packet Contents

Open the box of the Industrial Managed Switch and carefully unpack it. The box should contain the following items:

| Model Name / Item | IGS-5225-4UP1T2S | IGS-5225-8P2T2S | IGS-5225-4P2S |
|-------------------------------|------------------|-----------------|---------------|
| The Industrial Managed Switch | ■ | ■ | ■ |
| Quick Installation Guide | ■ | ■ | ■ |
| RS232 to RJ45 Console Cable | ■ | ■ | ■ |
| DIN-rail Kit | ■ | ■ | ■ |
| Wall Mounting Kit | ■ | ■ | ■ |
| SFP Dust Caps | 2 | 2 | 2 |
| RJ45 Dust Caps | 6 | 11 | 5 |

If any of these are missing or damaged, please contact your dealer immediately; if possible, retain the carton including the original packing material, and use them again to repack the product in case there is a need to return it to us for repair.

1.2 Product Description

PLANET Industrial Managed Switch is specially designed to build a full Gigabit backbone to transmit reliable and high-speed data in heavy industrial demanding environments and forward data to remote network through fiber optic cabling. It comes with an IP30 rugged case and redundant power system. Besides support for 60Gbps switch fabric to handle extremely large amounts of video, voice and important data in a secure topology, the Industrial Managed Switch provides user-friendly but advanced **IPv6/ IPv4 management** interfaces and abundant L2/L4 switching functions. It is the best investment for expanding industrial business or upgrading its network infrastructure.

Redundant Ring, Fast Recovery for Critical Network Applications

The Industrial Managed Switch supports redundant ring technology and features strong, rapid self-recovery capability to prevent interruptions and external intrusions. It incorporates advanced **ITU-T G.8032 ERPS (Ethernet Ring Protection Switching)** technology, Spanning Tree Protocol (802.1s MSTP), and **redundant power** input system into customer's industrial automation network to enhance system reliability and uptime in harsh factory environments. In a certain simple Ring network, the recovery time of data link can be as fast as 10ms.

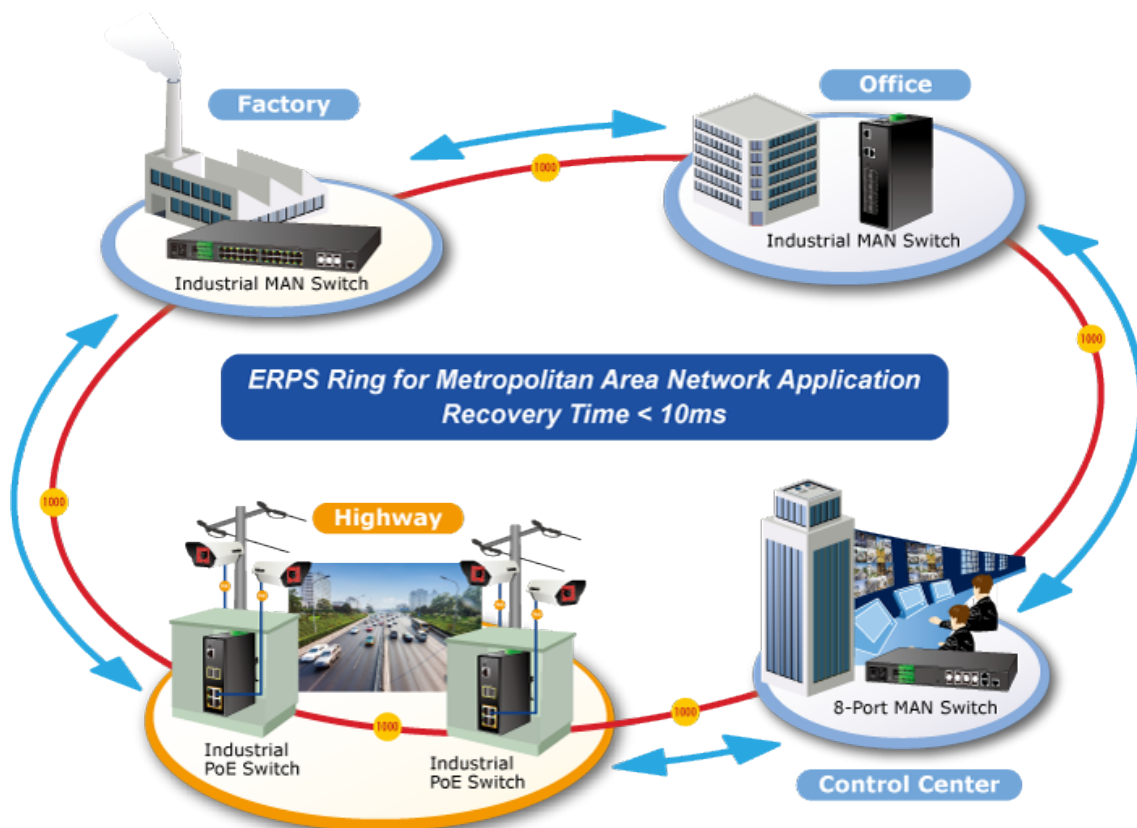

Environmentally Hardened Design

With IP30 aluminum case, the Industrial Managed Switch provides a high level of immunity against electromagnetic interference and heavy electrical surges which are usually found on plant floors or in curb-side traffic control cabinets. It also possesses an integrated power supply source with a wide range of voltages for worldwide high availability applications requiring dual or backup power inputs. Being able to operate under the temperature range from **-40 to 75 degrees C**, the Industrial Managed Switch can be placed in almost any difficult environment.

Digital Input and Digital Output for External Alarm

The Industrial Managed Switch supports Digital Input and Digital Output on its upper panel. The external alarm enables users to use Digital Input to detect external device's status (such as door intrusion detector), and send event alarm to the administrators. The Digital Output could be used to alarm the administrators if the Industrial Managed Switch port is link-down, link-up or power-dead.

Digital Input

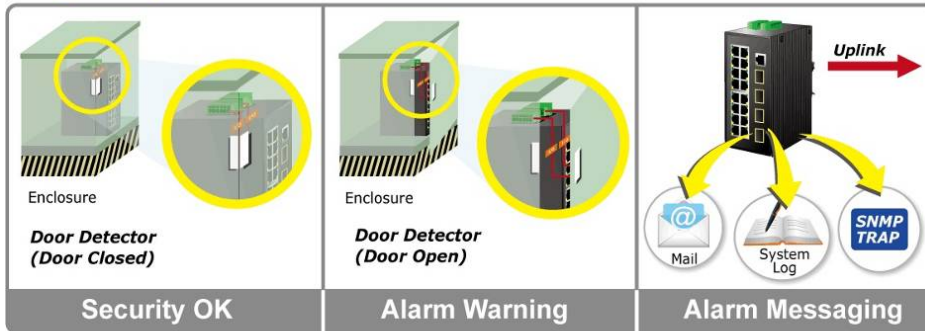

Digital Output

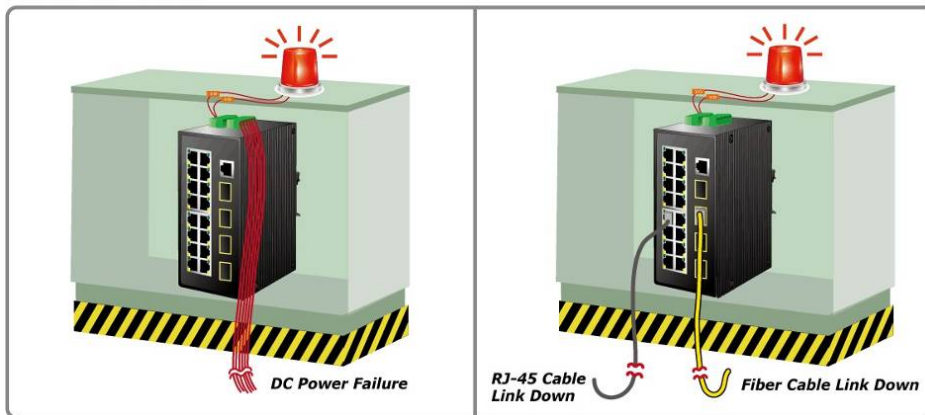

Intelligent Powered Device Alive Check

The Industrial Managed PoE Switch can be configured to monitor connected PD (powered device) status in real-time via ping action. Once the PD stops working and responding, the Industrial Managed PoE Switch will recycle the PoE port power and bring the PD back to work. It will greatly enhance the network reliability through the PoE port resetting the PD's power source and reduce administrator management burden.

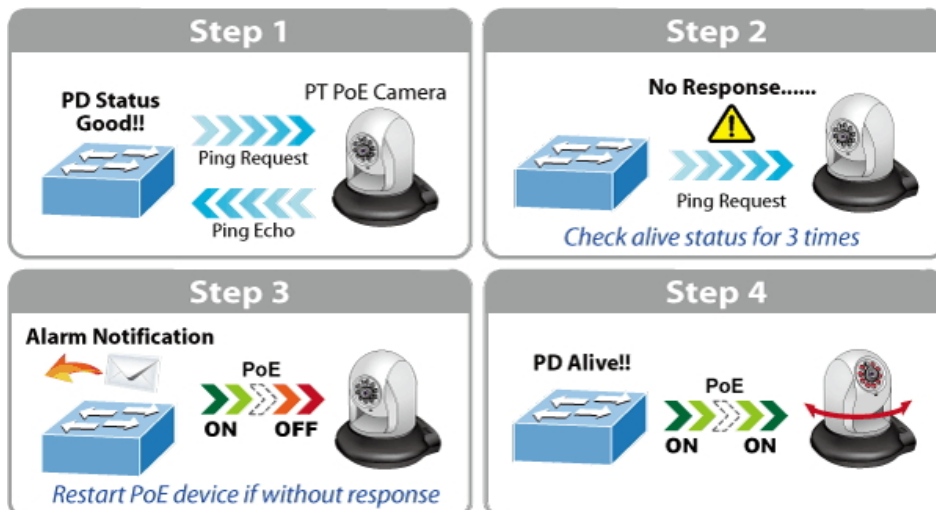

PoE Schedule for Energy Saving

Under the trend of energy saving worldwide and contributing to environment protection on the Earth, the Industrial Managed PoE Switch can effectively control the power supply along with its capability of giving high watts power over Ethernet. The "PoE schedule" function enables you to activate or inactivate PoE power feeding for each PoE port during specified time intervals, which is a powerful function to help SMBs or enterprises save power and money.

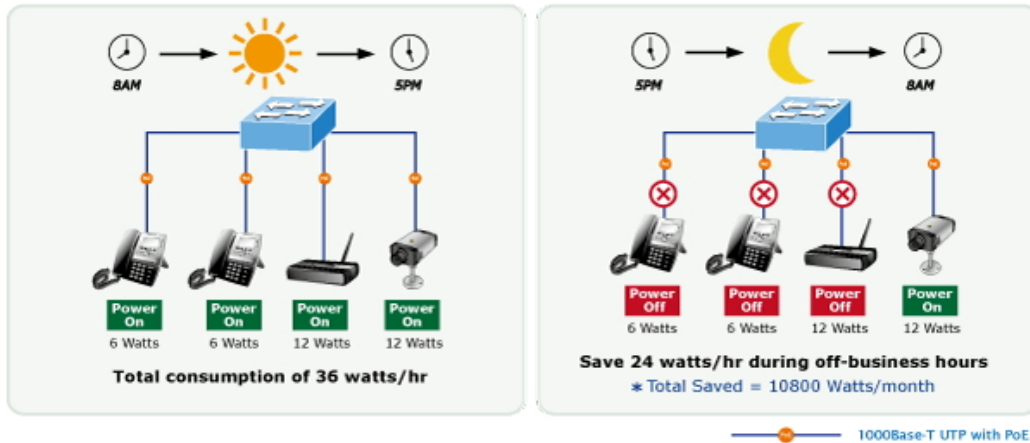

Robust Layer 2 Features

The Industrial Managed Switch can be programmed for advanced switch management function, such as dynamic port link aggregation, **Q-in-Q VLAN**, **Multiple Spanning Tree Protocol (MSTP)**, Layer 2/4 QoS, bandwidth control and **IGMP/MLD snooping**. The Industrial Managed Switch allows the operation of a high-speed trunk combining multiple ports.

IPv6/IPv4 Full-function Secure Switch for Building Automation Networking

The Industrial Managed Switch is the ideal solution to fulfilling the demand of IPv6 management Gigabit Ethernet Switch, especially in the Industrial hardened environment. It supports both IPv4 and IPv6 protocols, advanced Layer 2 to Layer 4 data switching and redundancy, QoS traffic control, network access control and authentication, and Secure Management features to protect customer's industrial and building automation network connectivity with reliable switching recovery capability that is suitable for implementing fault tolerant and mesh network architectures.

IPv4 and IPv6 VLAN Routing for Secure and Flexible Management

The Industrial Managed Switch offers IPv4/IPv6 VLAN routing feature which allows to crossover different VLANs and different IP addresses for the purpose of having a highly-secured, flexible management and simpler networking application.

User-friendly Management Interfaces

For efficient management, the Industrial Managed Switch is equipped with console, Web and SNMP management interfaces. With the built-in web-based management interface, the Industrial Managed Switch offers an easy-to-use, platform independent management and configuration facility. The Industrial Managed Switch supports SNMP which can be managed via any management software based on standard SNMP v1 or v2. For reducing product learning time, the Industrial Managed Switch offers Cisco-like command via Telnet or console port and customer doesn't need to learn new command from these switches. Moreover, the Industrial Managed Switch offers remote secure management by supporting **SSH**, **SSL** and **SNMPv3** connection which can encrypt the packet content at each session.

Intelligent SFP Diagnosis Mechanism

The Industrial Managed Switch supports SFP-DDM (**Digital Diagnostic Monitor**) function that can easily monitor real-time parameters of the SFP for network administrator, such as optical output power, optical input power, temperature, laser bias current, and transceiver supply voltage.

Flexible and Extendable Solution

It features **100BASE-FX** and **1000BASE-SX/LX SFP** (Small Form-factor Pluggable) fiber-optic modules, meaning the administrator now can flexibly choose the suitable SFP transceiver according to the transmission distance or the transmission speed required to extend the network efficiently.

1588 Precision Time Protocol for Industrial Computing Networks

The Industrial Managed Switch is intended for telecom and carrier Ethernet applications, supporting MEF service delivery and timing over packet solutions for the IEEE 1588 Precision Time Protocol and synchronous Ethernet.

1.3 How to Use This Manual

This User's Manual is structured as follows:

Section 2, INSTALLATION

The section explains the functions of the **Industrial Managed Switch** and how to physically install the **Industrial Managed Switch**.

Section 3, SWITCH MANAGEMENT

The section contains the information about the software function of the **Industrial Managed Switch**.

Section 4, WEB CONFIGURATION

The section explains how to manage the **Industrial Managed Switch** by Web interface.

Section 5, SWITCH OPERATION

The chapter explains how to do the switch operation of the **Industrial Managed Switch**.

Section 6, TROUBLESHOOTING

The chapter explains how to do troubleshooting of the **Industrial Managed Switch**.

Appendix A

The section contains cable information of the **Industrial Managed Switch**.

Appendix B

The section contains glossary information of the **Industrial Managed Switch**.

1.4 Product Features

➤ **Physical Port**

- 10/100/1000BASE-T RJ45 copper
- 100/1000BASE-X mini-GBIC/SFP slots, SFP type auto detection
- Console interface for basic management and setup

➤ **Power over Ethernet** (IGS-5225-4UP1T2S)

- Ultra Power over Ethernet end-span/mid-span PSE
- Up to 60 watts of power on 4-pair UTP
- Backward compatible with IEEE 802.3at/af PD device
- Up to 4 ports of IEEE 802.3af/IEEE 802.3at/Ultra PoE devices powered
- Supports PoE power up to 72 watts for each PoE port
- 240-watt PoE budget
- Auto detects powered device (PD)
- Circuit protection prevents power interference between ports
- Remote power feeding up to 100m
- PoE management features
 - Total PoE power budget control
 - Per port PoE function enable/disable
 - PoE admin-mode control
 - PoE port power feeding priority
 - Per PoE port power limit
 - PD classification detection
- Intelligent PoE features
 - Temperature threshold control
 - PoE usage threshold control
 - PD alive check
 - PoE schedule

➤ **Power over Ethernet** (IGS-5225-8P2T2S)

- Complies with IEEE 802.3at Power over Ethernet Plus/end-span PSE
- Up to 8 IEEE 802.3af/802.3at devices powered
- Supports PoE power up to 36 watts for each PoE port
- 240-watt PoE budget
- Auto detects powered device (PD)
- Circuit protection prevents power interference between ports
- Remote power feeding up to 100m
- PoE management features
 - Total PoE power budget control
 - Per port PoE function enable/disable
 - PoE admin-mode control
 - PoE port power feeding priority
 - Per PoE port power limit
 - PD classification detection

- Intelligent PoE features
 - Temperature threshold control
 - PoE usage threshold control
 - PD alive check
 - PoE schedule

- **Power over Ethernet** (IGS-5225-4P2S)
 - Complies with IEEE 802.3at Power over Ethernet Plus/end-span PSE
 - Up to 4 IEEE 802.3af/802.3at devices powered
 - Supports PoE power up to 36 watts for each PoE port
 - Auto detects powered device (PD)
 - Circuit protection prevents power interference between ports
 - Remote power feeding up to 100m
 - PoE management features
 - Total PoE power budget control
 - Per port PoE function enable/disable
 - PoE admin-mode control
 - PoE port power feeding priority
 - Per PoE port power limit
 - PD classification detection
 - Intelligent PoE features
 - Temperature threshold control
 - PoE usage threshold control
 - PD alive check
 - PoE schedule

- **Industrial Protocol**
 - Modbus TCP for real-time monitoring in a SCADA system
 - IEEE 1588v2 PTP (Precision Time Protocol)

- **Industrial Case and Installation**
 - IP30 aluminum case
 - DIN-rail and wall-mount design
 - Redundant power design
 - Supports Ethernet ESD protection for 6000V DC
 - -40 to 75 degrees C operating temperature

- **Industrial Case and Installation** (IGS-5225-4P2S)
 - IP40 metal case
 - DIN-rail and wall-mount designs
 - 48~56V DC, redundant power with polarity reverse protect function
 - Supports 6000V DC Ethernet ESD protection
 - -40 to 75 degrees C operating temperature

➤ **Digital Input and Digital Output**

- 2 Digital Input (DI)
- 2 Digital Output (DO)
- Integrates sensors into auto alarm system
- Transfers alarm to IP network via email and SNMP trap

➤ **Layer 2 Features**

- High performance of Store-and-Forward architecture and runt/CRC filtering eliminates erroneous packets to optimize the network bandwidth
- Storm Control support
 - Broadcast/Multicast/Unknown Unicast
- Supports **VLAN**
 - IEEE 802.1Q tagged VLAN
 - Up to 255 VLANs groups, out of 4095 VLAN IDs
 - Provider Bridging (VLAN Q-in-Q) support (IEEE 802.1ad)
 - Private VLAN Edge (PVE)
 - Protocol-based VLAN
 - MAC-based VLAN
 - Voice VLAN
- Supports **Spanning Tree Protocol**
 - IEEE 802.1D Spanning Tree Protocol (STP)
 - IEEE 802.1w Rapid Spanning Tree Protocol (RSTP)
 - IEEE 802.1s Multiple Spanning Tree Protocol (MSTP) by VLAN
 - BPDU Guard
- Supports **Link Aggregation**
 - 802.3ad Link Aggregation Control Protocol (LACP)
 - Cisco ether-channel (static trunk)
- Provides port mirror (many-to-1)
- Port mirroring of the incoming or outgoing traffic on a particular port
- Loop protection to avoid broadcast loops
- Supports E.R.P.S. (**Ethernet Ring Protection Switching**) (IGS-5225-4UP1T2S/IGS-5225-8P2T2S)
- IEEE 1588 and synchronous Ethernet network timing (IGS-5225-4UP1T2S/IGS-5225-8P2T2S)

➤ **Quality of Service**

- Ingress Shaper and Egress Rate Limit per port bandwidth control
- 8 priority queues on all switch ports
- Traffic classification
 - IEEE 802.1p CoS
 - IP TOS/DSCP/IP Precedence
 - IP TCP/UDP port number
 - Typical network application
- Strict priority and Weighted Round Robin (WRR) CoS policies
- Supports QoS and In/Out bandwidth control on each port
- Traffic-policing policies on the switch port
- DSCP remarking

➤ **Multicast**

- Supports IPv4 IGMP snooping v1, v2 and v3
- Supports IPv6 MLD snooping v1 and v2
- Querier mode support
- IGMP snooping port filtering
- MLD snooping port filtering
- MVR (Multicast VLAN Registration)

➤ **Security**

- Authentication
 - IEEE 802.1x Port-based/MAC-based network access authentication
 - Built-in RADIUS client to cooperate with the RADIUS servers
 - TACACS+ login users access authentication
 - RADIUS/TACACS+ users access authentication
- Access Control List
 - IP-based Access Control List (ACL)
 - MAC-based Access Control List
- Source MAC/IP address binding
- **DHCP snooping** to filter untrusted DHCP messages
- **Dynamic ARP Inspection** discards ARP packets with invalid MAC address to IP address binding
- **IP Source Guard** prevents IP spoofing attacks
- Auto DoS rule to defend DoS attack
- IP address access management to prevent unauthorized intruder

➤ **Layer 3 IP Routing Features**

- Supports static routes and route summarization

➤ **Management**

- IPv4 and IPv6 dual stack management
- Switch Management Interfaces
 - Console/Telnet Command Line Interface
 - Web switch management
 - SNMP v1 and v2c switch management
 - SSH/SSL and SNMP v3 secure access
- **IPv6** IP address/NTP/DNS management
- Built-in Trivial File Transfer Protocol (TFTP) client
- BOOTP and DHCP for IP address assignment
- System Maintenance
 - Firmware upload/download via HTTP/TFTP
 - Reset button for system reboot or reset to factory default
 - Dual Images
- DHCP Relay and DHCP Option82
- User Privilege levels control
- NTP (Network Time Protocol)
- Link Layer Discovery Protocol (LLDP) and LLDP-MED
- SFP-**DDM** (Digital Diagnostic Monitor)
- Network Diagnostic
 - ICMPv6/ICMPv4 Remote Ping
 - Cable Diagnostic technology provides the mechanism to detect and report potential cabling issues
- SMTP/Syslog remote alarm
- Four RMON groups (history, statistics, alarms and events)
- SNMP trap for interfacing Link Up and Link Down notification
- System Log
- PLANET Smart Discovery Utility for deployment management

1.5 Product Specifications

IGS-5225-4T2S/IGS-5225-4UP1T2S

| Product | IGS-5225-8P2T2S | IGS-5225-4UP1T2S |
|--------------------------------|--|---|
| Hardware Specifications | | |
| Copper Ports | 10 10/100/1000BASE-T RJ45 auto-MDI/MDI-X ports | 5 10/100/1000BASE-T RJ45 auto-MDI/MDI-X ports |
| SFP/mini-GBIC Slots | 2 1000BASE-SX/LX/BX SFP interfaces (Port-11 to Port-12) Compatible with 100BASE-FX SFP | 2 1000BASE-SX/LX/BX SFP interfaces (Port-6 to Port-7) Compatible with 100BASE-FX SFP |
| PoE Injector Port | 8 ports with 802.3at/af PoE injector function with Port-1 to Port-8 | 4 ports with Ultra PoE/802.3at/af PoE injector function with Port-1 to Port-4 |
| Console | 1 x RJ45-to-RS232 serial port (115200, 8, N, 1) | |
| Switch Architecture | Store-and-Forward | |
| Switch Fabric | 24Gbps/non-blocking | 14Gbps/non-blocking |
| Throughput (packet per second) | 17.85Mpps@ 64 bytes packet | 10.42Mpps@ 64 bytes packet |
| Address Table | 8K entries, automatic source address learning and aging | |
| Shared Data Buffer | 4Mbits | |
| Flow Control | IEEE 802.3x pause frame for full-duplex Back pressure for half-duplex | |
| Jumbo Frame | 9Kbytes | |
| Reset Button | < 5 sec: System reboot > 5 sec: Factory default | |
| ESD Protection | 6KV DC | |
| Enclosure | IP30 aluminum case | |
| Installation | DIN rail kit and wall-mount kit | |
| Connector | Removable 6-pin terminal block for power input Pin 1/2 for Power 1, Pin 3/4 for fault alarm, Pin 5/6 for Power 2 Removable 6-pin terminal block for DI/DO interface Pin 1/2 for DI 1 & 2, Pin 3/4 for DO 1 & 2, Pin 5/6 for GND | |
| Alarm | One relay output for power failure. Alarm relay current carry ability: 1A @ 24V DC | |
| DI/DO | 2 Digital Input (DI) Level 0: -24V~2.1V ($\pm 0.1V$) Level 1: 2.1V~24V ($\pm 0.1V$) Input load to 24V DC, 10mA max. | |
| | 2 Digital Output (DO) Open collector to 24V DC, 100mA max. | |
| Power Requirements | Dual 48~56V DC (>52V DC for PoE+ output recommended) | |
| LED Indicator | System: Power 1 (Green) Power 2 (Green) Fault Alarm (Red) Ring (Green) Ring Owner (Green) | System: Power 1 (Green) Power 2 (Green) Fault Alarm (Red) Ring (Green) Ring Owner (Green) |

| | | |
|------------------------------|--|--|
| | <p>DIDO (Red)</p> <p>Per 10/100/1000T RJ45 PoE+ Ports:</p> <p>PoE-in-Use (Orange)</p> <p>LNK/ACT (Green)</p> <p>Per SFP Interface:</p> <p>100 LNK/ACT (Orange)</p> <p>1000 LNK/ACT (Green)</p> <p>PoE Usage:</p> <p>60W, 120W, 180W, 240W (Orange)</p> | <p>DIDO (Red)</p> <p>Per 10/100/1000T RJ45 Ports:</p> <p>100 LNK/ACT (Orange)</p> <p>1000 LNK/ACT (Green)</p> <p>Per SFP Interface:</p> <p>100 LNK/ACT (Orange)</p> <p>1000 LNK/ACT (Green)</p> <p>Per PoE Port:</p> <p>Ultra 60W PoE-in-use x 1 (Green)</p> <p>802.3at/af PoE-in-use x1 (Orange)</p> <p>PoE Usage:</p> <p>60W, 120W, 180W, 240W (Green)</p> |
| Power Over Ethernet | | |
| PoE Standard | IEEE 802.3at Power over Ethernet Plus/PSE | IEEE 802.3af/802.3at/802.3bt Ultra PoE PSE |
| PoE Power Supply Type | End-span | End-span/Mid-span/UPoE |
| PoE Power Output | <p>IEEE 802.3af Standard</p> <p>- Per port 48V~51V DC (depending on the power supply), max. 15.4 watts</p> <p>IEEE 802.3at Standard</p> <p>- Per port 51V~56V DC (depending on the power supply), max. 36 watts</p> | <p>IEEE 802.3af Standard</p> <p>- Per port 48V~52V DC (depending on the power supply), max. 15.4 watts</p> <p>IEEE 802.3at Standard</p> <p>- Per port 52V~56V DC (depending on the power supply), max. 36 watts</p> <p>Ultra PoE</p> <p>- Per port 48V~56V DC (depending on the power supply), max. 72 watts</p> |
| Power Pin Assignment | 1/2(+), 3/6(-) | <p>End-span: 1/2(-), 3/6(+)</p> <p>Mid-span: 4/5(+), 7/8(-)</p> <p>UPoE: 1/2(-), 3/6(+), 4/5(+), 7/8(-)</p> |
| PoE Power Budget | 240W maximum (depending on power input) | |
| PoE Ability PD @ 15 watts | 8 | 4 units |
| PoE Ability PD @ 30 watts | 8 | 4 units |
| PoE Ability PD @ 60 watts | 8 | 4 units |
| Layer 2 Function | | |
| Basic Management Interfaces | Console; Telnet; Web browser; SNMP v1, v2c | |
| Secure Management Interfaces | SSH, SSL, SNMP v3 | |
| Port Configuration | <p>Port disable/enable</p> <p>Auto-negotiation 10/100/1000Mbps full and half duplex mode selection</p> <p>Flow control disable/enable</p> | |
| Port Status | Display each port's speed duplex mode, link status, flow control status, auto negotiation status, trunk status | |
| Port Mirroring | <p>TX/RX/both</p> <p>1 to 1 monitor</p> | |
| VLAN | <p>802.1Q tagged based VLAN, up to 255 VLAN groups</p> <p>Q-in-Q tunneling</p> <p>Private VLAN Edge (PVE)</p> <p>MAC-based VLAN</p> <p>Protocol-based VLAN</p> <p>Voice VLAN</p> | |

| | |
|------------------------------|---|
| | MVR (Multicast VLAN Registration) Up to 255 VLAN groups, out of 4095 VLAN IDs |
| Link Aggregation | IEEE 802.3ad LACP/static trunk |
| QoS | Traffic classification based, strict priority and WRR 8-level priority for switching - Port number - 802.1p priority - 802.1Q VLAN tag - DSCP/TOS field in IP packet |
| IGMP Snooping | IGMP (v1/v2/v3) snooping, up to 255 multicast groups IGMP querier mode support |
| MLD Snooping | MLD (v1/v2) snooping, up to 255 multicast groups MLD querier mode support |
| Access Control List | IP-based ACL/MAC-based ACL Up to 123 entries |
| Bandwidth Control | Per port bandwidth control Ingress: 500Kb~1000Mbps Egress: 500Kb~1000Mbps |
| Layer 3 Function | |
| IP Interfaces | Max. 8 VLAN interfaces |
| Routing Table | Max. 32 routing entries |
| Routing Protocols | IPv4 software static routing IPv6 software static routing |
| Standards Conformance | |
| Regulatory Compliance | FCC Part 15 Class A, CE |
| Stability Testing | IEC60068-2-32 (free fall) IEC60068-2-27 (shock) IEC60068-2-6 (vibration) |
| Standards Compliance | IEEE 802.3 10BASE-T IEEE 802.3u 100BASE-TX/100BASE-FX IEEE 802.3z Gigabit SX/LX IEEE 802.3ab Gigabit 1000T IEEE 802.3x flow control and back pressure IEEE 802.3ad port trunk with LACP IEEE 802.1D Spanning Tree Protocol IEEE 802.1w Rapid Spanning Tree Protocol IEEE 802.1s Multiple Spanning Tree Protocol IEEE 802.1p Class of Service IEEE 802.1Q VLAN tagging IEEE 802.1X Port Authentication Network Control IEEE 802.1ab LLDP IEEE 802.3af Power over Ethernet IEEE 802.3at Power over Ethernet Plus IEEE 802.3bt Power over Ethernet ready (IGS-5225-4UP1T2S) RFC 768 UDP RFC 793 TFTP RFC 791 IP RFC 792 ICMP RFC 2068 HTTP |

| | |
|------------------------------|--|
| | RFC 1112 IGMP v1 RFC 2236 IGMP v2 |
| SNMP MIBs | RFC 1213 MIB-II RFC 1493 Bridge MIB RFC 1643 Ethernet MIB RFC 2863 Interface MIB RFC 2665 Ether-Like MIB RFC 2819 RMON MIB (Groups 1, 2, 3 and 9) RFC 2737 Entity MIB RFC 2618 RADIUS Client MIB RFC 2933 IGMP-STD-MIB RFC 3411 SNMP-Frameworks-MIB IEEE 802.1X PAE LLDP MAU-MIB |
| Environment | |
| Operating Temperature | -40 ~ 75 degrees C |
| Storage Temperature | -40 ~ 85 degrees C |
| Humidity | 5 ~ 95% (non-condensing) |

| | |
|---------------------------------------|---|
| Product | IGS-5225-4P2S |
| Hardware Specifications | |
| Copper Ports | 4 10/100/1000BASE-T RJ45 auto-MDI/MDI-X ports |
| SFP/mini-GBIC Slots | 2 1000BASE-SX/LX/BX SFP interfaces (Port-5 to Port-6) Compatible with 100BASE-FX SFP |
| PoE Injector Port | 4 ports with 802.3at/af PoE injector function with Port-1 to Port-8 |
| Console | 1 x RJ45-to-RS232 serial port (115200, 8, N, 1) |
| Switch Architecture | Store-and-Forward |
| Switch Fabric | 12Gbps/non-blocking |
| Throughput (packet per second) | 8.928Mpps@ 64 bytes packet |
| Address Table | 8K entries, automatic source address learning and aging |
| Shared Data Buffer | 4Mbits |
| Flow Control | IEEE 802.3x pause frame for full duplex Back pressure for half duplex |
| Jumbo Frame | 9Kbytes |
| Reset Button | <5 sec: System reboot >5 sec: Factory default |
| ESD Protection | 6KV DC |
| Enclosure | IP40 metal case |
| Installation | DIN-rail kit and wall-mount kit |
| Connector | Removable 6-pin terminal block for power input Pin 1/2 for Power 1, Pin 3/4 for fault alarm, Pin 5/6 for Power 2 |
| Alarm | One relay output for power failure. Alarm relay current carry ability: 1A @ 24V DC |
| LED Indicator | System: Power 1 (Green) |

| | |
|-------------------------------------|--|
| | Power 2 (Green) Fault Alarm (Red) Ring (Green) Ring Owner (Green) Per 10/100/1000T RJ45 PoE+ Ports: PoE-in-Use (Orange) LNK/ACT (Green) Per SFP Interface: 100 LNK/ACT (Orange) 1000 LNK/ACT (Green) |
| Dimensions (W x D x H) | 50 x 87.8 x 135 |
| Weight | 610g |
| Power Requirements | Dual 48~56V DC (>51V DC for PoE+ output recommended) |
| Power Consumption | Max. 6.2 watts/26.76BTU (Power on without any connection) Max. 151.8 watts/520.82BTU (Full loading with PoE function) |
| Power Over Ethernet | |
| PoE Standard | IEEE 802.3at Power over Ethernet Plus/PSE |
| PoE Power Supply Type | End-span |
| PoE Power Output | IEEE 802.3af Standard - Per port 48V~51V DC (depending on the power supply), max. 15.4 watts IEEE 802.3at Standard - Per port 51V~56V DC (depending on the power supply), max. 36 watts |
| Power Pin Assignment | 1/2(+), 3/6(-) |
| PoE Power Budget | Dual power input: 144W maximum (depending on power input) |
| Max. Number of Class 2 PDs | 4 |
| Max. Number of Class 3 PDs | 4 |
| Max. Number of Class 4 PDs | 4 |
| Layer 2 Function | |
| Basic Management Interfaces | Console; Telnet; Web browser; SNMP v1, v2c |
| Secure Management Interfaces | SSH, SSL, SNMP v3 |
| Port Configuration | Port disable/enable Auto-negotiation 10/100/1000Mbps full and half duplex mode selection Flow control disable/enable Power saving mode control |
| Port Status | Display each port's speed duplex mode, link status, flow control status, auto negotiation status, trunk status |
| Port Mirroring | TX/RX/both 1 to 1 monitor |
| VLAN | IEEE 802.1Q tag-based VLAN, up to 255 VLAN groups IEEE 802.1ad Q-in-Q tunneling Private VLAN Edge (PVE) MAC-based VLAN Protocol-based VLAN Voice VLAN MVR (Multicast VLAN Registration) GVRP Up to 255 VLAN groups, out of 4094 VLAN IDs |
| Link Aggregation | IEEE 802.3ad LACP/static trunk Supports 2 trunk groups with 2 ports per trunk group |

| | |
|------------------------------|---|
| QoS | Traffic classification based, strict priority and WRR 8-level priority for switching - Port number - 802.1p priority - 802.1Q VLAN tag - DSCP/TOS field in IP packet |
| IGMP Snooping | IPv4 IGMP (v1/v2/v3) snooping, up to 255 multicast groups IPv4 IGMP querier mode support |
| MLD Snooping | IPv6 MLD (v1/v2) snooping, up to 255 multicast groups IPv6 MLD querier mode support |
| Access Control List | IP-based ACL/MAC-based ACL Up to 123 entries |
| Bandwidth Control | Per port bandwidth control Ingress: 500Kb~1000Mbps Egress: 500Kb~1000Mbps |
| SNMP MIBs | RFC 1213 MIB-II IF-MIB RFC 1493 Bridge MIB RFC 1643 Ethernet MIB RFC 2863 Interface MIB RFC 2665 Ether-Like MIB RFC 2819 RMON MIB (Groups 1, 2, 3 and 9) RFC 2737 Entity MIB RFC 2618 RADIUS Client MIB RFC 2933 IGMP-STD-MIB RFC 3411 SNMP-Frameworks-MIB IEEE 802.1X PAE LLDP MAU-MIB |
| Layer 3 Function | |
| IP Interfaces | Max. 8 VLAN interfaces |
| Routing Table | Max. 32 routing entries |
| Routing Protocols | IPv4 software static routing IPv6 software static routing |
| Standards Conformance | |
| Regulatory Compliance | FCC Part 15 Class A, CE |
| Stability Testing | IEC60068-2-32 (free fall) IEC60068-2-27 (shock) IEC60068-2-6 (vibration) |
| Standards Compliance | IEEE 802.3 10BASE-T IEEE 802.3u 100BASE-TX/100BASE-FX IEEE 802.3z Gigabit SX/LX IEEE 802.3ab Gigabit 1000T IEEE 802.3x flow control and back pressure IEEE 802.3ad port trunk with LACP IEEE 802.1D Spanning Tree Protocol IEEE 802.1w Rapid Spanning Tree Protocol IEEE 802.1s Multiple Spanning Tree Protocol IEEE 802.1p Class of Service IEEE 802.1Q VLAN tagging |

| | |
|------------------------------|--|
| | <p>IEEE 802.1ad Q-in-Q VLAN stacking IEEE 802.1X Port Authentication Network Control IEEE 802.1ab LLDP IEEE 802.3af Power over Ethernet IEEE 802.3at Power over Ethernet Plus IEEE 1588 PTPv2 RFC 768 UDP RFC 793 TFTP RFC 791 IP RFC 792 ICMP RFC 2068 HTTP RFC 1112 IGMP v1 RFC 2236 IGMP v2 ITU G.8032 ERPS Ring</p> |
| Environment | |
| Operating Temperature | -40 ~ 75 degrees C |
| Storage Temperature | -40 ~ 85 degrees C |
| Humidity | 5 ~ 95% (non-condensing) |

2. INSTALLATION

2.1 Hardware Description

The Industrial Managed Switch provides three different running speeds – 10Mbps, 100Mbps and 1000Mbps and automatically distinguishes the speed of incoming connection.

This section describes the hardware features of Industrial Managed Switch. For easier management and control of the Industrial Managed Switch, familiarize yourself with its display indicators and ports. Front panel illustrations in this chapter display the unit LED indicators. Before connecting any network device to the Industrial Managed Switch, read this chapter carefully.

2.1.1 Physical Dimensions

IGS-5225-4UP1T2S

■ IGS-5225-4UP1T2S

- Dimensions (W x D x H) : 72 x 107 x 152mm

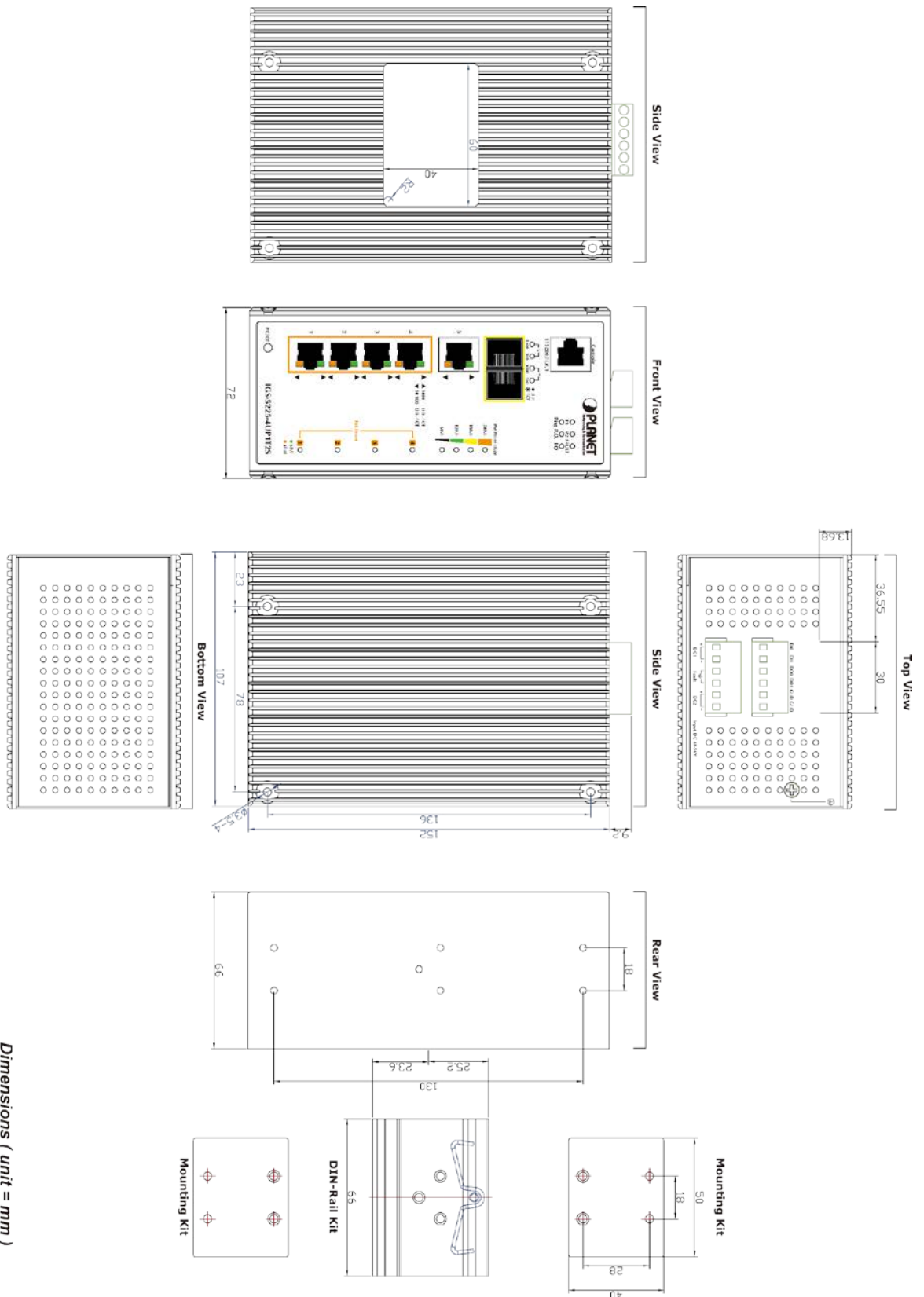

Dimensions (unit = mm)

IGS-5225-8P2T2S

■ IGS-5225-8P2T2S

- Dimensions (W x D x H) : 72 x 107 x 152mm

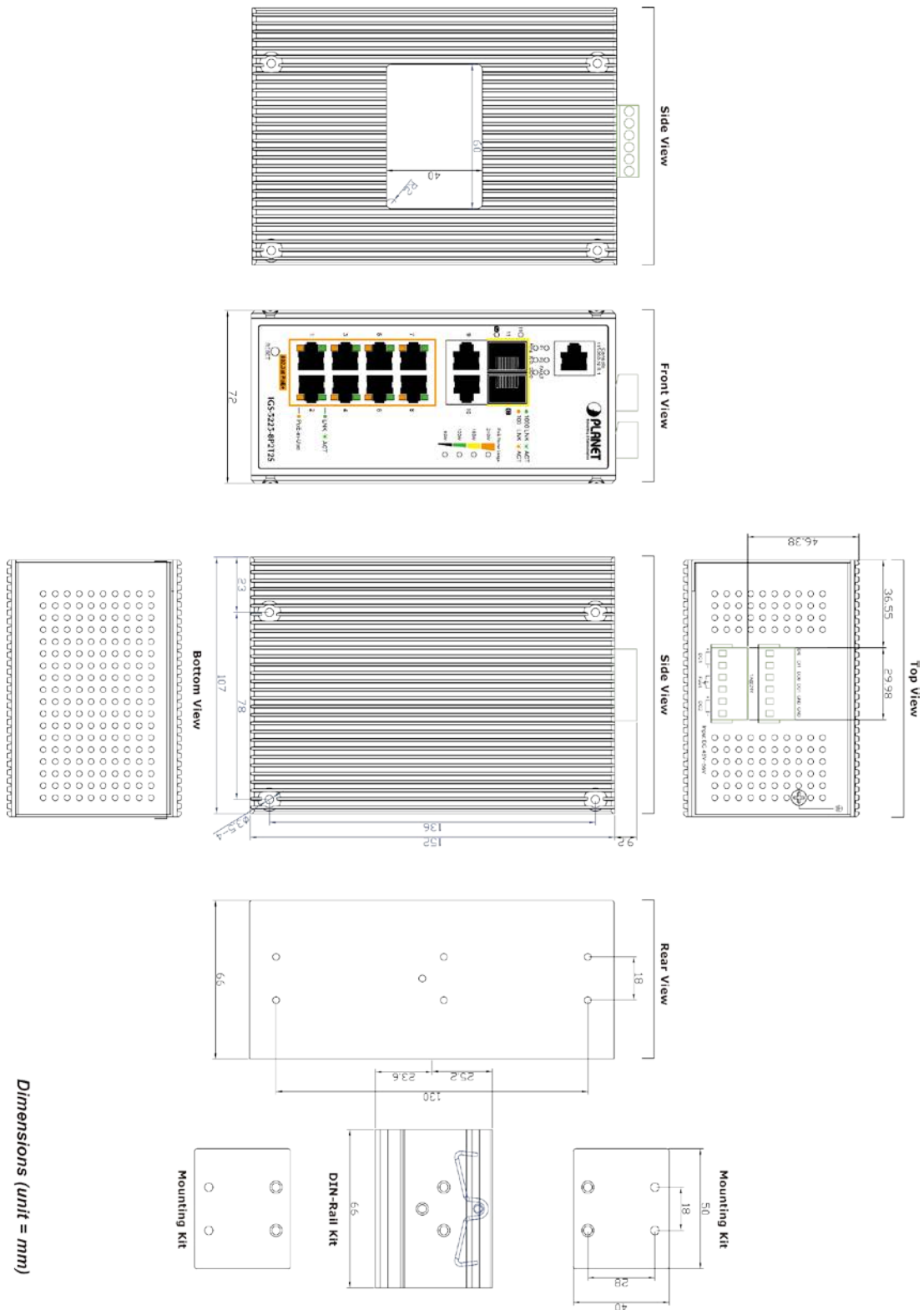

Dimensions (unit = mm)

IGS-5225-4P2S

■ IGS-5225-4P2S

- Dimensions (W x D x H) : 50 x 87.8 x 135 mm

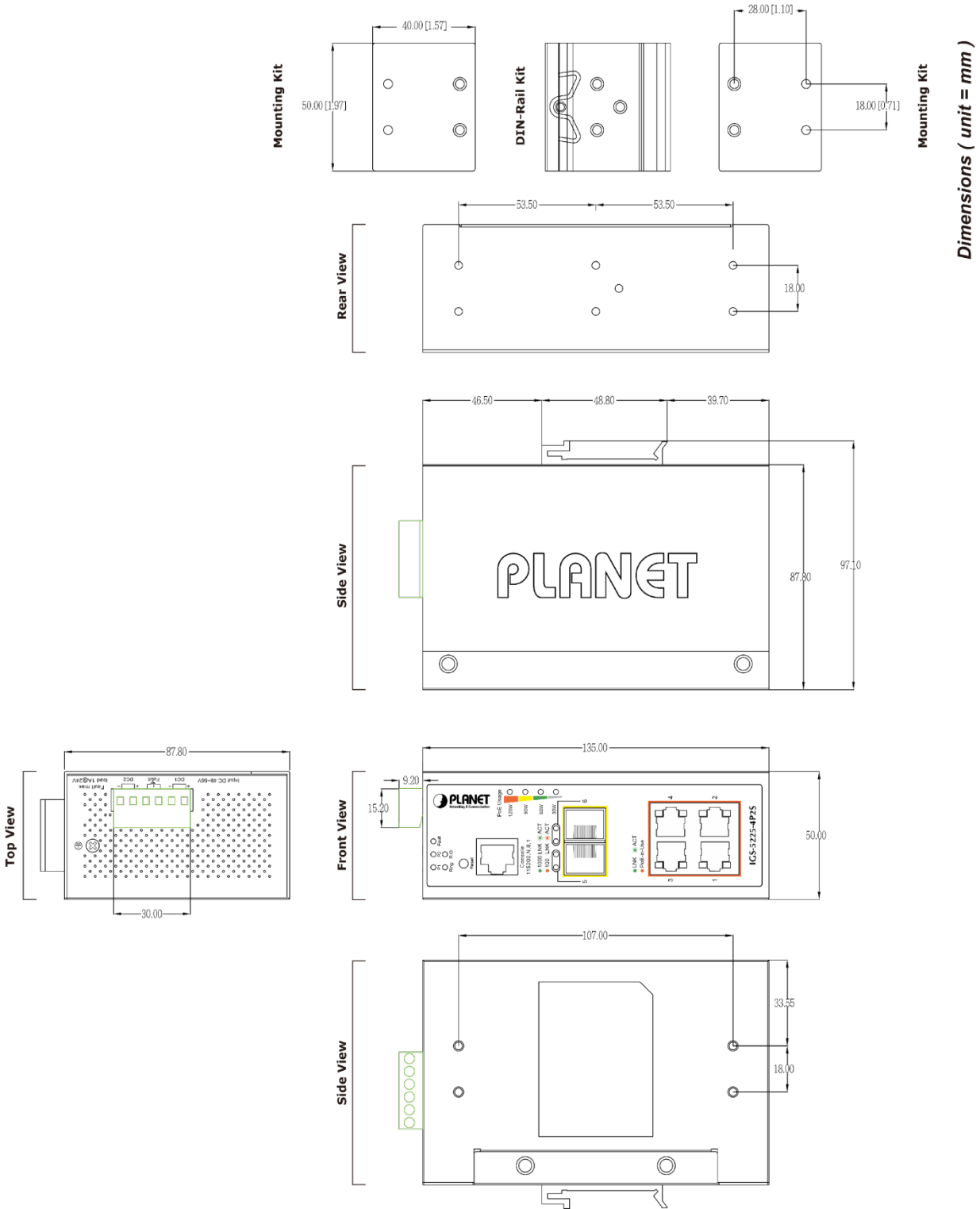

2.1.2 Front Panel

IGS-5225-8P2T2S

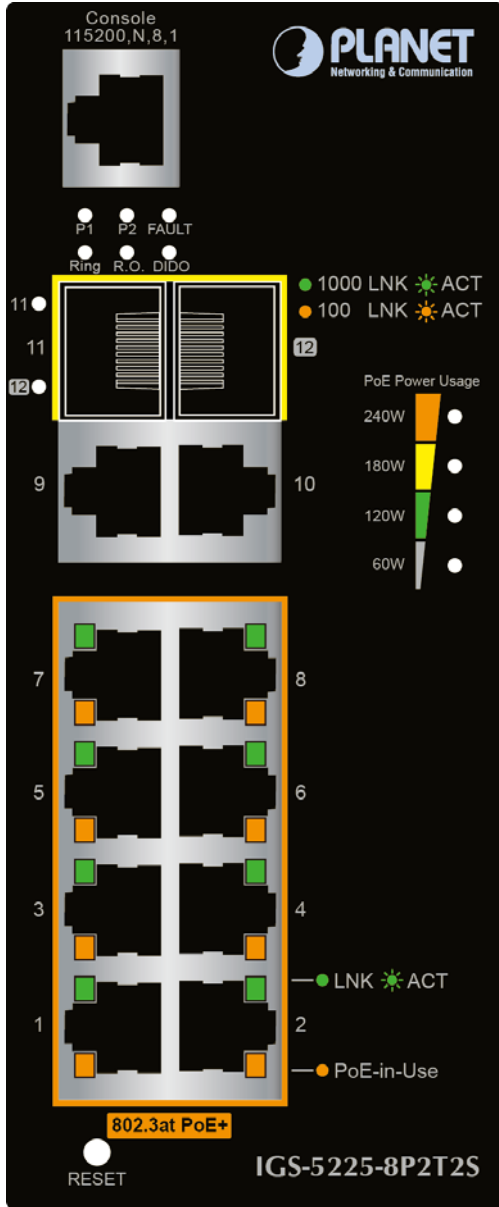

Figure 2-1:

IGS-5225-8P2T2S Switch Front Panel

IGS-5225-4UP1T2S

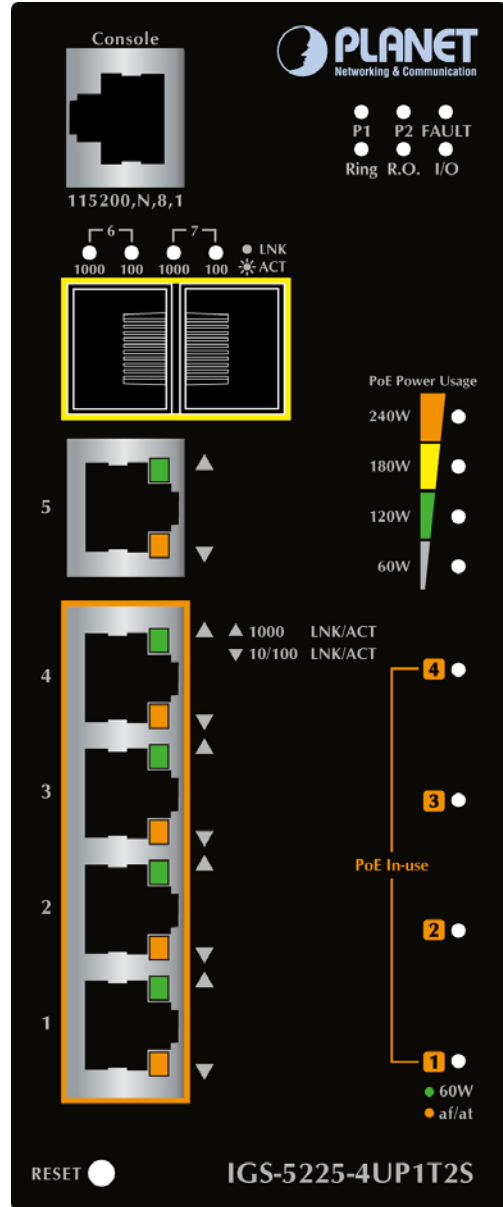

Figure 2-2:

IGS-5225-4UP1T2S Switch Front Panel

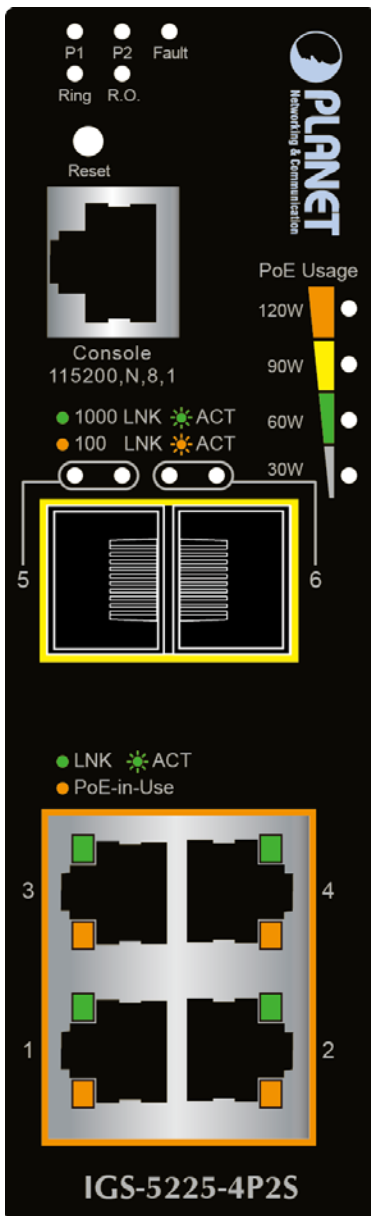

Figure 2-3:

IGS-5225-4P2S Switch Front Panel

Gigabit TP Interface

10/100/1000BASE-T Copper, RJ45 Twisted-pair: Up to 100 meters.

■ SFP Slot

100/1000BASE-X mini-GBIC slot, SFP (Small-form Factor Pluggable) transceiver module: From 550 meters to 2km (multi-mode fiber) and to 10/20/30/40/50/70/120 kilometers (single-mode fiber).

■ Console Port

The console port is an RJ45 port connector. It is an interface for connecting a terminal directly. Through the console port, it provides rich diagnostic information including IP address setting, factory reset, port management, link status and system setting. Users can use the attached DB9 to RJ45 console cable in the package and connect to the console port on the device. After the connection, users can run any terminal emulation program (Hyper Terminal, ProComm Plus, Telix, Winterm and so on) to enter the startup screen of the device.

Reset button

On the upper left side of the front panel, the reset button is designed for rebooting the Industrial Managed Switch without turning off and on the power. The following is the summary table of reset button functions:

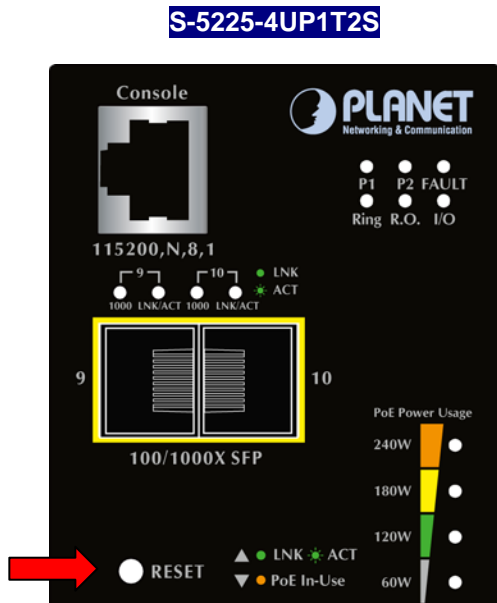

S-5225-4UP1T2S

Figure 2-3:
IGS-5225-4UP1T2S
Reset Button

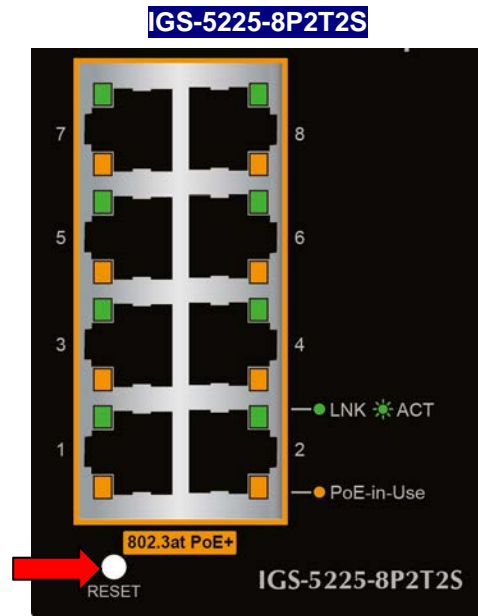

IGS-5225-8P2T2S

Figure 2-4:
IGS-5225-8P2T2S Reset Button

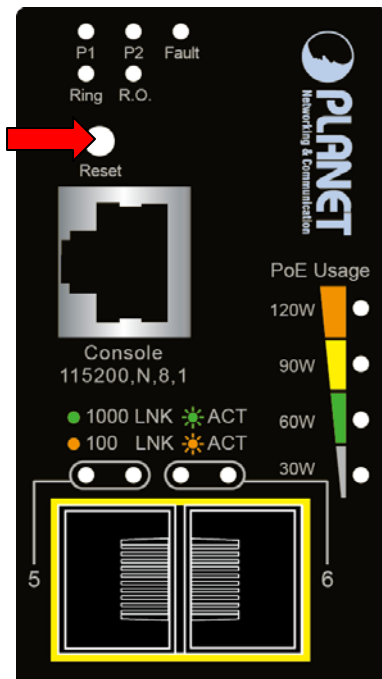

Figure 2-5 IGS-5225-4P2S Reset Button

| Reset Button Pressed and Released | Function |
|-----------------------------------|---|
| < 5 sec: System Reboot | Reboot the Industrial Managed Switch. |
| > 5 sec: Factory Default | Reset the Industrial Managed Switch to Factory Default configuration. The Industrial Managed Switch will then reboot and load the default settings as shown below: <ul style="list-style-type: none">◦ Default Username: admin◦ Default Password: admin◦ Default IP address: 192.168.0.100◦ Subnet mask: 255.255.255.0◦ Default Gateway: 192.168.0.254 |

2.1.3 LED Indications

IGS-5225-4UP1T2S

■ System

| LED | Color | Function |
|-------|-------|---|
| DC1 | Green | Lights to indicate DC power input 1 has power. |
| DC2 | Green | Lights to indicate DC power input 2 has power. |
| Fault | Red | Lights to indicate that Switch DC or port has failed. |
| Ring | Green | Lights to indicate that the ERPS Ring has been created successfully. |
| R.O. | Green | Lights to indicate that Ring state is in idle mode. |
| | | Blinks to indicate that the Ring state is in protected mode. |
| DI/DO | Red | Blinks to indicate that Switch DC or port has failed or DI has event. |

■ Per 10/100/1000BASE-T Port

| LED | Color | Function |
|--------------|--------|---|
| 1000 LNK/ACT | Green | Lights to indicate the port is running in 1000Mbps speed and successfully established. Blinks : indicates that the switch is actively sending or receiving data over that port. |
| 100 LNK/ACT | Orange | Lights to indicate the port is running in 10/100Mbps speed and successfully established. Blinks : indicates that the switch is actively sending or receiving data over that port. |

■ Per SFP Interface

| LED | Color | Function |
|--------------|--------|--|
| 1000 LNK/ACT | Green | Lights to indicate the port is running in 1000Mbps speed and successfully established. Blinks to indicates that the switch is actively sending or receiving data over that port. |
| 100 LNK/ACT | Orange | Lights to indicate the port is running in 100Mbps speed and successfully established. Blinks to indicates that the switch is actively sending or receiving data over that port. |

■ PoE In-use (Port-1~Port-4)

| LED | Color | Function |
|-----|--------|---|
| PoE | Green | Lights to indicate the port is providing DC in-line power with Ultra PoE mode. Off to indicate the connected device is not a PoE Powered Device (PD) |
| | Orange | Lights to indicate the port is providing DC in-line power with End-span/Mid-span mode. Off to indicate the connected device is not a PoE Powered Device (PD) |

■ PoE Power Usage (Unit: Watt)

| LED | Color | Function |
|-----|--------|---|
| 60 | Orange | Lights to indicate the system consumes over 60-watt PoE power budget |
| 120 | Orange | Lights to indicate the system consumes over 120-watt PoE power budget |
| 180 | Orange | Lights to indicate the system consumes over 180-watt PoE power budget |
| 240 | Orange | Lights to indicate the system consumes over 240-watt PoE power budget |

IGS-5225-8P2T2S

■ System

| LED | Color | Function |
|-------|-------|--|
| DC1 | Green | Lights to indicate DC power input 1 has power. |
| DC2 | Green | Lights to indicate DC power input 2 has power. |
| Fault | Red | Lights to indicate that Switch AC/DC or port has failed. |
| Ring | Green | Lights to indicate that the ERPS Ring has been created successfully. |
| R.O. | Green | Lights to indicate that Ring state is in idle mode. |
| | | Blinks to indicate that the Ring state is in protected mode. |
| DI/DO | Red | Blinks to indicate that Switch AC/DC or port has failed or DI has event. |

■ Per 10/100/1000BASE-T Port with PoE (Port-1~Port-8)

| LED | Color | Function |
|------------------------|--------|--|
| 10/100/1000 LNK/ACT | Green | Lights Indicating the port is running at 1000Mbps speed and successfully established. |
| | | Blinks Indicating that the switch is actively sending or receiving data over that port. |
| PoE In-Use | Orange | Lights Indicating the port is providing 48~56V DC in-line power. |
| | | Off Indicating the connected device is not a PoE Powered Device (PD). |

■ Per 10/100/1000BASE-T Port (Port-9~Port-10)

| LED | Color | Function |
|------------------------|--------|--|
| 10/100/1000 LNK/ACT | Green | Lights Indicating the port is running at 1000Mbps speed and successfully established. |
| | | Blinks Indicating that the switch is actively sending or receiving data over that port. |
| 100 LNK/ACT | Orange | Lights Indicating the port is running at 10/100Mbps speed and successfully established. |
| | | Blinks Indicating that the switch is actively sending or receiving data over that port. |

■ Per 100/1000BASE-X SFP Interface (Port-11~Port-12)

| LED | Color | Function |
|-----------------|--------|--|
| 1000 LNK/ACT | Green | Lights Indicating the port is running at 1000Mbps speed and successfully established. |
| | | Blinks Indicating that the switch is actively sending or receiving data over that port. |
| 100 LNK/ACT | Orange | Lights Indicating the port is running at 100Mbps speed and successfully established. |
| | | Blinks Indicating that the switch is actively sending or receiving data over that port. |

■ PoE Power Usage (Unit: Watt)

| LED | Color | Function | |
|-----|--------|----------|--|
| 60 | Orange | Lights: | To indicate the system consumes over 60-watt PoE power budget |
| 120 | Orange | Lights: | To indicate the system consumes over 120-watt PoE power budget |
| 180 | Orange | Lights: | To indicate the system consumes over 180-watt PoE power budget |
| 240 | Orange | Lights: | To indicate the system consumes over 240-watt PoE power budget |

IGS-5225-4P2S

■ System

| LED | Color | Function | |
|-------|-------|--|--|
| DC1 | Green | Lights to indicate DC power input 1 has power. | |
| DC2 | Green | Lights to indicate DC power input 2 has power. | |
| Fault | Red | Lights to indicate that Switch DC or port has failed. | |
| Ring | Green | Lights to indicate that the ERPS Ring has been created successfully. | |
| R.O. | Green | Lights to indicate that Ring state is in idle mode. | |
| | | Blinks to indicate that the Ring state is in protected mode. | |

■ Per 10/100/1000BASE-T Port with PoE (Port-1~Port-4)

| LED | Color | Function | |
|---------|--------|----------|---|
| LNK/ACT | Green | Lights | Indicating the port is running at 10/100/ 1000Mbps speed and successfully established. |
| | | Blinks | Indicating that the switch is actively sending or receiving data over that port. |
| PoE | Orange | Lights | To indicate the port is providing DC in-line power with end-span. |
| | | Off | To indicate the connected device is not a PoE powered device (PD) |

■ Per 100/1000BASE-X SFP Interface (Port-5~Port-6)

| LED | Color | Function | |
|-----------------|--------|----------|---|
| 1000 LNK/ACT | Green | Lights | Indicating the port is running at 1000Mbps speed and successfully established. |
| | | Blinks | Indicating that the switch is actively sending or receiving data over that port. |
| 100 LNK/ACT | Orange | Lights | Indicating the port is running at 100Mbps speed and successfully established. |
| | | Blinks | Indicating that the switch is actively sending or receiving data over that port. |

■ PoE Power Usage (Unit: Watt)

| LED | Color | Function | |
|-----|--------|---------------|--|
| 30 | Orange | Blinks | To indicate the system consumes between 15 watts and 30 watts of PoE power |
| | | Lights | To indicate the system consumes over 30 watts of PoE power |
| 60 | Orange | Blinks | To indicate the system consumes between 45 watts and 60 watts of PoE power |
| | | Lights | To indicate the system consumes over 60 watts of PoE power |
| 90 | Orange | Blinks | To indicate the system consumes between 75 watts and 90 watts of PoE power |
| | | Lights | To indicate the system consumes over 90 watts of PoE power |
| 120 | Orange | Blinks | To indicate the system consumes between 100 watts and 120 watts of PoE power |
| | | Lights | To indicate the system consumes over 120 watts of PoE power |

2.1.4 Switch Upper Panel

The Upper Panel of the **Industrial Managed Switch** comes with a DC inlet power socket and one terminal block connector with 6 contacts.

1. Insert positive/negative DC power wires into contacts 1 and 2 for DC Power 1, or 5 and 6 for DC Power 2.

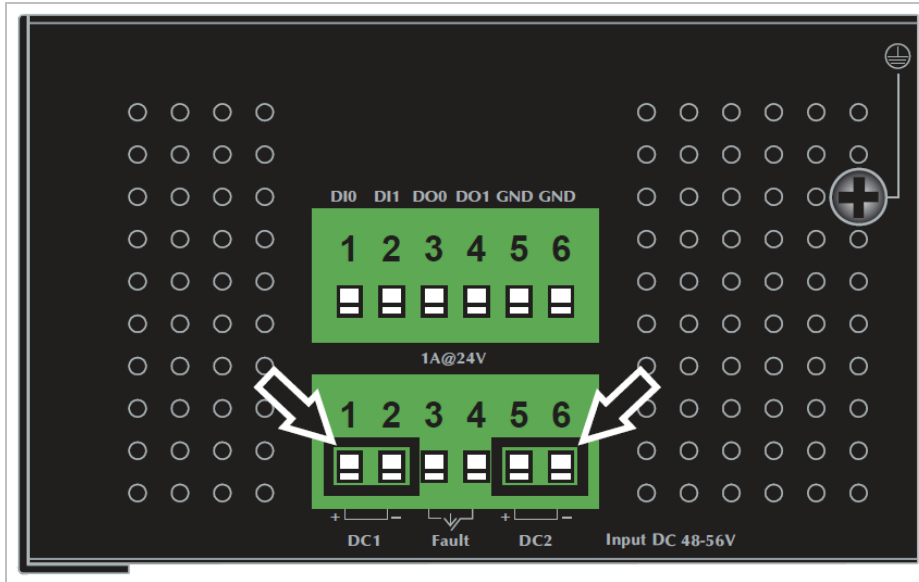

Figure 2-6: Upper Panel

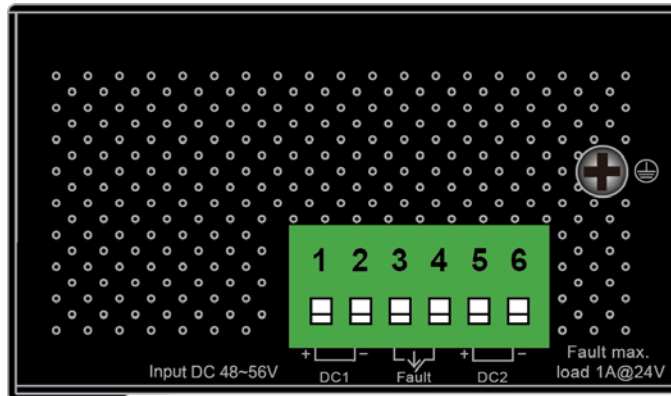

Figure 2-7: IGS-5225-4P2S Upper Panel

- Tighten the wire-clamp screws for preventing the wires from loosening.

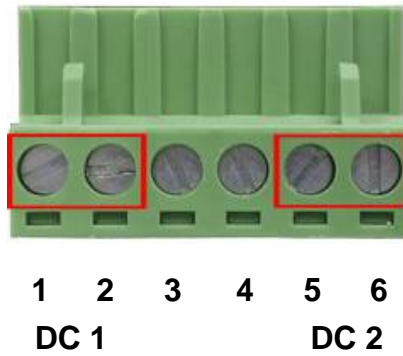

Figure 2-6 6-Pin Terminal Block Power Wiring Input

| Model Name | Positive (+) Pin | Negative (-) Pin | Input Voltage |
|------------------|------------------|------------------|---------------|
| IGS-5225-4UP1T2S | Pin 1/5 | Pin 2/6 | DC 48~56V |
| IGS-5225-8P2T2S | Pin 1/5 | Pin 2/6 | DC 48~56V |
| IGS-5225-4P2S | Pin 1/5 | Pin 2/6 | DC 48~56V |



- The wire gauge for the terminal block should be in the range of 12 ~ 24 AWG@25 degrees C.
- When performing any of the procedures like inserting the wires or tightening the wire-clamp screws, make sure the power is OFF to prevent from getting an electric shock.

2.1.5 Wiring the Fault Alarm Contact

The fault alarm contacts are in the middle (3 & 4) of the terminal block connector as the picture shows below. Inserting the wires, the **Industrial Managed Switch** will detect the fault status of the power failure, or port link failure (available for managed model). The following illustration shows an application example for wiring the fault alarm contacts

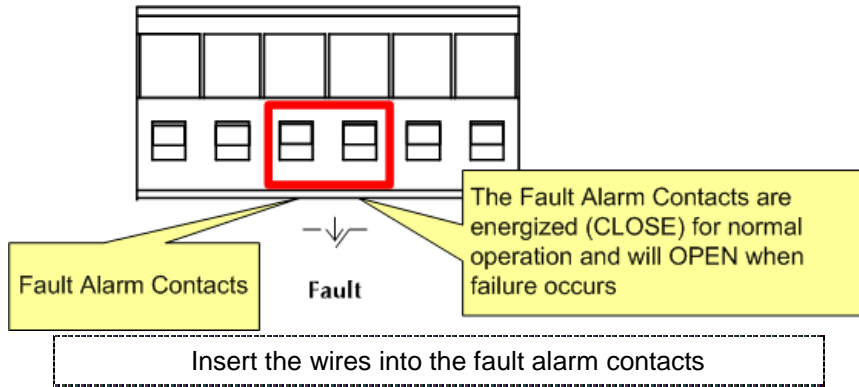

1. The wire gauge for the terminal block should be in the range of 12 ~ 24 AWG.
2. When performing any of the procedures like inserting the wires or tightening the wire-clamp screws, make sure the power is OFF to prevent from getting an electric shock.

2.1.6 Wiring the Digital Input/Output

The 6-contact terminal block connector on the rear panel of IGS Series is used for Digital Input and Digital Output. Please follow the steps below to insert wire.

1. The IGS-5225-4UP1T2S/IGS-5225-8P2T2S offers two DI and DO groups. 1 and 2 are DI groups; 3 and 4 are DO groups; and 5 and 6 are GND (ground).

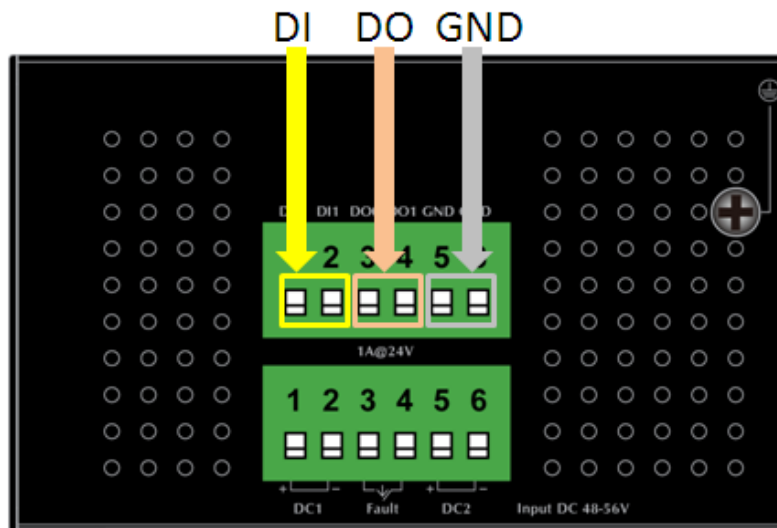

Figure 2-7 Wiring the Redundant Power Inputs

- Tighten the wire-clamp screws for preventing the wires from loosening.

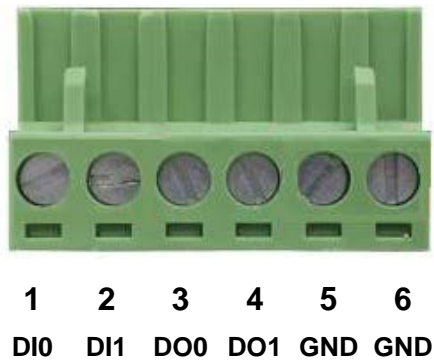

Figure 2-8 6-pin Terminal Block for DI and DO Wiring Input

- There are two Digital Input groups for you to monitor two different devices. The following topology shows how to wire DI0 and DI1.

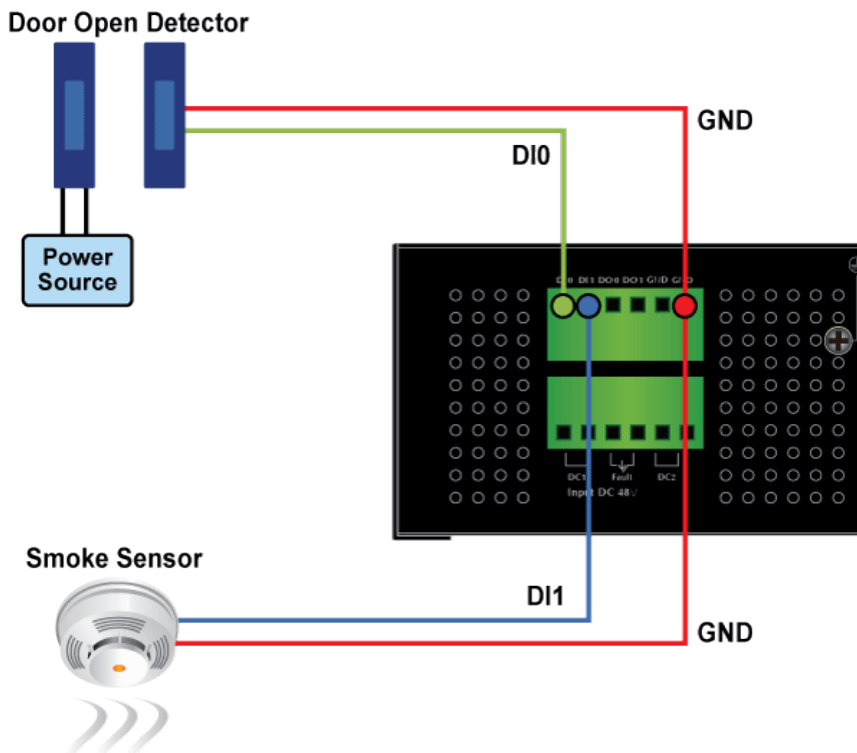

Figure 2-9 Wires DI0 and DI1 to Open Detector

- There are two Digital Output groups for you to sense IGS-5225-4UP1T2S/IGS-5225-8P2T2S port failure or power failure and issue a high or low signal to external device. The following topology shows how to wire DO0 and DO1.

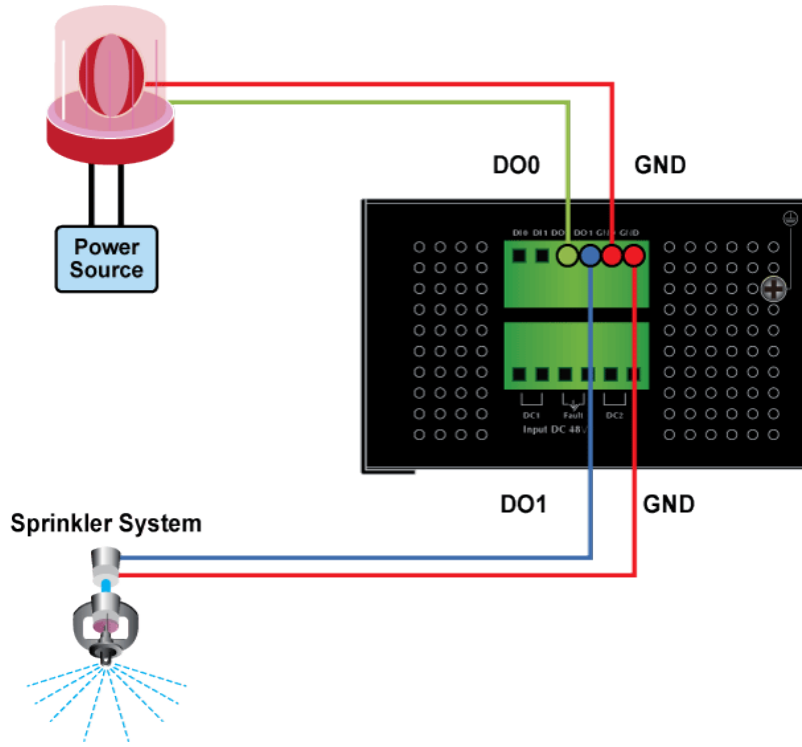

Figure 2-10 Wires DO0 and DO1 to Open Detector

2.2 Installing the Industrial Managed Switch

This section describes how to install your **Industrial Managed Switch** and make connections to the **Industrial Managed Switch**. Please read the following topics and perform the procedures in the order being presented. To install your **Industrial Managed Switch** on a desktop or shelf, simply complete the following steps.

In this paragraph, we will describe how to install the **Industrial Managed Switch** and the installation points attended to it.

2.2.1 Installation Steps

1. **Unpack the Industrial Managed Switch**
2. **Check if the DIN-Rail is screwed on the Industrial Managed Switch or not.** If the DIN-Rail is not screwed on the **Industrial Managed Switch**, please refer to **DIN-rail Mounting** section for DIN-rail installation. If users want to wall-mount the **Industrial Managed Switch**, please refer to the **Wall Mount Plate Mounting** section for wall-mount plate installation.
3. **To hang the Industrial Managed Switch on the DIN-rail track or wall.**
4. **Power on the Industrial Managed Switch.** Please refer to the **Wiring the Power Inputs** section for knowing the information about how to wire the power. The power LED on the **Industrial Managed Switch** will light up. Please refer to the **LED Indicators** section for indication of LED lights.
5. **Prepare the twisted-pair, straight-through Category 5 cable for Ethernet connection.**
6. **Insert one side of RJ45 cable (category 5) into the Industrial Managed Switch Ethernet port** (RJ45 port) while the other side to the network device's Ethernet port (RJ45 port), e.g., Switch PC or Server. The UTP port (RJ45) LED on the **Industrial Managed Switch** will light up when the cable is connected with the network device. Please refer to the **LED Indicators** section for LED light indication.



Make sure that the connected network devices support MDI/MDI-X. If it does not support, use the crossover Category 5 cable.

7. **When all connections are set and all LED lights show normal, the installation is completed.**

2.2.2 DIN-rail Mounting

This section describes how to install the **Industrial Managed Switch**. There are two methods to install the **Industrial Managed Switch** -- DIN-rail mounting and wall-mount plate mounting. Please read the following topics and perform the procedures in the order being presented.



Follow all the DIN-rail installation steps as shown in the example.

Step 1: Screw the DIN-rail on the **Industrial Managed Switch**.



Step 2: Lightly slide the DIN-rail into the track.



Step 3: Check whether the DIN-rail is tightly on the track.

Please refer to the following procedures to remove the **Industrial Managed Switch** from the track.

Step 4: Lightly remove the DIN-rail from the track.



2.2.3 Wall Mount Plate Mounting

To install the **Industrial Managed Switch** on the wall, please follow the instructions below.



Follow all the DIN-rail installation steps as shown in the example.

Step 1: Remove the DIN-rail from the **Industrial Managed Switch**. Use the screwdriver to loosen the screws to remove the DIN-rail.

Step 2: Place the wall-mount plate on the rear panel of the **Industrial Managed Switch**.



Step 3: Use the screwdriver to screw the wall mount plate on the **Industrial Managed Switch**.

Step 4: Use the hook holes at the corners of the wall mount plate to hang the **Industrial Managed Switch** on the wall.

Step 5: To remove the wall mount plate, reverse the steps above.

2.3 Cabling

■ 10/100/1000BASE-T

All 10/100/1000BASE-T ports come with auto-negotiation capability. They automatically support 1000BASE-T, 100BASE-TX and 10BASE-T networks. Users only need to plug a working network device into one of the 10/100/1000BASE-T ports, and then turn on the **Industrial Managed Switch**. The port will automatically run in 10Mbps, 20Mbps, 100Mbps or 200Mbps and 1000Mbps or 2000Mbps after negotiating with the connected device.

■ 100BASE-FX/1000BASE-SX/LX

The **Industrial Managed Switch** has four SFP interfaces that support 100/1000Mbps dual speed mode (optional multi-mode/single-mode 100BASE-FX/1000BASE-SX/LX SFP module)

■ Cabling

Each 10/100/1000BASE-T port uses an RJ45 socket -- similar to phone jacks -- for connection of unshielded twisted-pair cable (UTP). The IEEE 802.3/802.3u 802.3ab Fast/Gigabit Ethernet standard requires Category 5 UTP for 100Mbps 100BASE-TX. 10BASE-T networks can use Cat.3, 4, 5 or 1000BASE-T use 5/5e/6 UTP (see table below). Maximum distance is 100 meters (328 feet). The 100BASE-FX/1000BASE-SX/LX SFP slot uses an LC connector with optional SFP module. Please see table below and know more about the cable specifications.

| Port Type | Cable Type | Connector |
|----------------|---|------------------------|
| 10BASE-T | Cat3, 4, 5, 2-pair | RJ45 |
| 100BASE-TX | Cat5 UTP, 2-pair | RJ45 |
| 1000BASE-T | Cat5/5e/6 UTP, 2-pair | RJ45 |
| 100BASE-FX | 50/125 μ m or 62.5/125 μ m multi-mode 9/125 μ m single-mode | LC (multi/single mode) |
| 1000BASE-SX/LX | 50/125 μ m or 62.5/125 μ m multi-mode 9/125 μ m single-mode | LC (multi/single mode) |
| 10GBASE-SR/LR | 50/125 μ m or 62.5/125 μ m multi-mode 9/125 μ m single-mode | LC (multi/single mode) |

Any Ethernet devices like hubs and PCs can connect to the **Industrial Managed Switch** by using straight-through wires. The two 10/100/1000Mbps ports are auto-MDI/MDI-X and can be used on straight-through or crossover cable.

2.3.1 Installing the SFP Transceiver

The sections describe how to insert an SFP/SFP+ transceiver into an SFP/SFP+ slot. The SFP/SFP+ transceivers are hot-pluggable and hot-swappable. You can plug in and out the transceiver to/from any SFP/SFP+ port without having to power down the **Industrial Managed Switch** as [Figure 2-25](#) appears.



Figure 2-11: Plug in the SFP/SFP+ Transceiver

■ **Approved PLANET SFP/SFP+ Transceivers**

PLANET **Industrial Managed Switch** supports both single mode and multi-mode SFP transceivers. The following list of approved PLANET SFP/SFP+ transceivers is correct at the time of publication:

Fast Ethernet Transceiver (100BASE-X SFP)

| Model | Speed (Mbps) | Connector Interface | Fiber Mode | Distance | Wavelength (nm) | Operating Temp. |
|----------|--------------|---------------------|-------------|----------|-----------------|--------------------|
| MFB-FX | 100 | LC | Multi Mode | 2km | 1310nm | 0 ~ 60 degrees C |
| MFB-F20 | 100 | LC | Single Mode | 20km | 1310nm | 0 ~ 60 degrees C |
| MFB-F40 | 100 | LC | Single Mode | 40km | 1310nm | 0 ~ 60 degrees C |
| MFB-F60 | 100 | LC | Single Mode | 60km | 1310nm | 0 ~ 60 degrees C |
| MFB-F120 | 100 | LC | Single Mode | 120km | 1550nm | 0 ~ 60 degrees C |
| MFB-TFX | 100 | LC | Multi Mode | 2km | 1310nm | -40 ~ 75 degrees C |
| MFB-TF20 | 100 | LC | Single Mode | 20km | 1550nm | -40 ~ 75 degrees C |

Fast Ethernet Transceiver (100BASE-BX, Single Fiber Bi-directional SFP)

| Model | Speed (Mbps) | Connector Interface | Fiber Mode | Distance | Wavelength (TX) | Wavelength (RX) | Operating Temp. |
|-----------|--------------|---------------------|-------------|----------|-----------------|-----------------|--------------------|
| MFB-FA20 | 100 | WDM(LC) | Single Mode | 20km | 1310nm | 1550nm | 0 ~ 60 degrees C |
| MFB-FB20 | 100 | WDM(LC) | Single Mode | 20km | 1550nm | 1310nm | 0 ~ 60 degrees C |
| MFB-TFA20 | 100 | WDM(LC) | Single Mode | 20km | 1310nm | 1550nm | -40 ~ 75 degrees C |
| MFB-TFB20 | 100 | WDM(LC) | Single Mode | 20km | 1550nm | 1310nm | -40 ~ 75 degrees C |
| MFB-TFA40 | 100 | WDM(LC) | Single Mode | 40km | 1310nm | 1550nm | -40 ~ 75 degrees C |
| MFB-TFB40 | 100 | WDM(LC) | Single Mode | 40km | 1550nm | 1310nm | -40 ~ 75 degrees C |

Gigabit Ethernet Transceiver (1000BASE-X SFP)

| Model | Speed (Mbps) | Connector Interface | Fiber Mode | Distance | Wavelength (nm) | Operating Temp. |
|----------|--------------|---------------------|-------------|----------|-----------------|--------------------|
| MGB-GT | 1000 | Copper | -- | 100m | -- | 0 ~ 60 degrees C |
| MGB-SX | 1000 | LC | Multi Mode | 550m | 850nm | 0 ~ 60 degrees C |
| MGB-SX2 | 1000 | LC | Multi Mode | 2km | 1310nm | 0 ~ 60 degrees C |
| MGB-LX | 1000 | LC | Single Mode | 10km | 1310nm | 0 ~ 60 degrees C |
| MGB-L30 | 1000 | LC | Single Mode | 30km | 1310nm | 0 ~ 60 degrees C |
| MGB-L50 | 1000 | LC | Single Mode | 50km | 1550nm | 0 ~ 60 degrees C |
| MGB-L70 | 1000 | LC | Single Mode | 70km | 1550nm | 0 ~ 60 degrees C |
| MGB-L120 | 1000 | LC | Single Mode | 120km | 1550nm | 0 ~ 60 degrees C |
| MGB-TSX | 1000 | LC | Multi Mode | 550m | 850nm | -40 ~ 75 degrees C |
| MGB-TLX | 1000 | LC | Single Mode | 10km | 1310nm | -40 ~ 75 degrees C |
| MGB-TL30 | 1000 | LC | Single Mode | 30km | 1310nm | -40 ~ 75 degrees C |
| MGB-TL70 | 1000 | LC | Single Mode | 70km | 1550nm | -40 ~ 75 degrees C |

Gigabit Ethernet Transceiver (1000BASE-BX, Single Fiber Bi-directional SFP)

| Model | Speed (Mbps) | Connector Interface | Fiber Mode | Distance | Wavelength (TX) | Wavelength (RX) | Operating Temp. |
|-----------|--------------|---------------------|-------------|----------|-----------------|-----------------|--------------------|
| MGB-LA10 | 1000 | WDM(LC) | Single Mode | 10km | 1310nm | 1550nm | 0 ~ 60 degrees C |
| MGB-LB10 | 1000 | WDM(LC) | Single Mode | 10km | 1550nm | 1310nm | 0 ~ 60 degrees C |
| MGB-LA20 | 1000 | WDM(LC) | Single Mode | 20km | 1310nm | 1550nm | 0 ~ 60 degrees C |
| MGB-LB20 | 1000 | WDM(LC) | Single Mode | 20km | 1550nm | 1310nm | 0 ~ 60 degrees C |
| MGB-LA40 | 1000 | WDM(LC) | Single Mode | 40km | 1310nm | 1550nm | 0 ~ 60 degrees C |
| MGB-LB40 | 1000 | WDM(LC) | Single Mode | 40km | 1550nm | 1310nm | 0 ~ 60 degrees C |
| MGB-LA60 | 1000 | WDM(LC) | Single Mode | 60km | 1310nm | 1550nm | 0 ~ 60 degrees C |
| MGB-LB60 | 1000 | WDM(LC) | Single Mode | 60km | 1550nm | 1310nm | 0 ~ 60 degrees C |
| MGB-TLA10 | 1000 | WDM(LC) | Single Mode | 10km | 1310nm | 1550nm | -40 ~ 75 degrees C |
| MGB-TLB10 | 1000 | WDM(LC) | Single Mode | 10km | 1550nm | 1310nm | -40 ~ 75 degrees C |
| MGB-TLA20 | 1000 | WDM(LC) | Single Mode | 20km | 1310nm | 1550nm | -40 ~ 75 degrees C |
| MGB-TLB20 | 1000 | WDM(LC) | Single Mode | 20km | 1550nm | 1310nm | -40 ~ 75 degrees C |
| MGB-TLA40 | 1000 | WDM(LC) | Single Mode | 40km | 1310nm | 1550nm | -40 ~ 75 degrees C |
| MGB-TLB40 | 1000 | WDM(LC) | Single Mode | 40km | 1550nm | 1310nm | -40 ~ 75 degrees C |
| MGB-TLA60 | 1000 | WDM(LC) | Single Mode | 60km | 1310nm | 1550nm | -40 ~ 75 degrees C |
| MGB-TLB60 | 1000 | WDM(LC) | Single Mode | 60km | 1550nm | 1310nm | -40 ~ 75 degrees C |



-
1. It is recommended to use PLANET SFP on the **Industrial Managed Switch**. If you insert an SFP/SFP+ transceiver that is not supported, the **Industrial Managed Switch** will not recognize it.
 2. Please choose the SFP/SFP+ transceiver which can be operated under -40~75 degrees C temperature if the switch device is working in a 0~50 degrees C temperature environment.
-

Connect the fiber cable

1. Attach the duplex LC connector on the network cable to the SFP transceiver.
2. Connect the other end of the cable to a device – switches with SFP installed, fiber NIC on a workstation or a media converter.
3. Check the LNK/ACT LED of the SFP slot on the front of the **Industrial Managed Switch**. Ensure that the SFP transceiver is operating correctly.

2.3.2 Removing the SFP/SFP+ Transceiver

1. Make sure there is no network activity by consulting or checking with the network administrator. Or through the management interface of the switch/converter (if available) to disable the port in advance.
2. Remove the fiber optic cable gently.
3. Turn the lever of the SFP transceiver to a horizontal position.
4. Pull out the module gently through the lever.

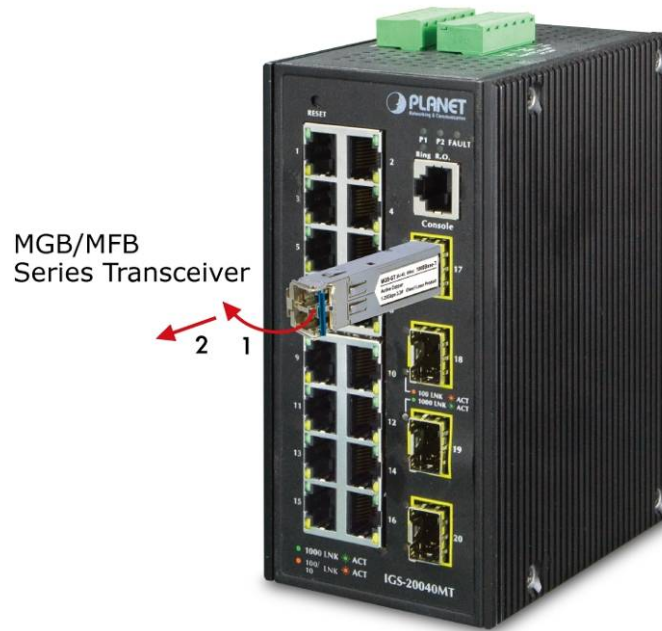

Figure 2-12: Pull out the SFP/SFP+ Transceiver Module



Never pull out the module without pulling the lever or the push bolts on the module. Directly pulling out the module with force could damage the module and SFP module slot of the device.

3. SWITCH MANAGEMENT

This chapter explains the methods that you can use to configure management access to the **Industrial Managed Switch**. It describes the types of management applications and the communication and management protocols that deliver data between your management device (workstation or personal computer) and the system. It also contains information about port connection options.

This chapter covers the following topics:

- Requirements
- Management Access Overview
- Remote Telnet Access
- Web Management Access
- SNMP Access
- Standards, Protocols, and Related Reading

3.1 Requirements

- Workstation running Windows XP/2003, Vista, Windows 7/8/10, MAC OS X, Linux, Fedora, Ubuntu or other platform is compatible with **TCP/IP** protocols.
- **Workstation** is installed with **Ethernet NIC** (Network Interface Card)
- **Serial Port** (Terminal)
 - The above PC comes with COM Port (DB9/RS232) or USB-to-RS232 converter
- Ethernet Port
 - Network cables -- Use standard network (UTP) cables with RJ45 connectors.
- The above workstation is installed with **Web browser** and **JAVA runtime environment** Plug-in



It is recommended to use Internet Explore 8.0 or above to access **Industrial Managed Switch**.

3.2 Management Access Overview

The **Industrial Managed Switch** gives you the flexibility to access and manage it using any or all of the following methods:

- Remote Telnet Interface
- **Web browser** Interface
- An external **SNMP-based network management application**

The remote Telnet and Web browser interfaces are embedded in the **Industrial Managed Switch** software and are available for immediate use. Each of these management methods has their own advantages. Table 3-1 compares the three management methods.

| Method | Advantages | Disadvantages |
|----------------------|--|--|
| Console | <ul style="list-style-type: none"> • No IP address or subnet needed • Text-based • Telnet functionality and HyperTerminal built into Windows 95/98/NT/2000/ME/XP operating systems • ProcommPlus, putty, tera term • Secure | <ul style="list-style-type: none"> • Must be near the switch or use dial-up connection • Not convenient for remote users • Modem connection may prove to be unreliable or slow |
| Remote Telnet | <ul style="list-style-type: none"> • Text-based • Telnet functionality built into Windows XP/2003, Vista, Windows 7 operating systems • Can be accessed from any location | <ul style="list-style-type: none"> • Security can be compromised (hackers need only know the IP address) |
| Web Browser | <ul style="list-style-type: none"> • Ideal for configuring the switch remotely • Compatible with all popular browsers • Can be accessed from any location • Most visually appealing | <ul style="list-style-type: none"> • Security can be compromised (hackers need only know the IP address and subnet mask) • May encounter lag times on poor connections |
| SNMP Agent | <ul style="list-style-type: none"> • Communicates with switch functions at the MIB level • Based on open standards | <ul style="list-style-type: none"> • Requires SNMP manager software • Least visually appealing of all three methods • Some settings require calculations • Security can be compromised (hackers need only know the community name) |

Table 3-1: Management Methods Comparison

3.3 CLI Mode Management

There are two ways for CLI mode management, one is remote telnet and the other operated from console port. Remote telnet is an IP-based protocol and console port is for user to operate the Industrial Managed Switch locally only; however, their operations are the same.

The command line user interface is for performing system administration, such as displaying statistics or changing option settings. When this method is used, you can access the **Industrial Managed Switch** remote telnet interface from personal computer, or workstation in the same Ethernet environment as long as you know the current IP address of the **Industrial Managed Switch**.

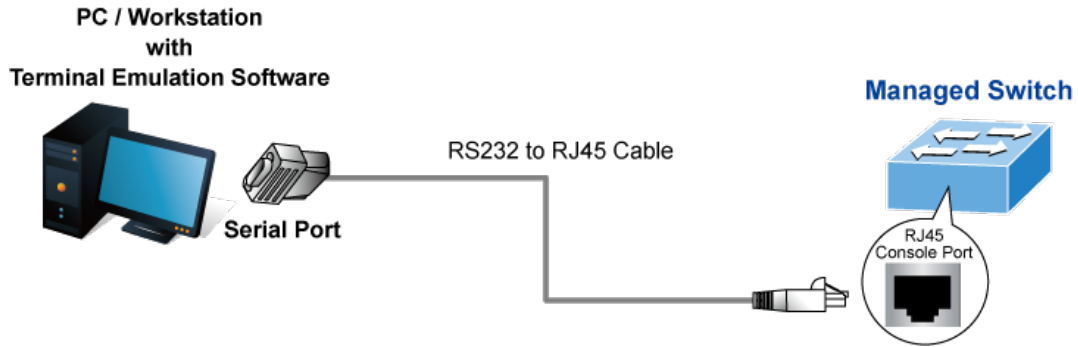

Direct Access

Direct access to the administration console is achieved by directly connecting a terminal or a PC equipped with a terminal-emulation program (such as HyperTerminal, ProcommPlus, putty, tera term) to the Managed Switch console (serial) port. When using this management method, a **straight DB9 RS-232 cable** is required to connect the switch to the PC. After making this connection, configure the terminal-emulation program to use the following parameters:

The default parameters are:

- 115200 bps baud rate
- 8 data bits
- No parity
- 1 stop bit

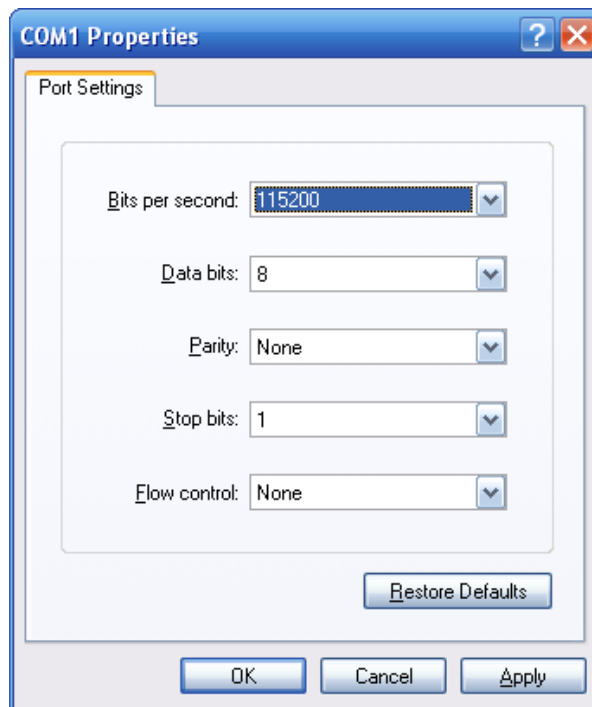

You can change these settings, if desired, after you log on. This management method is often preferred because you can remain connected and monitor the system during system reboots. Also, certain error messages are sent to the serial port, regardless of the interface through which the associated action was initiated. A Macintosh or PC attachment can use any terminal-emulation program for connecting to the terminal serial port. A workstation attachment under UNIX can use an emulator

Remote Telnet

In Windows system, you may click “**Start**” and then choose “**Accessories**” and “**Command Prompt**”. Please input “**telnet 192.168.0.100**” and press “**enter**” from your keyboard. You will see the following screen appears as Figure 3-2 shows.

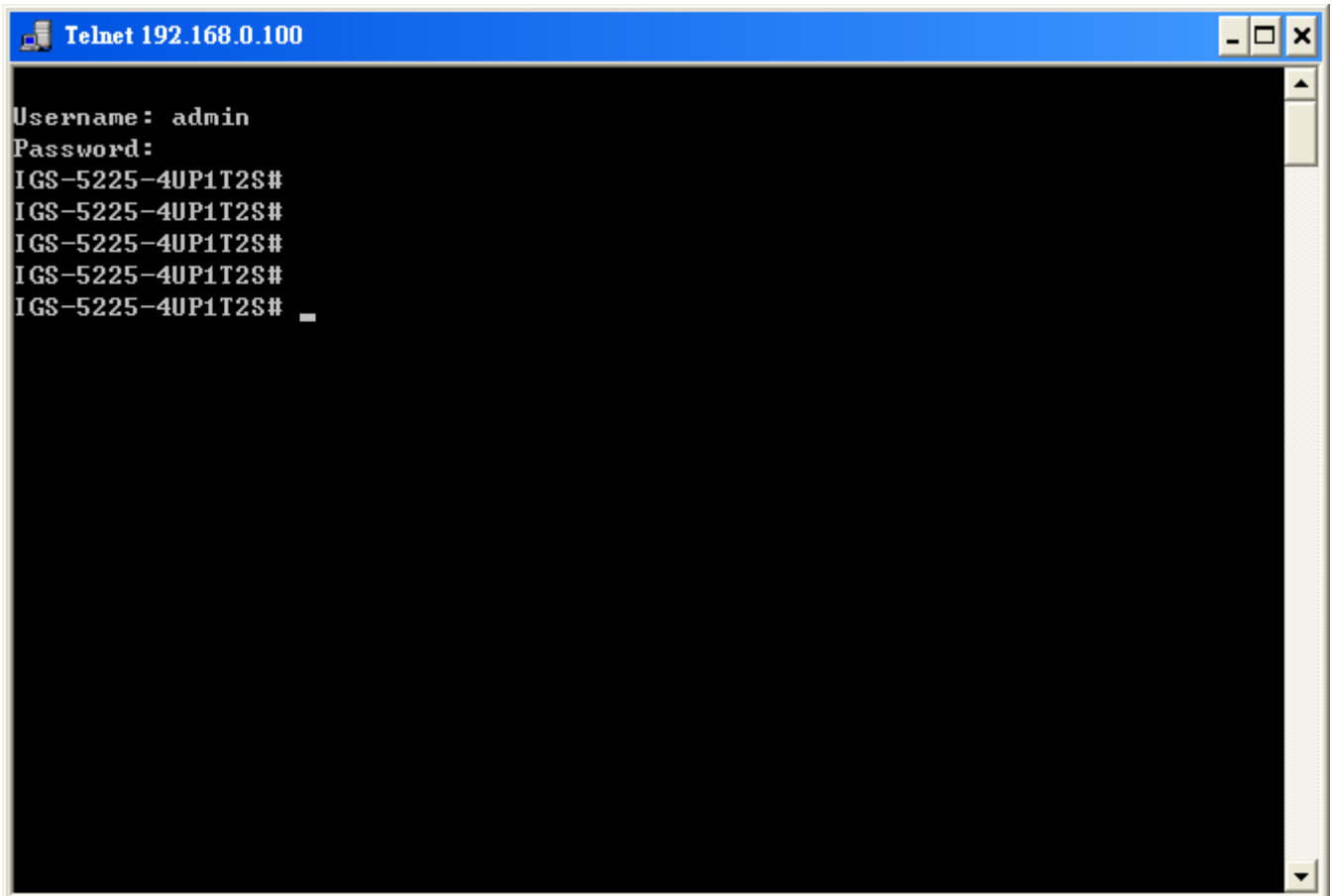

Figure 3-2: Remote Telnet Interface Main Screen of Industrial Managed Switch

3.4 Web Management

The **Industrial Managed Switch** offers management features that allow users to manage the **Industrial Managed Switch** from anywhere on the network through a standard browser such as Microsoft Internet Explorer. After you set up your IP address for the **Industrial Managed Switch**, you can access the **Industrial Managed Switch's** Web interface applications directly in your Web browser by entering the IP address of the **Industrial Managed Switch**.

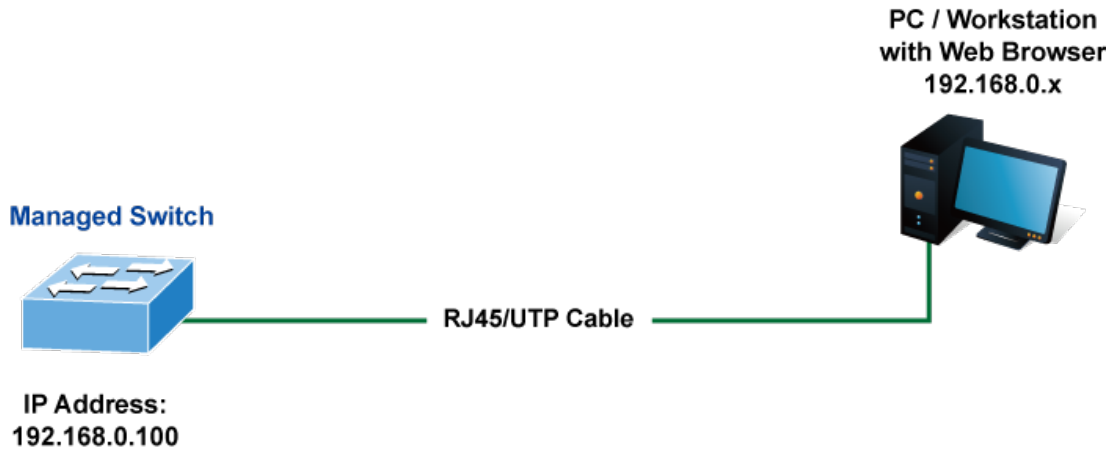

Figure 3-3: Web Management

You can then use your Web browser to list and manage the **Industrial Managed Switch** configuration parameters from one central location; the Web Management requires **Microsoft Internet Explorer 8.0** or later.



Figure 3-4: Web Main Screen of Industrial Managed Switch

3.5 SNMP-based Network Management

You can use an external SNMP-based application to configure and manage the **Industrial Managed Switch**, such as SNMP Network Manager, HP Openview Network Node Management (NNM) or What's Up Gold. This management method requires the SNMP agent on the **Industrial Managed Switch** and the SNMP Network Management Station to use the **same community string**. This management method, in fact, uses two community strings: the **get community string** and the **set community string**.

If the SNMP Network Management Station only knows the set community string, it can read and write to the MIBs. However, if it only knows the get community string, it can only read MIBs. The default gets and sets community strings for the **Industrial Managed Switch** are public.

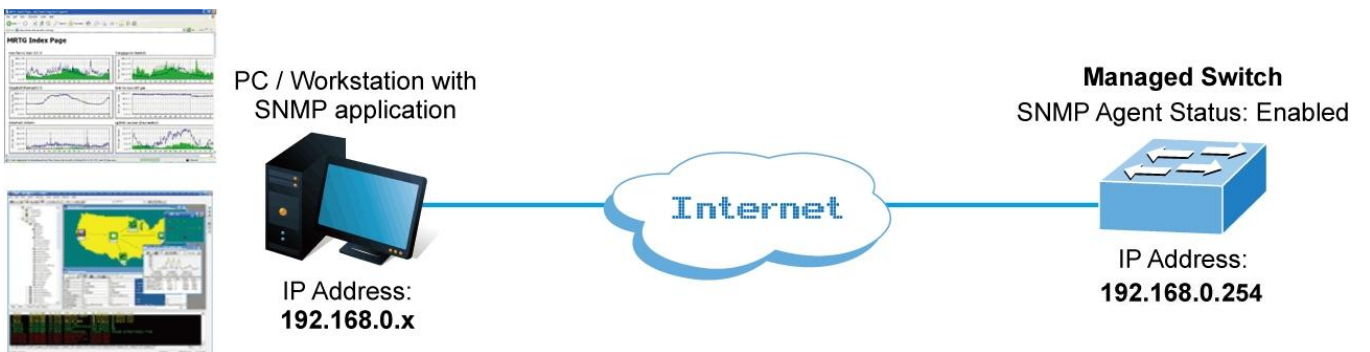

Figure 3-5: SNMP Management

3.6 PLANET Smart Discovery Utility

To easily list the **Industrial Managed Switch** in your Ethernet environment, the Planet Smart Discovery Utility from user's manual CD-ROM is an ideal solution. The following install instructions guide you to running the Planet Smart Discovery Utility.

1. Open the Planet Smart Discovery Utility in administrator PC.
2. Run this utility and the following screen appears.

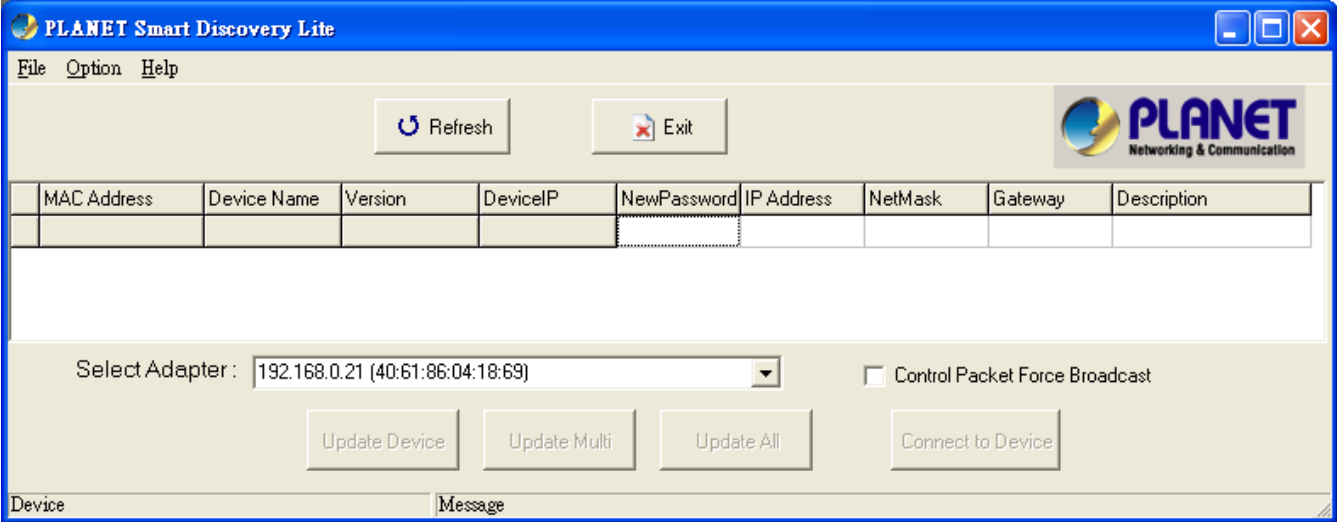

Figure 3-6: Planet Smart Discovery Utility Screen



If there are two LAN cards or above in the same administrator PC, choose a different LAN card by using the **“Select Adapter”** tool.

3. Press the **“Refresh”** button for the currently connected devices in the discovery list as the screen is shown as follows.

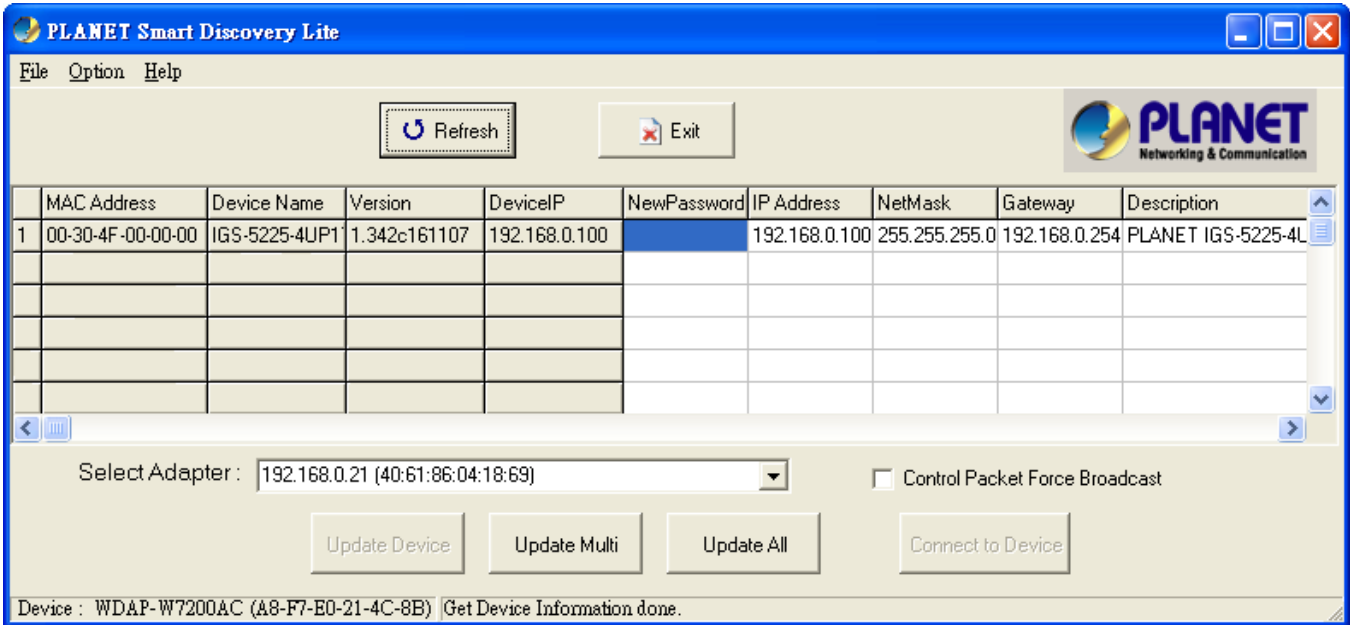

Figure 3-7: Planet Smart Discovery Utility Screen

1. This utility shows all the necessary information from the devices, such as MAC Address, Device Name, firmware version and Device IP Subnet address. A new password, IP Subnet address and description can be assigned to the devices.
2. After setup is completed, press the **“Update Device”**, **“Update Multi”** or **“Update All”** button to take effect. The meanings of the 3 buttons above are shown below:
 - **Update Device:** Use the current setting on one single device.
 - **Update Multi:** Use the current setting on choose multi-devices.
 - **Update All:** Use the current setting on whole devices in the list.The same functions mentioned above also can be found in **“Option”** tools bar.
3. To click the **“Control Packet Force Broadcast”** function, it allows new setting value to be assigned to the Web Smart Switch under a different IP subnet address.
4. Press the **“Connect to Device”** button and then the Web login screen appears in [Figure 3-7](#).
5. Press the **“Exit”** button to shut down Planet Smart Discovery Utility.

4. WEB CONFIGURATION

This section introduces the configuration and functions of the Web-based management.

About Web-based Management

The **Industrial Managed Switch** offers management features that allow users to manage the **Industrial Managed Switch** from anywhere on the network through a standard browser such as Microsoft Internet Explorer.

The Web-based Management supports Internet Explorer 8.0. It is based on Java Applets with an aim to reducing network bandwidth consumption, enhancing access speed and presenting an easy viewing screen.



By default, IE7.0 or later version does not allow Java Applets to open sockets. The user has to explicitly modify the browser setting to enable Java Applets to use network ports.

The **Industrial Managed Switch** can be configured through an Ethernet connection, making sure the manager PC must be set on same the IP subnet address with the **Industrial Managed Switch**.

For example, the default IP address of the **Industrial Managed Switch** is **192.168.0.100**, then the manager PC should be set at **192.168.0.x** (where x is a number between 1 and 254, except 100), and the default subnet mask is 255.255.255.0.

If you have changed the default IP address of the **Industrial Managed Switch** to 192.168.1.1 with subnet mask 255.255.255.0 via console, then the manager PC should be set at 192.168.1.x (where x is a number between 2 and 254) to do the related configuration on manager PC.

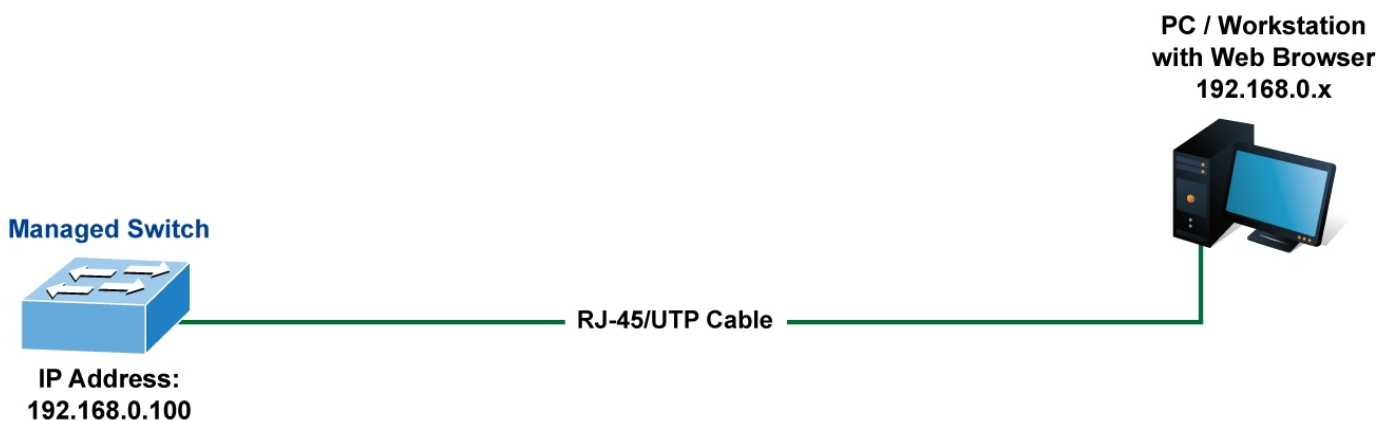

Figure 4-1-1: Web Management

■ Logging on the Industrial Managed Switch

1. Use Internet Explorer 7.0 or above Web browser. Enter the factory-default IP address to access the Web interface. The factory-default IP address is as follows:

<http://192.168.0.100>

- When the following login screen appears, please enter the default username "**admin**" with password "**admin**" (or the username/password you have changed via console) to login the main screen of **Industrial Managed Switch**. The login screen in [Figure 4-1-2](#) appears.



Figure 4-1-2: Login Screen

Default User name: **admin**

Default Password: **admin**

After entering the username and password, the main screen appears as [Figure 4-1-3](#).



Figure 4-1-3: Default Main page

Now, you can use the Web management interface to continue the switch management or manage the **Industrial Managed Switch** by Web interface. The Switch Menu on the left of the web page lets you access all the commands and statistics the Industrial Managed Switch provides.



1. It is recommended to use Internet Explore 8.0 or above to access **Industrial Managed Switch**.
2. The changed IP address takes effect immediately after clicking on the **Save** button. From now on, you need to use the new IP address to access the Internet.



3. For security reason, please change and memorize the new password after this first setup.
4. Only accept command in lowercase letter.

| Web Configuration | 10Gigabit Ethernet | PoE+ | UPoE | E.R.P.S (Ring) | DIDO |
|-------------------------|--------------------|------|------|----------------|------|
| IGS-5225-8P2T2S | - | ■ | - | ■ | ■ |
| IGS-5225-4UP1T2S | - | ■ | ■ | ■ | ■ |
| IGS-5225-4P2S | - | ■ | - | ■ | - |

■ = Supported, - = Not supported

4.1 Main Web page

The **Industrial Managed Switch** provides a Web-based browser interface for configuring and managing it. This interface allows you to access the **Industrial Managed Switch** using the Web browser of your choice. This chapter describes how to use the **Industrial Managed Switch's** Web browser interface to configure and manage it.

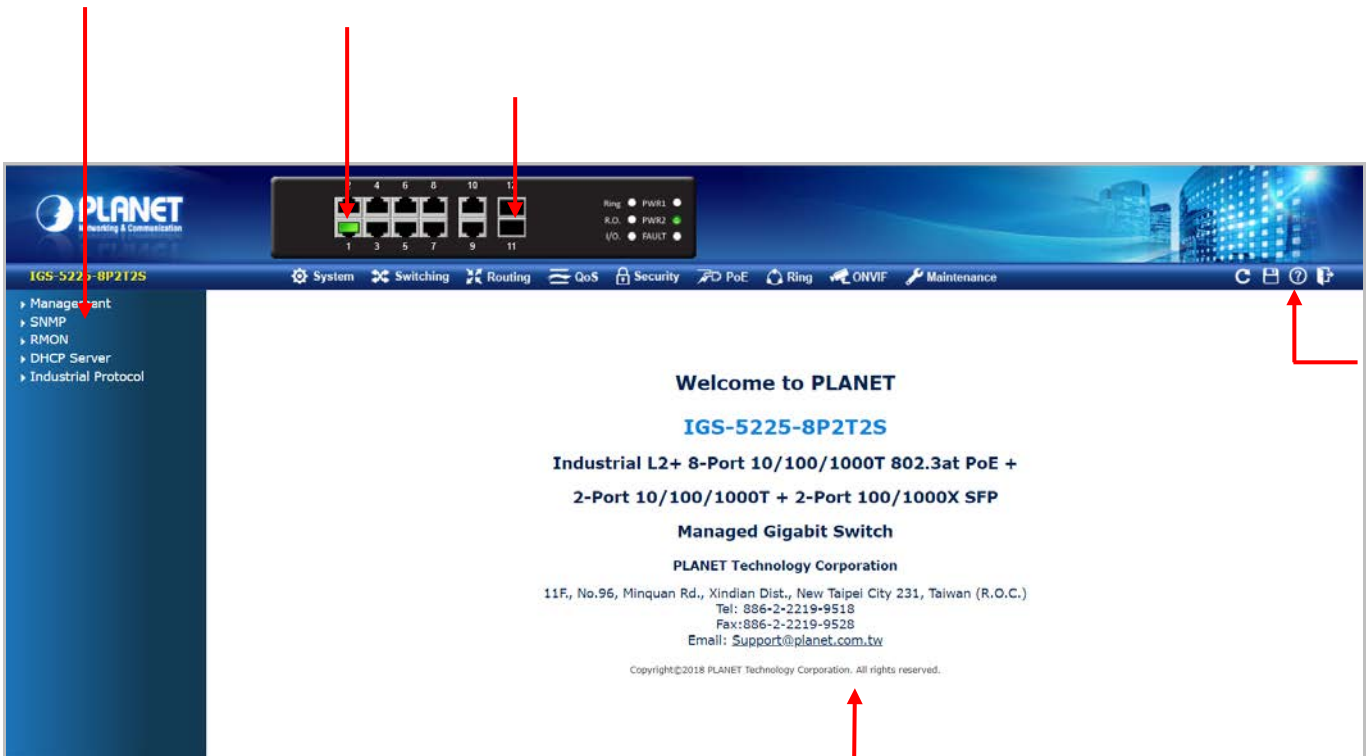

Figure 4-1-4: Main page

Panel Display

The web agent displays an image of the **Industrial Managed Switch's** ports. The Mode can be set to display different information for the ports, including Link up or Link down. Clicking on the image of a port opens the **Port Statistics** page.

The port states are illustrated as follows:

| State | Disabled | Down | Link |
|------------|---|---|---|
| RJ45 Ports |  |  |  |
| SFP Ports |  |  |  |

Main Menu

Using the onboard web agent, you can define system parameters, manage and control the **Industrial Managed Switch**, and all its ports, or monitor network conditions. Via the Web-Management, the administrator can set up the **Industrial Managed Switch** by selecting the functions those listed in the Main Function. The screen in [Figure 4-1-5](#) appears.

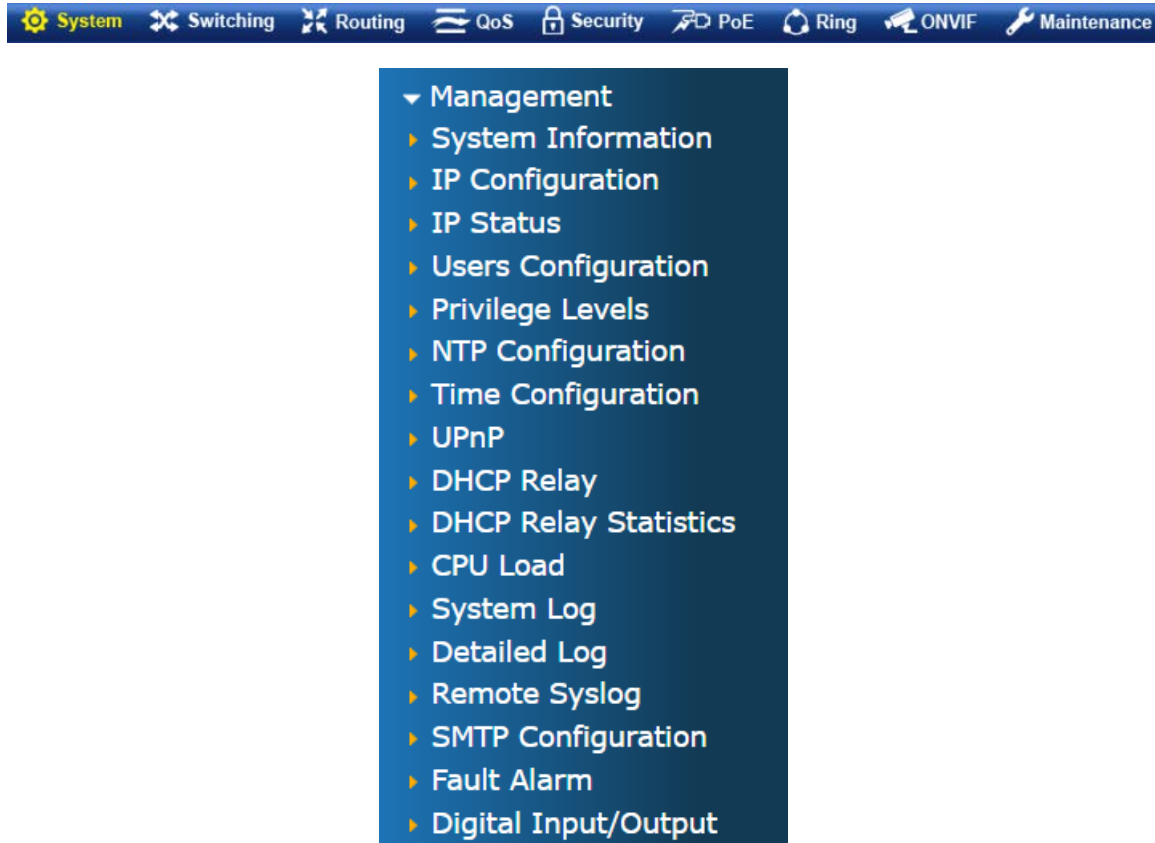

Figure 4-1-5: Industrial Managed Switch Main Functions Menu

4.2 System

Use the System menu items to display and configure basic administrative details of the **Industrial Managed Switch**. Under the System, the following topics are provided to configure and view the system information. This section has the following items:

- **System Information** The **Industrial Managed Switch** system information is provided here.
- **IP Configuration** Configure the IPv4/IPv6 interface and IP routes of the **Industrial Managed Switch** on this page.
- **IP Status** This page displays the status of the IP protocol layer. The status is defined by the IP interfaces, the IP routes and the neighbor cache (ARP cache) status.
- **Users Configuration** This page provides an overview of the current users. Currently the only way to login as another user on the web server is to close and reopen the browser.

- **Privilege Levels** This page provides an overview of the privilege levels.
- **NTP Configuration** Configure NTP server on this page.
- **Time Configuration** Configure time parameter on this page.
- **UPnP** Configure UPnP on this page.
- **DHCP Relay** Configure DHCP Relay on this page.
- **DHCP Relay Statistics** This page provides statistics for DHCP relay.
- **CPU Load** This page displays the CPU load, using an SVG graph.
- **System Log** The system log information of the **Industrial Managed Switch** system is provided here.

- **Detailed Log** The detailed log information of the **Industrial Managed Switch** system is provided here.

- **Remote Syslog** Configure remote syslog on this page.
- **SMTP Configuration** Configure SMTP parameters on this page.
- **Digital Input/Output** Configuration digital input and output on this page.
- **Fault Alarm** Configuration fault alarm on this page.
- **SNMP** Configure SNMP parameters on this page
- **RMON** Configure the RMON parameters on this page
- **DHCP server** Configure the DHCP server on this page
- **Industrial Protocol** Configure the Modbus TCP Mode on this page

4.2.1 Management

4.2.1.1 System Information

The System Information page provides information for the current device information. System Information page helps a switch administrator to identify the hardware MAC address, software version and system uptime. The screen in [Figure 4-2-1](#) appears.

| System Information | |
|-------------------------|-------------------------------|
| System | |
| Contact | |
| Name | IGS-5225-8P2T2S |
| Location | |
| Hardware | |
| MAC Address | 00-30-4f-11-22-74 |
| Power Status | DC PWR1 :OFF DC PWR2 :ON |
| Temperature | 45.0 C - 113.0 F |
| Time | |
| System Date | 1970-01-01 Thu 00:45:23+00:00 |
| System Uptime | 0d 00:45:23 |
| Software | |
| Software Version | 1.440180704 |
| Software Date | 2018-07-05T11:49:46+08:00 |

Auto-refresh

Figure 4-2-1: System Information Page Screenshot

The page includes the following fields:

| Object | Description |
|---------------------------|--|
| • Contact | The system contact configured in SNMP System Information System Contact. |
| • Name | The system name configured in SNMP System Information System Name. |
| • Location | The system location configured in SNMP System Information System Location. |
| • MAC Address | The MAC Address of this Industrial Managed Switch . |
| • Power Status | The status of power input |
| • Temperature | Indicates chipset temperature. |
| • System Date | The current (GMT) system time and date. The system time is obtained through the configured NTP Server, if any. |
| • System Uptime | The period of time the device has been operational. |
| • Software Version | The software version of the Industrial Managed Switch . |
| • Software Date | The date when the Industrial Managed Switch software was produced. |

Buttons

Auto-refresh : Check this box to refresh the page automatically. Automatic refresh occurs every 3 seconds.

Refresh: Click to refresh the page; any changes made locally will be undone.

4.2.1.2 IP Configuration

The IP Configuration includes the IP Configuration, IP Interface and IP Routes. The configured column is used to view or change the IP configuration. The maximum number of interfaces supported is 128 and the maximum number of routes is 32.

The screen in [Figure 4-2-2](#) appears.

IP Configuration

| | |
|-------------|--------------------------|
| Domain Name | No Domain Name |
| Mode | Host |
| DNS Server | No DNS server |
| DNS Proxy | <input type="checkbox"/> |

IP Interfaces

| Delete | VLAN | Enable | Client ID | | | | Hostname | Fallback | Current Lease | IPv4 | | DHCPv6 | | | IPv6 | |
|--------------------------|------|--------------------------|-----------|--------|-------|-----|----------|----------|---------------|---------------|-------------|--------------------------|--------------------------|---------------|---------|-------------|
| | | | Type | IFMac | ASCII | HEX | | | | Address | Mask Length | Enable | Rapid Commit | Current Lease | Address | Mask Length |
| <input type="checkbox"/> | 1 | <input type="checkbox"/> | Auto | Port 1 | | | | | 0 | 192.168.0.100 | 24 | <input type="checkbox"/> | <input type="checkbox"/> | | | |

[Add Interface](#)

IP Routes

| Delete | Network | Mask Length | Gateway | Next Hop VLAN |
|--------------------------|---------|-------------|---------|---------------|
| <input type="checkbox"/> | | | | |

[Add Route](#)

[Apply](#) [Reset](#)

Figure 4-2-2: IP Configuration Page Screenshot

The current column is used to show the active IP configuration.

| Object | Description | | | | |
|--|---|-------------|---|-------------------|---|
| <ul style="list-style-type: none"> • IP Configurations | <table border="1" style="width: 100%; border-collapse: collapse;"> <tr> <td style="width: 20%;">Mode</td> <td>Configure whether the IP stack should act as a Host or a Router. In Host mode, IP traffic between interfaces will not be routed. In Router mode traffic is routed between all interfaces.</td> </tr> <tr> <td>DNS Server</td> <td> <p>This setting controls the DNS name resolution done by the switch.</p> <p>There are four servers available for configuration, and the index of the server presents the preference (less index has higher priority) in doing DNS name resolution.</p> <p>System selects the active DNS server from configuration in turn, if the preferred server does not respond in five attempts.</p> <p>The following modes are supported:</p> <ul style="list-style-type: none"> ■ No DNS server No DNS server will be used. ■ Configured IPv4 Explicitly provide the valid IPv4 unicast address of the DNS Server in dotted decimal notation. Make sure the configured DNS server could be </td> </tr> </table> | Mode | Configure whether the IP stack should act as a Host or a Router. In Host mode, IP traffic between interfaces will not be routed. In Router mode traffic is routed between all interfaces. | DNS Server | <p>This setting controls the DNS name resolution done by the switch.</p> <p>There are four servers available for configuration, and the index of the server presents the preference (less index has higher priority) in doing DNS name resolution.</p> <p>System selects the active DNS server from configuration in turn, if the preferred server does not respond in five attempts.</p> <p>The following modes are supported:</p> <ul style="list-style-type: none"> ■ No DNS server No DNS server will be used. ■ Configured IPv4 Explicitly provide the valid IPv4 unicast address of the DNS Server in dotted decimal notation. Make sure the configured DNS server could be |
| Mode | Configure whether the IP stack should act as a Host or a Router. In Host mode, IP traffic between interfaces will not be routed. In Router mode traffic is routed between all interfaces. | | | | |
| DNS Server | <p>This setting controls the DNS name resolution done by the switch.</p> <p>There are four servers available for configuration, and the index of the server presents the preference (less index has higher priority) in doing DNS name resolution.</p> <p>System selects the active DNS server from configuration in turn, if the preferred server does not respond in five attempts.</p> <p>The following modes are supported:</p> <ul style="list-style-type: none"> ■ No DNS server No DNS server will be used. ■ Configured IPv4 Explicitly provide the valid IPv4 unicast address of the DNS Server in dotted decimal notation. Make sure the configured DNS server could be | | | | |

| | | | |
|-----------------------|------------------|--|---|
| | | <p>reachable (e.g. via PING) for activating DNS service.</p> <ul style="list-style-type: none"> ■ Configured IPv6 Explicitly provide the valid IPv6 unicast (except linklocal) address of the DNS Server. Make sure the configured DNS server could be reachable (e.g. via PING6) for activating DNS service. ■ From any DHCPv4 interfaces The first DNS server offered from a DHCPv4 lease to a DHCPv4-enabled interface will be used. ■ From this DHCPv4 interface Specify from which DHCPv4-enabled interface a provided DNS server should be preferred. ■ From any DHCPv6 interfaces The first DNS server offered from a DHCPv6 lease to a DHCPv6-enabled interface will be used. ■ From this DHCPv6 interface Specify from which DHCPv6-enabled interface a provided DNS server should be preferred | |
| | DNS Proxy | When DNS proxy is enabled, system will relay DNS requests to the currently configured DNS server, and reply as a DNS resolver to the client devices on the network. | |
| • IP Interface | Delete | Select this option to delete an existing IP interface. | |
| | VLAN | The VLAN associated with the IP interface. Only ports in this VLAN will be able to access the IP interface. This field is only available for input when creating a new interface. | |
| | DHCPv4 | Enabled | Enable the DHCPv4 client by checking this box. If this option is enabled, the system will configure the IPv4 address and mask of the interface using the DHCPv4 protocol. The DHCPv4 client will announce the configured System Name as hostname to provide DNS lookup. |
| | | Fallback | The number of seconds for trying to obtain a DHCP lease. After this period expires, a configured IPv4 address will be used as IPv4 interface address. A value of zero disables the fallback mechanism, such that DHCP will keep retrying until a valid lease is obtained. Legal values are 0 to 4294967295 seconds. |
| | | Current Lease | For DHCP interfaces with an active lease, this column show the current interface address, as provided by the DHCP server. |
| IPv4 | Address | The IPv4 address of the interface in dotted decimal notation. If DHCP is enabled, this field configures the fallback address. The field may be left blank if IPv4 operation on the interface is not desired - or no | |

| | | | |
|--------------------|--------------------|----------------------|---|
| | | | DHCP fallback address is desired. |
| | | Mask Length | The IPv4 network mask, in number of bits (prefix length). Valid values are between 0 and 30 bits for a IPv4 address. If DHCP is enabled, this field configures the fallback address network mask. The field may be left blank if IPv4 operation on the interface is not desired - or no DHCP fallback address is desired. |
| | DHCPv6 | Enable | Enable the DHCPv6 client by checking this box. If this option is enabled, the system will configure the IPv6 address of the interface using the DHCPv6 protocol. |
| | | Rapid Commit | Enable the DHCPv6 Rapid-Commit option by checking this box. If this option is enabled, the DHCPv6 client terminates the waiting process as soon as a Reply message with a Rapid Commit option is received. This option is only manageable when DHCPv6 client is enabled. |
| | | Current Lease | For DHCPv6 interface with an active lease, this column shows the interface address provided by the DHCPv6 server. |
| | IPv6 | Address | The IPv6 address of the interface. A IPv6 address is in 128-bit records represented as eight fields of up to four hexadecimal digits with a colon separating each field (:). For example, fe80::215:c5ff:fe03:4dc7. The symbol :: is a special syntax that can be used as a shorthand way of representing multiple 16-bit groups of contiguous zeros; but it can appear only once. System accepts the valid IPv6 unicast address only, except IPv4-Compatible address and IPv4-Mapped address. The field may be left blank if IPv6 operation on the interface is not desired. |
| | | Mask Length | The IPv6 network mask, in number of bits (prefix length). Valid values are between 1 and 128 bits for a IPv6 address. The field may be left blank if IPv6 operation on the interface is not desired. |
| • IP Routes | Delete | | Select this option to delete an existing IP route. |
| | Network | | The destination IP network or host address of this route. Valid format is dotted decimal notation or a valid IPv6 notation. A default route can use the value 0.0.0.0 or IPv6 :: notation. |
| | Mask Length | | The destination IP network or host mask, in number of bits (prefix length). It defines how much of a network address that must match, in order to qualify for this route. Valid values are between 0 and 32 bits respectively 128 for IPv6 routes. Only a default route will have a mask length of 0 (as it will match anything). |
| | Gateway | | The IP address of the IP gateway. Valid format is dotted decimal notation |

| | | |
|--|----------------------|--|
| | | or a valid IPv6 notation. Gateway and Network must be of the same type. |
| | Next Hop VLAN | <p>The VLAN ID (VID) of the specific IPv6 interface associated with the gateway.</p> <p>The given VID ranges from 1 to 4095 and will be effective only when the corresponding IPv6 interface is valid.</p> <p>If the IPv6 gateway address is link-local, it must specify the next hop.</p> |

Buttons

Add Interface: Click to add a new IP interface. A maximum of 128 interfaces are supported.

Add Route: Click to add a new IP route. A maximum of 32 routes are supported.

Apply: Click to apply changes.

Reset: Click to undo any changes made locally and revert to previously saved values.

4.2.1.3 IP Status

IP Status displays the status of the IP protocol layer. The status is defined by the IP interfaces, the IP routes and the neighbor cache (ARP cache) status. The screen in [Figure 4-2-3](#) appears.

IP Interfaces

| Interface | Type | Address | Status |
|-----------|------|-------------------------------|----------------------------------|
| OS:lo | LINK | 00-00-00-00-00-00 | <UP LOOPBACK RUNNING MULTICAST> |
| OS:lo | IPv4 | 127.0.0.1/8 | |
| OS:lo | IPv6 | fe80:1::1/64 | |
| OS:lo | IPv6 | ::1/128 | |
| VLAN1 | LINK | 00-30-4f-11-22-33 | <UP BROADCAST RUNNING MULTICAST> |
| VLAN1 | IPv4 | 192.168.0.100/20 | |
| VLAN1 | IPv6 | fe80:2::230:4fff:fe11:2233/64 | |

IP Routes

| Network | Gateway | Status |
|----------------|-----------|------------|
| 127.0.0.1/32 | 127.0.0.1 | <UP HOST> |
| 192.168.0.0/24 | VLAN1 | <UP HW_RT> |
| 192.168.0.0/20 | VLAN1 | <UP HW_RT> |
| 224.0.0.0/4 | 127.0.0.1 | <UP> |
| ::1/128 | ::1 | <UP HOST> |

Neighbour cache

| IP Address | Link Address |
|----------------------------|-------------------------|
| 192.168.0.123 | VLAN1:00-30-4f-91-e6-45 |
| fe80:2::230:4fff:fe11:2233 | VLAN1:00-30-4f-11-22-33 |

Figure 4-2-3: IP Status Page Screenshot

The page includes the following fields:

| Object | Description | |
|------------------|--------------|--|
| • IP Interfaces | Interface | The name of the interface. |
| | Type | The address type of the entry. This may be LINK or IPv4 . |
| | Address | The current address of the interface (of the given type). |
| | Status | The status flags of the interface (and/or address). |
| • IP Routes | Network | The destination IP network or host address of this route. |
| | Gateway | The gateway address of this route. |
| | Status | The status flags of the route. |
| • Neighbor Cache | IP Address | The IP address of the entry. |
| | Link Address | The Link (MAC) address for which a binding to the IP address given exists. |

Buttons

Auto-refresh : Check this box to refresh the page automatically. Automatic refresh occurs every 3 seconds.

: Click to refresh the page.

4.2.1.4 Users Configuration

This page provides an overview of the current users. Currently the only way to login as another user on the web server is to close and reopen the browser. After setup is completed, press the “**Apply**” button to take effect. Please login web interface with new user name and password; the screen in [Figure 4-2-4](#) appears.

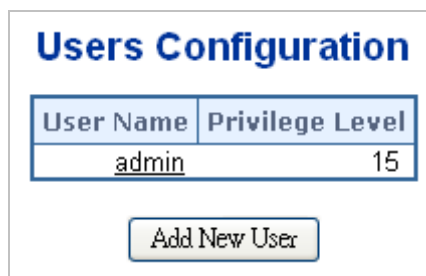

Figure 4-2-4: Users Configuration Page Screenshot

The page includes the following fields:

| Object | Description |
|-------------------|---|
| • User Name | The name identifying the user. This is also a link to Add/Edit User. |
| • Privilege Level | The privilege level of the user. The allowed range is 0 to 15 . If the privilege level value is 15, it can access all groups, i.e. that is granted the full control of the device. But other values need to refer to each group privilege level. User's privilege should be the same or greater than the group privilege level to have the access to that group. |

| | |
|--|---|
| | <p>By default setting, most groups privilege level 5 has the read-only access and privilege level 10 has the read-write access. And the system maintenance (software upload, factory defaults and etc.) needs user privilege level 15.</p> <p>Generally, the privilege level 15 can be used for an administrator account, privilege level 10 for a standard user account and privilege level 5 for a guest account.</p> |
|--|---|

Buttons

: Click to add a new user.

Add / Edit User

This page configures a user – add, edit or delete user.

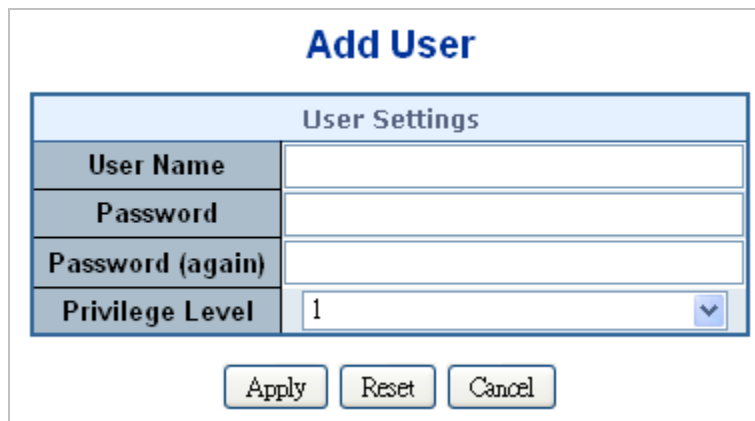





Figure 4-2-5: Add / Edit User Configuration Page Screenshot

The page includes the following fields:

| Object | Description |
|---------------------------|--|
| • Username | A string identifying the user name that this entry should belong to. The allowed string length is 1 to 31 . The valid user name is a combination of letters, numbers and underscores. |
| • Password | The password of the user. The allowed string length is 0 to 31 . |
| • Password (again) | Please enter the user's new password here again to confirm. |
| • Privilege Level | The privilege level of the user. The allowed range is 0 to 15 . If the privilege level value is 15, it can access all groups, i.e. that is granted the fully control of the device. But others value need to refer to each group privilege level. User's privilege should be same or greater than the group privilege level to have the access of that group. |

| | |
|--|---|
| | <p>By default setting, most groups privilege level 5 has the read-only access and privilege level 10 has the read-write access. And the system maintenance (software upload, factory defaults and etc.) needs user privilege level 15.</p> <p>Generally, the privilege level 15 can be used for an administrator account, privilege level 10 for a standard user account and privilege level 5 for a guest account.</p> |
|--|---|

Buttons

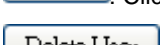
-  : Click to apply changes.
-  : Click to undo any changes made locally and revert to previously saved values.
-  : Click to undo any changes made locally and return to the Users.
-  : Delete the current user. This button is not available for new configurations (Add new user).

Once the new user is added, the new user entry is shown on the Users Configuration page.

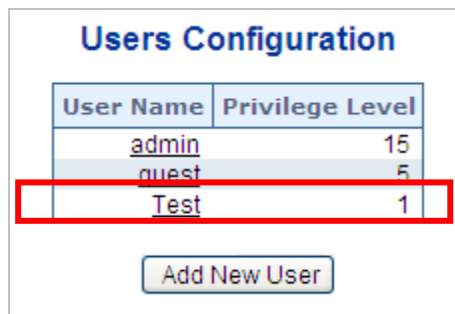

Figure 4-2-6: User Configuration Page Screenshot



If you forget the new password after changing the default password, please press the **“Reset”** button on the front panel of the Industrial Managed Switch for over 10 seconds and then release it. The current setting including VLAN will be lost and the Industrial Managed Switch will restore to the default mode.

4.2.1.5 Privilege Levels

This page provides an overview of the privilege levels. After setup is completed, please press the “Apply” button to take effect. Please login web interface with new user name and password and the screen in [Figure 4-2-7](#) appears.

Privilege Level Configuration

| Group Name | Privilege Levels | | | |
|------------------|-------------------------|----------------------------------|-----------------------------|------------------------------|
| | Configuration Read-only | Configuration/Execute Read/write | Status/Statistics Read-only | Status/Statistics Read/write |
| Aggregation | 5 ▼ | 10 ▼ | 5 ▼ | 10 ▼ |
| Diagnostics | 5 ▼ | 10 ▼ | 5 ▼ | 10 ▼ |
| Firmware | 5 ▼ | 10 ▼ | 5 ▼ | 10 ▼ |
| IP | 5 ▼ | 10 ▼ | 5 ▼ | 10 ▼ |
| IPMC_Snooping | 5 ▼ | 10 ▼ | 5 ▼ | 10 ▼ |
| LACP | 5 ▼ | 10 ▼ | 5 ▼ | 10 ▼ |
| LLDP | 5 ▼ | 10 ▼ | 5 ▼ | 10 ▼ |
| Loop_Protect | 5 ▼ | 10 ▼ | 5 ▼ | 10 ▼ |
| MAC_Table | 5 ▼ | 10 ▼ | 5 ▼ | 10 ▼ |
| Miscellaneous | 15 ▼ | 15 ▼ | 15 ▼ | 15 ▼ |
| MVR | 5 ▼ | 10 ▼ | 5 ▼ | 10 ▼ |
| NTP | 5 ▼ | 10 ▼ | 5 ▼ | 10 ▼ |
| POE | 5 ▼ | 10 ▼ | 5 ▼ | 10 ▼ |
| Ports | 5 ▼ | 10 ▼ | 1 ▼ | 10 ▼ |
| Private_VLANs | 5 ▼ | 10 ▼ | 5 ▼ | 10 ▼ |
| QoS | 5 ▼ | 10 ▼ | 5 ▼ | 10 ▼ |
| Security_access | 10 ▼ | 10 ▼ | 5 ▼ | 10 ▼ |
| Security_network | 5 ▼ | 10 ▼ | 5 ▼ | 10 ▼ |
| Spanning_Tree | 5 ▼ | 10 ▼ | 5 ▼ | 10 ▼ |
| System | 5 ▼ | 10 ▼ | 1 ▼ | 10 ▼ |
| UPnP | 5 ▼ | 10 ▼ | 5 ▼ | 10 ▼ |
| VLANs | 5 ▼ | 10 ▼ | 5 ▼ | 10 ▼ |
| Voice_VLAN | 5 ▼ | 10 ▼ | 5 ▼ | 10 ▼ |

Figure 4-2-7: Privilege Levels Configuration Page Screenshot

The page includes the following fields:

| Object | Description |
|---|---|
| <ul style="list-style-type: none"> • Group Name | <p>The name identifying the privilege group. In most cases, a privilege level group consists of a single module (e.g. LACP, RSTP or QoS), but a few of them contain more than one. The following description defines these privilege level groups in details:</p> |

| | |
|--|--|
| | <ul style="list-style-type: none"> ■ System: Contact, Name, Location, Timezone, Log. ■ Security: Authentication, System Access Management, Port (contains Dot1x port, MAC based and the MAC Address Limit), ACL, HTTPS, SSH, ARP Inspection and IP source guard. ■ IP: Everything except 'ping'. ■ Port: Everything except 'VeriPHY'. ■ Diagnostics: 'ping' and 'VeriPHY'. ■ Maintenance: CLI- System Reboot, System Restore Default, System Password, Configuration Save, Configuration Load and Firmware Load. Web- Users, Privilege Levels and everything in Maintenance. ■ Debug: Only present in CLI. |
| <ul style="list-style-type: none"> • Privilege Level | <p>Every privilege level group has an authorization level for the following sub groups:</p> <ul style="list-style-type: none"> ■ Configuration read-only ■ Configuration/execute read-write ■ Status/statistics read-only ■ Status/statistics read-write (e.g. for clearing of statistics). <p>User Privilege should be same or greater than the authorization Privilege level to have the access to that group.</p> |

Buttons

 : Click to apply changes.

 : Click to undo any changes made locally and revert to previously saved values.

4.2.1.6 NTP Configuration

Configure NTP on this page. **NTP** is an acronym for **Network Time Protocol**, a network protocol for synchronizing the clocks of computer systems. NTP uses UDP (data grams) as transport layer. You can specify NTP Servers. The NTP Configuration screen in [Figure 4-2-8](#) appears.

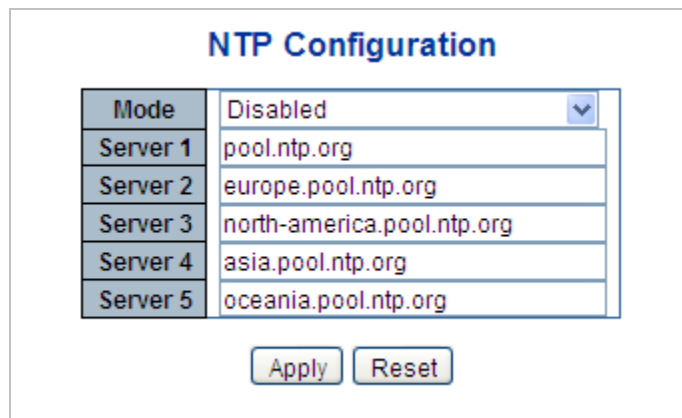



Figure 4-2-8: NTP Configuration Page Screenshot

The page includes the following fields:

| Object | Description |
|---|---|
| <ul style="list-style-type: none"> • Mode | <p>Indicates the NTP mode operation. Possible modes are:</p> <ul style="list-style-type: none"> ■ Enabled: Enable NTP mode operation. When enabling NTP mode operation, the agent forward and transfer NTP messages between the clients and the server when they are not on the same subnet domain. ■ Disabled: Disable NTP mode operation. |
| <ul style="list-style-type: none"> • Server # | <p>Provide the NTP IPv4 or IPv6 address of this switch. IPv6 address is in 128-bit records represented as eight fields of up to four hexadecimal digits with a colon separating each field (:).</p> <p>For example, 'fe80::215:c5ff:fe03:4dc7'. The symbol '::' is a special syntax that can be used as a shorthand way of representing multiple 16-bit groups of contiguous zeros, but it can only appear once. It also uses a legal IPv4 address like '::192.1.2.34'.</p> |

Buttons

 : Click to apply changes.

 : Click to undo any changes made locally and revert to previously saved values.

4.2.1.6.1 System Time Correction Manually

Configure NTP on this page. **NTP** is an acronym for **Network Time Protocol**, a network protocol for synchronizing the clocks of computer systems. NTP uses UDP (data grams) as transport layer. You can specify NTP Servers. The NTP Configuration screen in [Figure 4-2-9](#) appears.

System Time Correction Manually

| | | |
|----------------------|---------------------------------|---------------|
| User Manually | <input type="checkbox"/> Enable | |
| Year | 1970 | (1970 ~ 2037) |
| Month | 1 | (1 ~ 12) |
| Day | 1 | (1 ~ 31) |
| Hour | 0 | (0 ~ 23) |
| Minute | 0 | (0 ~ 59) |
| Second | 0 | (0 ~ 59) |

Figure 4-2-9: System time correction Manually Page Screenshot

The page includes the following fields:

| Object | Description |
|--|---|
| <ul style="list-style-type: none"> • User Manually | Indicates the NTP mode as manual operation. Possible modes are: <ul style="list-style-type: none"> ■ Enabled: Enable NTP manual mode operation. When enabling NTP user manually mode operation, the system time will follow the date setting. ■ Disabled: Disable NTP user manual mode operation. |
| <ul style="list-style-type: none"> • Date | If enable the user manually , Switch can set the Year / Mouth / Day/ Hour / Minute / Second in this page |

Buttons

: Click to apply changes.

: Click to undo any changes made locally and revert to previously saved values.

4.2.1.7 Time Configuration

Configure Time Zone on this page. A **Time Zone** is a region that has a uniform standard time for legal, commercial, and social purposes. It is convenient for areas in close commercial or other communication to keep the same time, so time zones tend to follow the boundaries of countries and their subdivisions. The Time Zone Configuration screen in Figure 4-2-10 appears

System Log Information

Auto-refresh Refresh Clear Hide Download |<< << >> >>|

| | |
|-------------|-------|
| Level | All ▼ |
| Clear Level | All ▼ |

The total number of entries is 5 for the given level.

Start from ID with entries per page.

| ID | Level | Time | Message |
|----|---------------|-------------------------------|--|
| 1 | Informational | 1970-01-01 Thu 00:00:57+00:00 | SYS-BOOTING: Switch just made a cold boot. |
| 2 | Informational | 1970-01-01 Thu 00:01:00+00:00 | DC1 Power OFF |
| 3 | Informational | 1970-01-01 Thu 00:01:06+00:00 | LINK-UPDOWN: Interface GigabitEthernet 1/1, changed state to up. |
| 4 | Informational | 1970-01-01 Thu 00:20:35+00:00 | LINK-UPDOWN: Interface GigabitEthernet 1/1, changed state to down. |
| 5 | Informational | 1970-01-01 Thu 00:38:13+00:00 | LINK-UPDOWN: Interface GigabitEthernet 1/1, changed state to up. |

Figure 4-2-10: Time Configuration Page Screenshot

The page includes the following fields:

| Object | Description |
|---|--|
| <ul style="list-style-type: none"> Time Zone | Lists various Time Zones worldwide. Select appropriate Time Zone from the drop-down and click Save to set. |
| <ul style="list-style-type: none"> Acronym | User can set the acronym of the time zone. This is a User configurable acronym to identify the time zone. (Range: Up to 16 characters) |
| <ul style="list-style-type: none"> Daylight Saving Time | This is used to set the clock forward or backward according to the configurations set below for a defined Daylight Saving Time duration. Select 'Disable' to disable the Daylight Saving Time configuration. Select 'Recurring' and configure the Daylight Saving Time duration to repeat the configuration every year. Select 'Non-Recurring' and configure the Daylight Saving Time duration for single time configuration. (Default: Disabled). |
| <ul style="list-style-type: none"> Start Time Settings | <ul style="list-style-type: none"> Week - Select the starting week number. Day - Select the starting day. Month - Select the starting month. Hours - Select the starting hour. Minutes - Select the starting minute. |
| <ul style="list-style-type: none"> End Time Settings | <ul style="list-style-type: none"> Week - Select the ending week number. Day - Select the ending day. Month - Select the ending month. Hours - Select the ending hour. Minutes - Select the ending minute |

| | |
|--|--|
| <ul style="list-style-type: none"> • Offset Settings | Enter the number of minutes to add during Daylight Saving Time. (Range: 1 to 1440) |
|--|--|

Buttons

: Click to apply changes.

: Click to undo any changes made locally and revert to previously saved values.

4.2.1.8 UPnP

Configure UPnP on this page. UPnP is an acronym for **Universal Plug and Play**. The goals of UPnP are to allow devices to connect seamlessly and to simplify the implementation of networks in the home (data sharing, communications, and entertainment) and in corporate environments for simplified installation of computer components. The UPnP Configuration screen in [Figure 4-2-11](#) appears.

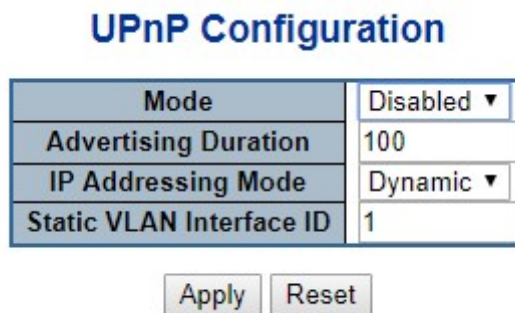

Figure 4-2-11: UPnP Configuration Page Screenshot

The page includes the following fields:

| Object | Description |
|---|---|
| <ul style="list-style-type: none"> • Mode | <p>Indicates the UPnP operation mode. Possible modes are:</p> <ul style="list-style-type: none"> ■ Enabled: Enable UPnP mode operation. ■ Disabled: Disable UPnP mode operation. <p>When the mode is enabled, two ACEs are added automatically to trap UPnP related packets to CPU. The ACEs are automatically removed when the mode is disabled.</p> |
| <ul style="list-style-type: none"> • Advertising Duration | <p>The duration, carried in SSDP packets, is used to inform a control point or control points how often it or they should receive a SSDP advertisement message from this switch. If a control point does not receive any message within the duration, it will think that the switch no longer exists. Due to the unreliable nature of UDP, in the standard it is recommended that such refreshing of advertisements to be</p> |

| | |
|---|--|
| | done at less than one-half of the advertising duration. In the implementation, the switch sends SSDP messages periodically at the interval one-half of the advertising duration minus 30 seconds. Valid values are in the range 100 to 86400. |
| <ul style="list-style-type: none"> • IP Addressing Mode | IP addressing mode provides two ways to determine IP address assignment: Dynamic : Default selection for UPnP. UPnP module helps users choosing the IP address of the switch device. It finds the first available system IP address. Static : User specifies the IP interface VLAN for choosing the IP address of the switch device. |
| <ul style="list-style-type: none"> • Static VLAN Interface ID | The index of the specific IP VLAN interface. It will only be applied when IP Addressing Mode is static. Valid configurable values ranges from 1 to 4095. Default value is 1. |

Buttons



: Click to apply changes



: Click to undo any changes made locally and revert to previously saved values.

4.2.1.9 DHCP Relay

Configure DHCP Relay on this page. **DHCP Relay** is used to forward and transfer DHCP messages between the clients and the server when they are not on the same subnet domain.

The **DHCP option 82** enables a DHCP relay agent to insert specific information into a DHCP request packets when forwarding client DHCP packets to a DHCP server and remove the specific information from a DHCP reply packets when forwarding server DHCP packets to a DHCP client. The DHCP server can use this information to implement IP address or other assignment policies. Specifically the option works by setting two sub-options:

- **Circuit ID (option 1)**
- **Remote ID (option 2)**

The **Circuit ID** sub-option is supposed to include information specific to which circuit the request came in on.

The **Remote ID** sub-option was designed to carry information relating to the remote host end of the circuit.

The definition of Circuit ID in the switch is 4 bytes in length and the format is "vlan_id" "module_id" "port_no". The parameter of "vlan_id" is the first two bytes representing the VLAN ID. The parameter of "module_id" is the third byte for the module ID. The parameter of "port_no" is the fourth byte and it means the port number.

The Remote ID is 6 bytes in length, and the value equals the DHCP relay agent's MAC address. The DHCP Relay Configuration screen in [Figure 4-2-12](#) appears.

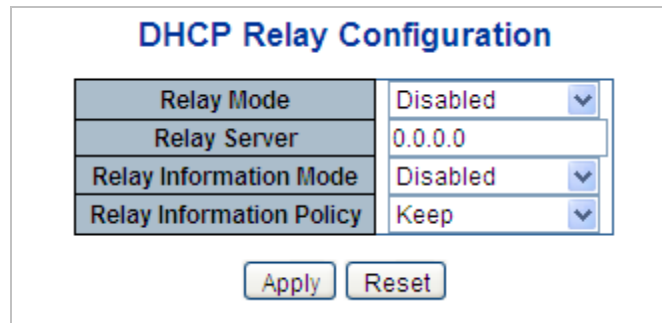

Figure 4-2-12 DHCP Relay Configuration Page Screenshot

The page includes the following fields:

| Object | Description |
|---|--|
| <ul style="list-style-type: none"> • Relay Mode | <p>Indicates the DHCP relay mode operation. Possible modes are:</p> <ul style="list-style-type: none"> ■ Enabled: Enable DHCP relay mode operation. When enabling DHCP relay mode operation, the agent forwards and transfers DHCP messages between the clients and the server when they are not on the same subnet domain. And the DHCP broadcast message won't flood for security considered. ■ Disabled: Disable DHCP relay mode operation. |
| <ul style="list-style-type: none"> • Relay Server | <p>Indicates the DHCP relay server IP address. A DHCP relay agent is used to forward and transfer DHCP messages between the clients and the server when they are not on the same subnet domain.</p> |
| <ul style="list-style-type: none"> • Relay Information Mode | <p>Indicates the DHCP relay information mode option operation. Possible modes are:</p> <ul style="list-style-type: none"> ■ Enabled: Enable DHCP relay information mode operation. When enabling DHCP relay information mode operation, the agent inserts specific information (option82) into a DHCP message when forwarding to DHCP server and removing it from a DHCP message when transferring to DHCP client. It only works under DHCP relay operation mode enabled. ■ Disabled: Disable DHCP relay information mode operation. |
| <ul style="list-style-type: none"> • Relay Information Policy | <p>Indicates the DHCP relay information option policy. When enabling DHCP relay information mode operation, if agent receives a DHCP message that already contains relay agent information. It will enforce the policy. And it only works under DHCP relay information operation mode enabled. Possible policies are:</p> <ul style="list-style-type: none"> ■ Replace: Replace the original relay information when receiving a DHCP message that already contains it. ■ Keep: Keep the original relay information when receiving a DHCP message that already contains it. ■ Drop: Drop the package when receiving a DHCP message that already contains relay information. |

Buttons

Apply : Click to apply changes

Reset : Click to undo any changes made locally and revert to previously saved values.

4.2.1.10 DHCP Relay Statistics

This page provides statistics for DHCP relay. The DHCP Relay Statistics screen in [Figure 4-2-13](#) appears.

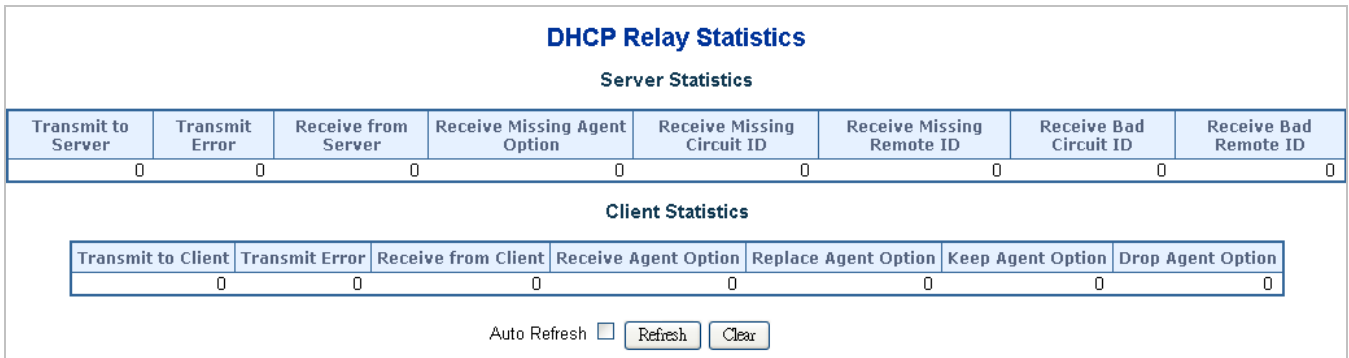

Figure 4-2-13: DHCP Relay Statistics Page Screenshot

The page includes the following fields:

Server Statistics

| Object | Description |
|---------------------------------------|---|
| • Transmit to Server | The packets number that relayed from client to server. |
| • Transmit Error | The packets number that erroneously sent packets to clients. |
| • Receive from Server | The packets number that received packets from server. |
| • Receive Missing Agent Option | The packets number that received packets without agent information options. |
| • Receive Missing Circuit ID | The packets number that received packets whose the Circuit ID option was missing. |
| • Receive Missing Remote ID | The packets number that received packets whose Remote ID option was missing. |
| • Receive Bad Circuit ID | The packets number whose the Circuit ID option did not match known circuit ID. |
| Receive Bad Remote ID | The packets number whose the Remote ID option did not match known Remote ID. |

Client Statistics

| Object | Description |
|-------------------------------|--|
| • Transmit to Client | The packets number that relayed packets from server to client. |
| • Transmit Error | The packets number that erroneously sent packets to servers. |
| • Receive from Client | The packets number that received packets from server. |
| • Receive Agent Option | The packets number that received packets with relay agent information option. |
| • Replace Agent Option | The packets number that replaced received packets with relay agent information option. |
| • Keep Agent Option | The packets number that kept received packets with relay agent information option. |
| • Drop Agent Option | The packets number that dropped received packets with relay agent information option. |

Buttons

Auto-refresh : Check this box to refresh the page automatically. Automatic refresh occurs every 3 seconds.

: Click to refresh the page immediately.

: Clears all statistics.

4.2.1.11 CPU Load

This page displays the CPU load, using an SVG graph. The load is measured as average over the last 100ms, 1 sec and 10 seconds intervals. The last 120 samples are graphed, and the last numbers are displayed as text as well. In order to display the SVG graph, your browser must support the SVG format. Consult the SVG Wiki for more information on browser support. Specifically, at the time of writing, Microsoft Internet Explorer will need to have a plugin installed to support SVG. The CPU Load screen in [Figure 4-2-14](#) appears.

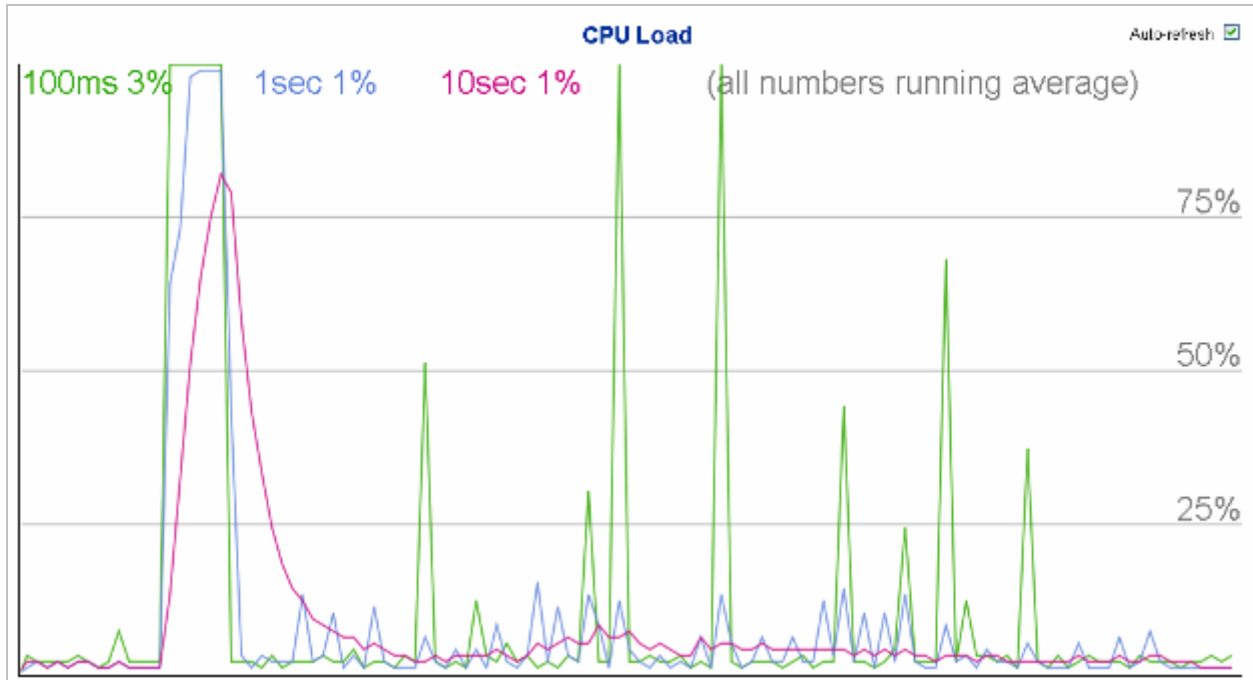

Figure 4-2-14: CPU Load Page Screenshot

Buttons

Auto-refresh : Check this box to refresh the page automatically. Automatic refresh occurs every 3 seconds.



If your browser cannot display anything on this page, please download Adobe SVG tool and install it in your computer.

4.2.1.12 System Log

The **Industrial Managed Switch** system log information is provided here. The System Log screen in [Figure 4-2-15](#) appears.

System Log Information

Auto-refresh Refresh Clear Hide Download |<< << >> >>|

| | |
|-------------|-------|
| Level | All ▼ |
| Clear Level | All ▼ |

The total number of entries is 5 for the given level.

Start from ID with entries per page.

| ID | Level | Time | Message |
|----|---------------|-------------------------------|--|
| 1 | Informational | 1970-01-01 Thu 00:00:57+00:00 | SYS-BOOTING: Switch just made a cold boot. |
| 2 | Informational | 1970-01-01 Thu 00:01:00+00:00 | DC1 Power OFF |
| 3 | Informational | 1970-01-01 Thu 00:01:06+00:00 | LINK-UPDOWN: Interface GigabitEthernet 1/1, changed state to up. |
| 4 | Informational | 1970-01-01 Thu 00:20:35+00:00 | LINK-UPDOWN: Interface GigabitEthernet 1/1, changed state to down. |
| 5 | Informational | 1970-01-01 Thu 00:38:13+00:00 | LINK-UPDOWN: Interface GigabitEthernet 1/1, changed state to up. |

Figure 4-2-15: System Log Page Screenshot

The page includes the following fields:

| Object | Description |
|---------------|--|
| • ID | The ID (>= 1) of the system log entry. |
| • Level | The level of the system log entry. The following level types are supported: <ul style="list-style-type: none"> ■ Info: Information level of the system log. ■ Warning: Warning level of the system log. ■ Error: Error level of the system log. ■ All: All levels. |
| • Clear Level | To clear the system log entry level. The following level types are supported: <ul style="list-style-type: none"> ■ Info: Information level of the system log. ■ Warning: Warning level of the system log. ■ Error: Error level of the system log. ■ All: All levels. |
| • Time | The time of the system log entry. |
| • Message | The message of the system log entry. |

Buttons

Auto-refresh : Check this box to refresh the page automatically. Automatic refresh occurs every 3 seconds.

Refresh : Updates the system log entries, starting from the current entry ID.

Clear : Flushes the selected log entries.

Hide : Hides the selected log entries.

Download : Downloads the selected log entries.

<< : Updates the system log entries, starting from the first available entry ID.

: Updates the system log entries, ending at the last entry currently displayed.

: Updates the system log entries, starting from the last entry currently displayed.

: Updates the system log entries, ending at the last available entry ID.

4.2.1.13 Detailed Log

The **Industrial Managed Switch** system detailed log information is provided here. The Detailed Log screen in [Figure 4-2-16](#) appears.

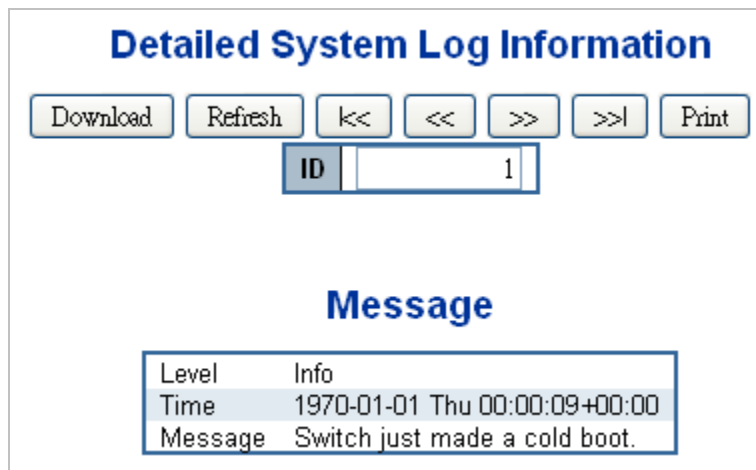



Figure 4-2-16: Detailed Log Page Screenshot

The page includes the following fields:

| Object | Description |
|-----------|--|
| • ID | The ID (≥ 1) of the system log entry. |
| • Message | The message of the system log entry. |

Buttons

: Download the system log entry to the current entry ID.

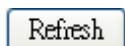
: Updates the system log entry to the current entry ID.

: Updates the system log entry to the first available entry ID.

: Updates the system log entry to the previous available entry ID.

: Updates the system log entry to the next available entry ID.

: Updates the system log entry to the last available entry ID.

: Print the system log entry to the current entry ID.

4.2.1.14 Remote Syslog

Configure remote syslog on this page. The Remote Syslog screen in [Figure 4-2-17](#) appears.

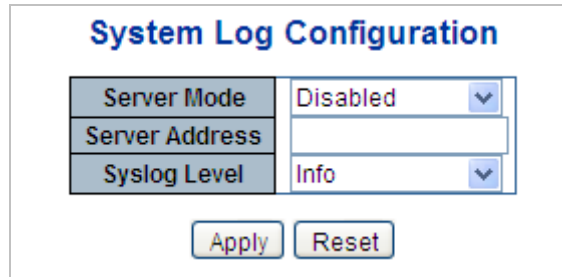



Figure 4-2-17: Remote Syslog Page Screenshot

The page includes the following fields:

| Object | Description |
|---|---|
| <ul style="list-style-type: none"> • Mode | <p>Indicates the server mode operation. When the mode operation is enabled, the syslog message will send out to syslog server. The syslog protocol is based on UDP communication and received on UDP port 514 and the syslog server will not send acknowledgments back sender since UDP is a connectionless protocol and it does not provide acknowledgments. The syslog packet will always send out even if the syslog server does not exist. Possible modes are:</p> <ul style="list-style-type: none"> ■ Enabled: Enable remote syslog mode operation. ■ Disabled: Disable remote syslog mode operation. |
| <ul style="list-style-type: none"> • Syslog Server IP | <p>Indicates the IPv4 host address of syslog server. If the switch provides DNS feature, it also can be a host name.</p> |
| <ul style="list-style-type: none"> • Syslog Level | <p>Indicates what kind of message will send to syslog server. Possible modes are:</p> <ul style="list-style-type: none"> ■ Info: Send information, warnings and errors. ■ Warning: Send warnings and errors. ■ Error: Send errors. |

Buttons

 : Click to apply changes

 : Click to undo any changes made locally and revert to previously saved values.

4.2.1.15 SMTP Configuration

This page facilitates an SMTP Configuration on the switch. The SMTP Configure screen in [Figure 4-2-18](#) appears.

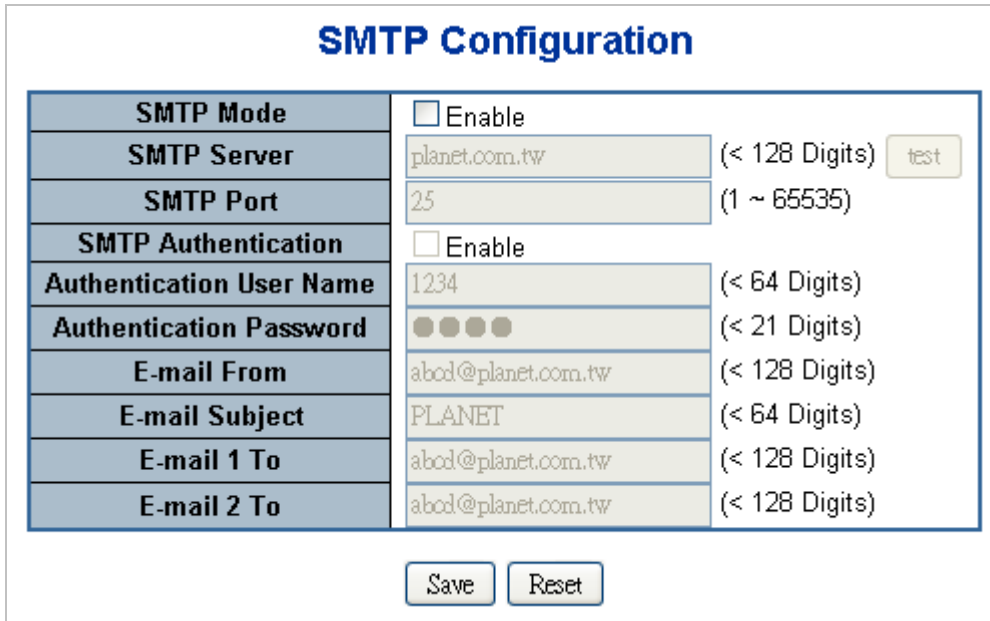

| SMTP Configuration | |
|---------------------------------|--|
| SMTP Mode | <input type="checkbox"/> Enable |
| SMTP Server | planet.com.tw (< 128 Digits) <input type="button" value="test"/> |
| SMTP Port | 25 (1 ~ 65535) |
| SMTP Authentication | <input type="checkbox"/> Enable |
| Authentication User Name | 1234 (< 64 Digits) |
| Authentication Password | ●●●● (< 21 Digits) |
| E-mail From | abod@planet.com.tw (< 128 Digits) |
| E-mail Subject | PLANET (< 64 Digits) |
| E-mail 1 To | abod@planet.com.tw (< 128 Digits) |
| E-mail 2 To | abod@planet.com.tw (< 128 Digits) |

Figure 4-2-18: SMTP Configuration Page Screenshot

The page includes the following fields:

| Object | Description |
|-----------------------------------|---|
| • SMTP Mode | Controls whether SMTP is enabled on this switch. |
| • SMTP Server | Type the SMTP server name or the IP address of the SMTP server. |
| • SMTP Port | Set port number of SMTP service. |
| • SMTP Authentication | Controls whether SMTP authentication is enabled if authentication is required when an e-mail is sent. |
| • Authentication User Name | Type the user name for the SMTP server if Authentication is Enabled. |
| • Authentication Password | Type the password for the SMTP server if Authentication is Enabled. |
| • E-mail From | Type the sender's e-mail address. This address is used for reply e-mails. |
| • E-mail Subject | Type the subject/title of the e-mail. |
| • E-mail 1 To | Type the receiver's e-mail address. |
| • E-mail 2 To | |

Buttons

: Send a test mail to mail server to check whether this account is available or not.

: Click to save changes.

: Click to undo any changes made locally and revert to previously saved values.

4.2.1.16 Fault Alarm

This page facilitates an update of the firmware controlling the switch. The Web Firmware Upgrade screen in [Figure 4-2-19](#) appears.

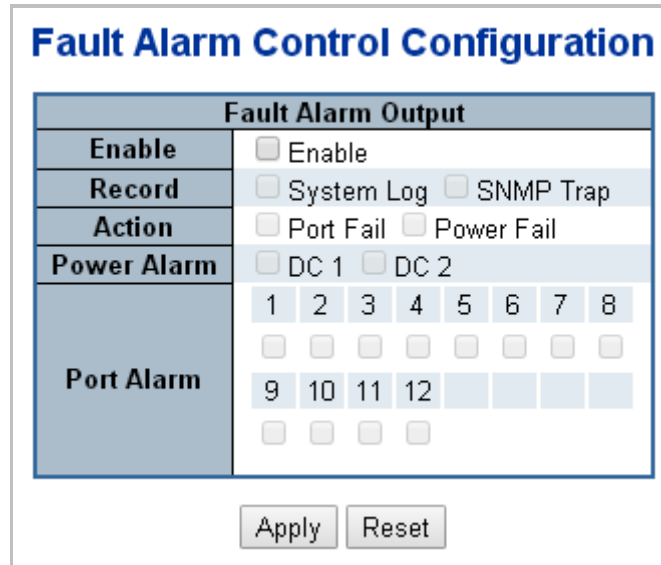



Figure 4-2-19: Fault Alarm Control Configuration page Screenshot

The page includes the following fields:

| Object | Description |
|----------------------|---|
| • Enable | Controls whether Fault Alarm is enabled on this switch. |
| • Record | Controls whether Record is sending System log or SNMP Trap or both. |
| • Action | Controls whether Port Fail or Power Fail or both for fault detecting. |
| • Power Alarm | Controls whether AC, DC1 or DC2 or both for fault detecting. |
| • Port Alarm | Controls which Ports or all for fault detecting. |

Buttons

: Click to apply changes

: Click to undo any changes made locally and revert to previously saved values.

4.2.1.17 Digital Input/Output

Digital Input allows user to log external device (such as industrial cooler) dead or alive or something else. System will log a user customized message into system log and syslog, and issue SNMP trap or issue an alarm E-mail.

Digital Output allows user to monitor the switch port and power, and let system issue a high or low signal to an external device (such as alarm) when the monitor port or power has failed. The Configuration screen in [Figure 4-2-20](#) appears.

Digital Input/Output Control Configuration

| Digital Input 0 | | Digital Input 1 | |
|--------------------------|--|--------------------------|--|
| Enable | <input type="checkbox"/> Enable | Enable | <input type="checkbox"/> Enable |
| Condition | High to Low ▾ | Condition | High to Low ▾ |
| Event Description | Customize DIO Message. | Event Description | Customize DI1 Message. |
| Event | <input type="checkbox"/> System Log <input type="checkbox"/> SNMP Trap | Event | <input type="checkbox"/> System Log <input type="checkbox"/> SNMP Trap |

| Digital Output 0 | | Digital Output 1 | |
|------------------------|--|------------------------|--|
| Enable | <input type="checkbox"/> Enable | Enable | <input type="checkbox"/> Enable |
| Event | <input type="checkbox"/> Power Fail <input type="checkbox"/> Port Fail <input type="checkbox"/> DI 0 <input type="checkbox"/> DI 1 | Event | <input type="checkbox"/> Power Fail <input type="checkbox"/> Port Fail <input type="checkbox"/> DI 0 <input type="checkbox"/> DI 1 |
| Condition | High to Low ▾ | Condition | High to Low ▾ |
| Power Alarm | <input type="checkbox"/> DC 1 <input type="checkbox"/> DC 2 | Power Alarm | <input type="checkbox"/> DC 1 <input type="checkbox"/> DC 2 |
| Port Fail Alarm | 1 2 3 4 5 6 7 8 <input type="checkbox"/> <input type="checkbox"/> <input type="checkbox"/> <input type="checkbox"/> <input type="checkbox"/> <input type="checkbox"/> <input type="checkbox"/> <input type="checkbox"/> | Port Fail Alarm | 1 2 3 4 5 6 7 8 <input type="checkbox"/> <input type="checkbox"/> <input type="checkbox"/> <input type="checkbox"/> <input type="checkbox"/> <input type="checkbox"/> <input type="checkbox"/> <input type="checkbox"/> |
| | 9 10 11 12 <input type="checkbox"/> <input type="checkbox"/> <input type="checkbox"/> | | 9 10 11 12 <input type="checkbox"/> <input type="checkbox"/> <input type="checkbox"/> |
| | <input type="checkbox"/> <input type="checkbox"/> <input type="checkbox"/> <input type="checkbox"/> | | <input type="checkbox"/> <input type="checkbox"/> <input type="checkbox"/> <input type="checkbox"/> |

Figure 4-2-20 Digital Input/Output Control Configuration page Screenshot

The page includes the following fields:

| Object | Description |
|--|--|
| <ul style="list-style-type: none"> Enable | Check the Enable checkbox to enable Digital Input / output function. Uncheck the Enable checkbox to disable Digital input / output function. |
| <ul style="list-style-type: none"> Condition | <p>As Digital Input:</p> <p>Allows user to select High to Low or Low to High. This means a signal received by system is from High to Low or From Low to High. It will trigger an action that logs a customize message or issue the message from the switch.</p> <p>As Digital Output:</p> <p>Allows user to select High to Low or Low to High. This means that when the switch is power-failed or port-failed, then system will issue a High or Low signal to an external device such as an alarm.</p> |
| <ul style="list-style-type: none"> Event Description | Allows user to set a customized message for Digital Input function alarming. |
| <ul style="list-style-type: none"> Event | <p>As Digital Input:</p> |

| | |
|--|--|
| | <p>Allows user to record alarm message to System log, syslog or issues out via SNMP Trap or SMTP.</p> <p>As default SNMP Trap and SMTP are disabled, please enable them first if you want to issue alarm message via them.</p> <p>As Digital Output:</p> <p>Allows user to monitor an alarm from port failure, power failure, Digital Input 0 (DI 0) and Digital Input 1(DI 1) which means if Digital Output has detected these events, then Digital Output would be triggered according to the setting of Condition.</p> |
| <ul style="list-style-type: none"> • Power Alarm | <p>Allows user to choose which power module that needs to be monitored.</p> |
| <ul style="list-style-type: none"> • Port Alarm | <p>Allows user to choose which port that needs to be monitored.</p> |

Buttons

 : Click to save changes.

 : Click to undo any changes made locally and revert to previously saved values.

4.2.2 Simple Network Management Protocol

4.2.2.1 SNMP Overview

The Simple Network Management Protocol (SNMP) is an application layer protocol that facilitates the exchange of management information between network devices. It is part of the Transmission Control Protocol/Internet Protocol (TCP/IP) protocol suite. SNMP enables network administrators to manage network performance, find and solve network problems, and plan for network growth.

An SNMP-managed network consists of three key components: Network management stations (NMSs), SNMP agents, Management information base (MIB) and network-management protocol:

- **Network management stations (NMSs):** Sometimes called consoles, these devices execute management applications that monitor and control network elements. Physically, NMSs are usually engineering workstation-caliber computers with fast CPUs, megapixel color displays, substantial memory, and abundant disk space. At least one NMS must be present in each managed environment.
- **Agents:** Agents are software modules that reside in network elements. They collect and store management information such as the number of error packets received by a network element.
- **Management information base (MIB):** A MIB is a collection of managed objects residing in a virtual information store. Collections of related managed objects are defined in specific MIB modules.
- **Network-management protocol:** A management protocol is used to convey management information between agents and NMSs. SNMP is the Internet community's de facto standard management protocol.

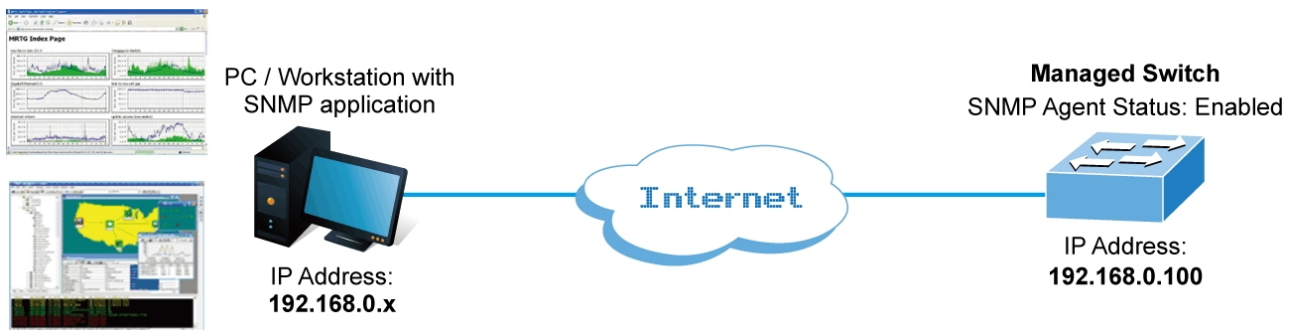

Figure 4-2-2-1:

SNMP Operations

SNMP itself is a simple request/response protocol. NMSs can send multiple requests without receiving a response.

- **Get** -- Allows the NMS to retrieve an object instance from the agent.
- **Set** -- Allows the NMS to set values for object instances within an agent.
- **Trap** -- Used by the agent to asynchronously inform the NMS of some event. The SNMPv2 trap message is designed to replace the SNMPv1 trap message.

SNMP community

An SNMP community is the group that devices and management stations running SNMP belong to. It helps define where information is sent. The community name is used to identify the group. An SNMP device or agent may belong to more than one SNMP community. It will not respond to requests from management stations that do not belong to one of its communities. SNMP

default communities are:

- **Write** = private
- **Read** = public

Use the SNMP Menu to display or configure the **Industrial Managed Switch** 's SNMP function. This section has the following items:

- **System Configuration** Configure SNMP on this page.
- **Trap Configuration** Configure SNMP trap on this page.
- **System Information** The system information is provided here.
- **SNMPv3 Communities** Configure SNMPv3 communities table on this page.
- **SNMPv3 Users** Configure SNMPv3 users table on this page.
- **SNMPv3 Groups** Configure SNMPv3 groups table on this page.
- **SNMPv3 Views** Configure SNMPv3 views table on this page.
- **SNMPv3 Access** Configure SNMPv3 accesses table on this page.

4.2.2.2 SNMP System Configuration

Configure SNMP on this page. The SNMP System Configuration screen in [Figure 4-2-2-2](#) appears.

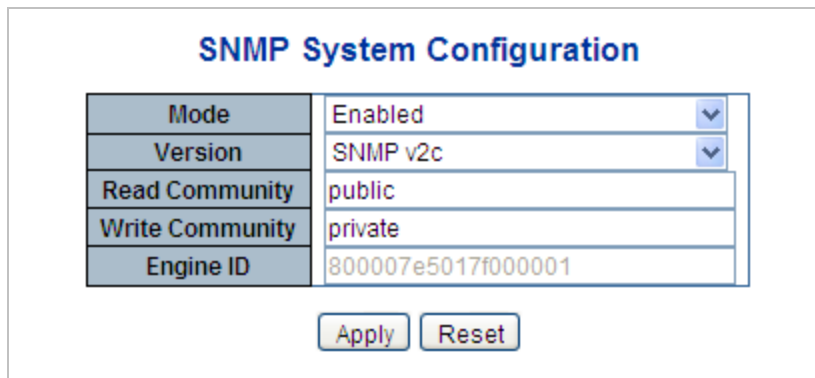



Figure 4-2-2-2: SNMP System Configuration Page Screenshot

The page includes the following fields:

| Object | Description |
|--|--|
| <ul style="list-style-type: none"> • Mode | Indicates the SNMP mode operation. Possible modes are: <ul style="list-style-type: none"> ■ Enabled: Enable SNMP mode operation. ■ Disabled: Disable SNMP mode operation. |
| <ul style="list-style-type: none"> • Version | Indicates the SNMP supported version. Possible versions are: <ul style="list-style-type: none"> ■ SNMP v1: Set SNMP supported version 1. ■ SNMP v2c: Set SNMP supported version 2c. ■ SNMP v3: Set SNMP supported version 3. |

| | |
|--|---|
| <ul style="list-style-type: none"> • Read Community | <p>Indicates the community read access string to permit access to SNMP agent. The allowed string length is 0 to 255, and the allowed content is the ASCII characters from 33 to 126.</p> <p>The field is applicable only when SNMP version is SNMPv1 or SNMPv2c. If SNMP version is SNMPv3, the community string will be associated with SNMPv3 communities table. It provides more flexibility to configure security name than a SNMPv1 or SNMPv2c community string. In addition to community string, a particular range of source addresses can be used to restrict source subnet.</p> |
| <ul style="list-style-type: none"> • Write Community | <p>Indicates the community write access string to permit access to SNMP agent. The allowed string length is 0 to 255, and the allowed content is the ASCII characters from 33 to 126.</p> <p>The field is applicable only when SNMP version is SNMPv1 or SNMPv2c. If SNMP version is SNMPv3, the community string will be associated with SNMPv3 communities table. It provides more flexibility to configure security name than a SNMPv1 or SNMPv2c community string. In addition to community string, a particular range of source addresses can be used to restrict source subnet.</p> |
| <ul style="list-style-type: none"> • Engine ID | <p>Indicates the SNMPv3 engine ID. The string must contain an even number between 10 and 64 hexadecimal digits, but all-zeros and all-'F's are not allowed. Change of the Engine ID will clear all original local users.</p> |

Buttons

 : Click to apply changes

 : Click to undo any changes made locally and revert to previously saved values.

4.2.2.3 SNMP Trap Configuration

Configure SNMP trap on this page. The SNMP Trap Configuration screen in [Figure 4-2-2-3](#) appears.

SNMP Trap Configuration

| | |
|--------------------------------------|------------------------|
| Trap Config Name | <input type="text"/> |
| Trap Mode | Disabled ▼ |
| Trap Version | SNMP v2c ▼ |
| Trap Community | public |
| Trap Destination Address | <input type="text"/> |
| Trap Destination Port | 162 |
| Trap Inform Mode | Disabled ▼ |
| Trap Inform Timeout (seconds) | 3 |
| Trap Inform Retry Times | 5 |
| Trap Security Engine ID | 800028d80300304f112274 |
| Trap Security Name | None ▼ |

Figure 4-2-2-3: SNMP Trap Configuration Page Screenshot

The page includes the following fields:

| Object | Description |
|-----------------------------------|--|
| • Trap Config | Indicates which trap Configuration's name for configuring. The allowed string length is 0 to 255, and the allowed content is ASCII characters from 33 to 126. |
| • Trap Mode | Indicates the SNMP trap mode operation. Possible modes are: <ul style="list-style-type: none"> ■ Enabled: Enable SNMP trap mode operation. ■ Disabled: Disable SNMP trap mode operation. |
| • Trap Version | Indicates the SNMP trap supported version. Possible versions are: <ul style="list-style-type: none"> ■ SNMP v1: Set SNMP trap supported version 1. ■ SNMP v2c: Set SNMP trap supported version 2c. ■ SNMP v3: Set SNMP trap supported version 3. |
| • Trap Community | Indicates the community access string when send SNMP trap packet. The allowed string length is 0 to 255, and the allowed content is the ASCII characters from 33 to 126. |
| • Trap Destination Address | Indicates the SNMP trap destination address. |
| • Trap Destination Port | Indicates the SNMP trap destination port. SNMP Agent will send SNMP message via this port, the port range is 1~65535. |

| | |
|--|---|
| <ul style="list-style-type: none"> • Trap Inform Mode | <p>Indicates the SNMP trap inform mode operation. Possible modes are:</p> <ul style="list-style-type: none"> ■ Enabled: Enable SNMP trap authentication failure. ■ Disabled: Disable SNMP trap authentication failure. |
| <ul style="list-style-type: none"> • Trap Inform Timeout (seconds) | <p>Indicates the SNMP trap inform timeout.</p> <p>The allowed range is 0 to 2147.</p> |
| <ul style="list-style-type: none"> • Trap Inform Retry Times | <p>Indicates the SNMP trap inform retry times.</p> <p>The allowed range is 0 to 255.</p> |
| <ul style="list-style-type: none"> • Trap Probe Security Engine ID | <p>Indicates the SNMPv3 trap probe security engine ID mode of operation. Possible values are:</p> <ul style="list-style-type: none"> ■ Enabled: Enable SNMP trap probe security engine ID mode of operation. ■ Disabled: Disable SNMP trap probe security engine ID mode of operation. |
| <ul style="list-style-type: none"> • Trap Security Engine ID | <p>Indicates the SNMP trap security engine ID. SNMPv3 sends traps and informs using USM for authentication and privacy. A unique engine ID for these traps and informs is needed. When "Trap Probe Security Engine ID" is enabled, the ID will be probed automatically. Otherwise, the ID specified in this field is used. The string must contain an even number(in hexadecimal format) with number of digits between 10 and 64, but all-zeros and all-'F's are not allowed.</p> |
| <ul style="list-style-type: none"> • Trap Security Name | <p>Indicates the SNMP trap security name. SNMPv3 traps and informs using USM for authentication and privacy. A unique security name is needed when traps and informs are enabled.</p> |
| <ul style="list-style-type: none"> • System | <p>Enable/disable that the Interface group's traps. Possible traps are:</p> <ul style="list-style-type: none"> ■ Warm Start: Enable/disable Warm Start trap. ■ Cold Start: Enable/disable Cold Start trap. |
| <ul style="list-style-type: none"> • Interface | <p>Indicates that the Interface group's traps. Possible traps are:</p> <ul style="list-style-type: none"> ■ Link Up: Enable/disable Link up trap. ■ Link Down: Enable/disable Link down trap. ■ LLDP: Enable/disable LLDP trap. |
| <ul style="list-style-type: none"> • AAA | <p>Indicates that the AAA group's traps. Possible traps are:</p> <ul style="list-style-type: none"> ■ Authentication Fail: Enable/disable SNMP trap authentication failure trap. |
| <ul style="list-style-type: none"> • Switch | <p>Indicates that the Switch group's traps. Possible traps are:</p> <ul style="list-style-type: none"> ■ STP: Enable/disable STP trap. ■ RMON: Enable/disable RMON trap. |

Buttons

: Click to apply changes

: Click to undo any changes made locally and revert to previously saved values.

4.2.2.4 SNMP System Information

The switch system information is provided here. The SNMP System Information screen in [Figure 4-2-2-4](#) appears.



Figure 4-2-2-4: System Information Configuration Page Screenshot

The page includes the following fields:

| Object | Description |
|--|--|
| <ul style="list-style-type: none"> • System Contact | The textual identification of the contact person for this managed node, together with information on how to contact this person. The allowed string length is 0 to 255, and the allowed content is the ASCII characters from 32 to 126. |
| <ul style="list-style-type: none"> • System Name | An administratively assigned name for this managed node. By convention, this is the node's fully-qualified domain name. A domain name is a text string drawn from the alphabet (A-Za-z), digits (0-9), minus sign (-). No space characters are permitted as part of a name. The first character must be an alpha character. And the first or last character must not be a minus sign. The allowed string length is 0 to 255. |
| <ul style="list-style-type: none"> • System Location | The physical location of this node(e.g., telephone closet, 3rd floor). The allowed string length is 0 to 255, and the allowed content is the ASCII characters from 32 to 126. |

4.2.2.5 SNMPv3 Communities

Configure SNMPv3 communities table on this page. The entry index key is Community. The [SNMPv3 Communities](#) screen in [Figure 4-2-2-5](#) appears.



Figure 4-2-2-5: [SNMPv3 Communities](#) Configuration Page Screenshot

The page includes the following fields:

| Object | Description |
|----------------------|---|
| • Delete | Check to delete the entry. It will be deleted during the next save. |
| • Community | Indicates the community access string to permit access to SNMPv3 agent. The allowed string length is 1 to 32, and the allowed content is ASCII characters from 33 to 126. The community string will be treated as security name and map a SNMPv1 or SNMPv2c community string. |
| • Source IP | Indicates the SNMP access source address. A particular range of source addresses can be used to restrict source subnet when combined with source mask. |
| • Source Mask | Indicates the SNMP access source address mask. |

Buttons

: Click to add a new community entry.

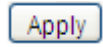
: Click to apply changes

: Click to undo any changes made locally and revert to previously saved values.

4.2.2.6 SNMPv3 Users

Configure SNMPv3 users table on this page. The entry index keys are Engine ID and User Name. The SNMPv3 Users screen in Figure 4-2-2-6 appears.

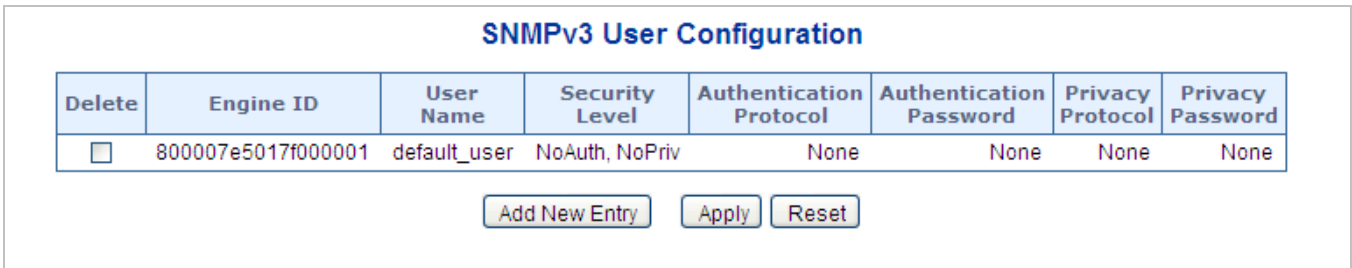

Figure 4-2-2-6: SNMPv3 Users Configuration Page Screenshot

The page includes the following fields:

| Object | Description |
|--|--|
| <ul style="list-style-type: none"> • Delete | Check to delete the entry. It will be deleted during the next save. |
| <ul style="list-style-type: none"> • Engine ID | <p>An octet string identifying the engine ID that this entry should belong to. The string must contain an even number(in hexadecimal format) with number of digits between 10 and 64, but all-zeros and all-'F's are not allowed. The SNMPv3 architecture uses the User-based Security Model (USM) for message security and the View-based Access Control Model (VACM) for access control. For the USM entry, the usmUserEngineID and usmUserName are the entry's keys.</p> <p>In a simple agent, usmUserEngineID is always that agent's own snmpEngineID value. The value can also take the value of the snmpEngineID of a remote SNMP engine with which this user can communicate. In other words, if user engine ID equal system engine ID then it is local user; otherwise it's remote user.</p> |
| <ul style="list-style-type: none"> • User Name | A string identifying the user name that this entry should belong to. The allowed string length is 1 to 32, and the allowed content is ASCII characters from 33 to 126. |
| <ul style="list-style-type: none"> • Security Level | <p>Indicates the security model that this entry should belong to. Possible security models are:</p> <ul style="list-style-type: none"> ■ NoAuth, NoPriv: None authentication and none privacy. ■ Auth, NoPriv: Authentication and none privacy. ■ Auth, Priv: Authentication and privacy. <p>The value of security level cannot be modified if entry already exist. That means must first ensure that the value is set correctly.</p> |
| <ul style="list-style-type: none"> • Authentication Protocol | <p>Indicates the authentication protocol that this entry should belong to. Possible authentication protocol are:</p> <ul style="list-style-type: none"> ■ None: None authentication protocol. |

| | |
|--|---|
| | <ul style="list-style-type: none"> ■ MD5: An optional flag to indicate that this user using MD5 authentication protocol. ■ SHA: An optional flag to indicate that this user using SHA authentication protocol. <p>The value of security level cannot be modified if entry already exist. That means must first ensure that the value is set correctly.</p> |
| <ul style="list-style-type: none"> • Authentication Password | <p>A string identifying the authentication pass phrase. For MD5 authentication protocol, the allowed string length is 8 to 32. For SHA authentication protocol, the allowed string length is 8 to 40. The allowed content is the ASCII characters from 33 to 126.</p> |
| <ul style="list-style-type: none"> • Privacy Protocol | <p>Indicates the privacy protocol that this entry should belong to. Possible privacy protocol are:</p> <ul style="list-style-type: none"> ■ None: None privacy protocol. ■ DES: An optional flag to indicate that this user using DES authentication protocol. ■ AES: An optional flag to indicate that this user uses AES authentication protocol. |
| <ul style="list-style-type: none"> • Privacy Password | <p>A string identifying the privacy pass phrase. The allowed string length is 8 to 32, and the allowed content is the ASCII characters from 33 to 126.</p> |

Buttons



: Click to add a new user entry.

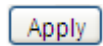

: Click to apply changes



: Click to undo any changes made locally and revert to previously saved values.

4.2.2.7 SNMPv3 Groups

Configure SNMPv3 groups table on this page. The entry index keys are Security Model and Security Name. The SNMPv3 Groups screen in [Figure 4-2-2-7](#) appears.

SNMPv3 Group Configuration

| Delete | Security Model | Security Name | Group Name |
|--------------------------|----------------|---------------|------------------|
| <input type="checkbox"/> | v1 | public | default_ro_group |
| <input type="checkbox"/> | v1 | private | default_rw_group |
| <input type="checkbox"/> | v2c | public | default_ro_group |
| <input type="checkbox"/> | v2c | private | default_rw_group |
| <input type="checkbox"/> | usm | default_user | default_rw_group |

Figure 4-2-2-7: SNMPv3 Groups Configuration Page Screenshot

The page includes the following fields:

| Object | Description |
|---|---|
| <ul style="list-style-type: none"> • Delete | Check to delete the entry. It will be deleted during the next save. |
| <ul style="list-style-type: none"> • Security Model | Indicates the security model that this entry should belong to. Possible security models are: <ul style="list-style-type: none"> ■ v1: Reserved for SNMPv1. ■ v2c: Reserved for SNMPv2c. ■ usm: User-based Security Model (USM). |
| <ul style="list-style-type: none"> • Security Name | A string identifying the security name that this entry should belong to. The allowed string length is 1 to 32, and the allowed content is the ASCII characters from 33 to 126. |
| <ul style="list-style-type: none"> • Group Name | A string identifying the group name that this entry should belong to. The allowed string length is 1 to 32, and the allowed content is the ASCII characters from 33 to 126. |

Buttons

- Add New Entry**: Click to add a new group entry.
- Apply**: Click to apply changes
- Reset**: Click to undo any changes made locally and revert to previously saved values.

4.2.2.8 SNMPv3 Views

Configure SNMPv3 views table on this page. The entry index keys are View Name and OID Subtree. The SNMPv3 Views screen in [Figure 4-2-2-8](#) appears.



Figure 4-2-2-8: SNMPv3 Views Configuration Page Screenshot

The page includes the following fields:

| Object | Description |
|---|---|
| <ul style="list-style-type: none"> • Delete | Check to delete the entry. It will be deleted during the next save. |

| | |
|--|--|
| <ul style="list-style-type: none"> • View Name | <p>A string identifying the view name that this entry should belong to. The allowed string length is 1 to 32, and the allowed content is the ASCII characters from 33 to 126.</p> |
| <ul style="list-style-type: none"> • View Type | <p>Indicates the view type that this entry should belong to. Possible view type are:</p> <ul style="list-style-type: none"> ■ included: An optional flag to indicate that this view subtree should be included. ■ excluded: An optional flag to indicate that this view subtree should be excluded. <p>In general, if a view entry's view type is 'excluded', it should be exist another view entry which view type is 'included' and it's OID subtree overstep the 'excluded' view entry.</p> |
| <ul style="list-style-type: none"> • OID Subtree | <p>The OID defining the root of the subtree to add to the named view. The allowed OID length is 1 to 128. The allowed string content is digital number or asterisk(*).</p> |

Buttons

- Add New Entry**: Click to add a new view entry.
- Apply**: Click to apply changes
- Reset**: Click to undo any changes made locally and revert to previously saved values.

4.2.2.9 SNMPv3 Access

Configure SNMPv3 accesses table on this page. The entry index keys are Group Name, Security Model and Security Level. The SNMPv3 Access screen in [Figure 4-2-2-9](#) appears.

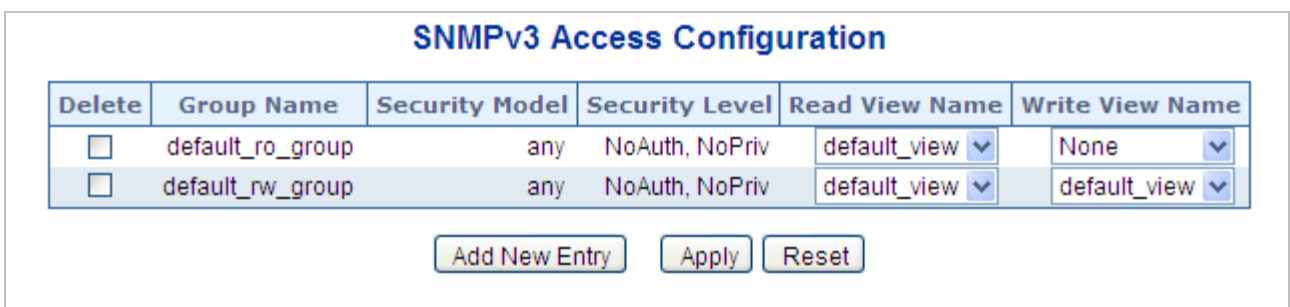



Figure 4-2-2-9: SNMPv3 Accesses Configuration Page Screenshot

The page includes the following fields:

| Object | Description |
|--|---|
| <ul style="list-style-type: none"> • Delete | Check to delete the entry. It will be deleted during the next save. |
| <ul style="list-style-type: none"> • Group Name | A string identifying the group name that this entry should belong to. The allowed string length is 1 to 32, and the allowed content is the ASCII characters from 33 to 126. |
| <ul style="list-style-type: none"> • Security Model | Indicates the security model that this entry should belong to. Possible security models are: <ul style="list-style-type: none"> ■ any: Accepted any security model (v1 v2c usm). ■ v1: Reserved for SNMPv1. ■ v2c: Reserved for SNMPv2c. ■ usm: User-based Security Model (USM) |
| <ul style="list-style-type: none"> • Security Level | Indicates the security model that this entry should belong to. Possible security models are: <ul style="list-style-type: none"> ■ NoAuth, NoPriv: None authentication and none privacy. ■ Auth, NoPriv: Authentication and none privacy. ■ Auth, Priv: Authentication and privacy. |
| <ul style="list-style-type: none"> • Read View Name | The name of the MIB view defining the MIB objects for which this request may request the current values. The allowed string length is 1 to 32, and the allowed content is the ASCII characters from 33 to 126. |
| <ul style="list-style-type: none"> • Write View Name | The name of the MIB view defining the MIB objects for which this request may potentially SET new values. The allowed string length is 1 to 32, and the allowed content is the ASCII characters from 33 to 126. |

Buttons

: Click to add a new access entry.

: Click to apply changes

: Click to undo any changes made locally and revert to previously saved values.

4.2.3 RMON

RMON is the most important expansion of the standard SNMP. RMON is a set of MIB definitions, used to define standard network monitor functions and interfaces, enabling the communication between SNMP management terminals and remote monitors. RMON provides a highly efficient method to monitor actions inside the subnets.

MID of RMON consists of 10 groups. The switch supports the most frequently used groups 1, 2, 3 and 9:

- **Statistics:** Maintain basic usage and error statistics for each subnet monitored by the agent.
- **History:** Record periodical statistic samples available from statistics.
- **Alarm:** Allow management console users to set any count or integer for sample intervals and alert thresholds for RMON agent records.
- **Event:** A list of all events generated by RMON agent.

Alarm depends on the implementation of Event. Statistics and History display some current or history subnet statistics. Alarm and Event provide a method to monitor any integer data change in the network, and provide some alerts upon abnormal events (sending Trap or record in logs).

4.2.3.1 RMON Alarm Configuration

Configure RMON Alarm table on this page. The entry index key is **ID**.; screen in [Figure 4-2-3-1](#) appears.

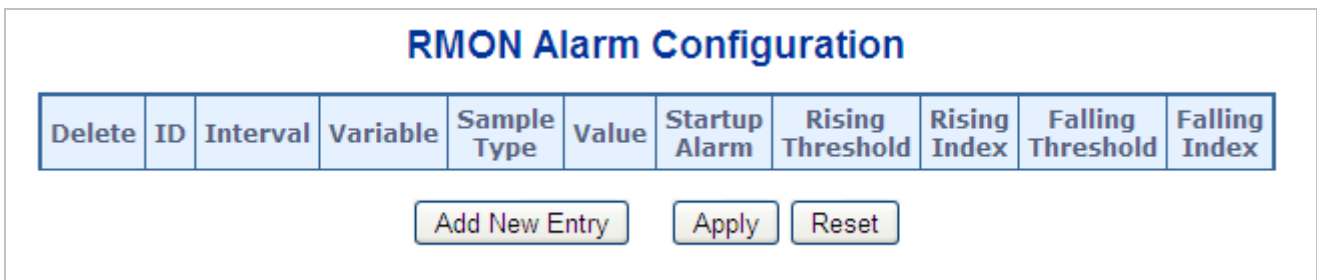

Figure 4-2-3-1: RMON Alarm Configuration Page Screenshot

The page includes the following fields:

| Object | Description |
|-------------------|---|
| • Delete | Check to delete the entry. It will be deleted during the next save. |
| • ID | Indicates the index of the entry. The range is from 1 to 65535. |
| • Interval | Indicates the interval in seconds for sampling and comparing the rising and falling threshold. The range is from 1 to 2 ³¹ -1. |
| • Variable | Indicates the particular variable to be sampled; the possible variables are: <ul style="list-style-type: none"> ■ InOctets: The total number of octets received on the interface, including framing characters. ■ InUcastPkts: The number of uni-cast packets delivered to a higher-layer |

| | |
|----------------------------|--|
| | <p>protocol.</p> <ul style="list-style-type: none"> ■ InNUcastPkts: The number of broadcast and multi-cast packets delivered to a higher-layer protocol. ■ InDiscards: The number of inbound packets that are discarded even the packets are normal. ■ InErrors: The number of inbound packets that contains errors preventing them from being deliverable to a higher-layer protocol. ■ InUnknownProtos: the number of the inbound packets that is discarded because of the unknown or un-support protocol. ■ OutOctets: The number of octets transmitted out of the interface, including framing characters. ■ OutUcastPkts: The number of uni-cast packets that requests to transmit. ■ OutNUcastPkts: The number of broadcast and multi-cast packets that requests to transmit. ■ OutDiscards: The number of outbound packets that is discarded even the packets are normal. ■ OutErrors: The number of outbound packets that could not be transmitted because of errors. ■ OutQLen: The length of the output packet queue (in packets). |
| • Sample Type | <p>The method of sampling the selected variable and calculating the value to be compared against the thresholds; possible sample types are:</p> <ul style="list-style-type: none"> ■ Absolute: Get the sample directly. ■ Delta: Calculate the difference between samples (default). |
| • Value | <p>The value of the statistic during the last sampling period.</p> |
| • Startup Alarm | <p>The method of sampling the selected variable and calculating the value to be compared against the thresholds; possible sample types are:</p> <ul style="list-style-type: none"> ■ Rising Trigger alarm when the first value is larger than the rising threshold. ■ Falling Trigger alarm when the first value is less than the falling threshold. ■ RisingOrFalling Trigger alarm when the first value is larger than the rising threshold or less than the falling threshold (default). |
| • Rising Threshold | <p>Rising threshold value (-2147483648-2147483647).</p> |
| • Rising Index | <p>Rising event index (1-65535).</p> |
| • Falling Threshold | <p>Falling threshold value (-2147483648-2147483647)</p> |
| • Falling Index | <p>Falling event index (1-65535).</p> |

Buttons

Add New Entry: Click to add a new community entry.

Apply: Click to apply changes

Reset: Click to undo any changes made locally and revert to previously saved values.

4.2.3.2 RMON Alarm Status

This page provides an overview of RMON Alarm entries. Each page shows up to 99 entries from the Alarm table, default being 20, selected through the "entries per page" input field. When first visited, the web page will show the first 20 entries from the beginning of the Alarm table. The first displayed will be the one with the lowest ID found in the Alarm table; screen in [Figure 4-2-3-2](#) appears.



Figure 4-2-3-2: RMON Alarm Overview Page Screenshot

The page includes the following fields:

| Object | Description |
|---------------------|---|
| • ID | Indicates the index of Alarm control entry. |
| • Interval | Indicates the interval in seconds for sampling and comparing the rising and falling threshold. |
| • Variable | Indicates the particular variable to be sampled. |
| • Sample Type | The method of sampling the selected variable and calculating the value to be compared against the thresholds. |
| • Value | The value of the statistic during the last sampling period. |
| • Startup Alarm | The alarm that may be sent when this entry is first set to valid. |
| • Rising Threshold | Rising threshold value |
| • Rising Index | Rising event index |
| • Falling Threshold | Falling threshold value |
| • Falling Index | Falling event index |

Buttons

: Click to refresh the page immediately.

Auto-refresh : Check this box to refresh the page automatically. Automatic refresh occurs every 3 seconds.

: Updates the table, starting from the first entry in the Alarm Table, i.e. the entry with the lowest ID.

: Updates the table, starting with the entry after the last entry currently displayed.

4.2.3.3 RMON Event Configuration

Configure RMON Event table on this page. The entry index key is **ID**; screen in [Figure 4-2-3-3](#) appears.

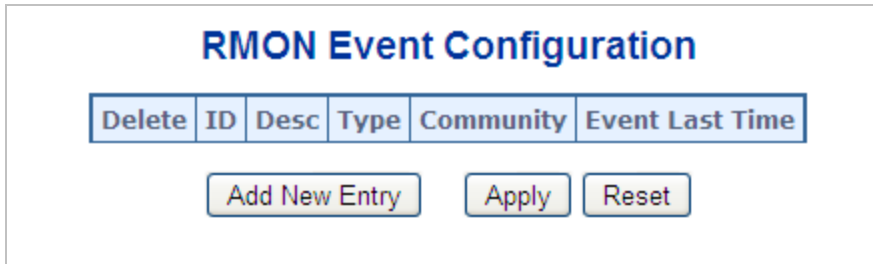





Figure 4-2-3-3 RMON Event Configuration Page Screenshot

The page includes the following fields:

| Object | Description |
|--------------------------|---|
| • Delete | Check to delete the entry. It will be deleted during the next save. |
| • ID | Indicates the index of the entry. The range is from 1 to 65535. |
| • Desc | Indicates this event, the string length is from 0 to 127, default is a null string. |
| • Type | Indicates the notification of the event; the possible types are: <ul style="list-style-type: none"> ■ none: The total number of octets received on the interface, including framing characters. ■ log: The number of uni-cast packets delivered to a higher-layer protocol. ■ snmptrap: The number of broad-cast and multi-cast packets delivered to a higher-layer protocol. ■ logandtrap: The number of inbound packets that are discarded even the packets are normal. |
| • Community | Specify the community when trap is sent, the string length is from 0 to 127, default is "public". |
| • Event Last Time | Indicates the value of sysUpTime at the time this event entry last generated an event. |

Buttons

- : Click to add a new community entry.
- : Click to apply changes
- : Click to undo any changes made locally and revert to previously saved values.

4.2.3.4 RMON Event Status

This page provides an overview of RMON Event table entries. Each page shows up to 99 entries from the Event table, default being 20, selected through the "entries per page" input field. When first visited, the web page will show the first 20 entries from the beginning of the Event table. The first displayed will be the one with the lowest Event Index and Log Index found in the Event table; screen in [Figure 4-2-3-4](#) appears.

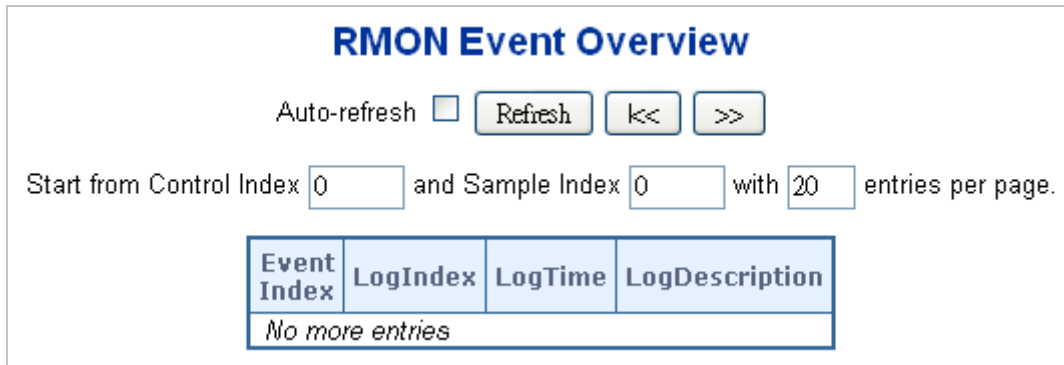



Figure 4-2-3-4: RMON Event Overview Page Screenshot

The page includes the following fields:

| Object | Description |
|--------------------------|---|
| • Event Index | Indicates the index of the event entry. |
| • Log Index | Indicates the index of the log entry. |
| • Logtime | Indicates Event log time. |
| • Log Description | Indicates the Event description. |

Buttons

: Click to refresh the page immediately.

Auto-refresh : Check this box to refresh the page automatically. Automatic refresh occurs every 3 seconds.

: Updates the table starting from the first entry in the Alarm Table, i.e. the entry with the lowest ID.

: Updates the table, starting with the entry after the last entry currently displayed.

: Updates the table, starting with the entry after the last entry currently displayed.

4.2.3.5 RMON History Configuration

Configure RMON History table on this page. The entry index key is **ID**; screen in [Figure 4-2-3-5](#) appears.

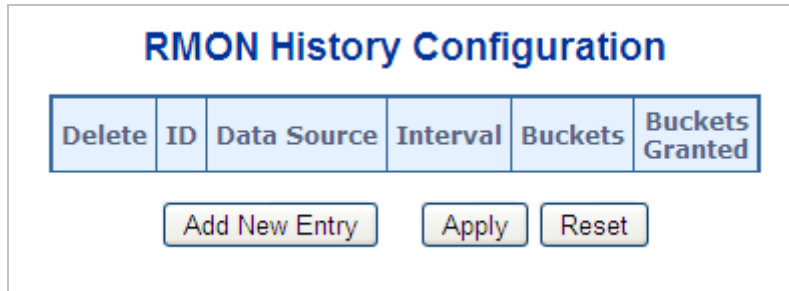

Figure 4-2-3-5: RMON History Configuration Page Screenshot

The page includes the following fields:

| Object | Description |
|--------------------------|--|
| • Delete | Check to delete the entry. It will be deleted during the next save. |
| • ID | Indicates the index of the entry. The range is from 1 to 65535. |
| • Data Source | Indicates the port ID which wants to be monitored. |
| • Interval | Indicates the interval in seconds for sampling the history statistics data. The range is from 1 to 3600, default value is 1800 seconds. |
| • Buckets | Indicates the maximum data entries associated this History control entry stored in RMON. The range is from 1 to 3600, default value is 50. |
| • Buckets Granted | The number of data will be saved in the RMON. |

Buttons

Add New Entry: Click to add a new community entry.

Apply: Click to apply changes

Reset: Click to undo any changes made locally and revert to previously saved values.

4.2.3.6 RMON History Status

This page provides an detail of RMON history entries; screen in [Figure 4-2-3-6](#) appears.

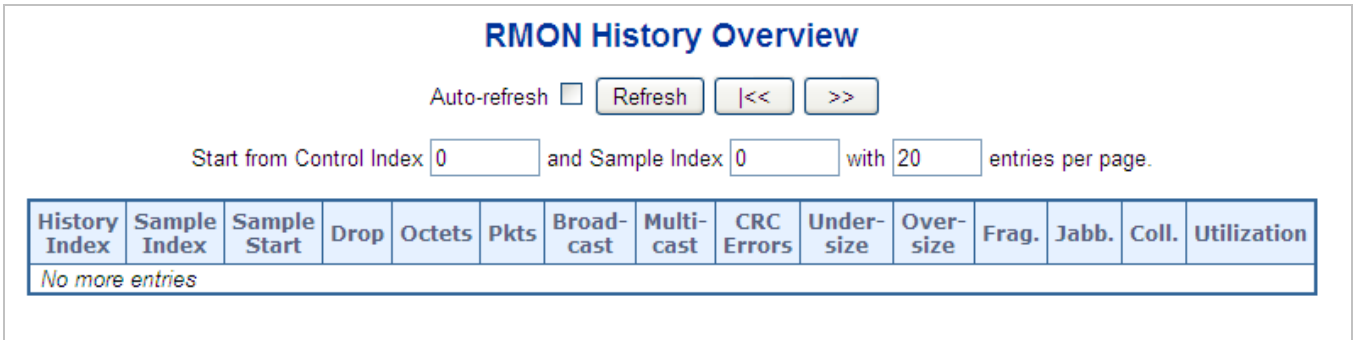

Figure 4-2-3-6: RMON History Overview Page Screenshot

The page includes the following fields:

| Object | Description |
|------------------------|--|
| • History Index | Indicates the index of History control entry. |
| • Sample Index | Indicates the index of the data entry associated with the control entry. |
| • Sample Start | The value of sysUpTime at the start of the interval over which this sample was measured. |
| • Drop | The total number of events in which packets were dropped by the probe due to lack of resources. |
| • Octets | The total number of octets of data (including those in bad packets) received on the network. |
| • Pkts | The total number of packets (including bad packets, broadcast packets, and multicast packets) received. |
| • Broadcast | The total number of good packets received that were directed to the broadcast address. |
| • Multicast | The total number of good packets received that were directed to a multicast address. |
| CRC Errors | The total number of packets received that had a length (excluding framing bits, but including FCS octets) of between 64 and 1518 octets, inclusive, but had either a bad Frame Check Sequence (FCS) with an integral number of octets (FCS Error) or a bad FCS with a non-integral number of octets (Alignment Error). |
| • Undersize | The total number of packets received that were less than 64 octets. |
| • Oversize | The total number of packets received that were longer than 1518 octets. |
| • Frag. | The number of frames whose size is less than 64 octets received with invalid CRC. |
| • Jabb. | The number of frames whose size is larger than 64 octets received with invalid CRC. |
| • Coll. | The best estimate of the total number of collisions in this Ethernet segment. |

| | |
|--|---|
| <ul style="list-style-type: none"> • Utilization | The best estimate of the mean physical layer network utilization on this interface during this sampling interval, in hundredths of a percent. |
|--|---|

Buttons

: Click to refresh the page immediately.

Auto-refresh Check this box to refresh the page automatically. Automatic refresh occurs every 3 seconds.

: Updates the table, starting from the first entry in the History table, i.e., the entry with the lowest History

Index and Sample Index

: Updates the table, starting with the entry after the last entry currently displayed.

4.2.3.7 RMON Statistics Configuration

Configure RMON Statistics table on this page. The entry index key is **ID**; screen in [Figure 4-2-3-7](#) appears.





Figure 4-2-3-7: RMON Statistics Configuration Page Screenshot

The page includes the following fields:

| Object | Description |
|--|---|
| <ul style="list-style-type: none"> • Delete | Check to delete the entry. It will be deleted during the next save. |
| <ul style="list-style-type: none"> • ID | Indicates the index of the entry. The range is from 1 to 65535. |
| <ul style="list-style-type: none"> • Data Source | Indicates the port ID which wants to be monitored. |

Buttons

: Click to add a new community entry.

: Click to apply changes

: Click to undo any changes made locally and revert to previously saved values.

4.2.3.8 RMON Statistics Status

This page provides an overview of RMON Statistics entries. Each page shows up to 99 entries from the Statistics table, default being 20, selected through the "entries per page" input field. When first visited, the web page will show the first 20 entries from the beginning of the Statistics table. The first displayed will be the one with the lowest ID found in the Statistics table; screen in Figure 4-2-3-8 appears.

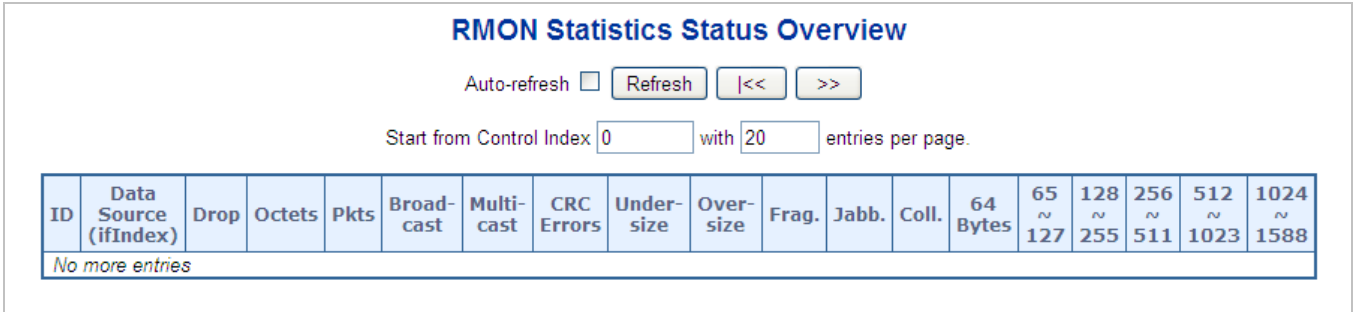



Figure 4-2-3-8: RMON Statistics Status Overview Page Screenshot

The page includes the following fields:

| Object | Description |
|-------------------------|--|
| • ID | Indicates the index of Statistics entry. |
| • Data Source (ifIndex) | The port ID which wants to be monitored. |
| • Drop | The total number of events in which packets were dropped by the probe due to lack of resources. |
| • Octets | The total number of octets of data (including those in bad packets) received on the network. |
| • Pkts | The total number of packets (including bad packets, broadcast packets, and multicast packets) received. |
| • Broadcast | The total number of good packets received that were directed to the broadcast address. |
| • Multicast | The total number of good packets received that were directed to a multicast address. |
| • CRC Errors | The total number of packets received that had a length (excluding framing bits, but including FCS octets) of between 64 and 1518 octets. |
| • Undersize | The total number of packets received that were less than 64 octets. |
| • Oversize | The total number of packets received that were longer than 1518 octets. |
| • Frag. | The number of frames whose size is less than 64 octets received with invalid CRC. |
| • Jabb. | The number of frames whose size is larger than 64 octets received with invalid CRC. |

| | |
|-------------|---|
| • Coll. | The best estimate of the total number of collisions in this Ethernet segment. |
| • 64 Bytes | The total number of packets (including bad packets) received that were 64 octets in length. |
| • 65~127 | The total number of packets (including bad packets) received that were between 65 to 127 octets in length. |
| • 128~255 | The total number of packets (including bad packets) received that were between 128 to 255 octets in length. |
| • 256~511 | The total number of packets (including bad packets) received that were between 256 to 511 octets in length. |
| • 512~1023 | The total number of packets (including bad packets) received that were between 512 to 1023 octets in length. |
| • 1024~1518 | The total number of packets (including bad packets) received that were between 1024 to 1518 octets in length. |

Buttons

: Click to refresh the page immediately.

Auto-refresh Check this box to refresh the page automatically. Automatic refresh occurs every 3 seconds.

: Updates the table, starting from the first entry in the Alarm Table, i.e. the entry with the lowest ID.

: Updates the table, starting with the entry after the last entry currently displayed.

4.2.4 DHCP server

4.2.4.1 DHCP Server Mode Configuration

Configure DHCP server mode on this page. The entry index key is **ID.**; screen in [Figure 4-2-4-1](#) appears.

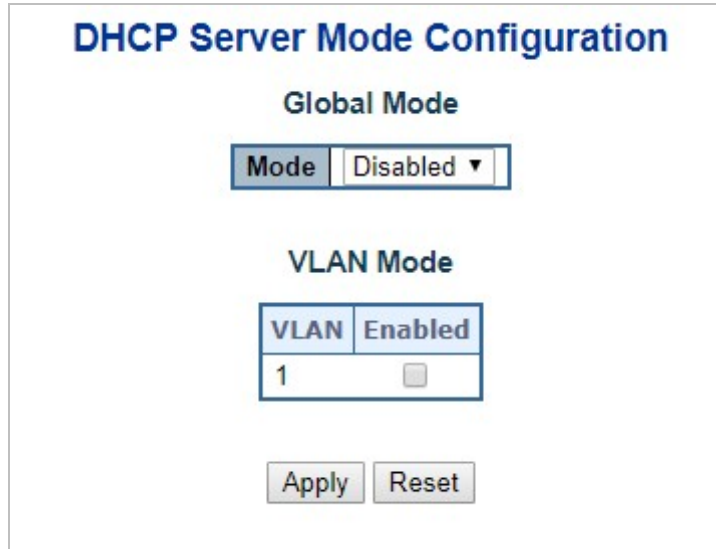

Figure 4-2-4-1: DHCP server mode Page Screenshot

The page includes the following fields:

| Object | Description |
|---|--|
| <ul style="list-style-type: none"> • Mode | Configure the operation mode per system. Possible modes are: Enabled : Enable DHCP server per system. Disabled : Disable DHCP server pre system. |
| <ul style="list-style-type: none"> • VLAN Mode | Configure operation mode to enable/disable DHCP server per VLAN. |
| <ul style="list-style-type: none"> • VLAN Range | Indicate the VLAN range in which DHCP server is enabled or disabled. The first VLAN ID must be smaller than or equal to the second VLAN ID. BUT, if the VLAN range contains only 1 VLAN ID, then you can just input it into either one of the first and second VLAN ID or both. On the other hand, if you want to disable existed VLAN range, then you can follow the steps. 1. press + to add a new VLAN range. 2. input the VLAN range that you want to disable. 3. choose Mode to be Disabled . 4. press OK to apply the change. Then, you will see the disabled VLAN range is removed from the DHCP Server mode configuration page. |

| | |
|---|---|
| <ul style="list-style-type: none"> • Mode | <ul style="list-style-type: none"> ■ Indicate the operation mode per VLAN. Possible modes are: <ul style="list-style-type: none"> Enabled: Enable DHCP server per VLAN. Disabled: Disable DHCP server pre VLAN. |
|---|---|

Buttons

Add VLAN Range: Click to add a new VLAN range.

Apply: Click to apply changes

Reset: Click to undo any changes made locally and revert to previously saved values.

4.2.4.2 DHCP Server excluded IP Configuration

Configure excluded IP addresses. DHCP server will not allocate these excluded IP addresses to DHCP client.; screen in [Figure 4-2-4-2](#) appears.



Figure 4-2-4-2: DHCP server excluded Page Screenshot

The page includes the following fields:

| Object | Description |
|---|---|
| <ul style="list-style-type: none"> • IP range | Define the IP range to be excluded IP addresses. The first excluded IP must be smaller than or equal to the second excluded IP. BUT, if the IP range contains only 1 excluded IP, then you can just input it to either one of the first and second excluded IP or both. |

Buttons

Add IP Range: Click to add a new excluded IP range.

Apply: Click to apply changes

Reset: Click to undo any changes made locally and revert to previously saved values.

4.2.4.3 DHCP Server pool Configuration

This page manages DHCP pools. According to the DHCP pool, DHCP server will allocate IP address and deliver configuration parameters to DHCP client. screen in [Figure 4-2-4-3](#) appears.



Figure 4-2-4-3: DHCP server pool Page Screenshot

The page includes the following fields:

| Object | Description |
|--|---|
| <ul style="list-style-type: none"> Name | Configure the pool name that accepts all printable characters, except white space. If you want to configure the detail settings, you can click the pool name to go into the configuration page. |
| <ul style="list-style-type: none"> Type | Display which type of the pool is. Network: the pool defines a pool of IP addresses to service more than one DHCP client. Host: the pool services for a specific DHCP client identified by client identifier or hardware address. |
| <ul style="list-style-type: none"> IP | Display network number of the DHCP address pool. If "-" is displayed, it means not defined |
| <ul style="list-style-type: none"> Subnet Mask | Display subnet mask of the DHCP address pool. If "-" is displayed, it means not defined. |
| <ul style="list-style-type: none"> Lease Time | Display lease time of the pool. |

Buttons

: Click to add a new excluded IP range.

: Click to apply changes

: Click to undo any changes made locally and revert to previously saved values.

4.2.4.4 DHCP Server pool Configuration

This page displays the database counters and the number of DHCP messages sent and received by DHCP server.. screen in [Figure 4-2-4-4](#) appears.

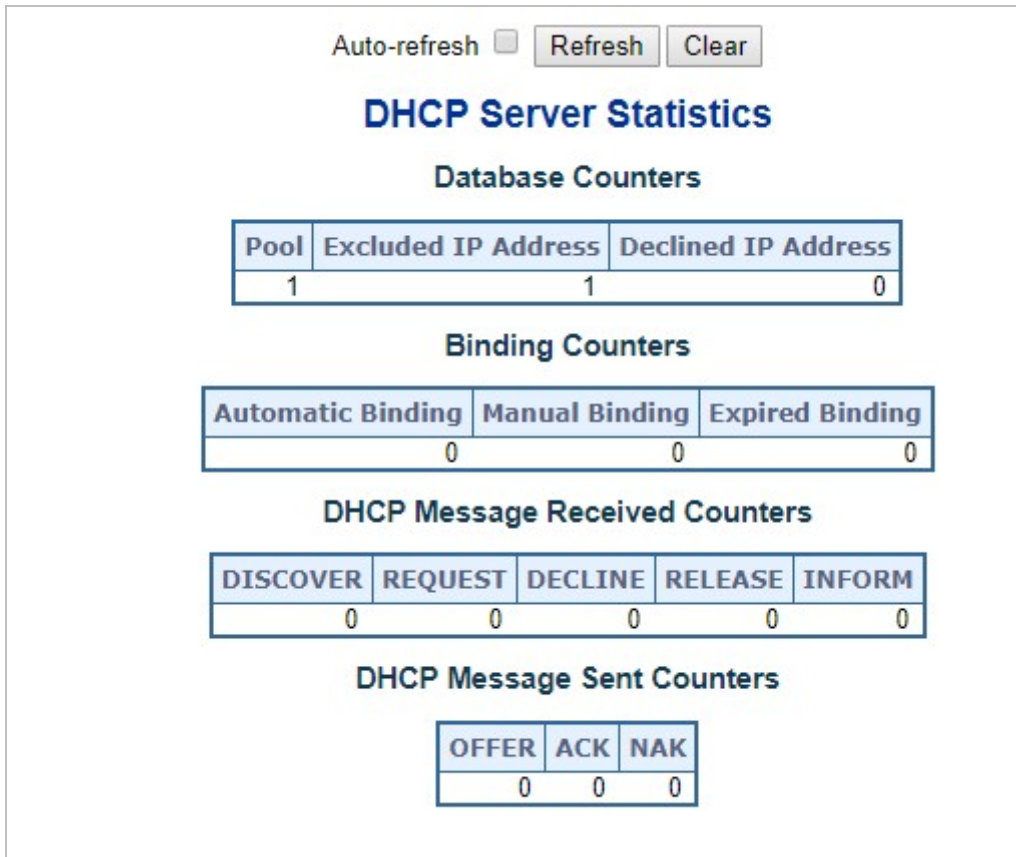

Figure 4-2-4-4: DHCP server Statistics Page Screenshot

The page includes the following fields:

Database Counters

| Object | Description |
|-----------------------|--------------------------------------|
| • Pool | Number of pools |
| • Excluded IP Address | Number of excluded IP address ranges |
| • Declined IP Address | Number of declined IP addresses. |

Binding Counters

| Object | Description |
|---------------------|---|
| • Automatic Binding | Number of bindings with network-type pools |
| • Manual Binding | Number of bindings that administrator assigns an IP address to a client. That is, the pool is of host type. |

| | |
|--|---|
| <ul style="list-style-type: none"> • Expired Binding | Number of bindings that their lease time expired or they are cleared from Automatic/Manual type bindings. |
|--|---|

DHCP message Received Counters

| Object | Description |
|---|--|
| <ul style="list-style-type: none"> • Discover | Number of DHCP DISCOVER messages received. |
| <ul style="list-style-type: none"> • Request | Number of DHCP REQUEST messages received. |
| <ul style="list-style-type: none"> • Decline | Number of DHCP DECLINE messages received. |
| <ul style="list-style-type: none"> • Release | Number of DHCP RELEASE messages received. |
| <ul style="list-style-type: none"> • Inform | Number of DHCP INFORM messages received. |

DHCP message Sent Counters

| Object | Description |
|--|-------------------------------------|
| <ul style="list-style-type: none"> • Offer | Number of DHCP OFFER messages sent. |
| <ul style="list-style-type: none"> • ACK | Number of DHCP ACK messages sent. |
| <ul style="list-style-type: none"> • NAK | Number of DHCP NAK messages sent. |

Buttons

Auto-refresh seconds. : Check this box to refresh the page automatically.

Apply : Click to apply changes

Reset : Click to undo any changes made locally and revert to previously saved values

4.2.4.5 DHCP Server Binding IP Configuration

This page displays bindings generated for DHCP clients. screen in [Figure 4-2-4-5](#) appears.

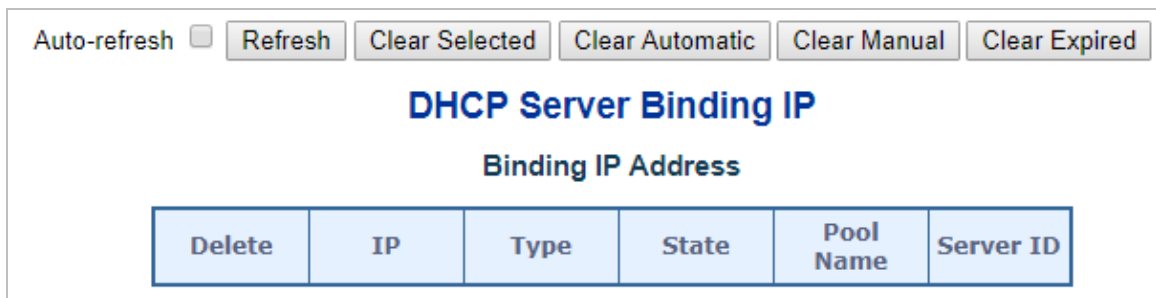

Figure 4-2-4-5: DHCP server Binding IP page Screenshot

The page includes the following fields:

| Object | Description |
|-------------|---|
| • IP | Display IP address allocated to DHCP client. |
| • Type | Display type of binding. Possible types are Automatic, Manual, Expired. |
| • State | Display state of binding. Possible states are Committed, Allocated, Expired |
| • Pool Name | Display the pool that generates the binding. |
| • Server ID | Display server IP address to service the binding. |

Buttons

Auto-refresh : Check this box to refresh the page automatically

Refresh : Click to refresh the page immediately.

Clear Selected : Click to clear selected bindings. If the selected binding is Automatic or Manual, then it is changed to be Expired. If the selected binding is Expired, then it is freed.

Clear Automatic : Click to clear all Automatic bindings and Change them to Expired bindings.

Clear Manual : Click to clear all Manual bindings and Change them to Expired bindings.

Clear Expired : Click to clear all Expired bindings and free them.

4.2.4.6 DHCP Server Declined IP

This page displays declined IP addresses. screen in [Figure 4-2-4-6](#) appears.

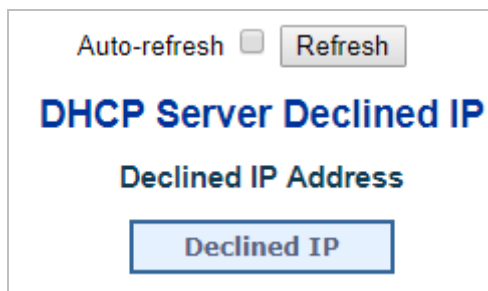

Figure 4-2-4-6: DHCP server Declined IP Page Screenshot

The page includes the following fields:

| Object | Description |
|--|--|
| <ul style="list-style-type: none"> Delined IP | Display List of IP addresses declined. |

Buttons

Auto-refresh : Check this box to refresh the page automatically

: Click to refresh the page immediately.

4.2.4.7 DHCP Detail Statistics

This page provides statistics for DHCP snooping. Notice that the normal forward per-port TX statistics isn't increased if the incoming DHCP packet is done by L3 forwarding mechanism. And clear the statistics on specific port may not take effect on global statistics since it gathers the different layer overview. screen in [Figure 4-2-4-7](#) appears.

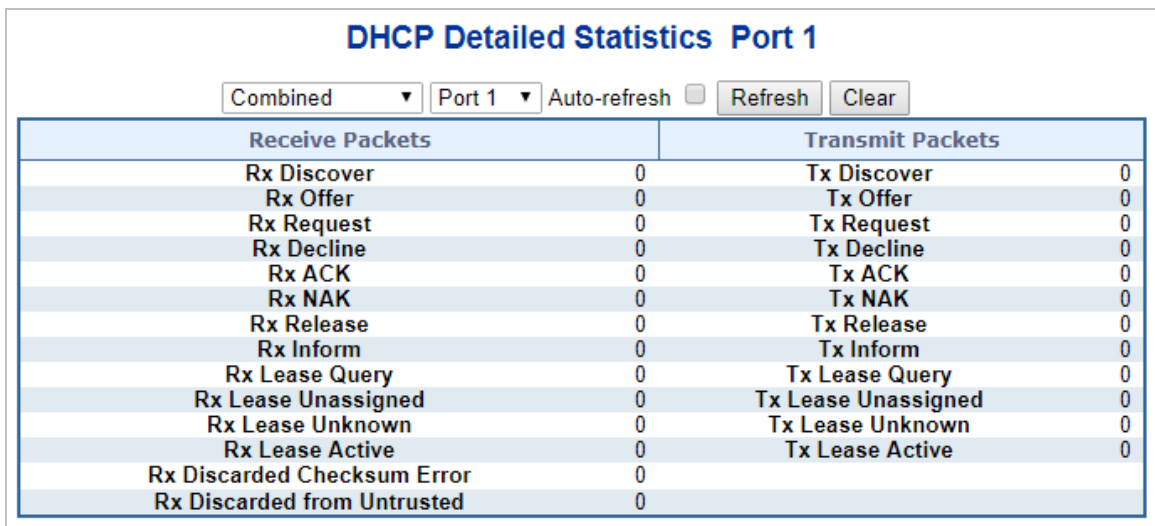

| Combined | Port 1 | Auto-refresh <input type="checkbox"/> | <input type="button" value="Refresh"/> | <input type="button" value="Clear"/> |
|-----------------------------|--------|---------------------------------------|--|--------------------------------------|
| Receive Packets | | Transmit Packets | | |
| Rx Discover | 0 | Tx Discover | 0 | |
| Rx Offer | 0 | Tx Offer | 0 | |
| Rx Request | 0 | Tx Request | 0 | |
| Rx Decline | 0 | Tx Decline | 0 | |
| Rx ACK | 0 | Tx ACK | 0 | |
| Rx NAK | 0 | Tx NAK | 0 | |
| Rx Release | 0 | Tx Release | 0 | |
| Rx Inform | 0 | Tx Inform | 0 | |
| Rx Lease Query | 0 | Tx Lease Query | 0 | |
| Rx Lease Unassigned | 0 | Tx Lease Unassigned | 0 | |
| Rx Lease Unknown | 0 | Tx Lease Unknown | 0 | |
| Rx Lease Active | 0 | Tx Lease Active | 0 | |
| Rx Discarded Checksum Error | 0 | | | |
| Rx Discarded from Untrusted | 0 | | | |

Figure 4-2-4-7: DHCP Detail Statistics page Screenshot

The page includes the following fields:

| Object | Description |
|-------------------------------|--|
| • Rx and Tx Discover | Display the number of discover (option 53 with value 1) packets received and transmitted. |
| • Rx and Tx Offer | Display the number of offer (option 53 with value 2) packets received and transmitted. |
| • Rx and Tx Request | Display the number of request (option 53 with value 3) packets received and transmitted |
| • Rx and Tx Decline | Display the number of decline (option 53 with value 4) packets received and transmitted. |
| • Rx and Tx ACK | Display the number of ACK (option 53 with value 5) packets received and transmitted. |
| • Rx and Tx NAK | Display the number of NAK (option 53 with value 6) packets received and transmitted. |
| • Rx and Tx Release | Display the number of release (option 53 with value 7) packets received and transmitted. |
| • Rx and Tx Inform | Display the number of inform (option 53 with value 8) packets received and transmitted |
| • Rx and Tx Lease Query | Display the number of lease query (option 53 with value 10) packets received and transmitted. |
| • Rx and Tx Lease Unassigned | Display the number of lease unassigned (option 53 with value 11) packets received and transmitted. |
| • Rx and Tx Lease Unknown | Display the number of lease unknown (option 53 with value 12) packets received and transmitted. |
| • Rx and Tx Lease Active | Display the number of lease active (option 53 with value 13) packets received and transmitted |
| • Rx Discarded checksum error | Display the number of discard packet that IP/UDP checksum is error. |
| • Rx Discarded from Untrusted | Display the number of discarded packet that are coming from untrusted port. |

Buttons

Auto-refresh : Check this box to refresh the page automatically

Refresh : Click to refresh the page immediately.

Clear : Clears the counters for the selected ports

4.2.5 Industrial Protocol

With the supported Modbus TCP/IP protocol, the IGS-5225 series can easily integrate with **SCADA** systems, **HMI** systems and other data acquisition systems in factory floors. It enable administrators to remotely monitor the industrial Ethernet switch's **operating information**, **port information** and **communication status**, thus easily achieving enhanced monitoring and maintenance of the entire factory.

4.2.5.1 Protocol Configuration

The Industrial Protocol Configuration are configured here.; screen in [Figure 4-2-5-1](#) appears.

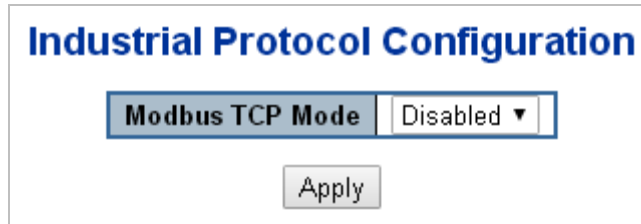



Figure 4-2-5-1: Protocol Configuration Page Screenshot

The page includes the following fields:

| Object | Description |
|--|---|
| <ul style="list-style-type: none"> • Modbus TCP Mode | Indicates the modbus TCP mode operation. Possible modes are: <ul style="list-style-type: none"> ■ Enabled: Enable modbus TCP mode operation. ■ Disabled: Disable modbus TCP mode operation. |

Buttons

: Click to apply changes

4.3 Switching

4.3.1 Port Management

Use the Port Menu to display or configure the **Industrial Managed Switch's** ports. This section has the following items:

- **Port Configuration** Configures port connection settings
- **Port Statistics Overview** Lists Ethernet and RMON port statistics
- **Port Statistics Detail** Lists Ethernet and RMON port statistics
- **SFP Module Information** Display SFP information
- **Port Mirror** Sets the source and target ports for mirroring

4.3.1.1 Port Configuration

This page displays current port configurations. Ports can also be configured here. The Port Configuration screen in [Figure 4-3-1-1](#) appears.

Port Configuration

| Port | Port Description | Link | Speed | | Flow Control | | | Maximum Frame Size |
|------|------------------|--------------------------------------|---------|------------|--------------------------|---------|---------|--------------------|
| | | | Current | Configured | Enable | Curr Rx | Curr Tx | |
| * | | | | <All> | <input type="checkbox"/> | | | 10240 |
| 1 | | ● | Down | Auto | <input type="checkbox"/> | × | × | 10240 |
| 2 | | ● | 1Gfdx | Auto | <input type="checkbox"/> | × | × | 10240 |
| 3 | | ● | Down | Auto | <input type="checkbox"/> | × | × | 10240 |
| 4 | | ● | Down | Auto | <input type="checkbox"/> | × | × | 10240 |
| 5 | | ● | Down | Auto | <input type="checkbox"/> | × | × | 10240 |
| 6 | | ● | Down | Auto | <input type="checkbox"/> | × | × | 10240 |
| 7 | | ● | Down | Auto | <input type="checkbox"/> | × | × | 10240 |
| 10 | | ● | Down | Auto | <input type="checkbox"/> | × | × | 10240 |

Figure 4-3-1-1: Port Configuration Page Screenshot

The page includes the following fields:

| Object | Description |
|-----------------------------|---|
| • Port | This is the logical port number for this row. |
| • Port Description | Indicates the per port description. |
| • Link | The current link state is displayed graphically. Green indicates the link is up and red indicates the link is down. |
| • Current Link Speed | Provides the current link speed of the port. |

| | |
|--|---|
| <ul style="list-style-type: none"> • Configured Link Speed | <p>Select any available link speed for the given switch port. Draw the menu bar to select the mode.</p> <ul style="list-style-type: none"> ■ Auto – Set up Auto negotiation for copper interface. ■ 10Mbps HDX - Force sets 10Mbps/Half-Duplex mode. ■ 10Mbps FDX - Force sets 10Mbps/Full-Duplex mode. ■ 100Mbps HDX - Force sets 100Mbps/Half-Duplex mode. ■ 100Mbps FDX - Force sets 100Mbps/Full-Duplex mode. ■ 1Gbps FDX - Force sets 10000Mbps/Full-Duplex mode. ■ Auto Fiber (10G) – Set up 10G fiber port for negotiation automatically. ■ Disable – Shut down the port manually. |
| <ul style="list-style-type: none"> • Flow Control | <p>When Auto Speed is selected on a port, this section indicates the flow control capability that is advertised to the link partner.</p> <p>When a fixed-speed setting is selected, that is what is used. The Current Rx column indicates whether pause frames on the port are obeyed, and the Current Tx column indicates whether pause frames on the port are transmitted. The Rx and Tx settings are determined by the result of the last Auto-Negotiation.</p> <p>Check the configured column to use flow control. This setting is related to the setting for Configured Link Speed.</p> |
| <ul style="list-style-type: none"> • Maximum Frame Size | <p>Enter the maximum frame size allowed for the switch port, including FCS. The allowed range is 1518 bytes to 10056 bytes.</p> |



When setting each port to run at 100M Full-, 100M Half-, 10M Full-, and 10M Half-speed modes. The Auto-MDIX function will disable.

Buttons

Apply : Click to apply changes

Reset : Click to undo any changes made locally and revert to previously saved values.

Refresh : Click to refresh the page. Any changes made locally will be undone.

4.3.1.2 Port Statistics Overview

This page provides an overview of general traffic statistics for all switch ports. The Port Statistics Overview screen in [Figure 4-3-1-2](#) appears.

| Port | Packets | | Bytes | | Errors | | Drops | | Filtered |
|------|----------|-------------|----------|-------------|----------|-------------|----------|-------------|----------|
| | Received | Transmitted | Received | Transmitted | Received | Transmitted | Received | Transmitted | Received |
| 1 | 1076 | 1047 | 158972 | 862468 | 0 | 0 | 0 | 0 | 0 |
| 2 | 0 | 0 | 0 | 0 | 0 | 0 | 0 | 0 | 0 |
| 3 | 0 | 0 | 0 | 0 | 0 | 0 | 0 | 0 | 0 |
| 4 | 0 | 0 | 0 | 0 | 0 | 0 | 0 | 0 | 0 |
| 5 | 0 | 0 | 0 | 0 | 0 | 0 | 0 | 0 | 0 |
| 6 | 0 | 0 | 0 | 0 | 0 | 0 | 0 | 0 | 0 |
| 7 | 0 | 0 | 0 | 0 | 0 | 0 | 0 | 0 | 0 |
| 8 | 0 | 0 | 0 | 0 | 0 | 0 | 0 | 0 | 0 |

Figure 4-3-1-2: Port Statistics Overview Page Screenshot

The displayed counters are:

| Object | Description |
|-------------------|---|
| • Port | The logical port for the settings contained in the same row. |
| • Packets | The number of received and transmitted packets per port. |
| • Bytes | The number of received and transmitted bytes per port. |
| • Errors | The number of frames received in error and the number of incomplete transmissions per port. |
| • Drops | The number of frames discarded due to ingress or egress congestion. |
| • Filtered | The number of received frames filtered by the forwarding process. |

Buttons

: Download the Port Statistics Overview result in EXCEL file.

: Click to refresh the page immediately.

: Clears the counters for all ports.

: Print the Port Statistics Overview result.

Auto-refresh : Check this box to enable an automatic refresh of the page at regular intervals.

4.3.1.3 Port Statistics Details

This page provides detailed traffic statistics for a specific switch port. Use the port select box to select which switch port details

to display. The displayed counters are the totals for receive and transmit, the size counters for receive and transmit, and the error counters for receive and transmit. The Detailed Port Statistics screen in [Figure 4-3-1-3](#) appears.

| Detailed Port Statistics Port 1 | | | |
|--|--------|-------------------------|---------|
| Port 1 <input type="button" value="Auto-refresh"/> <input type="button" value="Refresh"/> <input type="button" value="Clear"/> | | | |
| Receive Total | | Transmit Total | |
| Rx Packets | 2335 | Tx Packets | 2066 |
| Rx Octets | 431172 | Tx Octets | 1531131 |
| Rx Unicast | 2039 | Tx Unicast | 2050 |
| Rx Multicast | 48 | Tx Multicast | 11 |
| Rx Broadcast | 248 | Tx Broadcast | 5 |
| Rx Pause | 0 | Tx Pause | 0 |
| Receive Size Counters | | Transmit Size Counters | |
| Rx 64 Bytes | 1465 | Tx 64 Bytes | 242 |
| Rx 65-127 Bytes | 175 | Tx 65-127 Bytes | 53 |
| Rx 128-255 Bytes | 66 | Tx 128-255 Bytes | 523 |
| Rx 256-511 Bytes | 553 | Tx 256-511 Bytes | 203 |
| Rx 512-1023 Bytes | 76 | Tx 512-1023 Bytes | 284 |
| Rx 1024-1526 Bytes | 0 | Tx 1024-1526 Bytes | 761 |
| Rx 1527- Bytes | 0 | Tx 1527- Bytes | 0 |
| Receive Queue Counters | | Transmit Queue Counters | |
| Rx Q0 | 2283 | Tx Q0 | 0 |
| Rx Q1 | 0 | Tx Q1 | 0 |
| Rx Q2 | 0 | Tx Q2 | 0 |
| Rx Q3 | 0 | Tx Q3 | 0 |
| Rx Q4 | 0 | Tx Q4 | 0 |
| Rx Q5 | 0 | Tx Q5 | 0 |
| Rx Q6 | 0 | Tx Q6 | 0 |
| Rx Q7 | 0 | Tx Q7 | 2066 |
| Receive Error Counters | | Transmit Error Counters | |
| Rx Drops | 52 | Tx Drops | 0 |
| Rx CRC/Alignment | 0 | Tx Late/Exc. Coll. | 0 |
| Rx Undersize | 0 | | |
| Rx Oversize | 0 | | |
| Rx Fragments | 0 | | |
| Rx Jabber | 0 | | |
| Rx Filtered | 52 | | |

Figure 4-3-1-3: Detailed Port Statistics Port 1 Page Screenshot

The page includes the following fields:

Receive Total and Transmit Total

| Object | Description |
|-----------------------|---|
| • Rx and Tx Packets | The number of received and transmitted (good and bad) packets |
| • Rx and Tx Octets | The number of received and transmitted (good and bad) bytes, including FCS, but excluding framing bits. |
| • Rx and Tx Unicast | The number of received and transmitted (good and bad) unicast packets. |
| • Rx and Tx Multicast | The number of received and transmitted (good and bad) multicast packets. |
| • Rx and Tx Broadcast | The number of received and transmitted (good and bad) broadcast packets. |
| • Rx and Tx Pause | A count of the MAC Control frames received or transmitted on this port that has an opcode indicating a PAUSE operation. |

Receive and Transmit Size Counters

The number of received and transmitted (good and bad) packets split into categories based on their respective frame sizes.

Receive and Transmit Queue Counters

The number of received and transmitted packets per input and output queue.

Receive Error Counters

| Object | Description |
|--------------------|--|
| • Rx Drops | The number of frames dropped due to lack of receive buffers or egress congestion. |
| • Rx CRC/Alignment | The number of frames received with CRC or alignment errors. |
| • Rx Undersize | The number of short frames received with valid CRC. |
| • Rx Oversize | The number of long frames received with valid CRC. |
| • Rx Fragments | The number of short frames received with invalid CRC. |
| • Rx Jabber | The number of long frames received with invalid CRC. |
| • Rx Filtered | The number of received frames filtered by the forwarding process. Short frames are frames that are smaller than 64 bytes. Long frames are frames that are longer than the configured maximum frame length for this port. |



- 1 Short frames are frames that are smaller than 64 bytes.
- 2 Long frames are frames that are longer than the configured maximum frame length for this port.

Transmit Error Counters

| Object | Description |
|----------------------|---|
| • Tx Drops | The number of frames dropped due to output buffer congestion. |
| • Tx Late/Exc. Coll. | The number of frames dropped due to excessive or late collisions. |

Buttons

: Click to refresh the page immediately.

: Clears the counters for all ports.

Auto-refresh : Check this box to enable an automatic refresh of the page at regular intervals.

4.3.1.4 SFP Module Information

The **Industrial Managed Switches** have supported the SFP module with **digital diagnostics monitoring (DDM)** function. This feature is also known as digital optical monitoring (DOM). You can check the physical or

operational status of an SFP module via the SFP Module Information page. This page shows the operational status, such as the transceiver type, speed, wavelength, optical output power, optical input power, temperature, laser bias current and transceiver supply voltage in real time. You can also use the hyperlink of port no. to check the statistics on a specific interface. The SFP Module Information screen in [Figure 4-3-1-4](#) appears.

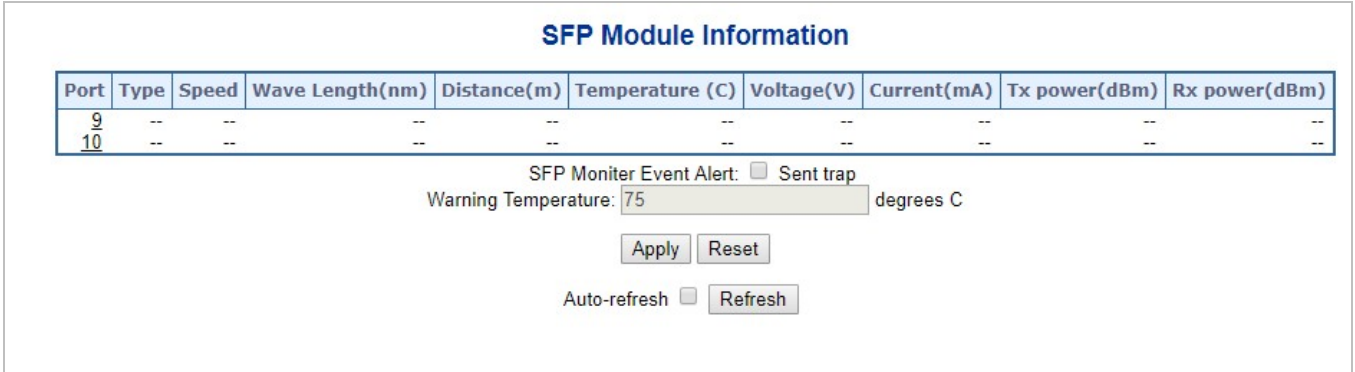

Figure 4-3-1-4: SFP Module Information for Switch Page Screenshot

The page includes the following fields:

| Object | Description |
|--|--|
| <ul style="list-style-type: none"> Type | Display the type of current SFP module; the possible types are: <ul style="list-style-type: none"> ■ 10GBASE-SR ■ 10GBASE-LR ■ 1000BASE-SX ■ 1000BASE-LX ■ 100BASE-FX |
| <ul style="list-style-type: none"> Speed | Display the speed of current SFP module; the speed value or description is got from the SFP module. Different vendors SFP modules might show different speed information. |
| <ul style="list-style-type: none"> Wave Length (nm) | Display the wavelength of current SFP module; the wavelength value is got from the SFP module. Use this column to check if the wavelength values of two nodes are matched while the fiber connection failed. |
| <ul style="list-style-type: none"> Distance (m) | Display the support distance of current SFP module; the distance value is got from the SFP module. |
| <ul style="list-style-type: none"> Temperature (C) - SFP DDM Module Only | Display the temperature of current SFP DDM module; the temperature value is got from the SFP DDM module. |
| <ul style="list-style-type: none"> Voltage(V) - SFP DDM Module Only | Display the voltage of current SFP DDM module; the voltage value is got from the SFP DDM module. |
| <ul style="list-style-type: none"> Current(mA) - SFP DDM Module Only | Display the Ampere of current SFP DDM module; the Ampere value is got from the SFP DDM module. |

| | |
|---|--|
| <ul style="list-style-type: none"> • TX power (dBm) – SFP DDM Module Only | Display the TX power of current SFP DDM module; the TX power value is got from the SFP DDM module. |
| <ul style="list-style-type: none"> • RX power (dBm) – SFP DDM Module Only | Display the RX power of current SFP DDM module; the RX power value is got from the SFP DDM module. |

Buttons

SFP Monitor Event Alert: send trap

Warning Temperature: degrees C

Check SFP Monitor Event Alert box; it will be in accordance with your warning temperature setting and allows users to record message out via SNMP Trap.

Auto-refresh : Check this box to enable an automatic refresh of the page at regular intervals.

: Click to apply changes

: Click to undo any changes made locally and revert to previously saved values.

: Click to refresh the page immediately.

4.3.1.5 Port Mirror

Configure port Mirroring on this page. This function provides monitoring network traffic that forwards a copy of each incoming or outgoing packet from one port of a network Switch to another port where the packet can be studied. It enables the manager to keep close track of switch performance and alter it if necessary.

- To debug network problems, selected traffic can be copied, or mirrored, to a mirror port where a frame analyzer can be attached to analyze the frame flow.
- The **Industrial Managed Switch** can unobtrusively mirror traffic from any port to a monitor port. You can then attach a protocol analyzer or RMON probe to this port to perform traffic analysis and verify connection integrity.

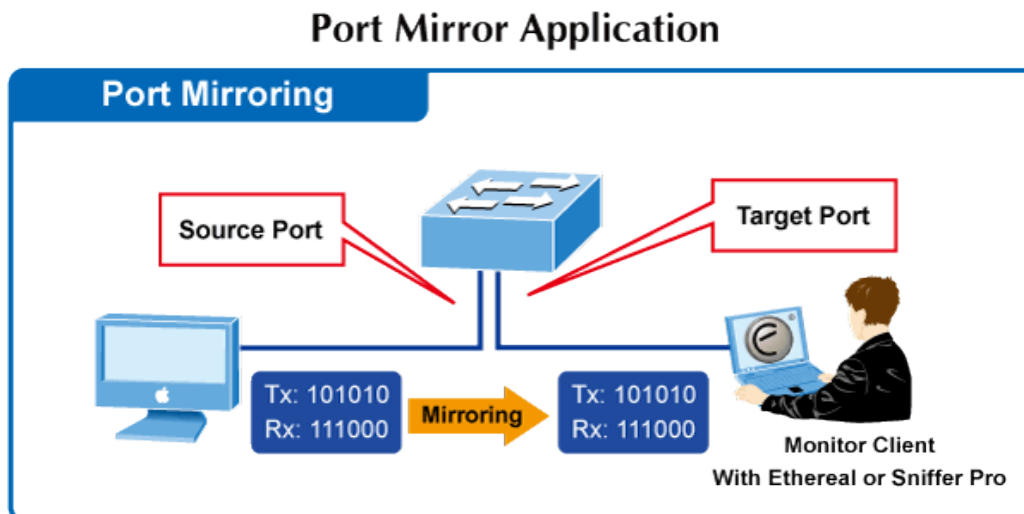

Figure 4-3-1-5: Port Mirror Application

The traffic to be copied to the mirror port is selected as follows:

- All frames received on a given port (also known as ingress or source mirroring).
- All frames transmitted on a given port (also known as egress or destination mirroring).

Mirror Port Configuration

The Port Mirror screen in [Figure 4-3-1-6](#) appears, and click the session ID to [Figure 4-3-1-7](#)

Mirror & RMirror Configuration Table

Refresh

| Session ID | Mode | Type | VLAN ID | Reflector Port |
|------------|----------|--------|---------|----------------|
| 1 | Disabled | Mirror | - | - |
| 2 | Disabled | Mirror | - | - |
| 3 | Disabled | Mirror | - | - |
| ... | ... | ... | ... | ... |

Figure 4-3-1-6: Mirror Configuration Page Screenshot

Mirror & RMirror Configuration

Global Settings

| | |
|---------------|----------|
| Session ID | 1 |
| Mode | Disabled |
| Type | Mirror |
| VLAN ID | 200 |
| ReflectorPort | Port 1 |

Source VLAN(s) Configuration

| | |
|---------|----------------------|
| VLAN ID | <input type="text"/> |
|---------|----------------------|

Port Configuration

| Port | Source | Destination |
|---------|----------|--------------------------|
| * | <All> | <input type="checkbox"/> |
| Port 1 | Disabled | <input type="checkbox"/> |
| Port 2 | Disabled | <input type="checkbox"/> |
| Port 3 | Disabled | <input type="checkbox"/> |
| Port 4 | Disabled | <input type="checkbox"/> |
| Port 5 | Disabled | <input type="checkbox"/> |
| Port 6 | Disabled | <input type="checkbox"/> |
| Port 7 | Disabled | <input type="checkbox"/> |
| Port 8 | Disabled | <input type="checkbox"/> |
| Port 9 | Disabled | <input type="checkbox"/> |
| Port 10 | Disabled | <input type="checkbox"/> |
| CPU | Disabled | <input type="checkbox"/> |

Figure 4-3-1-7: Mirror Configuration Page Screenshot

The page includes the following fields:

| Object | Description |
|--|--|
| <ul style="list-style-type: none"> • Session | <p>Select session id to configure.</p> |
| <ul style="list-style-type: none"> • Mode | <p>To Enabled/Disabled the mirror or Remote Mirroring function</p> |
| <ul style="list-style-type: none"> • Type | <p>Mirror</p> <p>The switch is running on mirror mode. The source port(s) and destination port are located on this switch.</p> <p>Source</p> <p>The switch is a source node for monitor flow. The source port(s), reflector port are located on this switch.</p> <p>RMirror destination</p> <p>The switch is an end node for monitor flow. The destination port(s) is located on this switch.</p> |
| <ul style="list-style-type: none"> • VLAN ID | <p>The VLAN ID points out where the monitor packet will copy to. The default VLAN ID is 200.</p> |
| <ul style="list-style-type: none"> • Reflector Port | <p>The reflector port is a method to redirect the traffic to Remote Mirroring VLAN. Any device connected to a port set as a reflector port loses connectivity until the Remote Mirroring is disabled.</p> <p>In the stacking mode, you need to select switch ID to select the correct device.</p> <p>If you shut down a port, it cannot be a candidate for reflector port.</p> <p>If you shut down the port which is a reflector port, the remote mirror function cannot work</p> |
| <ul style="list-style-type: none"> • Source VLAN(s) Configuration | <p>The switch can supports VLAN-based Mirroring. If you want to monitor some VLANs on the switch, you can set the selected VLANs on this field.</p> |
| <ul style="list-style-type: none"> • Remote Mirroring Port Configuration | <p>The following table is used for port role selecting.</p> <ul style="list-style-type: none"> ■ Port: The logical port for the settings contained in the same row.. ■ Source: Select mirror mode. <ul style="list-style-type: none"> Disabled Neither frames transmitted nor frames received are mirrored. Both Frames received and frames transmitted are mirrored on the Destination port. Rx only Frames received on this port are mirrored on the Destination port. Frames transmitted are not mirrored. Tx only Frames transmitted on this port are mirrored on the Destination port. Frames received are not mirrored ■ Destination: Select destination port. This checkbox is designed for mirror or Remote Mirroring. |





The **destination port** is a switched port that you receive a copy of traffic from the source port.



For a given port, a frame is only transmitted once. It is therefore not possible to mirror Tx frames on the **mirror port**. Because of this, **mode** for the selected mirror port is limited to **Disabled** or **Rx only**.

Buttons

 : Click to apply changes

 : Click to undo any changes made locally and revert to previously saved values.

4.3.2 Link Aggregation

Port Aggregation optimizes port usage by linking a group of ports together to form a single Link Aggregated Groups (LAGs). Port Aggregation multiplies the bandwidth between the devices, increases port flexibility, and provides link redundancy.

Each LAG is composed of ports of the same speed, set to full-duplex operations. Ports in a LAG, can be of different media types (UTP/Fiber, or different fiber types), provided they operate at the same speed.

Aggregated Links can be assigned manually (**Port Trunk**) or automatically by enabling Link Aggregation Control Protocol (**LACP**) on the relevant links.

Aggregated Links are treated by the system as a single logical port. Specifically, the Aggregated Link has similar port attributes to a non-aggregated port, including auto-negotiation, speed, Duplex setting, etc.

The device supports the following Aggregation links :

- **Static LAGs (Port Trunk)** – Force aggregated selected ports to be a trunk group.
- **Link Aggregation Control Protocol (LACP) LAGs** - LACP LAG negotiate Aggregated Port links with other LACP ports located on a different device. If the other device ports are also LACP ports, the devices establish a LAG between them.

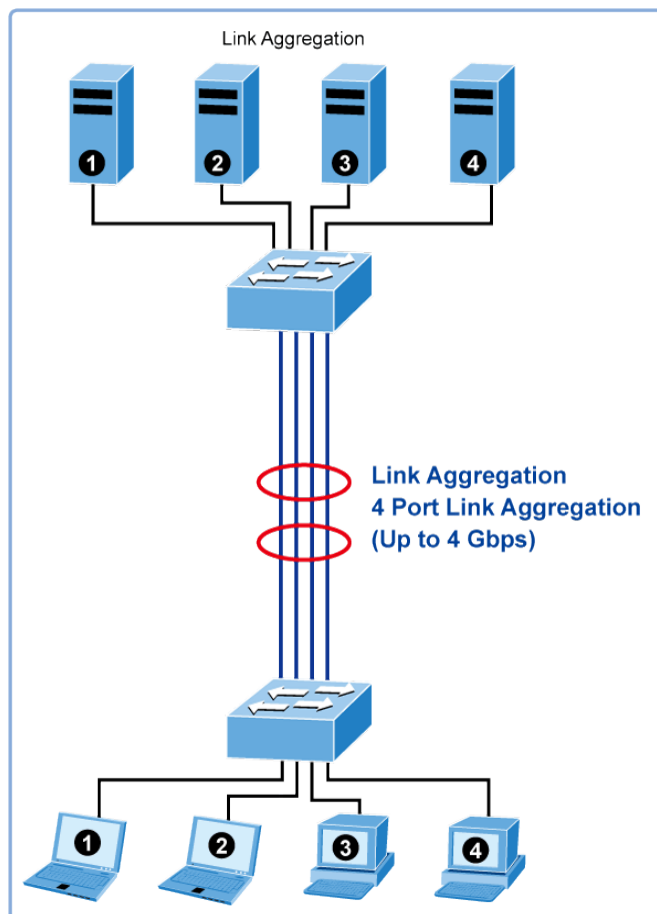

Figure 4-3-2-1: Link Aggregation

The **Link Aggregation Control Protocol (LACP)** provides a standardized means for exchanging information between Partner Systems that require high speed redundant links. Link aggregation lets you group up to eight consecutive ports into a single dedicated connection. This feature can expand bandwidth to a device on the network. LACP operation requires full-duplex mode, more detail information refer to the IEEE 802.3ad standard.

Port link aggregations can be used to increase the bandwidth of a network connection or to ensure fault recovery. Link aggregation lets you group up to 4 consecutive ports into a single dedicated connection between any two the Switch or other Layer 2 switches. However, before making any physical connections between devices, use the Link aggregation Configuration menu to specify the link aggregation on the devices at both ends. When using a port link aggregation, note that:

- The ports used in a link aggregation must all be of the same media type (RJ45, 100 Mbps fiber).
- The ports that can be assigned to the same link aggregation have certain other restrictions (see below).
- Ports can only be assigned to one link aggregation.
- The ports at both ends of a connection must be configured as link aggregation ports.
- None of the ports in a link aggregation can be configured as a mirror source port or a mirror target port.
- All of the ports in a link aggregation have to be treated as a whole when moved from/to, added or deleted from a VLAN.
- The Spanning Tree Protocol will treat all the ports in a link aggregation as a whole.
- Enable the link aggregation prior to connecting any cable between the switches to avoid creating a data loop.
- Disconnect all link aggregation port cables or disable the link aggregation ports before removing a port link aggregation to avoid creating a data loop.

It allows a maximum of 10 ports to be aggregated at the same time. The **Industrial Managed Switch** support Gigabit Ethernet ports (up to 5 groups). If the group is defined as a LACP static link aggregation group, then any extra ports selected are placed in a standby mode for redundancy if one of the other ports fails. If the group is defined as a local static link aggregation group, then the number of ports must be the same as the group member ports.

The aggregation code ensures that frames belonging to the same frame flow (for example, a TCP connection) are always forwarded on the same link aggregation member port. Recording of frames within a flow is therefore not possible. The aggregation code is based on the following information:

- **Source MAC**
- **Destination MAC**
- **Source and destination IPv4 address.**
- **Source and destination TCP/UDP ports for IPv4 packets**

Normally, all 5 contributions to the aggregation code should be enabled to obtain the best traffic distribution among the link aggregation member ports. Each link aggregation may consist of up to 10 member ports. Any quantity of link aggregation s may be configured for the device (only limited by the quantity of ports on the device.) To configure a proper traffic distribution, the ports within a link aggregation must use the same link speed.

4.3.2.1 Static Aggregation

This page is used to configure the Aggregation hash mode and the aggregation group. The aggregation hash mode settings are global.

Hash Code Contributors

The Static Aggregation screen in [Figure 4-3-2-2](#) appears.

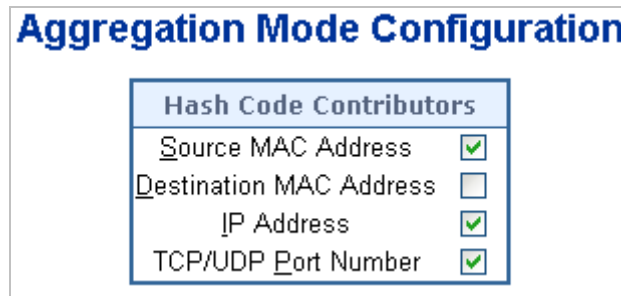

Figure 4-3-2-2 : Aggregation Mode Configuration Page Screenshot

The page includes the following fields:

| Object | Description |
|--|--|
| <ul style="list-style-type: none"> • Source MAC Address | The Source MAC address can be used to calculate the destination port for the frame. Check to enable the use of the Source MAC address, or uncheck to disable. By default, Source MAC Address is enabled. |
| <ul style="list-style-type: none"> • Destination MAC Address | The Destination MAC Address can be used to calculate the destination port for the frame. Check to enable the use of the Destination MAC Address, or uncheck to disable. By default, Destination MAC Address is disabled. |
| <ul style="list-style-type: none"> • IP Address | The IP address can be used to calculate the destination port for the frame. Check to enable the use of the IP Address, or uncheck to disable. By default, IP Address is enabled. |
| <ul style="list-style-type: none"> • TCP/UDP Port Number | The TCP/UDP port number can be used to calculate the destination port for the frame. Check to enable the use of the TCP/UDP Port Number, or uncheck to disable. By default, TCP/UDP Port Number is enabled. |

Static Aggregation Group Configuration

The Aggregation Group Configuration screen in [Figure 4-3-2-3](#) appears.

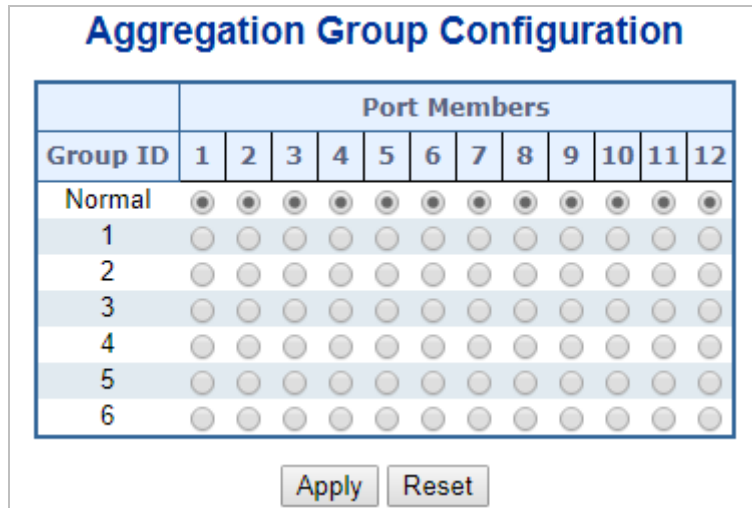

Figure 4-3-2-3: Aggregation Group Configuration Page Screenshot

The page includes the following fields:

| .Object | Description |
|---|---|
| <ul style="list-style-type: none"> Group ID | Indicates the group ID for the settings contained in the same row. Group ID "Normal" indicates there is no aggregation. Only one group ID is valid per port. |
| <ul style="list-style-type: none"> Port Members | Each switch port is listed for each group ID. Select a radio button to include a port in an aggregation, or clear the radio button to remove the port from the aggregation. By default, no ports belong to any aggregation group. |

Buttons

: Click to apply changes

: Click to undo any changes made locally and revert to previously saved values.

4.3.2.2 Static Aggregation Status

This page is used to see the status of ports in Aggregation group. The Static Aggregation Status screen in [Figure 4-3-2-4](#) appears.

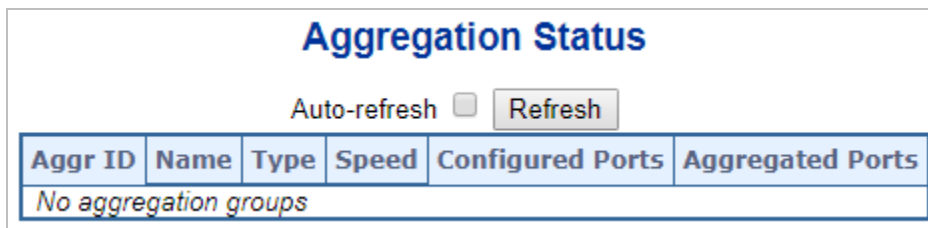



Figure 4-3-2-4 : LACP Port Configuration Page Screenshot

The page includes the following fields:

| Object | Description |
|---------------------------|---|
| • Aggr ID | Display the Aggregation ID associated with this aggregation instance. |
| • Name | Display the Name of the Aggregation group ID. |
| • Type | Display the type of the Aggregation group(Static or LACP). |
| • Speed | Display the Speed of the Aggregation group. |
| • Configured Ports | Display the Configured member ports of the Aggregation group. |
| • Aggregated Ports | Display the Aggregated member ports of the Aggregation group. |

Buttons

: Click to refresh the page immediately.

Auto-refresh Automatic refresh occurs every 3 seconds.

4.3.2.3 LACP Configuration

Link Aggregation Control Protocol (LACP) - LACP LAG negotiate Aggregated Port links with other LACP ports located on a different device. LACP allows switches connected to each other to discover automatically whether any ports are member of the same LAG.

This page allows the user to inspect the current LACP port configurations, and possibly change them as well. The LACP Configuration screen in [Figure 4-3-2-5](#) appears.

LACP System Configuration

System Priority

LACP Port Configuration

| Port | LACP Enabled | Key | | Role | Timeout | Priority |
|------|--------------------------|---------|----------------------|----------|---------|----------|
| * | <input type="checkbox"/> | <All> ▼ | <input type="text"/> | <All> ▼ | <All> ▼ | 32768 |
| 1 | <input type="checkbox"/> | Auto ▼ | <input type="text"/> | Active ▼ | Fast ▼ | 32768 |
| 2 | <input type="checkbox"/> | Auto ▼ | <input type="text"/> | Active ▼ | Fast ▼ | 32768 |
| 3 | <input type="checkbox"/> | Auto ▼ | <input type="text"/> | Active ▼ | Fast ▼ | 32768 |
| 4 | <input type="checkbox"/> | Auto ▼ | <input type="text"/> | Active ▼ | Fast ▼ | 32768 |
| 5 | <input type="checkbox"/> | Auto ▼ | <input type="text"/> | Active ▼ | Fast ▼ | 32768 |
| 6 | <input type="checkbox"/> | Auto ▼ | <input type="text"/> | Active ▼ | Fast ▼ | 32768 |
| 7 | <input type="checkbox"/> | Auto ▼ | <input type="text"/> | Active ▼ | Fast ▼ | 32768 |
| 8 | <input type="checkbox"/> | Auto ▼ | <input type="text"/> | Active ▼ | Fast ▼ | 32768 |
| 9 | <input type="checkbox"/> | Auto ▼ | <input type="text"/> | Active ▼ | Fast ▼ | 32768 |
| 10 | <input type="checkbox"/> | Auto ▼ | <input type="text"/> | Active ▼ | Fast ▼ | 32768 |
| 11 | <input type="checkbox"/> | Auto ▼ | <input type="text"/> | Active ▼ | Fast ▼ | 32768 |
| 12 | <input type="checkbox"/> | Auto ▼ | <input type="text"/> | Active ▼ | Fast ▼ | 32768 |

Figure 4-3-2-5 : LACP Port Configuration Page Screenshot

The page includes the following fields:

| Object | Description |
|-----------------------|--|
| • Port | The switch port number. |
| • LACP Enabled | Controls whether LACP is enabled on this switch port. LACP will form an aggregation when 2 or more ports are connected to the same partner. |
| • Key | The Key value incurred by the port, range 1-65535 . The Auto setting will set the key as appropriate by the physical link speed, 10Mb = 1, 100Mb = 2, 1Gb = 3. Using the Specific setting, a user-defined value can be entered. Ports with the same Key value can participate in the same aggregation group, while ports with different keys cannot. The default setting is “Auto” |
| • Role | The Role shows the LACP activity status. The Active will transmit LACP packets each second, while Passive will wait for a LACP packet from a partner (speak if spoken to). |
| • Timeout | The Timeout controls the period between BPDU transmissions. Fast will transmit |

| | |
|---|--|
| | LACP packets each second, while Slow will wait for 30 seconds before sending a LACP packet. |
| <ul style="list-style-type: none"> • Priority | The Priority controls the priority of the port. If the LACP partner wants to form a larger group than is supported by this device then this parameter will control which ports will be active and which ports will be in a backup role. Lower number means greater priority. |

Buttons

: Click to apply changes

: Click to undo any changes made locally and revert to previously saved values.

4.3.2.4 LACP System Status

This page provides a status overview of all LACP instances. The LACP Status Page display the current LACP aggregation Groups and LACP Port status. The LACP System Status screen in [Figure 4-3-2-6](#) appears.

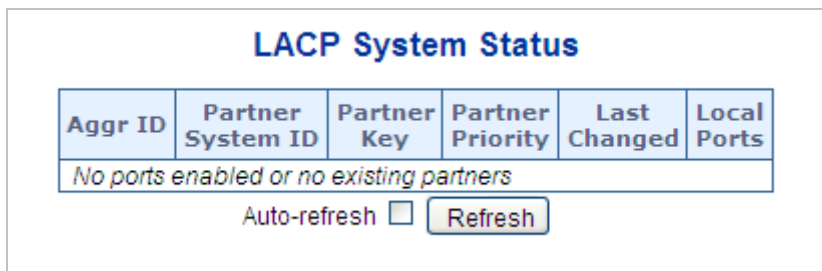

Figure 4-3-2-6: LACP System Status Page Screenshot

The page includes the following fields:

| Object | Description |
|--|--|
| <ul style="list-style-type: none"> • Aggr ID | The Aggregation ID associated with this aggregation instance. For LLAG the id is shown as 'isid:aggr-id' and for GLAGs as 'aggr-id' |
| <ul style="list-style-type: none"> • Partner System ID | The system ID (MAC address) of the aggregation partner. |
| <ul style="list-style-type: none"> • Partner Key | The Key that the partner has assigned to this aggregation ID. |
| <ul style="list-style-type: none"> • Partner Priority | The priority of the aggregation partner. |
| <ul style="list-style-type: none"> • Last Changed | The time since this aggregation changed. |
| <ul style="list-style-type: none"> • Local Ports | Shows which ports are a part of this aggregation for this switch. |

Buttons

: Click to refresh the page immediately.

Auto-refresh Automatic refresh occurs every 3 seconds.

4.3.2.5 LACP Port Status

This page provides a status overview of LACP status for all ports. The LACP Port Status screen in [Figure 4-5-2-7](#) appears.

| LACP Status | | | | | | |
|-------------|------|-----|---------|-------------------|--------------|------------------|
| Port | LACP | Key | Aggr ID | Partner System ID | Partner Port | Partner Priority |
| 1 | No | - | - | - | - | - |
| 2 | No | - | - | - | - | - |
| 3 | No | - | - | - | - | - |
| 4 | No | - | - | - | - | - |
| 5 | No | - | - | - | - | - |
| 6 | No | - | - | - | - | - |
| 7 | No | - | - | - | - | - |
| 8 | No | - | - | - | - | - |
| 9 | No | - | - | - | - | - |
| 10 | No | - | - | - | - | - |
| 11 | No | - | - | - | - | - |
| 12 | No | - | - | - | - | - |

Auto-refresh

Figure 4-3-2-7: LACP Status Page Screenshot

The page includes the following fields:

| Object | Description |
|----------------------------|--|
| • Port | The switch port number. |
| • LACP | 'Yes' means that LACP is enabled and the port link is up. 'No' means that LACP is not enabled or that the port link is down. 'Backup' means that the port could not join the aggregation group but will join if other port leaves. Meanwhile it's LACP status is disabled. |
| • Key | The key assigned to this port. Only ports with the same key can aggregate together. |
| • Aggr ID | The Aggregation ID assigned to this aggregation group. |
| • Partner System ID | The partner's System ID (MAC address). |
| • Partner Port | The partner's port number connected to this port. |
| • Partner Priority | The partner's port priority. |

Buttons

: Click to refresh the page immediately.

Auto-refresh : Automatic refresh occurs every 3 seconds.

4.3.2.6 LACP Port Statistics

This page provides an overview for LACP statistics for all ports. The LACP Port Status screen in [Figure 4-5-2-8](#) appears.

| Port | LACP Received | LACP Transmitted | Discarded | |
|------|---------------|------------------|-----------|---------|
| | | | Unknown | Illegal |
| 1 | 0 | 0 | 0 | 0 |
| 2 | 0 | 0 | 0 | 0 |
| 3 | 0 | 0 | 0 | 0 |
| 4 | 0 | 0 | 0 | 0 |
| 5 | 0 | 0 | 0 | 0 |
| 6 | 0 | 0 | 0 | 0 |
| 7 | 0 | 0 | 0 | 0 |
| 8 | 0 | 0 | 0 | 0 |
| 9 | 0 | 0 | 0 | 0 |
| 10 | 0 | 0 | 0 | 0 |
| 11 | 0 | 0 | 0 | 0 |
| 12 | 0 | 0 | 0 | 0 |

Auto-refresh

Figure 4-3-2-8: LACP Port Statistics Page Screenshot

The page includes the following fields:

| Object | Description |
|---------------------------|---|
| • Port | The switch port number. |
| • LACP Received | Shows how many LACP frames have been received at each port. |
| • LACP Transmitted | Shows how many LACP frames have been sent from each port. |
| • Discarded | Shows how many unknown or illegal LACP frames have been discarded at each port. |

Buttons

: Click to refresh the page immediately.

Auto-refresh : Automatic refresh occurs every 3 seconds.

: Clears the counters for all ports.

4.3.3 VLAN

4.3.3.1 VLAN Overview

A **Virtual Local Area Network (VLAN)** is a network topology configured according to a logical scheme rather than the physical layout. VLAN can be used to combine any collection of LAN segments into an autonomous user group that appears as a single LAN. VLAN also logically segment the network into different broadcast domains so that packets are forwarded only between ports within the VLAN. Typically, a VLAN corresponds to a particular subnet, although not necessarily.

VLAN can enhance performance by conserving bandwidth, and improve security by limiting traffic to specific domains.

A VLAN is a collection of end nodes grouped by logic instead of physical location. End nodes that frequently communicate with each other are assigned to the same VLAN, regardless of where they are physically on the network. Logically, a VLAN can be equated to a broadcast domain, because broadcast packets are forwarded to only members of the VLAN on which the broadcast was initiated.



-
1. No matter what basis is used to uniquely identify end nodes and assign these nodes VLAN membership, packets cannot cross VLAN without a network device performing a routing function between the VLANs.
 2. The **Industrial Managed Switch** supports IEEE 802.1Q VLAN. The port untagging function can be used to remove the 802.1 tag from packet headers to maintain compatibility with devices that are tag-unaware..
-



The **Industrial Managed Switch** 's default is to assign all ports to a single 802.1Q VLAN named DEFAULT_VLAN. As new VLAN is created, the member ports assigned to the new VLAN will be removed from the DEFAULT_ VLAN port member list. The DEFAULT_VLAN has a VID = 1.

This section has the following items:

- **VLAN Port Configuration** Enables VLAN group
- **VLAN Membership Status** Displays VLAN membership status
- **VLAN Port Status** Displays VLAN port status
- **Private VLAN** Creates/removes primary or community VLANs
- **Port Isolation** Enables/disable port isolation on port
- **MAC-based VLAN** Configures the MAC-based VLAN entries
- **MAC-based VLAN Status** Displays MAC-based VLAN entries
- **Protocol-based VLAN** Configures the protocol-based VLAN entries
- **Protocol-based VLAN Membership** Displays the protocol-based VLAN entries

4.3.3.2 IEEE 802.1Q VLAN

In large networks, routers are used to isolate broadcast traffic for each subnet into separate domains. This **Industrial Managed Switch** provides a similar service at Layer 2 by using VLANs to organize any group of network nodes into separate broadcast domains. VLANs confine broadcast traffic to the originating group, and can eliminate broadcast storms in large networks. This also provides a more secure and cleaner network environment.

An IEEE 802.1Q VLAN is a group of ports that can be located anywhere in the network, but communicate as though they belong to the same physical segment.

VLANs help to simplify network management by allowing you to move devices to a new VLAN without having to change any physical connections. VLANs can be easily organized to reflect departmental groups (such as Marketing or R&D), usage groups (such as e-mail), or multicast groups (used for multimedia applications such as videoconferencing).

VLANs provide greater network efficiency by reducing broadcast traffic, and allow you to make network changes without having to update IP addresses or IP subnets. VLANs inherently provide a high level of network security since traffic must pass through a configured Layer 3 link to reach a different VLAN.

This **Industrial Managed Switch** supports the following VLAN features:

- Up to 255 VLANs based on the IEEE 802.1Q standard
- Port overlapping, allowing a port to participate in multiple VLANs
- End stations can belong to multiple VLANs
- Passing traffic between VLAN-aware and VLAN-unaware devices
- Priority tagging

■ IEEE 802.1Q Standard

IEEE 802.1Q (tagged) VLAN are implemented on the Switch. 802.1Q VLAN require tagging, which enables them to span the entire network (assuming all switches on the network are IEEE 802.1Q-compliant).

VLAN allow a network to be segmented in order to reduce the size of broadcast domains. All packets entering a VLAN will only be forwarded to the stations (over IEEE 802.1Q enabled switches) that are members of that VLAN, and this includes broadcast, multicast and unicast packets from unknown sources.

VLAN can also provide a level of security to your network. IEEE 802.1Q VLAN will only deliver packets between stations that are members of the VLAN. Any port can be configured as either **tagging** or **untagging**.

- The untagging feature of IEEE 802.1Q VLAN allows VLAN to work with legacy switches that don't recognize VLAN tags in packet headers.
- The tagging feature allows VLAN to span multiple 802.1Q-compliant switches through a single physical connection and allows Spanning Tree to be enabled on all ports and work normally.

Some relevant terms:

- **Tagging** - The act of putting 802.1Q VLAN information into the header of a packet.
- **Untagging** - The act of stripping 802.1Q VLAN information out of the packet header.

802.1Q VLAN Tags

The figure below shows the 802.1Q VLAN tag. There are four additional octets inserted after the source MAC address. Their presence is indicated by a value of **0x8100** in the Ether Type field. When a packet's Ether Type field is equal to 0x8100, the packet carries the IEEE 802.1Q/802.1p tag. The tag is contained in the following two octets and consists of 3 bits of user priority, 1 bit of Canonical Format Identifier (CFI - used for encapsulating Token Ring packets so they can be carried across Ethernet backbones), and 12 bits of **VLAN ID (VID)**. The 3 bits of user priority are used by 802.1p. The VID is the VLAN identifier and is used by the 802.1Q standard. Because the VID is 12 bits long, 4094 unique VLAN can be identified.

The tag is inserted into the packet header making the entire packet longer by 4 octets. All of the information originally contained in the packet is retained.

802.1Q Tag

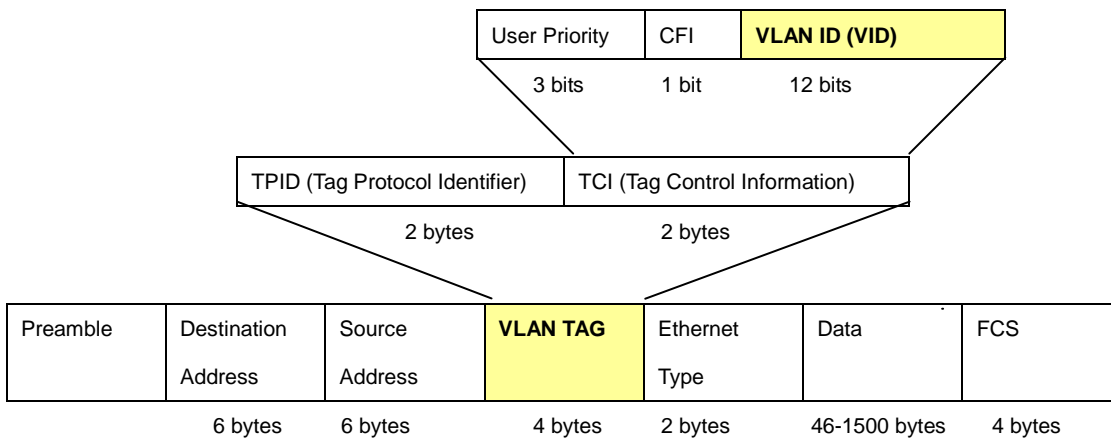

The Ether Type and VLAN ID are inserted after the MAC source address, but before the original Ether Type/Length or Logical Link Control. Because the packet is now a bit longer than it was originally, the Cyclic Redundancy Check (CRC) must be recalculated.

Adding an IEEE802.1Q Tag

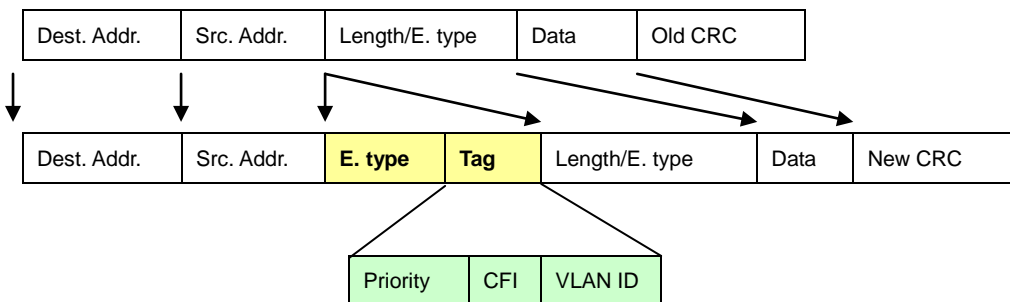

Port VLAN ID

Packets that are tagged (are carrying the 802.1Q VID information) can be transmitted from one 802.1Q compliant network device to another with the VLAN information intact. This allows 802.1Q VLAN to span network devices (and indeed, the entire network – if all network devices are 802.1Q compliant).

Every physical port on a switch has a PVID. 802.1Q ports are also assigned a PVID, for use within the switch. If no VLAN are defined on the switch, all ports are then assigned to a default VLAN with a PVID equal to 1. Untagged packets are assigned the PVID of the port on which they were received. Forwarding decisions are based upon this PVID, in so far as VLAN are concerned. Tagged packets are forwarded according to the VID contained within the tag. Tagged packets are also assigned a PVID, but the PVID is not used to make packet forwarding decisions, the VID is.

Tag-aware switches must keep a table to relate PVID within the switch to VID on the network. The switch will compare the VID of a packet to be transmitted to the VID of the port that is to transmit the packet. If the two VID are different the switch will drop the packet. Because of the existence of the PVID for untagged packets and the VID for tagged packets, tag-aware and tag-unaware network devices can coexist on the same network.

A switch port can have only one PVID, but can have as many VID as the switch has memory in its VLAN table to store them.

Because some devices on a network may be tag-unaware, a decision must be made at each port on a tag-aware device before packets are transmitted – should the packet to be transmitted have a tag or not? If the transmitting port is connected to a tag-unaware device, the packet should be untagged. If the transmitting port is connected to a tag-aware device, the packet should be tagged.

■ Default VLANs

The Switch initially configures one VLAN, VID = 1, called "**default**." The factory default setting assigns all ports on the Switch to the "**default**". As new VLAN are configured in Port-based mode, their respective member ports are removed from the "**default**".

■ Assigning Ports to VLANs

Before enabling VLANs for the switch, you must first assign each port to the VLAN group(s) in which it will participate. By default all ports are assigned to VLAN 1 as untagged ports. Add a port as a tagged port if you want it to carry traffic for one or more VLANs, and any intermediate network devices or the host at the other end of the connection supports VLANs. Then assign ports on the other VLAN-aware network devices along the path that will carry this traffic to the same VLAN(s), either manually or dynamically using GVRP. However, if you want a port on this switch to participate in one or more VLANs, but none of the intermediate network devices nor the host at the other end of the connection supports VLANs, then you should add this port to the VLAN as an untagged port.

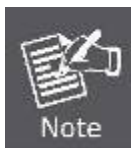

VLAN-tagged frames can pass through VLAN-aware or VLAN-unaware network interconnection devices, but the VLAN tags should be stripped off before passing it on to any end-node host that does not support VLAN tagging.

■ VLAN Classification

When the switch receives a frame, it classifies the frame in one of two ways. If the frame is untagged, the switch assigns the frame to an associated VLAN (based on the default VLAN ID of the receiving port). But if the frame is tagged, the switch uses the tagged VLAN ID to identify the port broadcast domain of the frame.

■ Port Overlapping

Port overlapping can be used to allow access to commonly shared network resources among different VLAN groups, such as file servers or printers. Note that if you implement VLANs which do not overlap, but still need to communicate, you can connect them by enabled routing on this switch.

■ Untagged VLANs

Untagged (or static) VLANs are typically used to reduce broadcast traffic and to increase security. A group of network users assigned to a VLAN form a broadcast domain that is separate from other VLANs configured on the switch. Packets are forwarded only between ports that are designated for the same VLAN. Untagged VLANs can be used to manually isolate user groups or subnets.

4.3.3.3 VLAN Port Configuration

This page is used for configuring the **Industrial Managed Switch** port VLAN. The VLAN per Port Configuration page contains fields for managing ports that are part of a VLAN. The port default VLAN ID (PVID) is configured on the VLAN Port Configuration page. All untagged packets arriving to the device are tagged by the ports PVID.

Understand nomenclature of the Switch

■ IEEE 802.1Q Tagged and Untagged

Every port on an 802.1Q compliant switch can be configured as tagged or untagged.

- **Tagged:** Ports with tagging enabled will put the VID number, priority and other VLAN information into the header of all packets that flow into those ports. If a packet has previously been tagged, the port will not alter the packet, thus keeping the VLAN information intact. The VLAN information in the tag can then be used by other 802.1Q compliant devices on the network to make packet-forwarding decisions.
- **Untagged:** Ports with untagging enabled will strip the 802.1Q tag from all packets that flow into those ports. If the packet doesn't have an 802.1Q VLAN tag, the port will not alter the packet. Thus, all packets received by and forwarded by an untagging port will have no 802.1Q VLAN information. (Remember that the PVID is only used internally within the Switch). Untagging is used to send packets from an 802.1Q-compliant network device to a non-compliant network device.

| Frame Income / Frame Leave | Income Frame is tagged | Income Frame is untagged |
|----------------------------|-------------------------------|---------------------------------|
| Leave port is tagged | Frame remains tagged | Tag is inserted |
| Leave port is untagged | Tag is removed | Frame remain untagged |

Table 4-3-3-1: Ingress / Egress Port with VLAN VID Tag / Untag Table

■ IEEE 802.1Q Tunneling (Q-in-Q)

IEEE 802.1Q Tunneling (Q-in-Q) is designed for service providers carrying traffic for multiple customers across their networks. Q-in-Q tunneling is used to maintain customer-specific VLAN and Layer 2 protocol configurations even when different customers use the same internal VLAN IDs. This is accomplished by inserting **Service Provider VLAN (SPVLAN)** tags into the customer's frames when they enter the service provider's network, and then stripping the tags when the frames leave the network.

A service provider's customers may have specific requirements for their internal VLAN IDs and number of VLANs supported. VLAN ranges required by different customers in the same service-provider network might easily overlap, and traffic passing through the infrastructure might be mixed. Assigning a unique range of VLAN IDs to each customer would restrict customer configurations, require intensive processing of VLAN mapping tables, and could easily exceed the maximum VLAN limit of 4096.

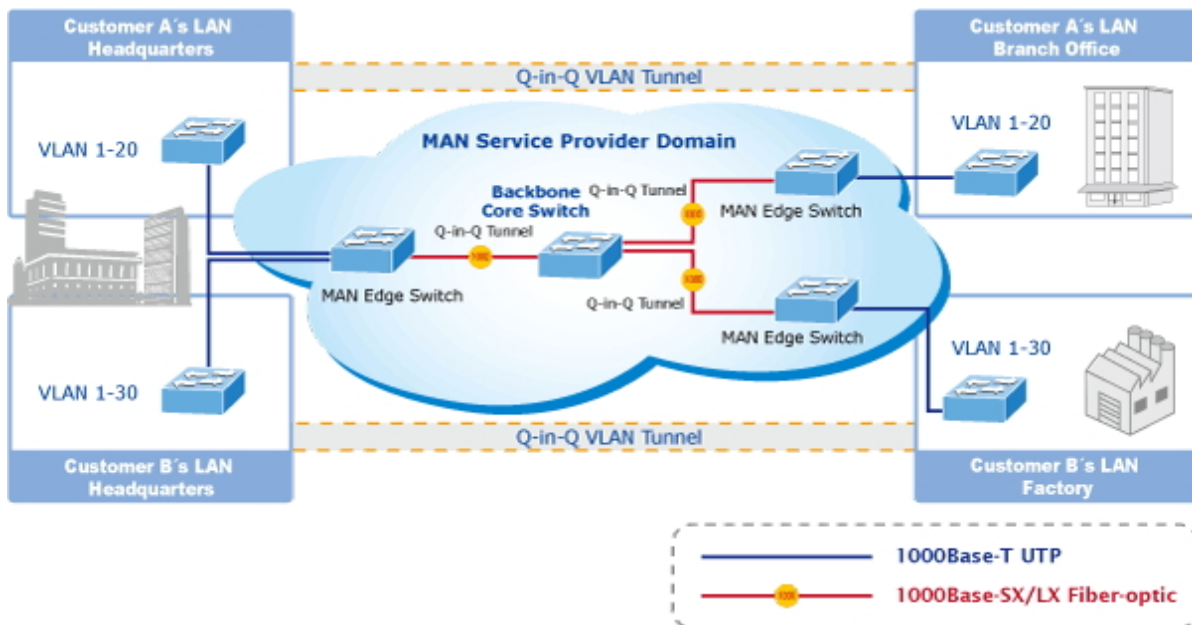

The **Industrial Managed Switch** supports multiple VLAN tags and can therefore be used in MAN applications as a provider bridge, aggregating traffic from numerous independent customer LANs into the **MAN (Metro Access Network)** space. One of the purposes of the provider bridge is to recognize and use VLAN tags so that the VLANs in the MAN space can be used independent of the customers' VLANs. This is accomplished by adding a VLAN tag with a MAN-related VID for frames entering the MAN. When leaving the MAN, the tag is stripped and the original VLAN tag with the customer-related VID is again available.

This provides a tunneling mechanism to connect remote customer VLANs through a common MAN space without interfering with the VLAN tags. All tags use EtherType **0x8100** or **0x88A8**, where 0x8100 is used for customer tags and 0x88A8 are used for service provider tags.

In cases where a given service VLAN only has two member ports on the switch, the learning can be disabled for the particular VLAN and can therefore rely on flooding as the forwarding mechanism between the two ports. This way, the MAC table requirements is reduced.

Global VLAN Configuration

The Global VLAN Configuration screen in [Figure 4-3-3-1](#) appears.

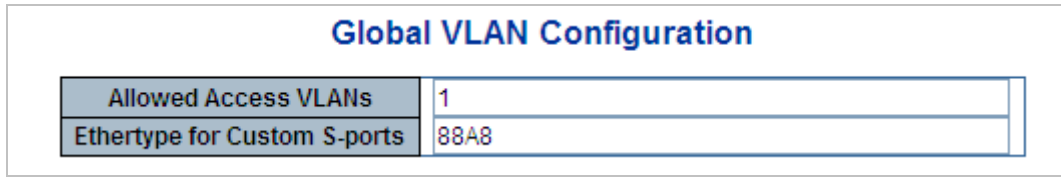

Figure 4-3-3-1 : Global VLAN Configuration Screenshot

The page includes the following fields:

| Object | Description |
|---|---|
| <ul style="list-style-type: none"> Allowed Access VLANs | <p>This field shows the allowed Access VLANs, it only affects ports configured as Access ports. Ports in other modes are members of all VLANs specified in the Allowed VLANs field.</p> <p>By default, only VLAN 1 is enabled. More VLANs may be created by using a list syntax where the individual elements are separated by commas. Ranges are specified with a dash separating the lower and upper bound.</p> <p>The following example will create VLANs 1, 10, 11, 12, 13, 200, and 300: 1, 10-13, 200, 300. Spaces are allowed in between the delimiters.</p> |
| <ul style="list-style-type: none"> Ethertype for Custom S-ports | <p>This field specifies the ethertype/TPID (specified in hexadecimal) used for Custom S-ports. The setting is in force for all ports whose Port Type is set to S-Custom-Port.</p> |

Port VLAN Configuration

The VLAN Port Configuration screen in [Figure 4-3-3-2](#) appears.

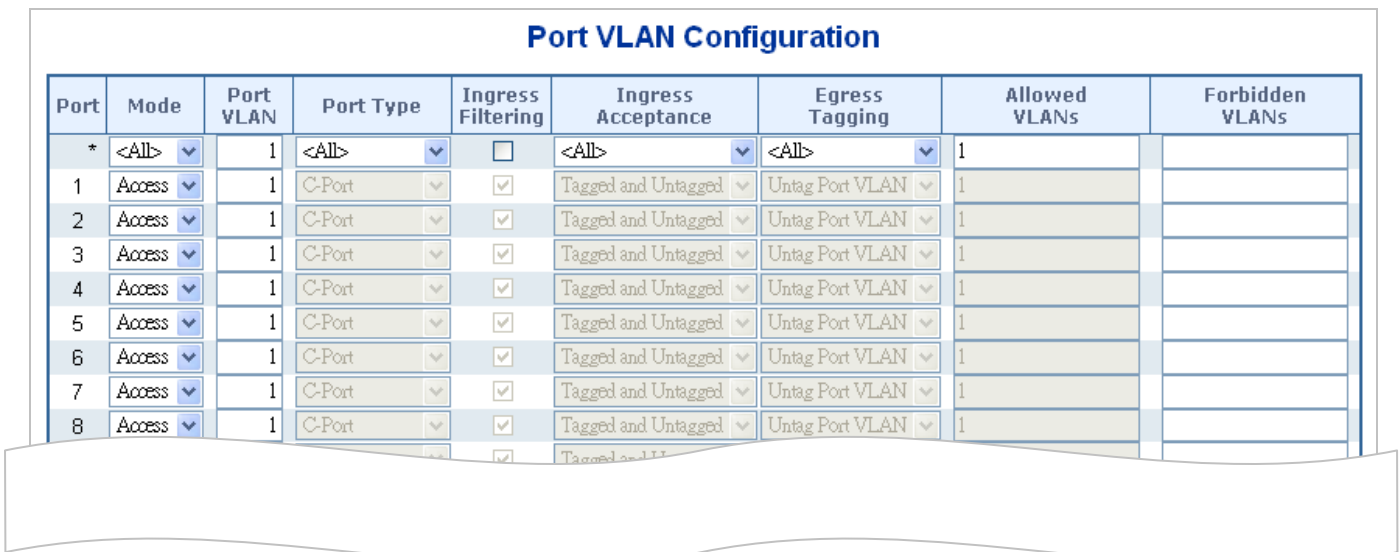

Figure 4-3-3-2 : Port VLAN Configuration Screenshot

The page includes the following fields:

| Object | | Description |
|-------------|--------|--|
| • Port | | This is the logical port number for this row. |
| • Mode | Access | <p>Access ports are normally used to connect to end stations. Dynamic features like Voice VLAN may add the port to more VLANs behind the scenes. Access ports have the following characteristics:</p> <ul style="list-style-type: none"> • Member of exactly one VLAN, the Port VLAN (Access VLAN), which by default is 1 • Accepts untagged and C-tagged frames • Discards all frames that are not classified to the Access VLAN • On egress all frames classified to the Access VLAN are transmitted untagged. Other (dynamically added VLANs) are transmitted tagged |
| | Trunk | <p>Trunk ports can carry traffic on multiple VLANs simultaneously, and are normally used to connect to other switches. Trunk ports have the following characteristics:</p> <ul style="list-style-type: none"> • By default, a trunk port is member of all VLANs (1-4095) • The VLANs that a trunk port is member of may be limited by the use of Allowed VLANs • Frames classified to a VLAN that the port is not a member of are discarded • By default, all frames but frames classified to the Port VLAN (a.k.a. Native VLAN) get tagged on egress. Frames classified to the Port VLAN do not get C-tagged on egress • Egress tagging can be changed to tag all frames, in which case only tagged frames are accepted on ingress |
| | Hybrid | <p>Hybrid ports resemble trunk ports in many ways, but adds additional port configuration features. In addition to the characteristics described for trunk ports, hybrid ports have these abilities:</p> <ul style="list-style-type: none"> • Can be configured to be VLAN tag unaware, C-tag aware, S-tag aware, or S-custom-tag aware • Ingress filtering can be controlled • Ingress acceptance of frames and configuration of egress tagging can be configured independently |
| • Port VLAN | | <p>Determines the port's VLAN ID (PVID). Allowed VLANs are in the range 1 through 4095, default being 1.</p> <ul style="list-style-type: none"> ■ On ingress, frames get classified to the Port VLAN if the port is configured as VLAN unaware, the frame is untagged, or VLAN awareness is enabled on the port, but the frame is priority tagged (VLAN ID = 0). ■ On egress, frames classified to the Port VLAN do not get tagged if Egress |

| | |
|---|--|
| | <p>Tagging configuration is set to untag Port VLAN.</p> <p>The Port VLAN is called an "Access VLAN" for ports in Access mode and Native VLAN for ports in Trunk or Hybrid mode.</p> |
| <ul style="list-style-type: none"> • Port Type | <p>Ports in hybrid mode allow for changing the port type, that is, whether a frame's VLAN tag is used to classify the frame on ingress to a particular VLAN, and if so, which TPID it reacts on. Likewise, on egress, the Port Type determines the TPID of the tag, if a tag is required.</p> <ul style="list-style-type: none"> ■ <u>Unaware:</u> On ingress, all frames, whether carrying a VLAN tag or not, get classified to the Port VLAN, and possible tags are not removed on egress. ■ <u>C-Port:</u> On ingress, frames with a VLAN tag with TPID = 0x8100 get classified to the VLAN ID embedded in the tag. If a frame is untagged or priority tagged, the frame gets classified to the Port VLAN. If frames must be tagged on egress, they will be tagged with a C-tag. ■ <u>S-Port:</u> On ingress, frames with a VLAN tag with TPID = 0x8100 or 0x88A8 get classified to the VLAN ID embedded in the tag. If a frame is untagged or priority tagged, the frame gets classified to the Port VLAN. If frames must be tagged on egress, they will be tagged with an S-tag. ■ <u>S-Custom-Port:</u> On ingress, frames with a VLAN tag with a TPID = 0x8100 or equal to the Ethertype configured for Custom-S ports get classified to the VLAN ID embedded in the tag. If a frame is untagged or priority tagged, the frame gets classified to the Port VLAN. If frames must be tagged on egress, they will be tagged with the custom S-tag. |
| <ul style="list-style-type: none"> • Ingress Filtering | <p>Hybrid ports allow for changing ingress filtering. Access and Trunk ports always have ingress filtering enabled.</p> <ul style="list-style-type: none"> ■ If ingress filtering is enabled (checkbox is checked), frames classified to a VLAN that the port is not a member of get discarded. ■ If ingress filtering is disabled, frames classified to a VLAN that the port is not a member of are accepted and forwarded to the switch engine. <p>However, the port will never transmit frames classified to VLANs that it is not a member of.</p> |
| <ul style="list-style-type: none"> • Ingress Acceptance | <p>Hybrid ports allow for changing the type of frames that are accepted on ingress.</p> <ul style="list-style-type: none"> ■ <u>Tagged and Untagged</u> Both tagged and untagged frames are accepted. ■ <u>Tagged Only</u> Only tagged frames are accepted on ingress. Untagged frames are |

| | |
|--|--|
| | <p>discarded.</p> <ul style="list-style-type: none"> ■ Untagged Only <p>Only untagged frames are accepted on ingress. Tagged frames are discarded.</p> |
| <p>Egress Tagging</p> | <p>This option is only available for ports in Hybrid mode. Ports in Trunk and Hybrid mode may control the tagging of frames on egress.</p> <ul style="list-style-type: none"> ■ Untag Port VLAN <p>Frames classified to the Port VLAN are transmitted untagged. Other frames are transmitted with the relevant tag.</p> <ul style="list-style-type: none"> ■ Tag All <p>All frames, whether classified to the Port VLAN or not, are transmitted with a tag.</p> <ul style="list-style-type: none"> ■ Untag All <p>All frames, whether classified to the Port VLAN or not, are transmitted without a tag.</p> |
| <ul style="list-style-type: none"> • Allowed VLANs | <p>Ports in Trunk and Hybrid mode may control which VLANs they are allowed to become members of. The field's syntax is identical to the syntax used in the Enabled VLANs field.</p> <p>By default, a Trunk or Hybrid port will become member of all VLANs, and is therefore set to 1-4095. The field may be left empty, which means that the port will not become member of any VLANs.</p> |
| <ul style="list-style-type: none"> • Forbidden VLANs | <p>A port may be configured to never be member of one or more VLANs. This is particularly useful when dynamic VLAN protocols like MVRP and GVRP must be prevented from dynamically adding ports to VLANs. The trick is to mark such VLANs as forbidden on the port in question. The syntax is identical to the syntax used in the Enabled VLANs field.</p> <p>By default, the field is left blank, which means that the port may become a member of all possible VLANs.</p> |

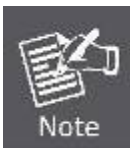

The port must be a member of the same VLAN as the Port VLAN ID.

Buttons



: Click to apply changes



: Click to undo any changes made locally and revert to previously saved values.

4.3.3.4 VLAN Membership Status

This page provides an overview of membership status for VLAN users. The VLAN Membership Status screen in [Figure 4-3-3-3](#) appears.

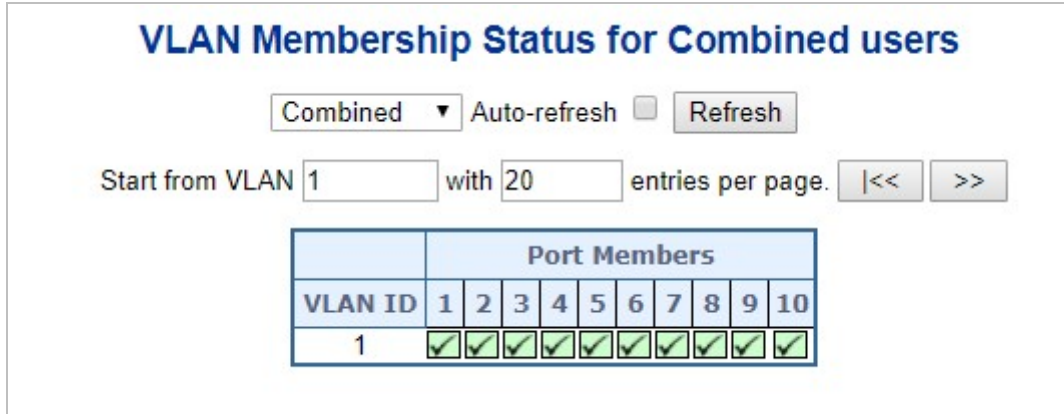

Figure 4-3-3-3: VLAN Membership Status for Static User Page Screenshot

The page includes the following fields:

| Object | Description |
|--|--|
| <ul style="list-style-type: none"> VLAN User | <p>A VLAN User is a module that uses services of the VLAN management functionality to configure VLAN memberships and VLAN port configuration such as PVID, UVID. Currently we support following VLAN :</p> <ul style="list-style-type: none"> - Admin : This is referred as static. - NAS : NAS provides port-based authentication, which involves communications between a Supplicant, Authenticator, and an Authentication Server. - GVRP : GVRP (GARP VLAN Registration Protocol or Generic VLAN Registration Protocol) is a protocol that facilitates control of virtual local area networks (VLANs) within a larger network . - Voice VLAN : Voice VLAN is a VLAN configured specially for voice traffic typically originating from IP phones. - MVR : MVR is used to eliminate the need to duplicate multicast traffic for subscribers in each VLAN. Multicast traffic for all channels is sent only on a single (multicast) VLAN. |
| <ul style="list-style-type: none"> Port Members | <p>A row of check boxes for each port is displayed for each VLAN ID.</p> <p>If a port is included in a VLAN, an image <input checked="" type="checkbox"/> will be displayed.</p> <p>If a port is included in a Forbidden port list, an image <input type="checkbox"/> will be displayed.</p> <p>If a port is included in a Forbidden port list and dynamic VLAN user register VLAN on same Forbidden port, then conflict port will be displayed as conflict port.</p> |
| <ul style="list-style-type: none"> VLAN Membership | <p>The VLAN Membership Status page shall show the current VLAN port members</p> |

| | |
|--|---|
| | for all VLANs configured by a selected VLAN User (selection shall be allowed by a Combo Box). When ALL VLAN Users are selected, it shall show this information for all the VLAN Users, and this is by default. VLAN membership allows the frames classified to the VLAN ID to be forwarded on the respective VLAN member ports. |
|--|---|

Buttons

: Select VLAN Users from this drop down list.

Auto-refresh : Check this box to refresh the page automatically. Automatic refresh occurs every 3 seconds.

: Click to refresh the page immediately.

: Updates the table starting from the first entry in the VLAN Table, i.e. the entry with the lowest VLAN ID.

: Updates the table, starting with the entry after the last entry currently displayed.

4.3.3.5 VLAN Port Status

This page provides VLAN Port Status. The VLAN Port Status screen in [Figure 4-3-3-4](#) appears.

VLAN Port Status for Combined users

Auto-refresh

| Port | Port Type | Ingress Filtering | Frame Type | Port VLAN ID | Tx Tag | Untagged VLAN ID | Conflicts |
|------|-----------|-------------------|------------|--------------|------------|------------------|-----------|
| 1 | C-Port | ✔ | All | 1 | Untag PVID | | No |
| 2 | C-Port | ✔ | All | 1 | Untag PVID | | No |
| 3 | C-Port | ✔ | All | 1 | Untag PVID | | No |
| 4 | C-Port | ✔ | All | 1 | Untag PVID | | No |
| 5 | C-Port | ✔ | All | 1 | Untag PVID | | No |
| 6 | C-Port | ✔ | All | 1 | Untag PVID | | No |
| 7 | C-Port | ✔ | All | 1 | Untag PVID | | No |
| | | ✔ | All | | | | No |

Figure 4-3-3-4: VLAN Port Status for Combined users Page Screenshot

The page includes the following fields:

| Object | Description |
|-------------|--|
| • Port | The logical port for the settings contained in the same row. |
| • Port Type | Show the VLAN Awareness for the port. |

| | |
|--|--|
| | <p>If VLAN awareness is enabled, the tag is removed from tagged frames received on the port. VLAN tagged frames are classified to the VLAN ID in the tag.</p> <p>If VLAN awareness is disabled, all frames are classified to the Port VLAN ID and tags are not removed.</p> |
| <ul style="list-style-type: none"> • Ingress Filtering | <p>Show the ingress filtering for a port. This parameter affects VLAN ingress processing. If ingress filtering is enabled and the ingress port is not a member of the classified VLAN of the frame, the frame is discarded.</p> |
| <ul style="list-style-type: none"> • Frame Type | <p>Shows whether the port accepts all frames or only tagged frames. This parameter affects VLAN ingress processing. If the port only accepts tagged frames, untagged frames received on that port are discarded.</p> |
| <ul style="list-style-type: none"> • Port VLAN ID | <p>Shows the PVID setting for the port.</p> |
| <ul style="list-style-type: none"> • Tx Tag | <p>Shows egress filtering frame status whether tagged or untagged.</p> |
| <ul style="list-style-type: none"> • Untagged VLAN ID | <p>Shows UVID (untagged VLAN ID). Port's UVID determines the packet's behavior at the egress side.</p> |
| <ul style="list-style-type: none"> • Conflicts | <p>Shows status of Conflicts whether exists or Not. When a Volatile VLAN User requests to set VLAN membership or VLAN port configuration, the following conflicts can occur:</p> <ul style="list-style-type: none"> ■ Functional Conflicts between feature. ■ Conflicts due to hardware limitation. ■ Direct conflict between user modules. |

Buttons

: Select VLAN Users from this drop down list.

Auto-refresh : Check this box to refresh the page automatically. Automatic refresh occurs every 3 seconds.

: Click to refresh the page immediately.

4.3.3.6 Private VLAN

The Private VLAN membership configurations for the switch can be monitored and modified here. Private VLANs can be added or deleted here. Port members of each Private VLAN can be added or removed here.

Private VLANs are based on the source port mask, and there are no connections to VLANs. This means that VLAN IDs and Private VLAN IDs can be identical.

A port must be a member of both a VLAN and a Private VLAN to be able to forward packets. By default, all ports are VLAN unaware and members of VLAN 1 and Private VLAN 1.

A VLAN unaware port can only be a member of one VLAN, but it can be a member of multiple Private VLANs. The VLAN Port Status screen in [Figure 4-3-3-5](#) appears.

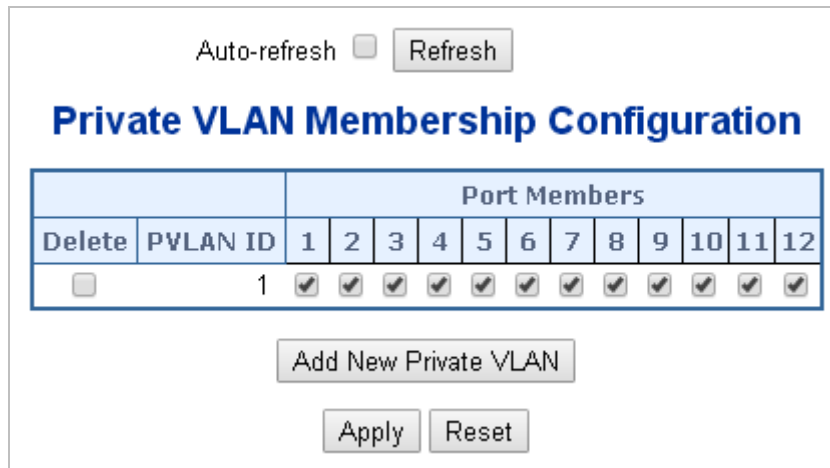

Figure 4-3-3-5: Private VLAN Membership Configuration page screenshot

The page includes the following fields:

| Object | Description |
|--|---|
| <ul style="list-style-type: none"> • Delete | To delete a private VLAN entry, check this box. The entry will be deleted during the next save. |
| <ul style="list-style-type: none"> • Private VLAN ID | Indicates the ID of this particular private VLAN. |
| <ul style="list-style-type: none"> • Port Members | A row of check boxes for each port is displayed for each private VLAN ID. To include a port in a Private VLAN, check the box. To remove or exclude the port from the Private VLAN, make sure the box is unchecked. By default, no ports are members, and all boxes are unchecked. |
| <ul style="list-style-type: none"> • Adding a New Private VLAN | Click "Add New Private VLAN" to add a new private VLAN ID. An empty row is added to the table, and the private VLAN can be configured as needed. The allowed range for a private VLAN ID is the same as the switch port number range. Any values outside this range are not accepted, and a warning message appears. Click "OK" to discard the incorrect entry, or click "Cancel" to return to the editing and make a correction. The Private VLAN is enabled when you click "Save". The "Delete" button can be used to undo the addition of new Private VLANs. |

Buttons

: Click to add new VLAN.

: Click to save changes.

: Click to undo any changes made locally and revert to previously saved values.

Auto-refresh : Check this box to refresh the page automatically. Automatic refresh occurs every 3 seconds.

: Click to refresh the page immediately.

4.3.3.7 Port Isolation

Overview

When a VLAN is configured to be a private VLAN, communication between ports within that VLAN can be prevented. Two application examples are provided in this section:

- Customers connected to an ISP can be members of the same VLAN, but they are not allowed to communicate with each other within that VLAN.
- Servers in a farm of web servers in a Demilitarized Zone (DMZ) are allowed to communicate with the outside world and with database servers on the inside segment, but are not allowed to communicate with each other

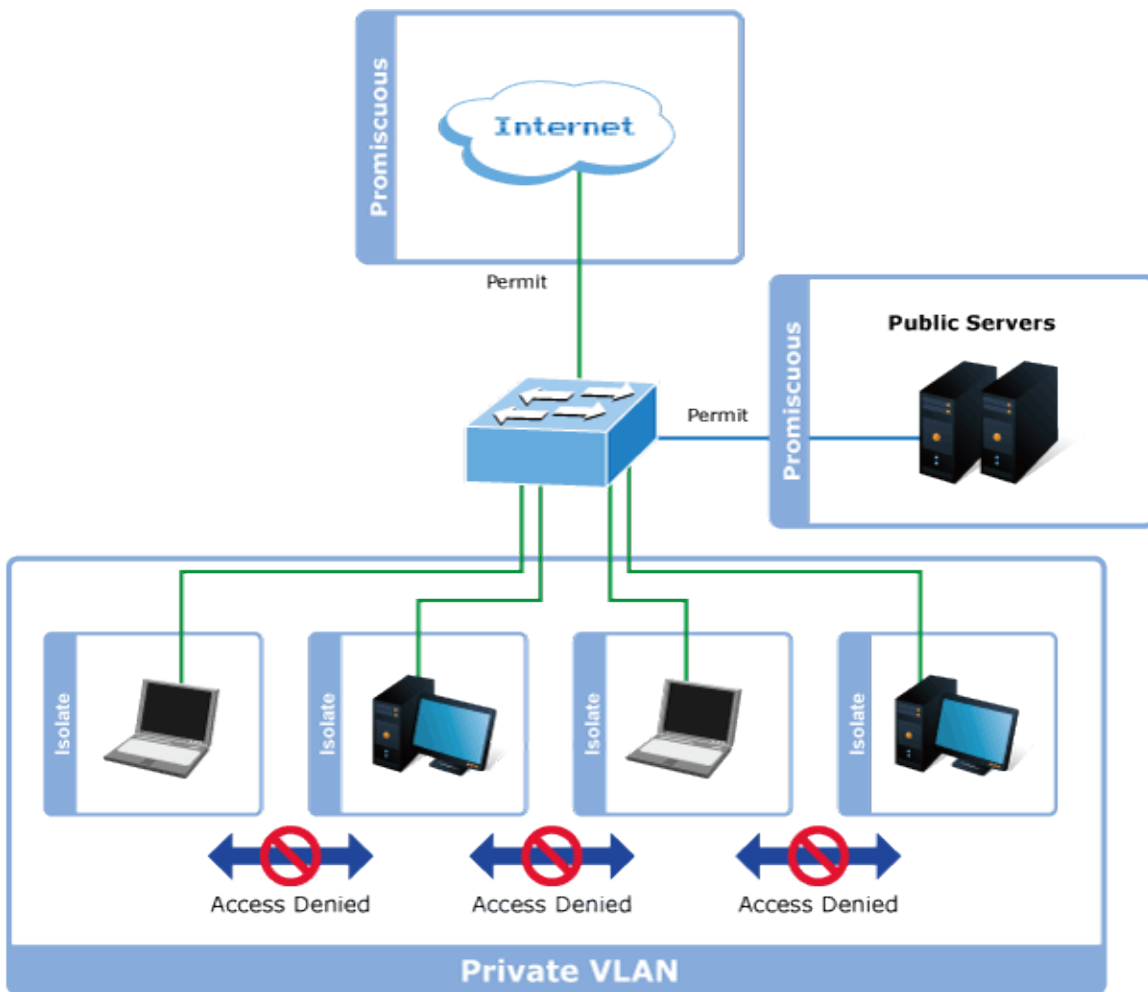

For private VLANs to be applied, the switch must first be configured for standard VLAN operation. When this is in place, one or more of the configured VLANs can be configured as private VLANs. Ports in a private VLAN fall into one of these two groups:

■ **Promiscuous ports**

- Ports from which traffic can be forwarded to all ports in the private VLAN
- Ports which can receive traffic from all ports in the private VLAN

■ **Isolated ports**

- Ports from which traffic can only be forwarded to promiscuous ports in the private VLAN
- Ports which can receive traffic from only promiscuous ports in the private VLAN

The configuration of promiscuous and isolated ports applies to all private VLANs. When traffic comes in on a promiscuous port in a private VLAN, the VLAN mask from the VLAN table is applied. When traffic comes in on an isolated port, the private VLAN mask is applied in addition to the VLAN mask from the VLAN table. This reduces the ports to which forwarding can be done to just the promiscuous ports within the private VLAN.

This page is used for enabling or disabling port isolation on ports in a Private VLAN. A port member of a VLAN can be isolated to other isolated ports on the same VLAN and Private VLAN. The Port Isolation screen in [Figure 4-3-3-6](#) appears.

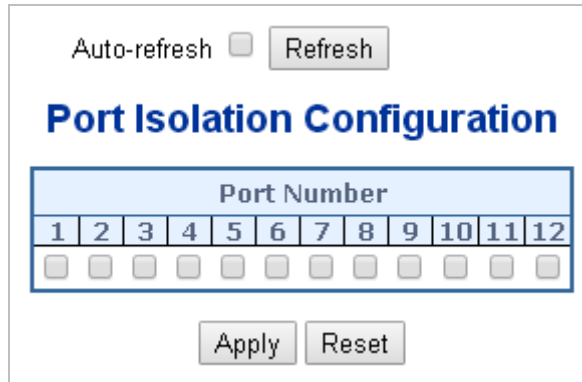



Figure 4-3-3-6: Port Isolation Configuration Page Screenshot

The page includes the following fields:

| Object | Description |
|---|---|
| <ul style="list-style-type: none"> • Port Members | <p>A check box is provided for each port of a private VLAN. When checked, port isolation is enabled on that port. When unchecked, port isolation is disabled on that port.</p> <p>By default, port isolation is disabled on all ports.</p> |

Buttons

 : Click to apply changes

 : Click to undo any changes made locally and revert to previously saved values.

Auto-refresh Check this box to refresh the page automatically. Automatic refresh occurs every 3 seconds.

 : Click to refresh the page immediately.

4.3.3.8 VLAN setting example:

- Separate VLAN
- 802.1Q VLAN Trunk
- Port Isolate

4.3.3.8.1 Two Separate 802.1Q VLANs

The diagram shows how the **Industrial Managed Switch** handle Tagged and Untagged traffic flow for two VLANs. VLAN Group 2 and VLAN Group 3 are separated VLAN. Each VLAN isolate network traffic so only members of the VLAN receive traffic from the same VLAN members. The screen in [Figure 4-3-3-7](#) appears and [Table 4-3-3-8](#) describes the port configuration of the **Industrial Managed Switches**.

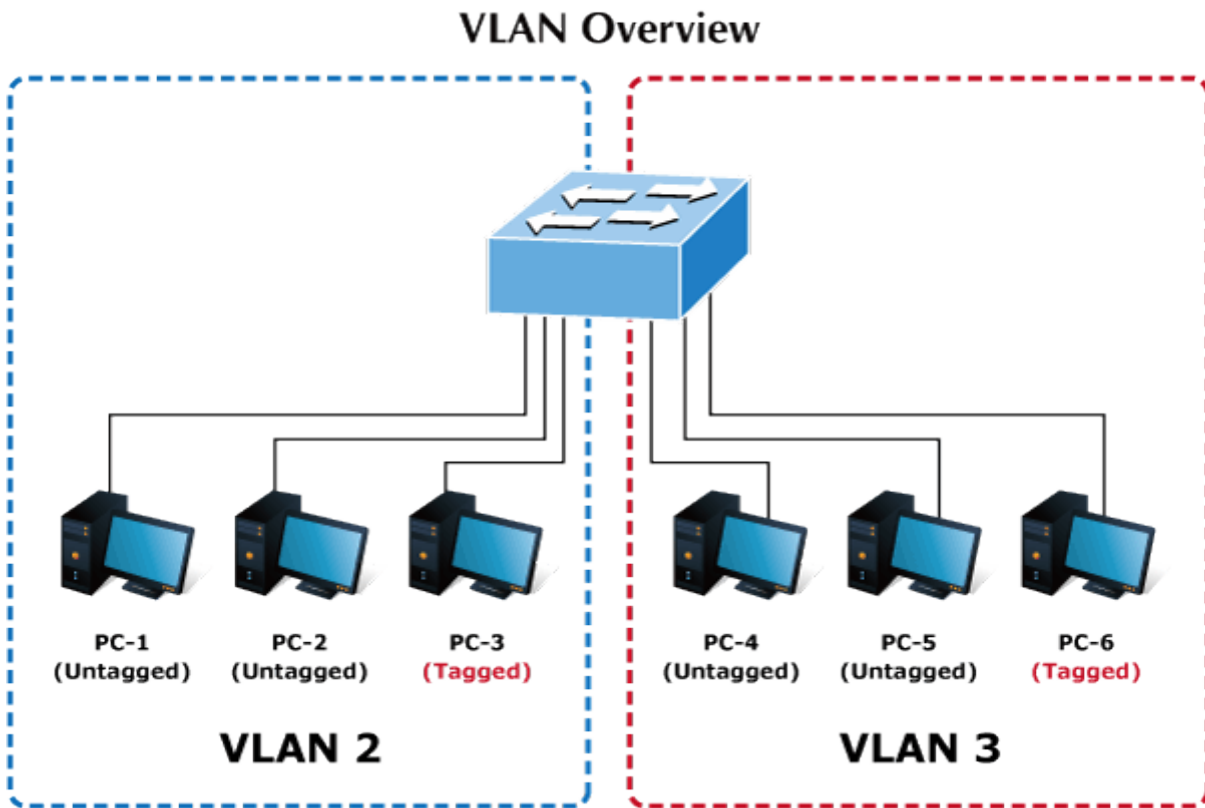

Figure 4-3-3-7: Two Separate VLANs Diagram

| VLAN Group | VID | Untagged Members | Tagged Members |
|--------------|-----|------------------|----------------|
| VLAN Group 1 | 1 | Port-7 ~ Port-52 | N/A |
| VLAN Group 2 | 2 | Port-1,Port-2 | Port-3 |
| VLAN Group 3 | 3 | Port-4,Port-5 | Port-6 |

Table 4-1: VLAN and Port Configuration

The scenario is described as follows:

- **Untagged packet entering VLAN 2**

1. While [PC-1] transmit an **untagged** packet enters **Port-1**, the **Industrial Managed Switch** will tag it with a **VLAN Tag=2**. [PC-2] and [PC-3] will received the packet through **Port-2** and **Port-3**.
2. [PC-4],[PC-5] and [PC-6] received no packet.
3. While the packet leaves **Port-2**, it will be stripped away it tag becoming an **untagged** packet.
4. While the packet leaves **Port-3**, it will keep as a **tagged** packet with **VLAN Tag=2**.
 - **Tagged packet entering VLAN 2**
5. While [PC-3] transmit a **tagged** packet with **VLAN Tag=2** enters **Port-3**, [PC-1] and [PC-2] will received the packet through **Port-1** and **Port-2**.
6. While the packet leaves **Port-1** and **Port-2**, it will be stripped away it tag becoming an **untagged** packet.
 - **Untagged packet entering VLAN 3**
 1. While [PC-4] transmit an **untagged** packet enters **Port-4**, the switch will tag it with a **VLAN Tag=3**. [PC-5] and [PC-6] will received the packet through **Port-5** and **Port-6**.
 2. While the packet leaves **Port-5**, it will be stripped away it tag becoming an **untagged** packet.
 3. While the packet leaves **Port-6**, it will keep as a **tagged** packet with **VLAN Tag=3**.



For this example, VLAN Group 1 just set as default VLAN, but only focus on VLAN 2 and VLAN 3 traffic flow

Setup steps

1. Add VLAN Group

Add two VLANs – VLAN 2 and VLAN 3

Type 1-3 in Allowed Access VLANs column, the 1-3 is including VLAN1 and 2 and 3.

| Global VLAN Configuration | |
|----------------------------------|------|
| Allowed Access VLANs | 1-3 |
| Ethertype for Custom S-ports | 88A8 |

Figure 4-3-3-8: Add VLAN 2 and VLAN 3

2. Assign VLAN Member and PVID for each port:

VLAN 2 : Port-1,Port-2 and Port-3

VLAN 3 : Port-4, Port-5 and Port-6

VLAN 1 : All other ports – Port-7~Port-52

| Global VLAN Configuration | | | | | | | | | |
|------------------------------|--------|-----------|-----------|-------------------------------------|---------------------|-----------------|---------------|-----------------|--|
| Allowed Access VLANs | | 1-3 | | | | | | | |
| Ethertype for Custom S-ports | | 88A8 | | | | | | | |
| Port VLAN Configuration | | | | | | | | | |
| Port | Mode | Port VLAN | Port Type | Ingress Filtering | Ingress Acceptance | Egress Tagging | Allowed VLANs | Forbidden VLANs | |
| * | <All> | 2 | <All> | <input type="checkbox"/> | <All> | <All> | 2 | | |
| 1 | Access | 2 | C-Port | <input checked="" type="checkbox"/> | Tagged and Untagged | Untag Port VLAN | 2 | | |
| 2 | Access | 2 | C-Port | <input checked="" type="checkbox"/> | Tagged and Untagged | Untag Port VLAN | 2 | | |
| 3 | Access | 2 | C-Port | <input checked="" type="checkbox"/> | Tagged and Untagged | Untag Port VLAN | 2 | | |
| 4 | Access | 3 | C-Port | <input checked="" type="checkbox"/> | Tagged and Untagged | Untag Port VLAN | 3 | | |
| 5 | Access | 3 | C-Port | <input checked="" type="checkbox"/> | Tagged and Untagged | Untag Port VLAN | 3 | | |
| 6 | Access | 3 | C-Port | <input checked="" type="checkbox"/> | Tagged and Untagged | Untag Port VLAN | 3 | | |
| 7 | Access | 1 | C-Port | <input checked="" type="checkbox"/> | Tagged and Untagged | Untag Port VLAN | 1 | | |
| 8 | Access | 1 | C-Port | <input checked="" type="checkbox"/> | Tagged and Untagged | Untag Port VLAN | 1 | | |
| 9 | Access | 1 | C-Port | <input checked="" type="checkbox"/> | Tagged and Untagged | Untag Port VLAN | 1 | | |
| 10 | Access | 1 | C-Port | <input checked="" type="checkbox"/> | Tagged and Untagged | Untag Port VLAN | 1 | | |

Figure 4-3-3-9: Change Port VLAN of Port 1~3 to be VLAN2 and Port VLAN of Port 4~6 to be VLAN3

3. Enable VLAN Tag for specific ports

Link Type: *Port-3* (VLAN-2) and *Port-6* (VLAN-3)

Change Port 3 Mode as Trunk, Selects Egress Tagging as Tag All and Types 2 in the Allowed VLANs column.

Change Port 6 Mode as Trunk and Selects Egress Tagging as Tag All and Types 3 in the Allowed VLANs column.

The Per Port VLAN configuration in Figure 4-3-3-10 appears.

| Global VLAN Configuration | | | | | | | | | |
|------------------------------|--------|-----------|-----------|-------------------------------------|---------------------|-----------------|---------------|-----------------|--|
| Allowed Access VLANs | | 1-3 | | | | | | | |
| Ethertype for Custom S-ports | | 88A8 | | | | | | | |
| Port VLAN Configuration | | | | | | | | | |
| Port | Mode | Port VLAN | Port Type | Ingress Filtering | Ingress Acceptance | Egress Tagging | Allowed VLANs | Forbidden VLANs | |
| * | <All> | 2 | <All> | <input type="checkbox"/> | <All> | <All> | 2 | | |
| 1 | Access | 2 | C-Port | <input checked="" type="checkbox"/> | Tagged and Untagged | Untag Port VLAN | 2 | | |
| 2 | Access | 2 | C-Port | <input checked="" type="checkbox"/> | Tagged and Untagged | Untag Port VLAN | 2 | | |
| 3 | Trunk | 2 | C-Port | <input checked="" type="checkbox"/> | Tagged Only | Tag All | 2 | | |
| 4 | Access | 3 | C-Port | <input checked="" type="checkbox"/> | Tagged and Untagged | Untag Port VLAN | 3 | | |
| 5 | Access | 3 | C-Port | <input checked="" type="checkbox"/> | Tagged and Untagged | Untag Port VLAN | 3 | | |
| 6 | Trunk | 3 | C-Port | <input checked="" type="checkbox"/> | Tagged Only | Tag All | 3 | | |
| 7 | Access | 1 | C-Port | <input checked="" type="checkbox"/> | Tagged and Untagged | Untag Port VLAN | 1 | | |

Figure 4-3-3-10: Check VLAN 2 and 3 Members on VLAN Membership Page

4.3.3.8.2 VLAN Trunking between two 802.1Q aware switches

The most cases are used for “Uplink” to other switches. VLANs are separated at different switches, but they need to access with other switches within the same VLAN group. The screen in Figure 4-3-3-11 appears.

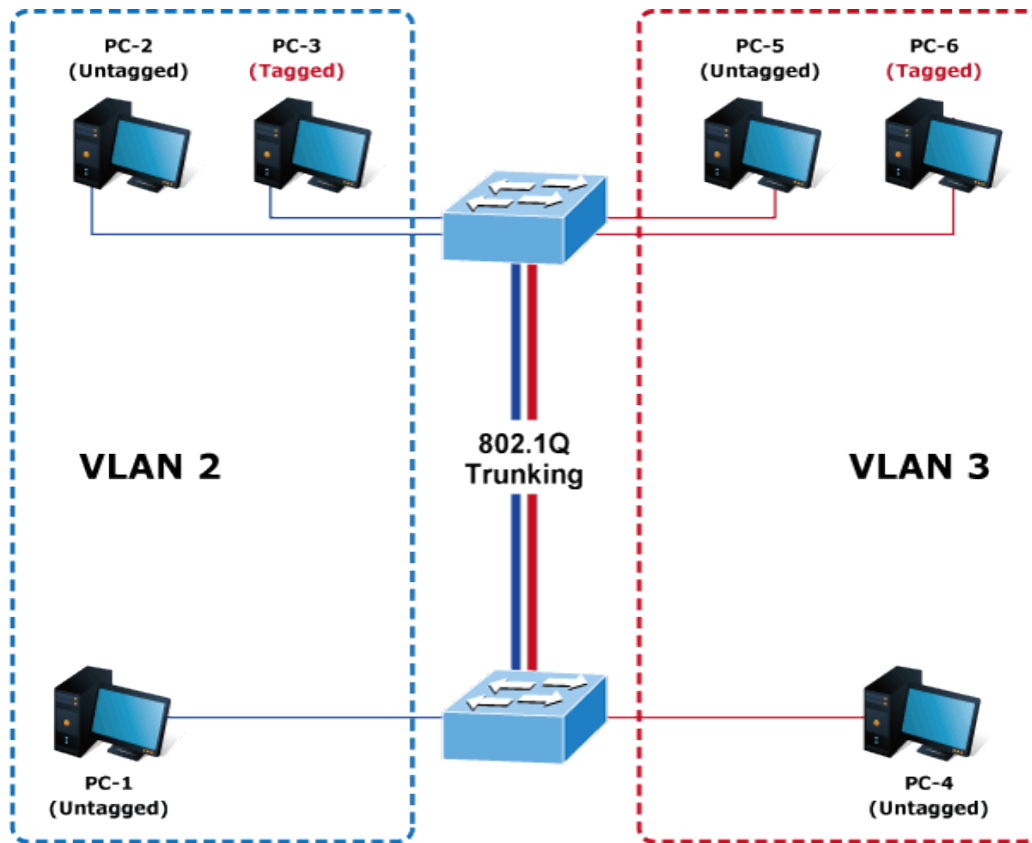

Figure 4-3-3-11: VLAN Trunking Diagram

Setup steps

1. Add VLAN Group

Add two VLANs – VLAN 2 and VLAN 3

Type 1-3 in Allowed Access VLANs column, the 1-3 is including VLAN1 and 2 and 3.

| Global VLAN Configuration | |
|------------------------------|------|
| Allowed Access VLANs | 1-3 |
| Ethertype for Custom S-ports | 88A8 |

Figure 4-3-3-12: Add VLAN 2 and VLAN 3

2. Assign VLAN Member and PVID for each port :

VLAN 2 : Port-1,Port-2 and Port-3

VLAN 3 : Port-4, Port-5 and Port-6

VLAN 1 : All other ports – Port-7~Port-52

Global VLAN Configuration

| | |
|------------------------------|------|
| Allowed Access VLANs | 1-3 |
| Ethertype for Custom S-ports | 88A8 |

Port VLAN Configuration

| Port | Mode | Port VLAN | Port Type | Ingress Filtering | Ingress Acceptance | Egress Tagging | Allowed VLANs | Forbidden VLANs |
|------|--------|-----------|-----------|-------------------------------------|---------------------|----------------|---------------|-----------------|
| * | <All> | 2 | <All> | <input type="checkbox"/> | <All> | <All> | 2 | |
| 1 | Access | 2 | C-Port | <input checked="" type="checkbox"/> | Tagged and Untagged | Untag All | 1 | |
| 2 | Access | 2 | C-Port | <input checked="" type="checkbox"/> | Tagged and Untagged | Untag All | 1 | |
| 3 | Access | 2 | C-Port | <input checked="" type="checkbox"/> | Tagged and Untagged | Untag All | 1 | |
| 4 | Access | 2 | C-Port | <input checked="" type="checkbox"/> | Tagged and Untagged | Untag All | 1 | |
| 5 | Access | 2 | C-Port | <input checked="" type="checkbox"/> | Tagged and Untagged | Untag All | 1 | |
| 6 | Access | 2 | C-Port | <input checked="" type="checkbox"/> | Tagged and Untagged | Untag All | 1 | |
| 7 | Access | 2 | C-Port | <input checked="" type="checkbox"/> | Tagged and Untagged | Untag All | 1 | |
| 8 | Access | 2 | C-Port | <input checked="" type="checkbox"/> | Tagged and Untagged | Untag All | 1 | |
| 9 | Access | 2 | C-Port | <input checked="" type="checkbox"/> | Tagged and Untagged | Untag All | 1 | |
| 10 | Access | 2 | C-Port | <input checked="" type="checkbox"/> | Tagged and Untagged | Untag All | 1 | |

Apply Reset

Figure 4-3-3-13: Changes Port VLAN of Port 1~3 to be VLAN2 and Port VLAN of Port 4~6 to be VLAN3

For the VLAN ports connecting to the hosts, please refer to 4.6.10.1 examples. The following steps will focus on the VLAN **Trunk port** configuration.

1. Specify **Port-7** to be the 802.1Q VLAN **Trunk port**.
2. Assign **Port-7** to both **VLAN 2** and **VLAN 3** at the VLAN Member configuration page.
3. Define a **VLAN 1** as a “**Public Area**” that overlapping with both **VLAN 2 members** and **VLAN 3 members**.
4. Assign the VLAN Trunk Port to be the member of each VLAN – which wants to be aggregated. For this example, add **Port-7** to be **VLAN 2** and **VLAN 3** member port.
5. Specify **Port-7** to be the 802.1Q VLAN **Trunk port**, and the Trunking port must be a **Tagged** port while egress. The Port-7 configuration is shown in [Figure 4-3-3-14](#).

Global VLAN Configuration

| | |
|------------------------------|------|
| Allowed Access VLANs | 1-3 |
| Ethertype for Custom S-ports | 88A8 |

Port VLAN Configuration

| Port | Mode | Port VLAN | Port Type | Ingress Filtering | Ingress Acceptance | Egress Tagging | Allowed VLANs | Forbidden VLANs |
|------|--------|-----------|-----------|-------------------------------------|---------------------|-----------------|---------------|-----------------|
| * | <All> | 2 | <All> | <input type="checkbox"/> | <All> | <All> | 2 | 1 |
| 1 | Access | 2 | C-Port | <input checked="" type="checkbox"/> | Tagged and Untagged | Untag Port VLAN | 2 | 1 |
| 2 | Access | 2 | C-Port | <input checked="" type="checkbox"/> | Tagged and Untagged | Untag Port VLAN | 2 | 1 |
| 3 | Access | 2 | C-Port | <input checked="" type="checkbox"/> | Tagged and Untagged | Untag Port VLAN | 2 | 1 |
| 4 | Access | 3 | C-Port | <input checked="" type="checkbox"/> | Tagged and Untagged | Untag Port VLAN | 3 | 1 |
| 5 | Access | 3 | C-Port | <input checked="" type="checkbox"/> | Tagged and Untagged | Untag Port VLAN | 3 | 1 |
| 6 | Access | 3 | C-Port | <input checked="" type="checkbox"/> | Tagged and Untagged | Untag Port VLAN | 3 | 1 |
| 7 | Trunk | 1 | C-Port | <input checked="" type="checkbox"/> | Tagged Only | Tag All | 1-3 | |
| 8 | Access | 1 | C-Port | <input checked="" type="checkbox"/> | Tagged and Untagged | Untag Port VLAN | 1 | |

Figure 4-3-3-14: VLAN Overlap Port Setting & VLAN 1 – The Public Area Member Assign

That is, although the VLAN 2 members: Port-1 to Port-3 and VLAN 3 members: Port-4 to Port-6 also belongs to VLAN 1. But with different PVID settings, packets from VLAN 2 or VLAN 3 is not able to access to the other VLAN.

6. Repeat Steps 1 to 6, set up the VLAN Trunk port at the partner switch and add more VLANs to join the VLAN trunk, repeat Steps 1 to 3 to assign the Trunk port to the VLANs.

4.3.3.8.3 Port Isolate

The diagram shows how the **Industrial Managed Switch** handles isolated and promiscuous ports, and the each PC is not able to access the isolated port of each other's PCs. But they all need to access with the same server/AP/Printer. This section will show you how to configure the port for the server – that could be accessed by each isolated port.

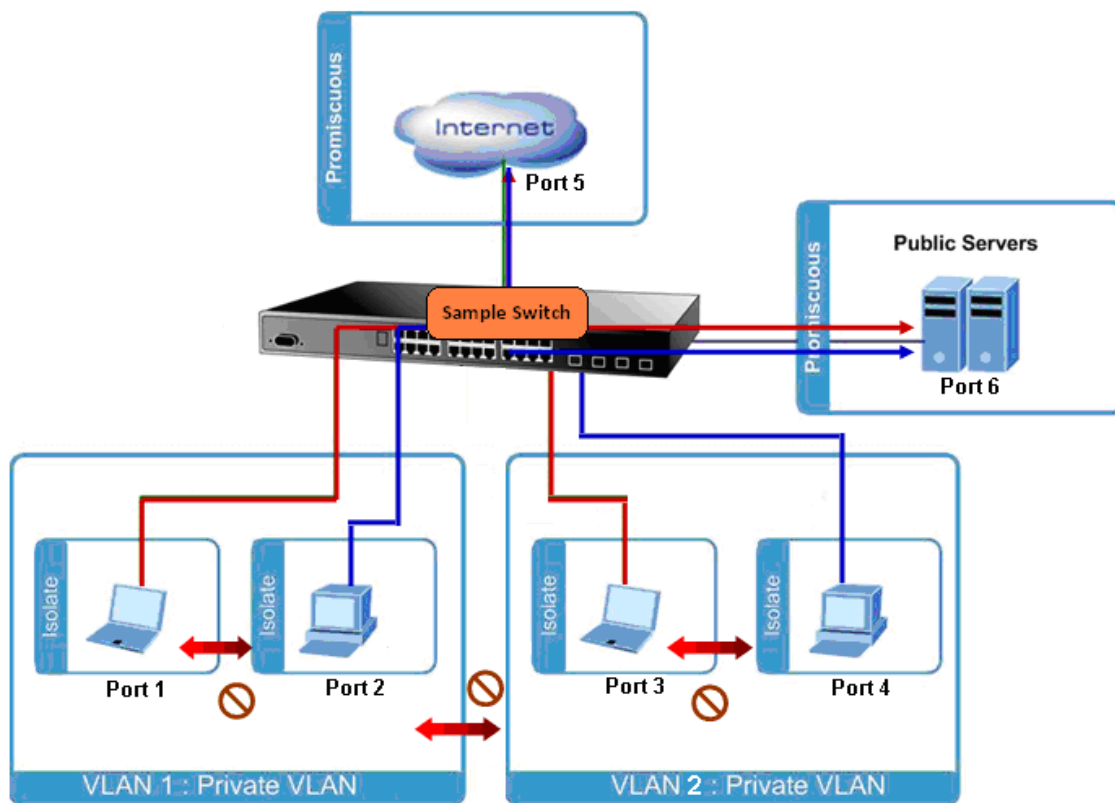

Setup steps

1. Assign Port Mode

Set Port-1~Port-4 in Isolate port.

Set Port5 and Port-6 in Promiscuous port. The screen in [Figure 4-3-3-15](#) appears.

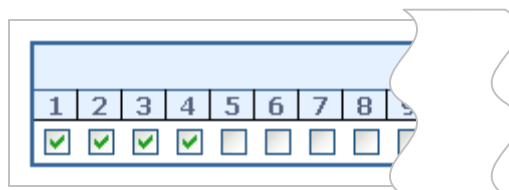

Figure 4-3-3-15: The Configuration of Isolated and Promiscuous Port

4.3.3.9 MAC-based VLAN

The MAC-based VLAN entries can be configured here. This page allows for adding and deleting MAC-based VLAN entries and assigning the entries to different ports. This page shows only static entries. The MAC-based VLAN screen in [Figure 4-3-3-16](#) appears.

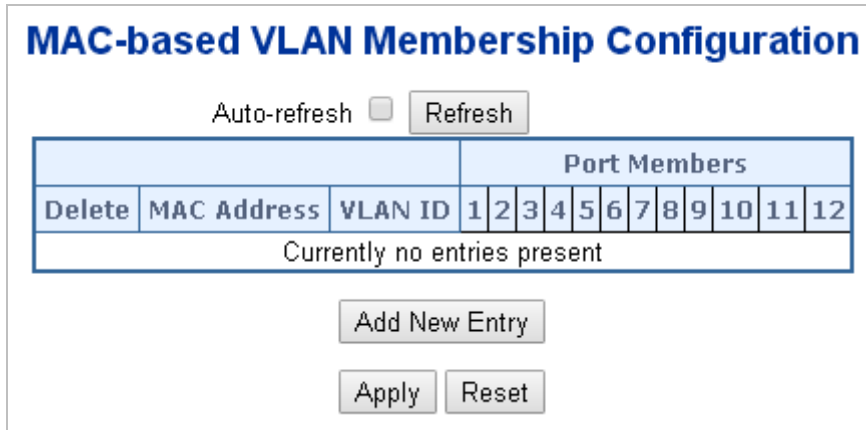



Figure 4-3-3-16: MAC-based VLAN Membership Configuration Page Screenshot

The page includes the following fields:

| Object | Description |
|--|--|
| <ul style="list-style-type: none"> • Delete | To delete a MAC-based VLAN entry, check this box and press save. |
| <ul style="list-style-type: none"> • MAC Address | Indicates the MAC address. |
| <ul style="list-style-type: none"> • VLAN ID | Indicates the VLAN ID. |
| <ul style="list-style-type: none"> • Port Members | A row of check boxes for each port is displayed for each MAC-based VLAN entry. To include a port in a MAC-based VLAN, check the box. To remove or exclude the port from the MAC-based VLAN, make sure the box is unchecked. By default, no ports are members, and all boxes are unchecked. |
| <ul style="list-style-type: none"> • Adding a New MAC-based VLAN | Click "Add New Entry" to add a new MAC-based VLAN entry. An empty row is added to the table, and the MAC-based VLAN entry can be configured as needed. Any unicast MAC address can be configured for the MAC-based VLAN entry. No broadcast or multicast MAC addresses are allowed. Legal values for a VLAN ID are 1 through 4095. The MAC-based VLAN entry is enabled when you click on "Save". A MAC-based VLAN without any port members will be deleted when you click "Save". The "Delete" button can be used to undo the addition of new MAC-based VLANs. |

Buttons

: Click to add a new MAC-based VLAN entry.

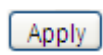
: Click to apply changes

Reset: Click to undo any changes made locally and revert to previously saved values.

Auto-refresh Check this box to refresh the page automatically. Automatic refresh occurs every 3 seconds.

Refresh: Click to refresh the page immediately.

<<: Updates the table starting from the first entry in the MAC-based VLAN Table.

>>: Updates the table, starting with the entry after the last entry currently displayed.

4.3.3.10 IP Subnet-based VLAN Membership Configuration

The IP subnet to VLAN ID mappings can be configured here. This page allows adding, updating and deleting IP subnet to VLAN ID mapping entries and assigning them to different ports. The MAC-based VLAN screen in [Figure 4-3-3-17](#) appears.

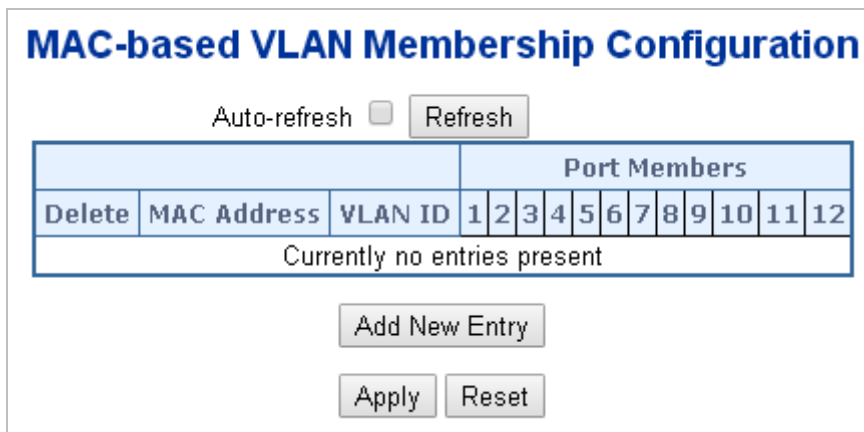

Figure 4-3-3-17: IP Subnet-based VLAN Membership Configuration page screenshot

The page includes the following fields:

| Object | Description |
|--|--|
| • Delete | To delete a MAC-based VLAN entry, check this box and press save. |
| • IP Address | Indicates the subnet's IP address (Any of the subnet's host addresses can be also provided here, the application will convert it automatically). |
| • Mask Length | Indicates the subnet's mask length. |
| • VLAN ID | Indicates the VLAN ID the subnet will be mapped to. IP Subnet to VLAN ID is a unique matching. |
| • Port Members | A row of check boxes for each port is displayed for each IP subnet to VLAN ID mapping entry. To include a port in a mapping, simply check the box. To remove or exclude the port from the mapping, make sure the box is unchecked. By default, no ports are members and all boxes are unchecked. |
| • Adding a New IP subnet-based VLAN | Click to add a new IP subnet to VLAN ID mapping entry. An empty row is added to the table, and the mapping can be configured as needed. Any IP |

| | |
|--|---|
| | <p>address/mask can be configured for the mapping. Legal values for the VLAN ID are 1 to 4095.</p> <p>The IP subnet to VLAN ID mapping entry is enabled when you click on "Apply".</p> <p>The delete button can be used to undo the addition of new mappings. The maximum possible IP subnet to VLAN ID mappings are limited to 128</p> |
|--|---|

Buttons

: Click to apply changes

: Click to undo any changes made locally and revert to previously saved values.

Auto-refresh Check this box to refresh the page automatically. Automatic refresh occurs every 3 seconds.

: Click to refresh the page immediately.

4.3.3.11 Protocol-based VLAN

This page allows you to add new protocols to Group Name (unique for each Group) mapping entries as well as allow you to see and delete already mapped entries for the switch. The Protocol-based VLAN screen in [Figure 4-3-3-18](#) appears.



Figure 4-3-3-18: Protocol to Group Mapping Table Page Screenshot

The page includes the following fields:

| Object | Description |
|---|--|
| <ul style="list-style-type: none"> Delete | To delete a Protocol to Group Name map entry, check this box. The entry will be deleted on the switch during the next Save. |
| <ul style="list-style-type: none"> Frame Type | <p>Frame Type can have one of the following values:</p> <ol style="list-style-type: none"> Ethernet LLC SNAP <p>Note: On changing the Frame type field, valid value of the following text field will</p> |

| | |
|---|--|
| | vary depending on the new frame type you selected. |
| <ul style="list-style-type: none"> • Value | <p>Valid value that can be entered in this text field depends on the option selected from the preceding Frame Type selection menu.</p> <p>Below is the criteria for three different Frame Types:</p> <ol style="list-style-type: none"> 1. For Ethernet: Values in the text field when Ethernet is selected as a Frame Type is called etype. Valid values for etype ranges from 0x0600-0xffff 2. For LLC: Valid value in this case is comprised of two different sub-values. <ol style="list-style-type: none"> a. DSAP: 1-byte long string (0x00-0xff) b. SSAP: 1-byte long string (0x00-0xff) 3. For SNAP: Valid value in this case also is comprised of two different sub-values. <ol style="list-style-type: none"> a. OUI: OUI (Organizationally Unique Identifier) is value in format of xx-xx-xx where each pair (xx) in string is a hexadecimal value ranges from 0x00-0xff. b. PID: If the OUI is hexadecimal 000000, the protocol ID is the Ethernet type (EtherType) field value for the protocol running on top of SNAP; if the OUI is an OUI for a particular organization, the protocol ID is a value assigned by that organization to the protocol running on top of SNAP. <p>In other words, if value of OUI field is 00-00-00 then value of PID will be etype (0x0600-0xffff) and if value of OUI is other than 00-00-00 then valid value of PID will be any value from 0x0000 to 0xffff.</p> |
| <ul style="list-style-type: none"> • Group Name | <p>A valid Group Name is a unique 16-character long string for every entry which consists of a combination of alphabets (a-z or A-Z) and integers(0-9).</p> <p>Note: special character and underscore(_) are not allowed.</p> |
| <ul style="list-style-type: none"> • Adding a New Group to VLAN mapping entry | <p>Click "Add New Entry" to add a new entry in mapping table. An empty row is added to the table; Frame Type, Value and the Group Name can be configured as needed.</p> <p>The "Delete" button can be used to undo the addition of new entry.</p> |

Buttons

Add New Entry : Click to add a new entry in mapping table.

Apply : Click to apply changes

Reset : Click to undo any changes made locally and revert to previously saved values.

Auto-refresh Check this box to refresh the page automatically. Automatic refresh occurs every 3 seconds.

Refresh : Click to refresh the page immediately.

4.3.3.12 Protocol-based VLAN Membership

This page allows you to map a already configured Group Name to a VLAN for the switch. The Group Name to VLAN Mapping Table screen in [Figure 4-6-19](#) appears.



Figure 4-3-19: Group Name to VLAN Mapping Table Page Screenshot

The page includes the following fields:

| Object | Description |
|---|--|
| <ul style="list-style-type: none"> Delete | To delete a Group Name to VLAN map entry, check this box. The entry will be deleted on the switch during the next Save |
| <ul style="list-style-type: none"> Group Name | A valid Group Name is a string of almost 16 characters which consists of a combination of alphabets (a-z or A-Z) and integers(0-9), no special character is allowed. Whichever Group name you try map to a VLAN must be present in Protocol to Group mapping table and must not be preused by any other existing mapping entry on this page. |
| <ul style="list-style-type: none"> VLAN ID | Indicates the ID to which Group Name will be mapped. A valid VLAN ID ranges from 1-4095. |
| <ul style="list-style-type: none"> Port Members | A row of check boxes for each port is displayed for each Group Name to VLAN ID mapping. To include a port in a mapping, check the box. To remove or exclude the port from the mapping, make sure the box is unchecked. By default, no ports are members, and all boxes are unchecked. |
| <ul style="list-style-type: none"> Adding a New Group to VLAN mapping entry | Click "Add New Entry" to add a new entry in mapping table. An empty row is added to the table, the Group Name, VLAN ID and port members can be |

| | |
|--|--|
| | configured as needed. Legal values for a VLAN ID are 1 through 4095. The "Delete" button can be used to undo the addition of new entry. |
|--|--|

Buttons

 : Click to apply changes

 : Click to undo any changes made locally and revert to previously saved values.

Auto-refresh Check this box to refresh the page automatically. Automatic refresh occurs every 3 seconds.

 : Click to refresh the page immediately.

4.3.4 Spanning Tree Protocol

4.3.4.1 Theory

The Spanning Tree protocol can be used to detect and disable network loops, and to provide backup links between switches, bridges or routers. This allows the switch to interact with other bridging devices in your network to ensure that only one route exists between any two stations on the network, and provide backup links which automatically take over when a primary link goes down. The spanning tree algorithms supported by this switch include these versions:

- **STP – Spanning Tree Protocol (IEEE 802.1D)**
- **RSTP – Rapid Spanning Tree Protocol (IEEE 802.1w)**
- **MSTP – Multiple Spanning Tree Protocol (IEEE 802.1s)**

The **IEEE 802.1D Spanning Tree** Protocol and **IEEE 802.1w Rapid Spanning Tree** Protocol allow for the blocking of links between switches that form loops within the network. When multiple links between switches are detected, a primary link is established. Duplicated links are blocked from use and become standby links. The protocol allows for the duplicate links to be used in the event of a failure of the primary link. Once the Spanning Tree Protocol is configured and enabled, primary links are established and duplicated links are blocked automatically. The reactivation of the blocked links (at the time of a primary link failure) is also accomplished automatically without operator intervention.

This automatic network reconfiguration provides maximum uptime to network users. However, the concepts of the Spanning Tree Algorithm and protocol are a complicated and complex subject and must be fully researched and understood. It is possible to cause serious degradation of the performance of the network if the Spanning Tree is incorrectly configured. Please read the following before making any changes from the default values.

The Switch STP performs the following functions:

- Creates a single spanning tree from any combination of switching or bridging elements.
- Creates multiple spanning trees – from any combination of ports contained within a single switch, in user specified groups.
- Automatically reconfigures the spanning tree to compensate for the failure, addition, or removal of any element in the tree.
- Reconfigures the spanning tree without operator intervention.

Bridge Protocol Data Units

For STP to arrive at a stable network topology, the following information is used:

- The unique switch identifier
- The path cost to the root associated with each switch port
- The port identifier

STP communicates between switches on the network using Bridge Protocol Data Units (BPDUs). Each BPDU contains the following information:

- The unique identifier of the switch that the transmitting switch currently believes is the root switch

- The path cost to the root from the transmitting port
- The port identifier of the transmitting port

The switch sends BPDUs to communicate and construct the spanning-tree topology. All switches connected to the LAN on which the packet is transmitted will receive the BPDU. BPDUs are not directly forwarded by the switch, but the receiving switch uses the information in the frame to calculate a BPDU, and, if the topology changes, initiates a BPDU transmission.

The communication between switches via BPDUs results in the following:

- One switch is elected as the root switch
- The shortest distance to the root switch is calculated for each switch
- A designated switch is selected. This is the switch closest to the root switch through which packets will be forwarded to the root.
- A port for each switch is selected. This is the port providing the best path from the switch to the root switch.
- Ports included in the STP are selected.

Creating a Stable STP Topology

It is to make the root port a fastest link. If all switches have STP enabled with default settings, the switch with the lowest MAC address in the network will become the root switch. By increasing the priority (lowering the priority number) of the best switch, STP can be forced to select the best switch as the root switch.

When STP is enabled using the default parameters, the path between source and destination stations in a switched network might not be ideal. For instance, connecting higher-speed links to a port that has a higher number than the current root port can cause a root-port change.

STP Port States

The BPDUs take some time to pass through a network. This propagation delay can result in topology changes where a port that transitioned directly from a Blocking state to a Forwarding state could create temporary data loops. Ports must wait for new network topology information to propagate throughout the network before starting to forward packets. They must also wait for the packet lifetime to expire for BPDU packets that were forwarded based on the old topology. The forward delay timer is used to allow the network topology to stabilize after a topology change. In addition, STP specifies a series of states a port must transition through to further ensure that a stable network topology is created after a topology change.

Each port on a switch using STP exists in one of the following five states:

- **Blocking** – the port is blocked from forwarding or receiving packets
- **Listening** – the port is waiting to receive BPDU packets that may tell the port to go back to the blocking state
- **Learning** – the port is adding addresses to its forwarding database, but not yet forwarding packets
- **Forwarding** – the port is forwarding packets
- **Disabled** – the port only responds to network management messages and must return to the blocking state first

A port transitions from one state to another as follows:

- From initialization (switch boot) to blocking
- From blocking to listening or to disabled
- From listening to learning or to disabled

- From learning to forwarding or to disabled
- From forwarding to disabled
- From disabled to blocking

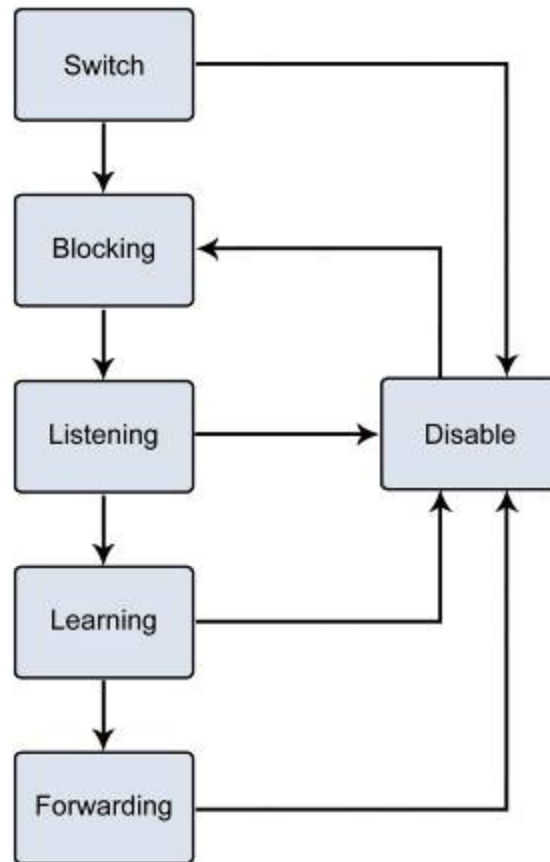



Figure 4-3-4-1: STP Port State Transitions

You can modify each port state by using management software. When you enable STP, every port on every switch in the network goes through the blocking state and then transitions through the states of listening and learning at power up. If properly configured, each port stabilizes to the forwarding or blocking state. No packets (except BPDUs) are forwarded from, or received by, STP enabled ports until the forwarding state is enabled for that port.

2. STP Parameters

STP Operation Levels

The Switch allows for two levels of operation: the switch level and the port level. The switch level forms a spanning tree consisting of links between one or more switches. The port level constructs a spanning tree consisting of groups of one or more ports. The STP operates in much the same way for both levels.

| | |
|---|---|
|  <p>Note</p> | <p>On the switch level, STP calculates the Bridge Identifier for each switch and then sets the Root Bridge and the Designated Bridges.</p> <p>On the port level, STP sets the Root Port and the Designated Ports.</p> |
|---|---|

The following are the user-configurable STP parameters for the switch level:

| Parameter | Description | Default Value |
|--|--|---------------|
| Bridge Identifier(Not user configurable except by setting priority below) | A combination of the User-set priority and the switch's MAC address. The Bridge Identifier consists of two parts: a 16-bit priority and a 48-bit Ethernet MAC address 32768 + MAC | 32768 + MAC |
| Priority | A relative priority for each switch – lower numbers give a higher priority and a greater chance of a given switch being elected as the root bridge | 32768 |
| Hello Time | The length of time between broadcasts of the hello message by the switch | 2 seconds |
| Maximum Age Timer | Measures the age of a received BPDU for a port and ensures that the BPDU is discarded when its age exceeds the value of the maximum age timer. | 20 seconds |
| Forward Delay Timer | The amount time spent by a port in the learning and listening states waiting for a BPDU that may return the port to the blocking state. | 15 seconds |

The following are the user-configurable STP parameters for the port or port group level:

| Variable | Description | Default Value |
|----------------------|---|--|
| Port Priority | A relative priority for each port –lower numbers give a higher priority and a greater chance of a given port being elected as the root port | 128 |
| Port Cost | A value used by STP to evaluate paths – STP calculates path costs and selects the path with the minimum cost as the active path | 200,000-100Mbps Fast Ethernet ports 20,000-100Mbps Gigabit Ethernet ports 0 - Auto |

Default Spanning-Tree Configuration

| Feature | Default Value |
|-----------------|----------------------------|
| Enable state | STP disabled for all ports |
| Port priority | 128 |
| Port cost | 0 |
| Bridge Priority | 32,768 |

User-Changeable STA Parameters

The Switch's factory default setting should cover the majority of installations. However, it is advisable to keep the default settings as set at the factory; unless, it is absolutely necessary. The user changeable parameters in the Switch are as follows:

Priority – A Priority for the switch can be set from 0 to 65535. 0 is equal to the highest Priority.

Hello Time – The Hello Time can be from 1 to 10 seconds. This is the interval between two transmissions of BPDU packets sent by the Root Bridge to tell all other Switches that it is indeed the Root Bridge. If you set a Hello Time for your Switch, and it is not the Root Bridge, the set Hello Time will be used if and when your Switch becomes the Root Bridge.

| | |
|---|---|
|  Note | The Hello Time cannot be longer than the Max. Age; otherwise, a configuration error will occur. |
|---|---|

Max. Age – The Max Age can be from 6 to 40 seconds. At the end of the Max Age, if a BPDU has still not been received from the Root Bridge, your Switch will start sending its own BPDU to all other Switches for permission to become the Root Bridge. If it turns out that your Switch has the lowest Bridge Identifier, it will become the Root Bridge.

Forward Delay Timer – The Forward Delay can be from 4 to 30 seconds. This is the time any port on the

Switch spends in the listening state while moving from the blocking state to the forwarding state.

| | |
|---|--|
|  Note | Observe the following formulas when setting the above parameters: Max. Age _ 2 x (Forward Delay - 1 second) Max. Age _ 2 x (Hello Time + 1 second) |
|---|--|

Port Priority – A Port Priority can be from 0 to 240. The lower the number, the greater the probability the port will be chosen as the Root Port.

Port Cost – A Port Cost can be set from 0 to 200000000. The lower the number, the greater the probability the port will be chosen to forward packets.

3. Illustration of STP

A simple illustration of three switches connected in a loop is depicted in the below diagram. In this example, you can anticipate some major network problems if the STP assistance is not applied.

If switch A broadcasts a packet to switch B, switch B will broadcast it to switch C, and switch C will broadcast it to back to switch A and so on. The broadcast packet will be passed indefinitely in a loop, potentially causing a network failure. In this example, STP breaks the loop by blocking the connection between switch B and C. The decision to block a particular connection is based on the STP calculation of the most current Bridge and Port settings.

Now, if switch A broadcasts a packet to switch C, then switch C will drop the packet at port 2 and the broadcast will end there. Setting-up STP using values other than the defaults, can be complex. Therefore, you are advised to keep the default factory settings and STP will automatically assign root bridges/ports and block loop connections. Influencing STP to choose a particular switch as the root bridge using the Priority setting, or influencing STP to choose a particular port to block using the Port Priority and Port Cost settings is, however, relatively straight forward.

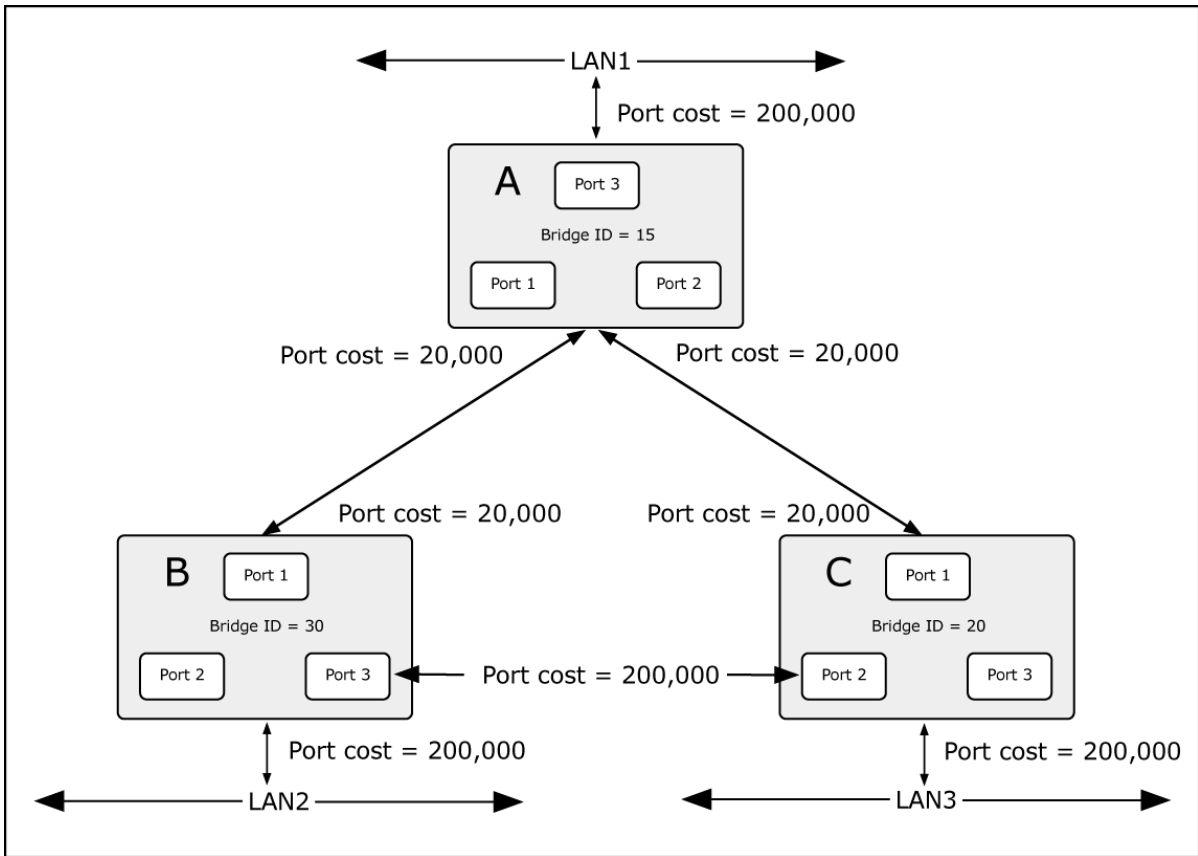

Figure 4-3-4-2: Before Applying the STA Rules

In this example, only the default STP values are used.

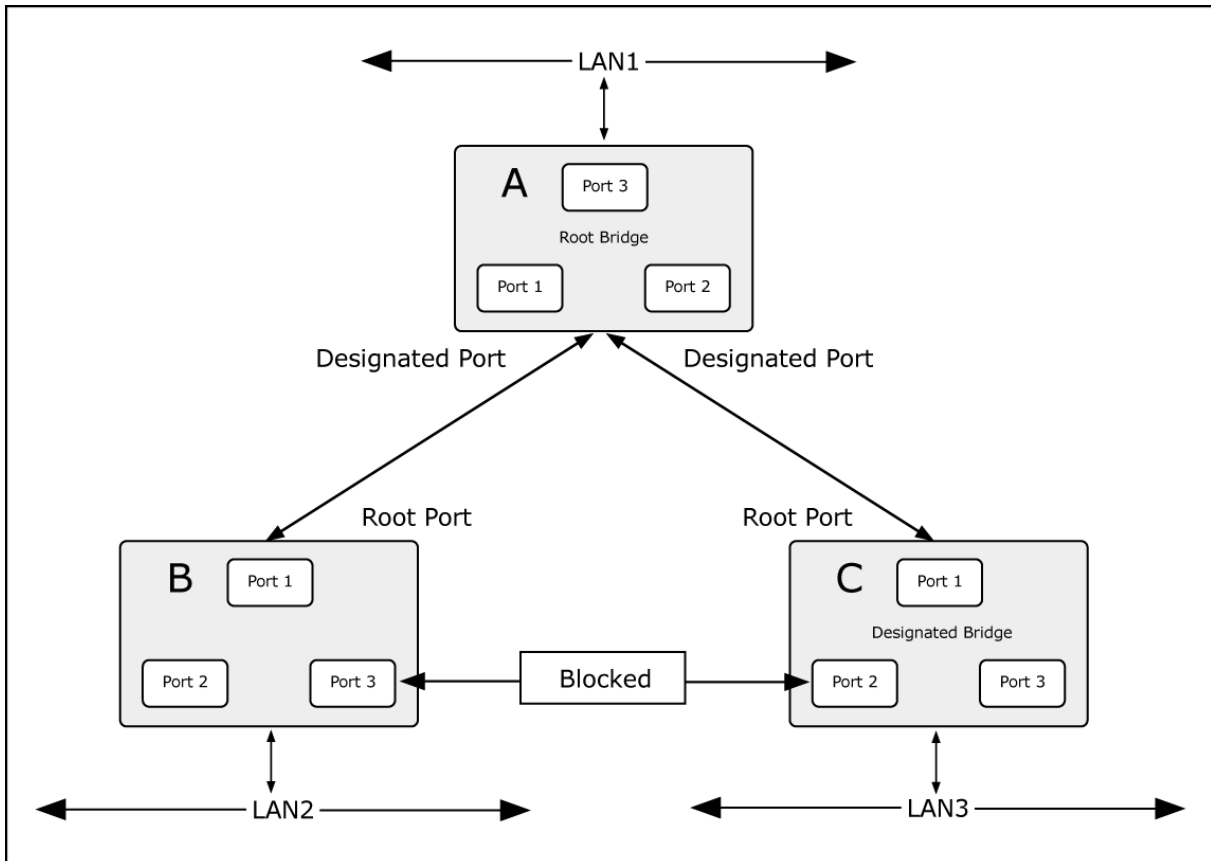

Figure 4-3-4-3: After Applying the STA Rules

The switch with the lowest Bridge ID (switch C) was elected the root bridge, and the ports were selected to give a high port cost between switches B and C. The two (optional) Gigabit ports (default port cost = 20,000) on switch A are connected to one (optional) Gigabit port on both switch B and C. The redundant link between switch B and C is deliberately chosen as a 100 Mbps Fast Ethernet link (default port cost = 200,000). Gigabit ports could be used, but the port cost should be increased from the default to ensure that the link between switch B and switch C is the blocked link.

4.3.4.2 STP System Configuration

This page allows you to configure STP system settings. The settings are used by all STP Bridge instances in the Switch. The **Industrial Managed Switch** support the following Spanning Tree protocols:

- **Compatible -- Spanning Tree Protocol (STP):** Provides a single path between end stations, avoiding and eliminating loops.
- **Normal -- Rapid Spanning Tree Protocol (RSTP) :** Detects and uses of network topologies that provide faster spanning tree convergence, without creating forwarding loops.
- **Extension – Multiple Spanning Tree Protocol (MSTP) :** Defines an extension to RSTP to further develop the usefulness of virtual LANs (VLANs). This "Per-VLAN" Multiple Spanning Tree Protocol configures a separate Spanning Tree for each VLAN group and blocks all but one of the possible alternate paths within each Spanning Tree.

The STP System Configuration screen in [Figure 4-3-4-4](#) appears.

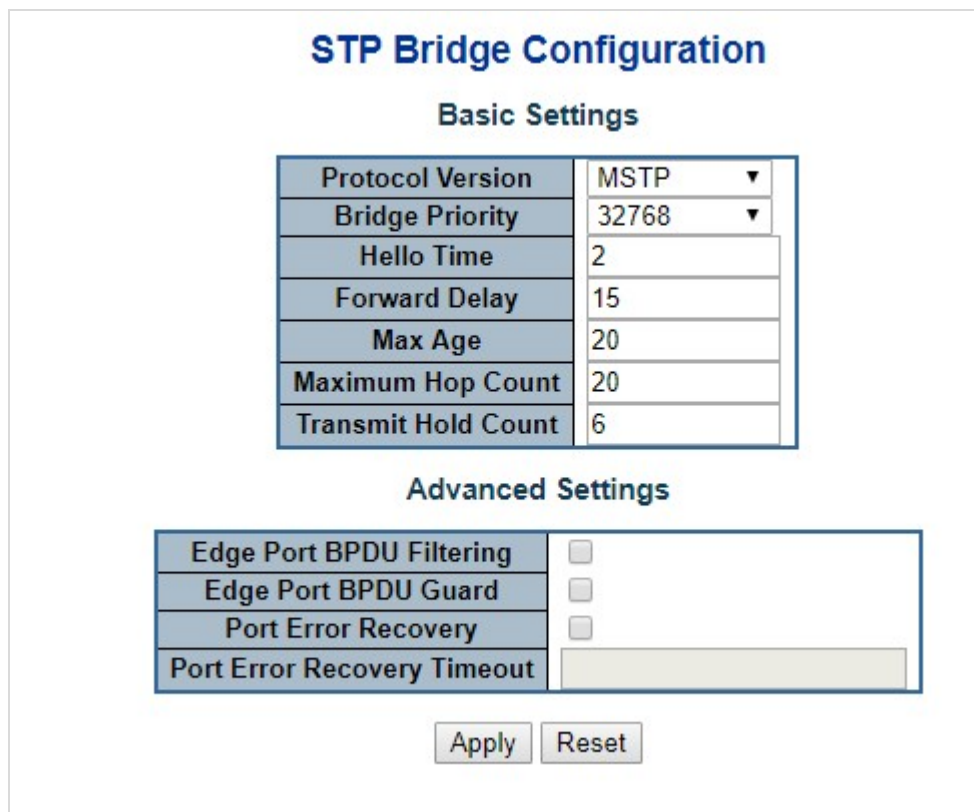

STP Bridge Configuration

Basic Settings

| | |
|---------------------|---------|
| Protocol Version | MSTP ▼ |
| Bridge Priority | 32768 ▼ |
| Hello Time | 2 |
| Forward Delay | 15 |
| Max Age | 20 |
| Maximum Hop Count | 20 |
| Transmit Hold Count | 6 |

Advanced Settings

| | |
|-----------------------------|---|
| Edge Port BPDU Filtering | <input type="checkbox"/> |
| Edge Port BPDU Guard | <input type="checkbox"/> |
| Port Error Recovery | <input type="checkbox"/> |
| Port Error Recovery Timeout | <input style="width: 100%;" type="text"/> |

Figure 4-3-4-4: STP Bridge Configuration Page Screenshot

The page includes the following fields:

Basic Settings

| Object | Description |
|--|--|
| <ul style="list-style-type: none"> • Protocol Version | <p>The STP protocol version setting. Valid values are:</p> <ul style="list-style-type: none"> ■ STP (IEEE 802.1D Spanning Tree Protocol) ■ RSTP (IEEE 802.2w Rapid Spanning Tree Protocol) ■ MSTP (IEEE 802.1s Multiple Spanning Tree Protocol) |
| <ul style="list-style-type: none"> • Bridge Priority | <p>Controls the bridge priority. Lower numeric values have better priority. The bridge priority plus the MSTI instance number, concatenated with the 6-byte MAC address of the switch forms a Bridge Identifier.</p> <p>For MSTP operation, this is the priority of the CIST. Otherwise, this is the priority of the STP/RSTP bridge.</p> |
| <ul style="list-style-type: none"> • Hello Time | <p>The interval between sending STP BPDU's. Valid values are in the range 1 to 10 seconds, default is 2 seconds</p> |
| <ul style="list-style-type: none"> • Forward Delay | <p>The delay used by STP Bridges to transition Root and Designated Ports to Forwarding (used in STP compatible mode). Valid values are in the range 4 to 30 seconds</p> <p>-Default: 15</p> <p>-Minimum: The higher of 4 or $[(\text{Max. Message Age} / 2) + 1]$</p> <p>-Maximum: 30</p> |
| <ul style="list-style-type: none"> • Max Age | <p>The maximum age of the information transmitted by the Bridge when it is the Root Bridge. Valid values are in the range 6 to 40 seconds.</p> <p>-Default: 20</p> <p>-Minimum: The higher of 6 or $[2 \times (\text{Hello Time} + 1)]$.</p> <p>-Maximum: The lower of 40 or $[2 \times (\text{Forward Delay} - 1)]$</p> |
| <ul style="list-style-type: none"> • Maximum Hop Count | <p>This defines the initial value of remaining Hops for MSTI information generated at the boundary of an MSTI region. It defines how many bridges a root bridge can distribute its BPDU information. Valid values are in the range 6 to 40 hops.</p> |
| <ul style="list-style-type: none"> • Transmit Hold Count | <p>The number of BPDU's a bridge port can send per second. When exceeded, transmission of the next BPDU will be delayed. Valid values are in the range 1 to 10 BPDU's per second.</p> |

Advanced Settings

| Object | Description |
|---|---|
| <ul style="list-style-type: none"> • Edge Port BPDU Filtering | <p>Control whether a port explicitly configured as Edge will transmit and receive BPDU's.</p> |

| | |
|--|---|
| <ul style="list-style-type: none"> • Edge Port BPDU Guard | Control whether a port explicitly configured as Edge will disable itself upon reception of a BPDU. The port will enter the error-disabled state, and will be removed from the active topology. |
| <ul style="list-style-type: none"> • Port Error Recovery | Control whether a port in the error-disabled state automatically will be enabled after a certain time. If recovery is not enabled, ports have to be disabled and re-enabled for normal STP operation. The condition is also cleared by a system reboot. |
| <ul style="list-style-type: none"> • Port Error Recovery Timeout | The time that has to pass before a port in the <i>error-disabled</i> state can be enabled. Valid values are between 30 and 86400 seconds (24 hours). |



The **Industrial Managed Switch** implements the Rapid Spanning Protocol as the default spanning tree protocol. When selecting “**Compatibles**” mode, the system uses the RSTP (802.1w) to be compatible and to co-work with another STP (802.1D)’s BPDU control packet.

Buttons



: Click to apply changes



: Click to undo any changes made locally and revert to previously saved values.

4.3.4.3 Bridge Status

This page provides a status overview for all STP bridge instances. The displayed table contains a row for each STP bridge instance, where the column displays the following information: The Bridge Status screen in [Figure 4-3-4-5](#) appears.

| STP Bridges | | | | | | |
|----------------------|-------------------------|-------------------------|------|------|---------------|----------------------|
| MSTI | Bridge ID | Root | | | Topology Flag | Topology Change Last |
| | | ID | Port | Cost | | |
| CIST | 80:00-00:30:4F:11:22:55 | 80:00-00:30:4F:11:22:55 | - | 0 | Steady | - |

Auto-refresh [Refresh](#)

Figure 4-3-4-5: STP Bridge Status Page Screenshot

The page includes the following fields:

| Object | Description |
|--|---|
| <ul style="list-style-type: none"> • MSTI | The Bridge Instance. This is also a link to the STP Detailed Bridge Status. |
| <ul style="list-style-type: none"> • Bridge ID | The Bridge ID of this Bridge instance. |
| <ul style="list-style-type: none"> • Root ID | The Bridge ID of the currently elected root bridge. |

| | |
|-------------------------------|--|
| • Root Port | The switch port currently assigned the <i>root</i> port role. |
| • Root Cost | Root Path Cost. For the Root Bridge this is zero. For all other Bridges, it is the sum of the Port Path Costs on the least cost path to the Root Bridge. |
| • Topology Flag | The current state of the Topology Change Flag for this Bridge instance. |
| • Topology Change Last | The time since last Topology Change occurred. |

Buttons

Auto-refresh Check this box to refresh the page automatically. Automatic refresh occurs every 3 seconds.

: Click to refresh the page immediately.

4.3.4.4 CIST Port Configuration

This page allows the user to inspect the current STP CIST port configurations, and possibly change them as well. The CIST Port Configuration screen in [Figure 4-3-4-6](#) appears.

STP CIST Port Configuration

CIST Aggregated Port Configuration

| Port | STP Enabled | Path Cost | Priority | Admin Edge | Auto Edge | Restricted | | BPDU Guard | Point-to-Point |
|------|--------------------------|-----------|----------|------------|-------------------------------------|--------------------------|--------------------------|--------------------------|----------------|
| | | | | | | Role | TCN | | |
| - | <input type="checkbox"/> | Auto | 128 | Non-Edge | <input checked="" type="checkbox"/> | <input type="checkbox"/> | <input type="checkbox"/> | <input type="checkbox"/> | Forced True |

CIST Normal Port Configuration

| Port | STP Enabled | Path Cost | Priority | Admin Edge | Auto Edge | Restricted | | BPDU Guard | Point-to-Point |
|------|--------------------------|-----------|----------|------------|-------------------------------------|--------------------------|--------------------------|--------------------------|----------------|
| | | | | | | Role | TCN | | |
| * | <input type="checkbox"/> | <All> | <All> | <All> | <input type="checkbox"/> | <input type="checkbox"/> | <input type="checkbox"/> | <input type="checkbox"/> | <All> |
| 1 | <input type="checkbox"/> | Auto | 128 | Non-Edge | <input checked="" type="checkbox"/> | <input type="checkbox"/> | <input type="checkbox"/> | <input type="checkbox"/> | Auto |
| 2 | <input type="checkbox"/> | Auto | 128 | Non-Edge | <input checked="" type="checkbox"/> | <input type="checkbox"/> | <input type="checkbox"/> | <input type="checkbox"/> | Auto |
| 3 | <input type="checkbox"/> | Auto | 128 | Non-Edge | <input checked="" type="checkbox"/> | <input type="checkbox"/> | <input type="checkbox"/> | <input type="checkbox"/> | Auto |
| 4 | <input type="checkbox"/> | Auto | 128 | Non-Edge | <input checked="" type="checkbox"/> | <input type="checkbox"/> | <input type="checkbox"/> | <input type="checkbox"/> | Auto |
| 5 | <input type="checkbox"/> | Auto | 128 | Non-Edge | <input checked="" type="checkbox"/> | <input type="checkbox"/> | <input type="checkbox"/> | <input type="checkbox"/> | Auto |
| 6 | <input type="checkbox"/> | Auto | 128 | Non-Edge | <input checked="" type="checkbox"/> | <input type="checkbox"/> | <input type="checkbox"/> | <input type="checkbox"/> | Auto |
| 7 | <input type="checkbox"/> | Auto | 128 | Non-Edge | <input checked="" type="checkbox"/> | <input type="checkbox"/> | <input type="checkbox"/> | <input type="checkbox"/> | Auto |
| 8 | <input type="checkbox"/> | Auto | 128 | Non-Edge | <input checked="" type="checkbox"/> | <input type="checkbox"/> | <input type="checkbox"/> | <input type="checkbox"/> | Auto |

Figure 4-3-4-6 : STP CIST Port Configuration Page Screenshot

The page includes the following fields:

| Object | Description |
|--------------------------|---|
| • Port | The switch port number of the logical STP port. |
| • STP Enabled | Controls whether RSTP is enabled on this switch port. |
| • Path Cost | Controls the path cost incurred by the port. The Auto setting will set the path cost as appropriate by the physical link speed, using the 802.1D recommended values. Using the Specific setting, a user-defined value can be entered. The path cost is used when establishing the active topology of the network. Lower path cost ports are chosen as forwarding ports in favor of higher path cost ports. Valid values are in the range 1 to 200000000. |
| • Priority | Controls the port priority. This can be used to control priority of ports having identical port cost. (See above). Default: 128 Range: 0-240, in steps of 16 |
| • AdminEdge | Controls whether the operEdge flag should start as being set or cleared. (The initial operEdge state when a port is initialized). |
| • AutoEdge | Controls whether the bridge should enable automatic edge detection on the bridge port. This allows operEdge to be derived from whether BPDU's are received on the port or not. |
| • Restricted Role | If enabled, causes the port not to be selected as Root Port for the CIST or any MSTI, even if it has the best spanning tree priority vector. Such a port will be selected as an Alternate Port after the Root Port has been selected. If set, it can cause lack of spanning tree connectivity. It can be set by a network administrator to prevent bridges external to a core region of the network influence the spanning tree active topology, possibly because those bridges are not under the full control of the administrator. This feature is also known as Root Guard . |
| • Restricted TCN | If enabled, causes the port not to propagate received topology change notifications and topology changes to other ports. If set it can cause temporary loss of connectivity after changes in a spanning tree's active topology as a result of persistently incorrect learned station location information. It is set by a network administrator to prevent bridges external to a core region of the network, causing address flushing in that region, possibly because those bridges are not under the full control of the administrator or the physical link state of the attached LANs transits frequently. |
| • BPDU Guard | If enabled, causes the port to disable itself upon receiving valid BPDU's. Contrary to the similar bridge setting, the port Edge status does not effect this setting. A port entering error-disabled state due to this setting is subject to the bridge Port Error Recovery setting as well. |

| | |
|---|--|
| <ul style="list-style-type: none"> • Point-to-point | <p>Controls whether the port connects to a point-to-point LAN rather than a shared medium. This can be automatically determined, or forced either true or false.</p> <p>Transitions to the forwarding state is faster for point-to-point LANs than for shared media.</p> |
|---|--|

Buttons



: Click to apply changes



: Click to undo any changes made locally and revert to previously saved values.

By default, the system automatically detects the speed and duplex mode used on each port, and configures the path cost according to the values shown below. Path cost "0" is used to indicate auto-configuration mode. When the short path cost method is selected and the default path cost recommended by the IEEE 8021w standard exceeds 65,535, the default is set to 65,535.

| Port Type | IEEE 802.1D-1998 | IEEE 802.1w-2001 |
|-------------------------|------------------|--------------------|
| Ethernet | 50-600 | 200,000-20,000,000 |
| Fast Ethernet | 10-60 | 20,000-2,000,000 |
| Gigabit Ethernet | 3-10 | 2,000-200,000 |

Table 4-3-4-1: Recommended STP Path Cost Range

| Port Type | Link Type | IEEE 802.1D-1998 | IEEE 802.1w-2001 |
|-------------------------|-------------|------------------|------------------|
| Ethernet | Half Duplex | 100 | 2,000,000 |
| | Full Duplex | 95 | 1,999,999 |
| | Trunk | 90 | 1,000,000 |
| Fast Ethernet | Half Duplex | 19 | 200,000 |
| | Full Duplex | 18 | 100,000 |
| | Trunk | 15 | 50,000 |
| Gigabit Ethernet | Full Duplex | 4 | 10,000 |
| | Trunk | 3 | 5,000 |

Table 4-3-4-2: Recommended STP Path Costs

| Port Type | Link Type | IEEE 802.1w-2001 |
|-------------------------|-------------|------------------|
| Ethernet | Half Duplex | 2,000,000 |
| | Full Duplex | 1,000,000 |
| | Trunk | 500,000 |
| Fast Ethernet | Half Duplex | 200,000 |
| | Full Duplex | 100,000 |
| | Trunk | 50,000 |
| Gigabit Ethernet | Full Duplex | 10,000 |
| | Trunk | 5,000 |

Table 4-3-4-3: Default STP Path Costs

4.3.4.5 MSTI Priorities

This page allows the user to inspect the current STP MSTI bridge instance priority configurations, and possibly change them as well. The MSTI Priority screen in [Figure 4-3-4-7](#) appears.

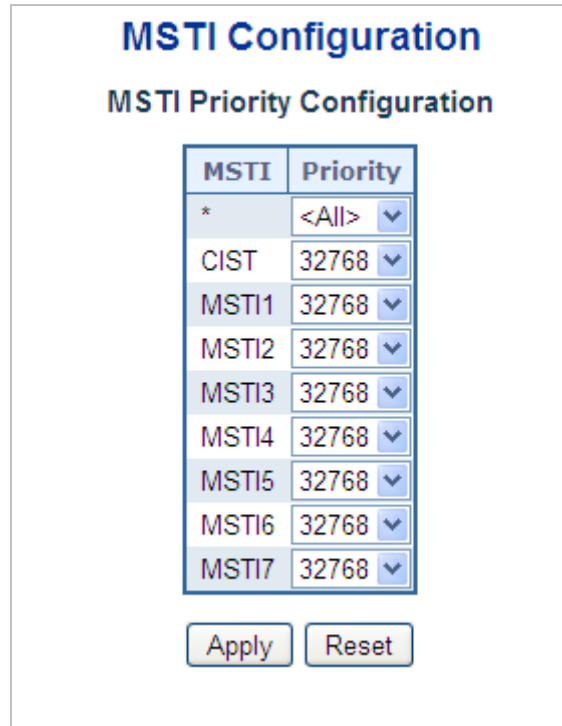
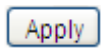

Figure 4-3-4-7: MSTI Priority Page Screenshot

The page includes the following fields:

| Object | Description |
|---|---|
| <ul style="list-style-type: none"> MSTI | The bridge instance. The CIST is the default instance, which is always active. |
| <ul style="list-style-type: none"> Priority | Controls the bridge priority. Lower numerical values have better priority. The bridge priority plus the MSTI instance number, concatenated with the 6-byte MAC address of the switch forms a Bridge Identifier. |

Buttons



: Click to apply changes

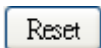

: Click to undo any changes made locally and revert to previously saved values.

4.3.4.6 MSTI Configuration

This page allows the user to inspect the current STP MSTI bridge instance priority configurations, and possibly change them as well. The MSTI Configuration screen in [Figure 4-3-4-8](#) appears.

MSTI Configuration

Add VLANs separated by spaces or comma.

Unmapped VLANs are mapped to the CIST. (The default bridge instance).

Configuration Identification

| | |
|------------------------|-------------------|
| Configuration Name | 00-30-4f-11-22-33 |
| Configuration Revision | 0 |

MSTI Mapping

| MSTI | VLANs Mapped | |
|-------|--------------|--------|
| MSTI1 | | ↑ ↓ |
| MSTI2 | | ↑ ↓ |
| MSTI3 | | ↑ ↓ |
| MSTI4 | | ↑ ↓ |
| MSTI5 | | ↑ ↓ |
| MSTI6 | | ↑ ↓ |
| MSTI7 | | ↑ ↓ |

Figure 4-3-4-8: MSTI Configuration Page Screenshot

The page includes the following fields:

Configuration Identification

| Object | Description |
|---|--|
| <ul style="list-style-type: none"> • Configuration Name | The name identifying the VLAN to MSTI mapping. Bridges must share the name and revision (see below), as well as the VLAN-to-MSTI mapping configuration in order to share spanning trees for MSTI's. (Intra-region). The name is at most 32 characters. |
| <ul style="list-style-type: none"> • Configuration Revision | The revision of the MSTI configuration named above. This must be an integer between 0 and 65535. |

MSTI Mapping

| Object | Description |
|---|--|
| <ul style="list-style-type: none"> • MSTI | The bridge instance. The CIST is not available for explicit mapping, as it will receive the VLANs not explicitly mapped. |
| <ul style="list-style-type: none"> • VLANs Mapped | The list of VLAN's mapped to the MSTI. The VLANs must be separated with comma and/or space. A VLAN can only be mapped to <i>one</i> MSTI. A unused MSTI should just be left empty. (I.e. not having any VLANs mapped to it.) |

Buttons

 : Click to apply changes

 : Click to undo any changes made locally and revert to previously saved values.

4.3.4.7 MSTI Ports Configuration

This page allows the user to inspect the current STP MSTI port configurations, and possibly change them as well. A MSTI port is a virtual port, which is instantiated separately for each active CIST (physical) port for each MSTI instance configured and applicable for the port. The MSTI instance must be selected before displaying actual MSTI port configuration options.

This page contains MSTI port settings for physical and aggregated ports. The aggregation settings are global. The MSTI Port Configuration screen in [Figure 4-3-4-9](#) & [Figure 4-3-4-10](#) appears.



Figure 4-3-4-9 : MSTI Port Configuration Page Screenshot

The page includes the following fields:

MSTI Port Configuration

| Object | Description |
|--|---|
| <ul style="list-style-type: none"> • Select MSTI | Select the bridge instance and set more detail configuration. |

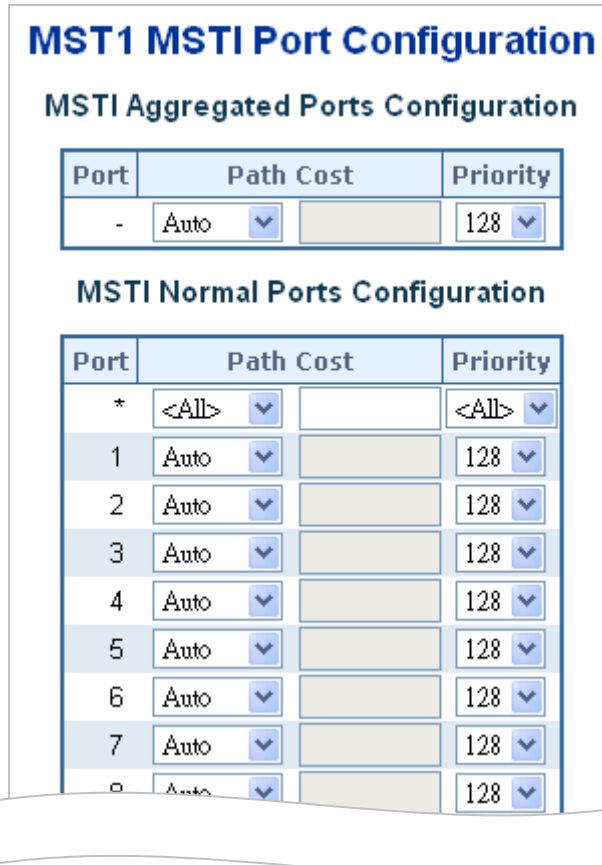

Figure 4-3-4-10 : MST1 MSTI Port Configuration Page Screenshot

The page includes the following fields:

MSTx MSTI Port Configuration

| Object | Description |
|---|--|
| <ul style="list-style-type: none"> • Port | The switch port number of the corresponding STP CIST (and MSTI) port. |
| <ul style="list-style-type: none"> • Path Cost | Controls the path cost incurred by the port. The Auto setting will set the path cost as appropriate by the physical link speed, using the 802.1D recommended values. Using the Specific setting, a user-defined value can be entered. The path cost is used when establishing the active topology of the network. Lower path cost ports are chosen as forwarding ports in favor of higher path cost ports. Valid values are in the range 1 to 200000000. |
| <ul style="list-style-type: none"> • Priority | Controls the port priority. This can be used to control priority of ports having identical port cost. |

Buttons

Get : Click to set MSTx configuration

Apply : Click to apply changes

Reset : Click to undo any changes made locally and revert to previously saved values.

4.3.4.8 Port Status

This page displays the STP CIST port status for port physical ports in the currently selected switch.

The STP Port Status screen in [Figure 4-3-4-11](#) appears.

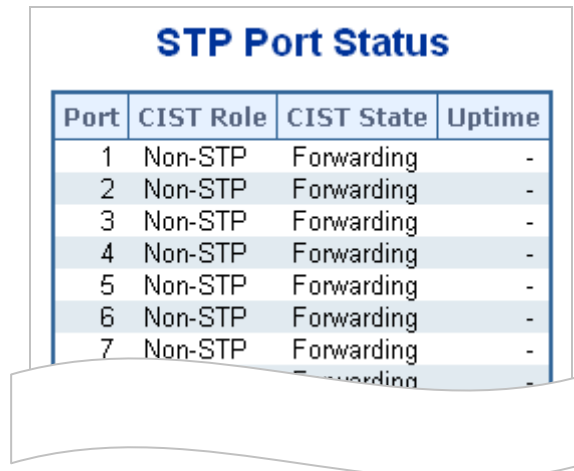

| Port | CIST Role | CIST State | Uptime |
|------|-----------|------------|--------|
| 1 | Non-STP | Forwarding | - |
| 2 | Non-STP | Forwarding | - |
| 3 | Non-STP | Forwarding | - |
| 4 | Non-STP | Forwarding | - |
| 5 | Non-STP | Forwarding | - |
| 6 | Non-STP | Forwarding | - |
| 7 | Non-STP | Forwarding | - |

Figure 4-3-4-11: STP Port Status Page Screenshot

The page includes the following fields:

| Object | Description |
|---|---|
| <ul style="list-style-type: none"> • Port | The switch port number of the logical STP port. |
| <ul style="list-style-type: none"> • CIST Role | The current STP port role of the ICST port. The port role can be one of the following values: <ul style="list-style-type: none"> ■ AlternatePort ■ BackupPort ■ RootPort ■ DesignatedPort ■ Disable |
| <ul style="list-style-type: none"> • CIST State | The current STP port state of the CIST port . The port state can be one of the following values: <ul style="list-style-type: none"> ■ Disabled ■ Learning ■ Forwarding |
| <ul style="list-style-type: none"> • Uptime | The time since the bridge port was last initialized. |

Buttons

: Click to refresh the page immediately.

Auto-refresh : Check this box to refresh the page automatically. Automatic refresh occurs every 3 seconds

4.3.4.9 Port Statistics

This page displays the STP port statistics counters for port physical ports in the currently selected switch.

The STP Port Statistics screen in [Figure 4-3-4-12](#) appears.

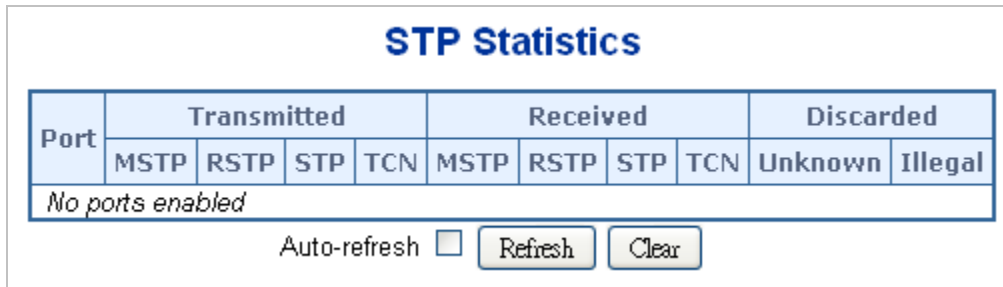

Figure 4-3-4-12: STP Statistics Page Screenshot

The page includes the following fields:

| Object | Description |
|----------------------------|--|
| • Port | The switch port number of the logical RSTP port. |
| • MSTP | The number of MSTP Configuration BPDU's received/transmitted on the port. |
| • RSTP | The number of RSTP Configuration BPDU's received/transmitted on the port. |
| • STP | The number of legacy STP Configuration BPDU's received/transmitted on the port. |
| • TCN | The number of (legacy) Topology Change Notification BPDU's received/transmitted on the port. |
| • Discarded Unknown | The number of unknown Spanning Tree BPDU's received (and discarded) on the port. |
| • Discarded Illegal | The number of illegal Spanning Tree BPDU's received (and discarded) on the port. |

Buttons

Auto-refresh Automatic refresh occurs every 3 seconds.

Refresh : Click to refresh the page immediately.

Clear : Clears the counters for all ports.

4.3.5 Multicast

4.3.5.1 IGMP Snooping

The **Internet Group Management Protocol (IGMP)** lets host and routers share information about multicast groups memberships. IGMP snooping is a switch feature that monitors the exchange of IGMP messages and copies them to the CPU for feature processing. The overall purpose of IGMP Snooping is to limit the forwarding of multicast frames to only ports that are a member of the multicast group.

About the Internet Group Management Protocol (IGMP) Snooping

Computers and network devices that want to receive multicast transmissions need to inform nearby routers that they will become members of a multicast group. The **Internet Group Management Protocol (IGMP)** is used to communicate this information. IGMP is also used to periodically check the multicast group for members that are no longer active. In the case where there is more than one multicast router on a sub network, one router is elected as the 'queried'. This router then keeps track of the membership of the multicast groups that have active members. The information received from IGMP is then used to determine if multicast packets should be forwarded to a given sub network or not. The router can check, using IGMP, to see if there is at least one member of a multicast group on a given subnet work. If there are no members on a sub network, packets will not be forwarded to that sub network.

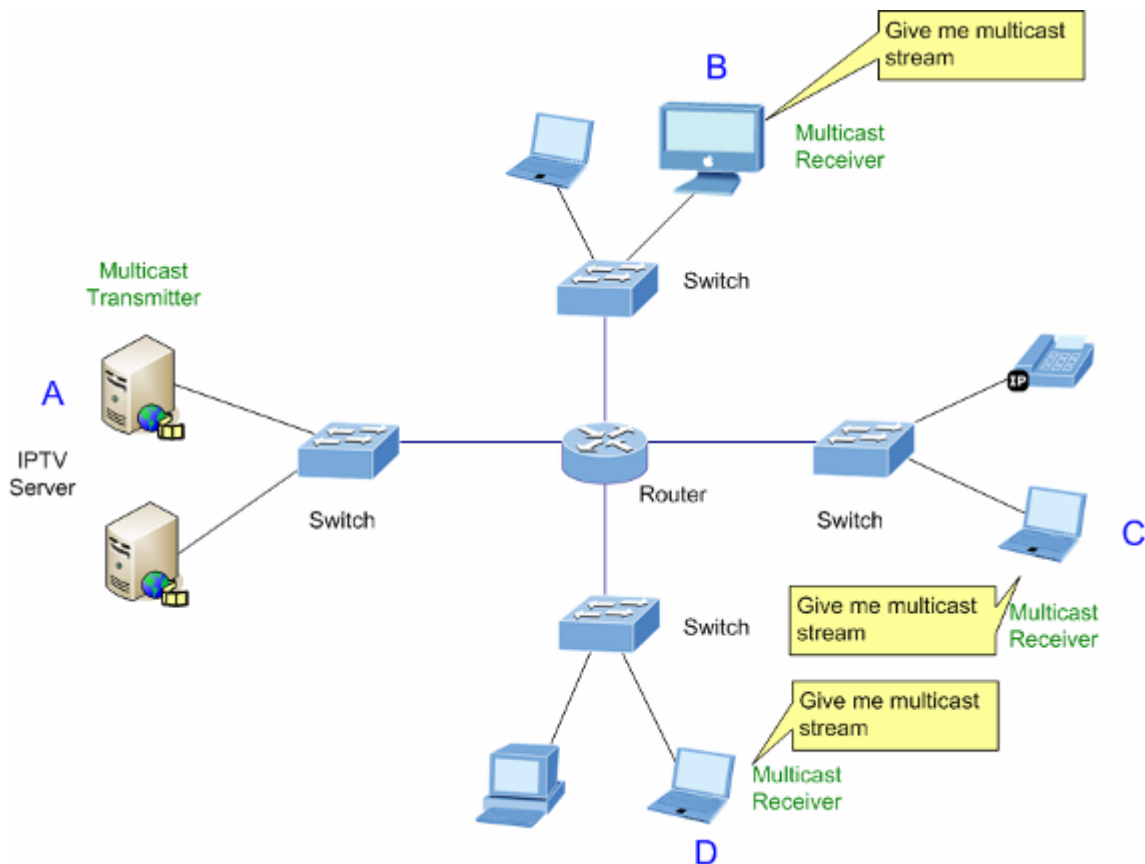

Figure 4-3-5-1: Multicast Service

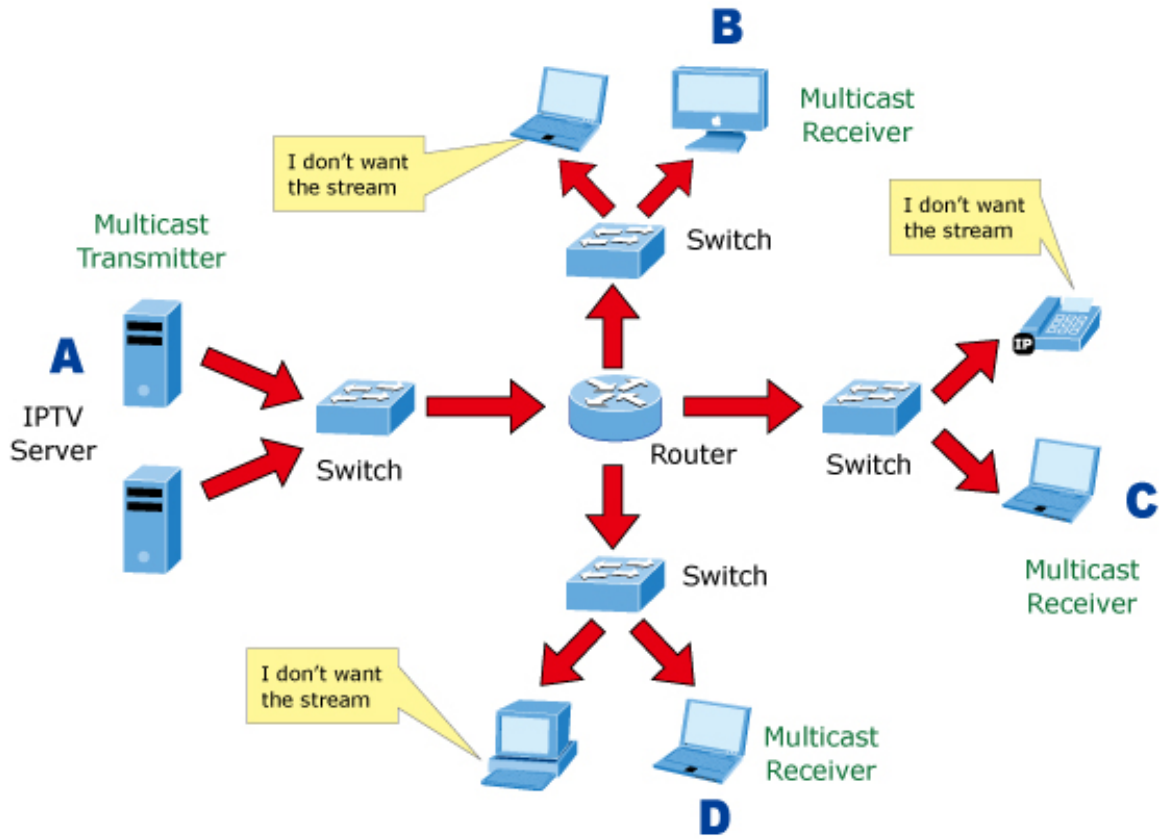

Figure 4-3-5-2: Multicast Flooding

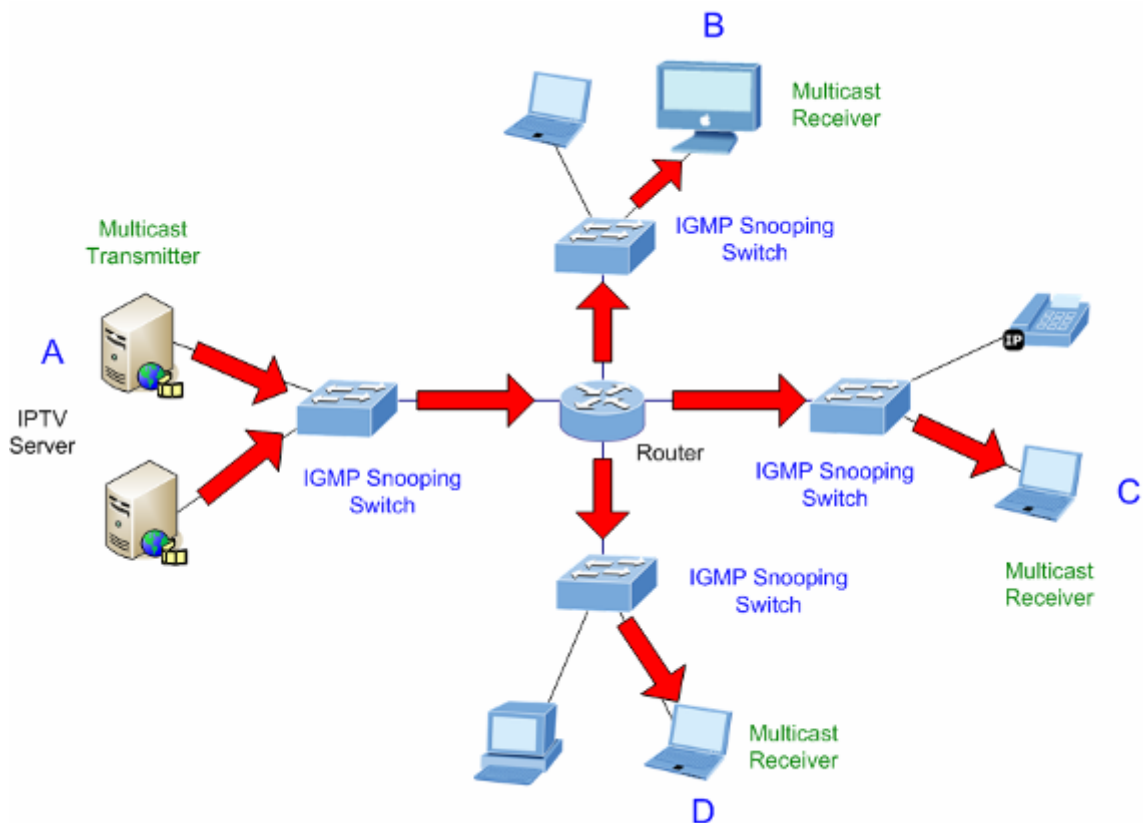

Figure 4-3-5-3: IGMP Snooping Multicast Stream Control

IGMP Versions 1 and 2

Multicast groups allow members to join or leave at any time. IGMP provides the method for members and multicast routers to communicate when joining or leaving a multicast group. IGMP version 1 is defined in RFC 1112. It has a fixed packet size and no optional data. The format of an IGMP packet is shown below:

IGMP Message Format

Octets

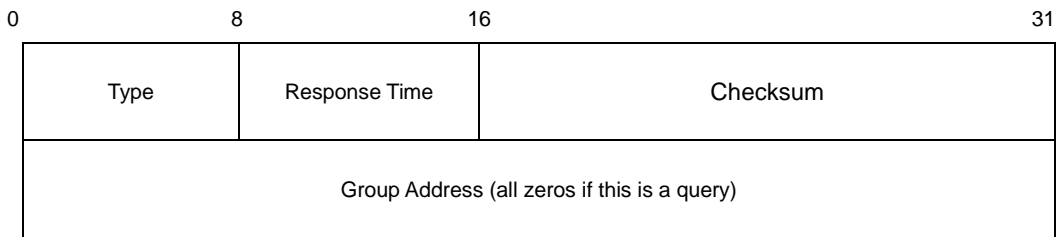

The IGMP Type codes are shown below:

| Type | Meaning |
|-------------|---|
| 0x11 | Membership Query (if Group Address is 0.0.0.0) |
| 0x11 | Specific Group Membership Query (if Group Address is Present) |
| 0x16 | Membership Report (version 2) |
| 0x17 | Leave a Group (version 2) |
| 0x12 | Membership Report (version 1) |

IGMP packets enable multicast routers to keep track of the membership of multicast groups, on their respective sub networks.

The following outlines what is communicated between a multicast router and a multicast group member using IGMP.

A host sends an IGMP “**report**” to join a group

A host will never send a report when it wants to leave a group (for version 1).

A host will send a “**leave**” report when it wants to leave a group (for version 2).

Multicast routers send IGMP queries (to the all-hosts group address: 224.0.0.1) periodically to see whether any group members exist on their sub networks. If there is no response from a particular group, the router assumes that there are no group members on the network.

The Time-to-Live (TTL) field of query messages is set to 1 so that the queries will not be forwarded to other sub networks.

IGMP version 2 introduces some enhancements such as a method to elect a multicast queried for each LAN, an explicit leave message, and query messages that are specific to a given group.

The states a computer will go through to join or to leave a multicast group are shown below:

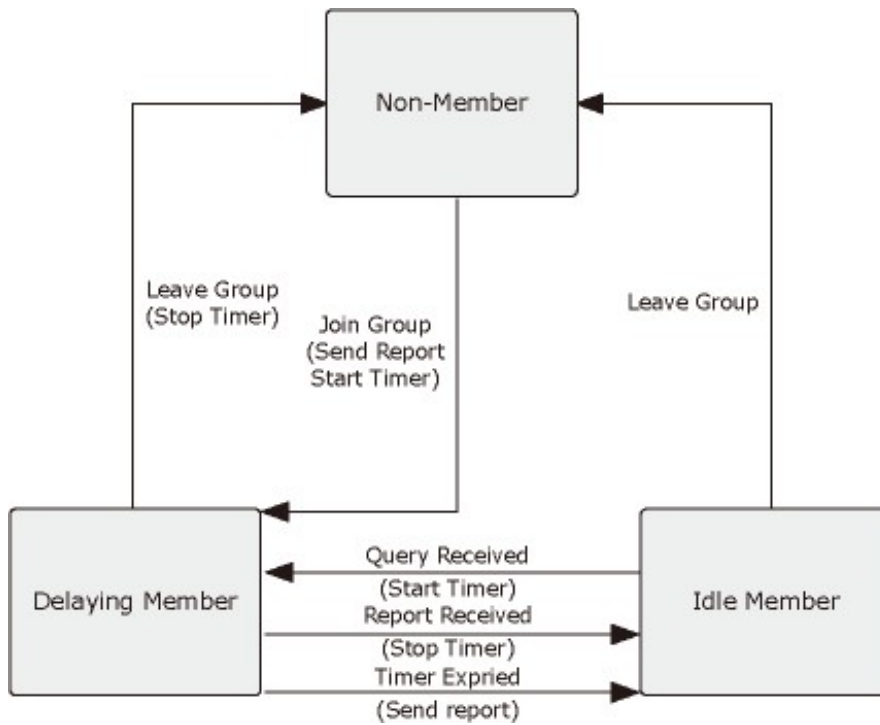
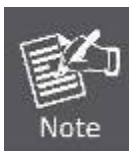

Figure 4-3-5-4: IGMP State Transitions

■ **IGMP Querier –**

A router, or multicast-enabled switch, can periodically ask their hosts if they want to receive multicast traffic. If there is more than one router/switch on the LAN performing IP multicasting, one of these devices is elected “**querier**” and assumes the role of querying the LAN for group members. It then propagates the service requests on to any upstream multicast switch/router to ensure that it will continue to receive the multicast service.



Multicast routers use this information, along with a multicast routing protocol such as DVMRP or PIM, to support IP multicasting across the Internet.

4.3.5.2 Profile Table

This page provides IPMC Profile related configurations. The IPMC profile is used to deploy the access control on IP multicast streams. It is allowed to create at maximum 64 Profiles with at maximum 128 corresponding rules for each. The Profile Table screen in Figure 4-3-5-5 appears.

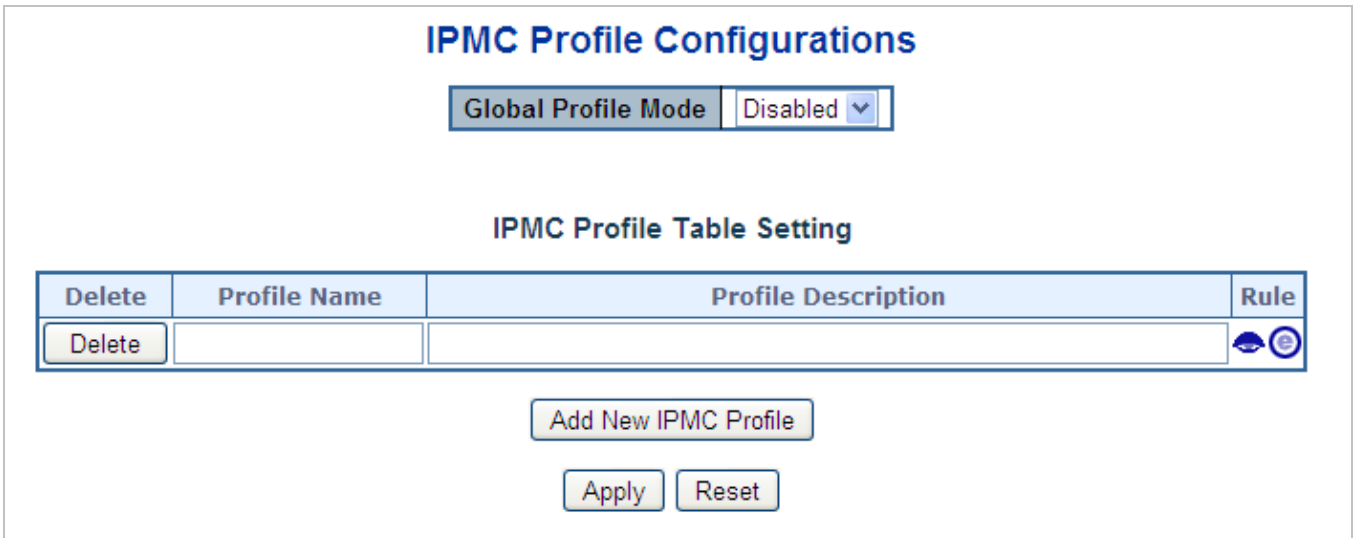

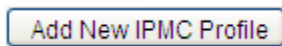

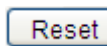

Figure 4-3-5-5: IPMC Profile Configuration Page

The page includes the following fields:

| Object | Description |
|--|---|
| <ul style="list-style-type: none"> • Global Profile Mode | <p>Enable/Disable the Global IPMC Profile.</p> <p>System starts to do filtering based on profile settings only when the global profile mode is enabled.</p> |
| <ul style="list-style-type: none"> • Delete | <p>Check to delete the entry.</p> <p>The designated entry will be deleted during the next save.</p> |
| <ul style="list-style-type: none"> • Profile Name | <p>The name used for indexing the profile table.</p> <p>Each entry has the unique name which is composed of at maximum 16 alphabetic and numeric characters. At least one alphabet must be present.</p> |
| <ul style="list-style-type: none"> • Profile Description | <p>Additional description, which is composed of at maximum 64 alphabetic and numeric characters, about the profile.</p> <p>No blank or space characters are permitted as part of description. Use "_" or "-" to separate the description sentence.</p> |
| <ul style="list-style-type: none"> • Rule | <p>When the profile is created, click the edit button to enter the rule setting page of the designated profile. Summary about the designated profile will be shown by clicking the view button. You can manage or inspect the rules of the designated profile by using the following buttons:</p> <p>: List the rules associated with the designated profile.</p> <p>: Adjust the rules associated with the designated profile.</p> |

Buttons

- : Click to add new IPMC profile. Specify the name and configure the new entry. Click "Save".
- : Click to apply changes
- : Click to undo any changes made locally and revert to previously saved values.

4.3.5.3 Address Entry

This page provides address range settings used in IPMC profile. The address entry is used to specify the address range that will be associated with IPMC Profile. It is allowed to create at maximum 128 address entries in the system. The Profile Table screen in Figure 4-3-5-6 appears.

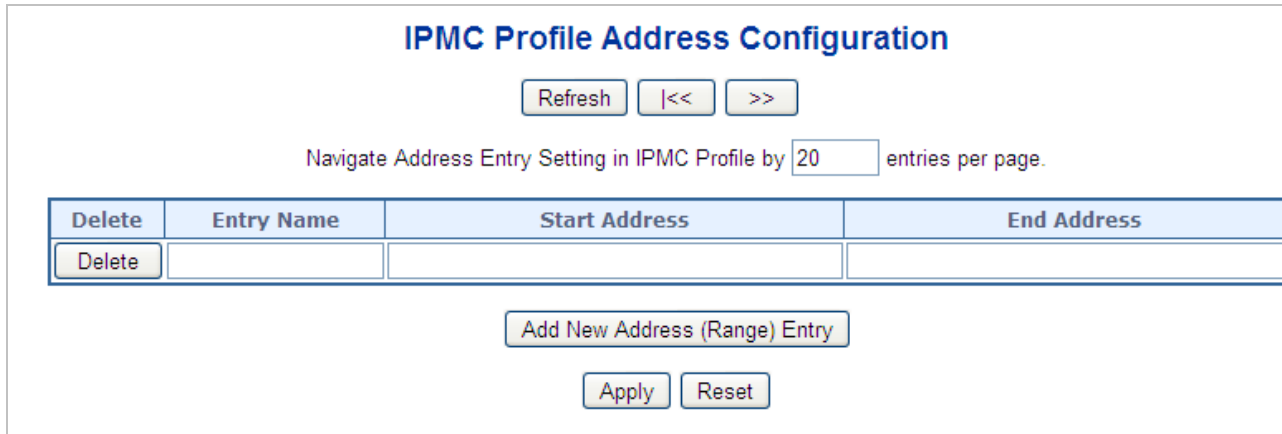

Figure 4-3-5-6: IPMC Profile Address Configuration Page

The page includes the following fields:

| Object | Description |
|--|---|
| <ul style="list-style-type: none"> • Delete | <p>Check to delete the entry.</p> <p>The designated entry will be deleted during the next save.</p> |
| <ul style="list-style-type: none"> • Entry Name | <p>The name used for indexing the address entry table.</p> <p>Each entry has the unique name which is composed of at maximum 16 alphabetic and numeric characters. At least one alphabet must be present.</p> |
| <ul style="list-style-type: none"> • Start Address | <p>The starting IPv4/IPv6 Multicast Group Address that will be used as an address range.</p> |
| <ul style="list-style-type: none"> • End Address | <p>The ending IPv4/IPv6 Multicast Group Address that will be used as an address range.</p> |

Buttons

Add New Address (Range) Entry: Click to add new address range. Specify the name and configure the addresses. Click "Save".

Apply: Click to apply changes

Reset: Click to undo any changes made locally and revert to previously saved values.

Refresh: Refreshes the displayed table starting from the input fields.

<<: Updates the table starting from the first entry in the IPMC Profile Address Configuration.

>>: Updates the table, starting with the entry after the last entry currently displayed.

4.3.5.4 IGMP Snooping Configuration

This page provides IGMP Snooping related configuration. The IGMP Snooping Configuration screen in [Figure 4-3-5-7](#) appears.

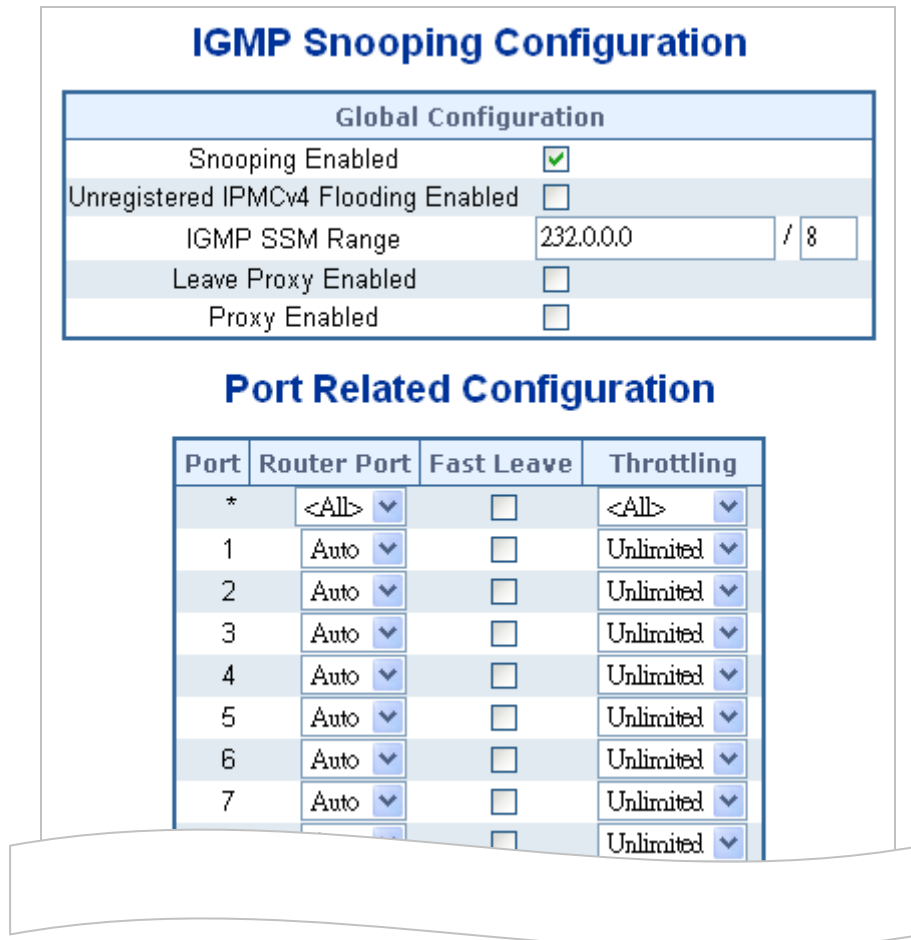



Figure 4-3-5-7: IGMP Snooping Configuration Page Screenshot

The page includes the following fields:

| Object | Description |
|---|--|
| • Snooping Enabled | Enable the Global IGMP Snooping. |
| • Unregistered IPMCv4 Flooding Enabled | Enable unregistered IPMCv4 traffic flooding. The flooding control takes effect only when IGMP Snooping is enabled. When IGMP Snooping is disabled, unregistered IPMCv4 traffic flooding is always active in spite of this setting. |
| • IGMP SSM Range | SSM (Source-Specific Multicast) Range allows the SSM-aware hosts and routers run the SSM service model for the groups in the address range. |
| • Leave Proxy Enable | Enable IGMP Leave Proxy. This feature can be used to avoid forwarding unnecessary leave messages to the router side. |
| • Proxy Enable | Enable IGMP Proxy. This feature can be used to avoid forwarding unnecessary join and leave messages to the router side. |
| • Router Port | Specify which ports act as IGMP router ports. A router port is a port on the |

| | |
|---|--|
| | <p>Ethernet switch that leads towards the Layer 3 multicast device or IGMP querier. The Switch forwards IGMP join or leave packets to an IGMP router port.</p> <ul style="list-style-type: none"> ■ Auto: Select "Auto" to have the Industrial Managed Switch automatically uses the port as IGMP Router port if the port receives IGMP query packets. ■ Fix: The Industrial Managed Switch always uses the specified port as an IGMP Router port. Use this mode when you connect an IGMP multicast server or IP camera which applied with multicast protocol to the port. ■ None: The Industrial Managed Switch will not use the specified port as an IGMP Router port. The Industrial Managed Switch will not keep any record of an IGMP router being connected to this port. Use this mode when you connect other IGMP multicast servers directly on the non-querier Industrial Managed Switch and don't want the multicast stream to be flooded by uplinking switch through the port that is connected to the IGMP querier. |
| <ul style="list-style-type: none"> • Fast Leave | <p>Enable the fast leave on the port.</p> |
| <ul style="list-style-type: none"> • Throtting | <p>Enable to limit the number of multicast groups to which a switch port can belong.</p> |

Buttons

 : Click to apply changes

 : Click to undo any changes made locally and revert to previously saved values.

4.3.5.5 IGMP Snooping VLAN Configuration

Each page shows up to 99 entries from the VLAN table, default being 20, selected through the "entries per page" input field. When first visited, the web page will show the first 20 entries from the beginning of the VLAN Table. The first displayed will be the one with the lowest VLAN ID found in the VLAN Table.

The "VLAN" input fields allow the user to select the starting point in the VLAN Table. The IGMP Snooping VLAN Configuration screen in [Figure 4-3-5-8](#) appears.



Figure 4-3-5-8: IGMP Snooping VLAN Configuration Page Screenshot

The page includes the following fields:

| Object | Description |
|-------------------------------|--|
| • Delete | Check to delete the entry. The designated entry will be deleted during the next save. |
| • VLAN ID | The VLAN ID of the entry. |
| • IGMP Snooping Enable | Enable the per-VLAN IGMP Snooping. Only up to 32 VLANs can be selected. |
| • Querier Election | Enable the IGMP Querier election in the VLAN. Disable to act as an IGMP Non-Querier. |
| • Querier Address | <p>Define the IPv4 address as source address used in IP header for IGMP Querier election.</p> <ul style="list-style-type: none"> ■ When the Querier address is not set, system uses IPv4 management address of the IP interface associated with this VLAN. ■ When the IPv4 management address is not set, system uses the first available IPv4 management address. Otherwise, system uses a pre-defined value. <p>By default, this value will be 192.0.2.1</p> |
| • Compatibility | <p>Compatibility is maintained by hosts and routers taking appropriate actions depending on the versions of IGMP operating on hosts and routers within a network. The allowed selection is IGMP-Auto, Forced IGMPv1, Forced IGMPv2, Forced IGMPv3.</p> <p>Default compatibility value is IGMP-Auto.</p> |
| • PRI | <p>(PRI) Priority of Interface. It indicates the IGMP control frame priority level generated by the system. These values can be used to prioritize different classes of traffic.</p> <p>The allowed range is 0 (best effort) to 7 (highest), default interface priority value is 0</p> |
| • RV | Robustness Variable. The Robustness Variable allows tuning for the expected packet loss on a network. |

| | |
|-------------------------------|---|
| | The allowed range is 1 to 255, default robustness variable value is 2. |
| • QI | Query Interval. The Query Interval is the interval between General Queries sent by the Querier. The allowed range is 1 to 31744 seconds, default query interval is 125 seconds. |
| • QRI | Query Response Interval. The Max Response Time used to calculate the Max Resp Code inserted into the periodic General Queries. The allowed range is 0 to 31744 in tenths of seconds, default query response interval is 100 in tenths of seconds (10 seconds). |
| • LLQI (LMQI for IGMP) | Last Member Query Interval. The Last Member Query Time is the time value represented by the Last Member Query Interval, multiplied by the Last Member Query Count. The allowed range is 0 to 31744 in tenths of seconds, default last member query interval is 10 in tenths of seconds (1 second). |
| • URI | Unsolicited Report Interval. The Unsolicited Report Interval is the time between repetitions of a host's initial report of membership in a group. The allowed range is 0 to 31744 seconds, default unsolicited report interval is 1 second. |

Buttons

 : Refreshes the displayed table starting from the "VLAN" input fields.

 : Updates the table starting from the first entry in the VLAN Table, i.e. the entry with the lowest VLAN ID.

 : Updates the table, starting with the entry after the last entry currently displayed.

 : Click to add new IGMP VLAN. Specify the VID and configure the new entry.

Click "Save". The specific IGMP VLAN starts working after the corresponding static VLAN is also created.

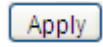
 : Click to apply changes

 : Click to undo any changes made locally and revert to previously saved values.

4.3.5.6 IGMP Snooping Port Group Filtering

In certain switch applications, the administrator may want to control the multicast services that are available to end users. For example, an IP/TV service based on a specific subscription plan. The IGMP filtering feature fulfills this requirement by restricting access to specified multicast services on a switch port, and IGMP throttling limits the number of simultaneous multicast groups a port can join.

IGMP filtering enables you to assign a profile to a switch port that specifies multicast groups that are permitted or denied on the

port. An IGMP filter profile can contain one or more, or a range of multicast addresses; but only one profile can be assigned to a port. When enabled, IGMP join reports received on the port are checked against the filter profile. If a requested multicast group is permitted, the IGMP join report is forwarded as normal. If a requested multicast group is denied, the IGMP join report is dropped.

IGMP throttling sets a maximum number of multicast groups that a port can join at the same time. When the maximum number of groups is reached on a port, the switch can take one of two actions; either “deny” or “replace”. If the action is set to deny, any new IGMP join reports will be dropped. If the action is set to replace, the switch randomly removes an existing group and replaces it with the new multicast group. The IGMP Snooping Port Group Filtering Configuration screen in [Figure 4-3-5-9](#) appears.

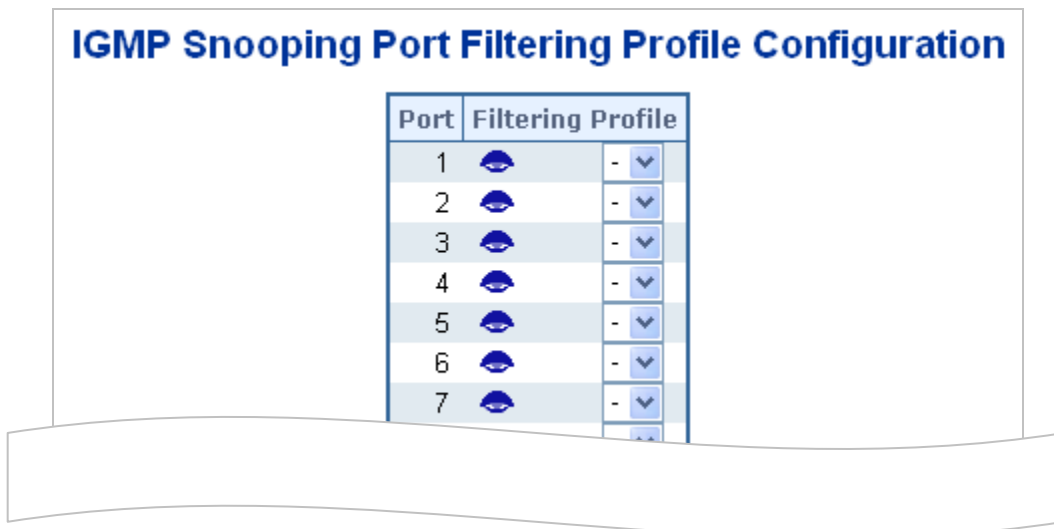



Figure 4-3-5-9: IGMP Snooping Port Filtering Profile Configuration Page Screenshot

The page includes the following fields:

| Object | Description |
|---|--|
| <ul style="list-style-type: none"> Port | The logical port for the settings. |
| <ul style="list-style-type: none"> Filtering Profile | Select the IPMC Profile as the filtering condition for the specific port. Summary about the designated profile will be shown by clicking the view button |

Buttons

 : Click to apply changes

 : Click to undo any changes made locally and revert to previously saved values.

4.3.5.7 IGMP Snooping Status

This page provides IGMP Snooping status. The IGMP Snooping Status screen in [Figure 4-3-5-10](#) appears.

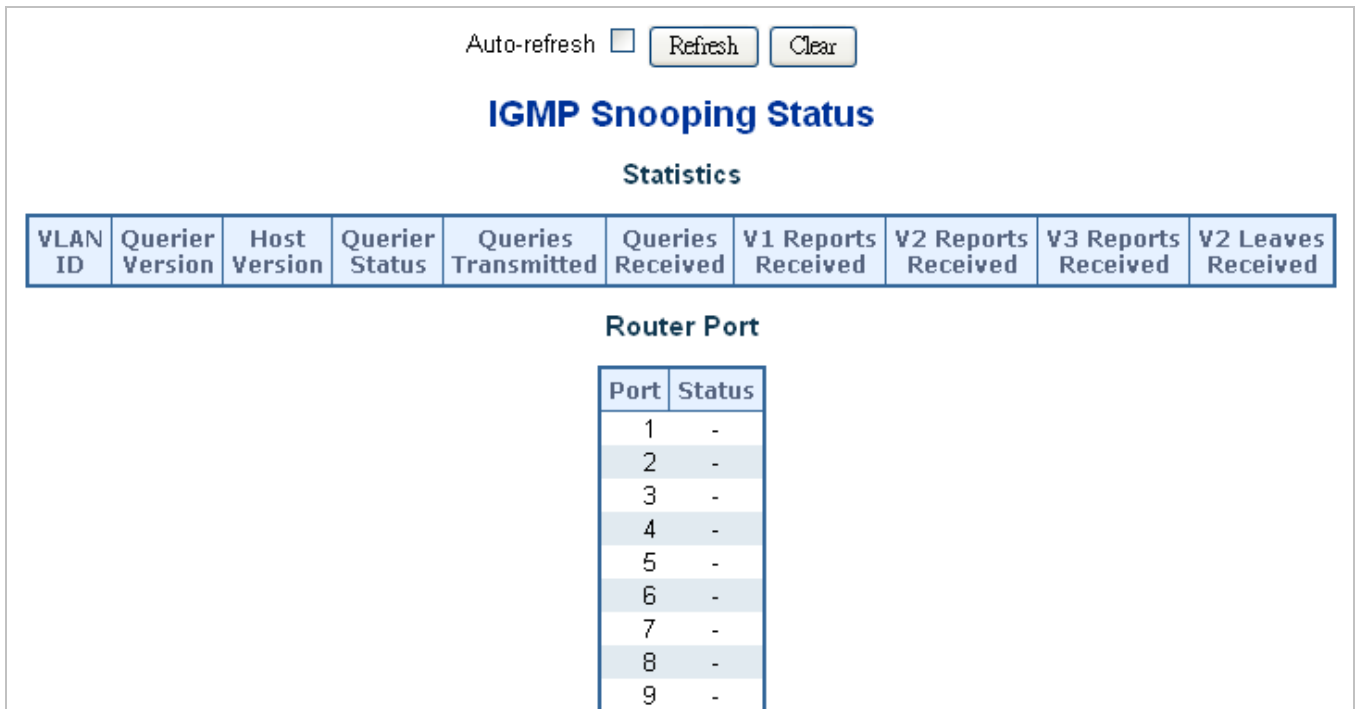

Figure 4-3-5-10: IGMP Snooping Status Page Screenshot

The page includes the following fields:

| Object | Description |
|------------------------------|---|
| • VLAN ID | The VLAN ID of the entry. |
| • Querier Version | Working Querier Version currently. |
| • Host Version | Working Host Version currently. |
| • Querier Status | Show the Querier status is "ACTIVE" or "IDLE". |
| • Querier Transmitted | The number of Transmitted Querier. |
| • Querier Received | The number of Received Querier. |
| • V1 Reports Received | The number of Received V1 Reports. |
| • V2 Reports Received | The number of Received V2 Reports. |
| • V3 Reports Received | The number of Received V3 Reports. |
| • V2 Leave Received | The number of Received V2 Leave. |
| • Router Port | Display which ports act as router ports. A router port is a port on the Ethernet switch that leads towards the Layer 3 multicast device or IGMP querier. Static denotes the specific port is configured to be a router port. Dynamic denotes the specific port is learnt to be a router port. Both denote the specific port is configured or learnt to be a router port. |
| • Port | Switch port number. |
| • Status | Indicate whether specific port is a router port or not. |

Buttons

Refresh: Click to refresh the page immediately.

: Clears all Statistics counters.

Auto-refresh : Automatic refresh occurs every 3 seconds.

4.3.5.8 IGMP Group Information

Entries in the IGMP Group Table are shown on this Page. The IGMP Group Table is sorted first by VLAN ID, and then by group. Each page shows up to 99 entries from the IGMP Group table, default being 20, selected through the "entries per page" input field. When first visited, the web page will show the first 20 entries from the beginning of the IGMP Group Table. The "Start from VLAN", and "group" input fields allow the user to select the starting point in the IGMP Group Table. The IGMP Groups Information screen in [Figure 4-3-5-11](#) appears.

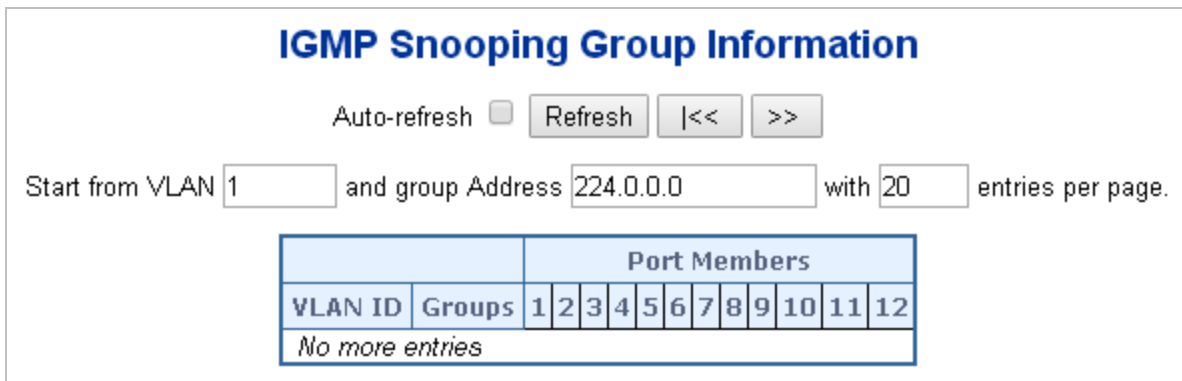

Figure 4-3-5-11: IGMP Snooping Groups Information Page Screenshot

The page includes the following fields:

| Object | Description |
|-----------------------|---------------------------------------|
| • VLAN ID | VLAN ID of the group. |
| • Groups | Group address of the group displayed. |
| • Port Members | Ports under this group. |

Buttons

Auto-refresh : Automatic refresh occurs every 3 seconds.

: Refreshes the displayed table starting from the input fields.

: Updates the table, starting with the first entry in the IGMP Group Table.

: Updates the table, starting with the entry after the last entry currently displayed.

4.3.6 MLD Snooping

4.3.6.1 MLD Snooping Configuration

This page provides MLD Snooping related configuration. The MLD Snooping Configuration screen in [Figure 4-3-6-1](#) appears.

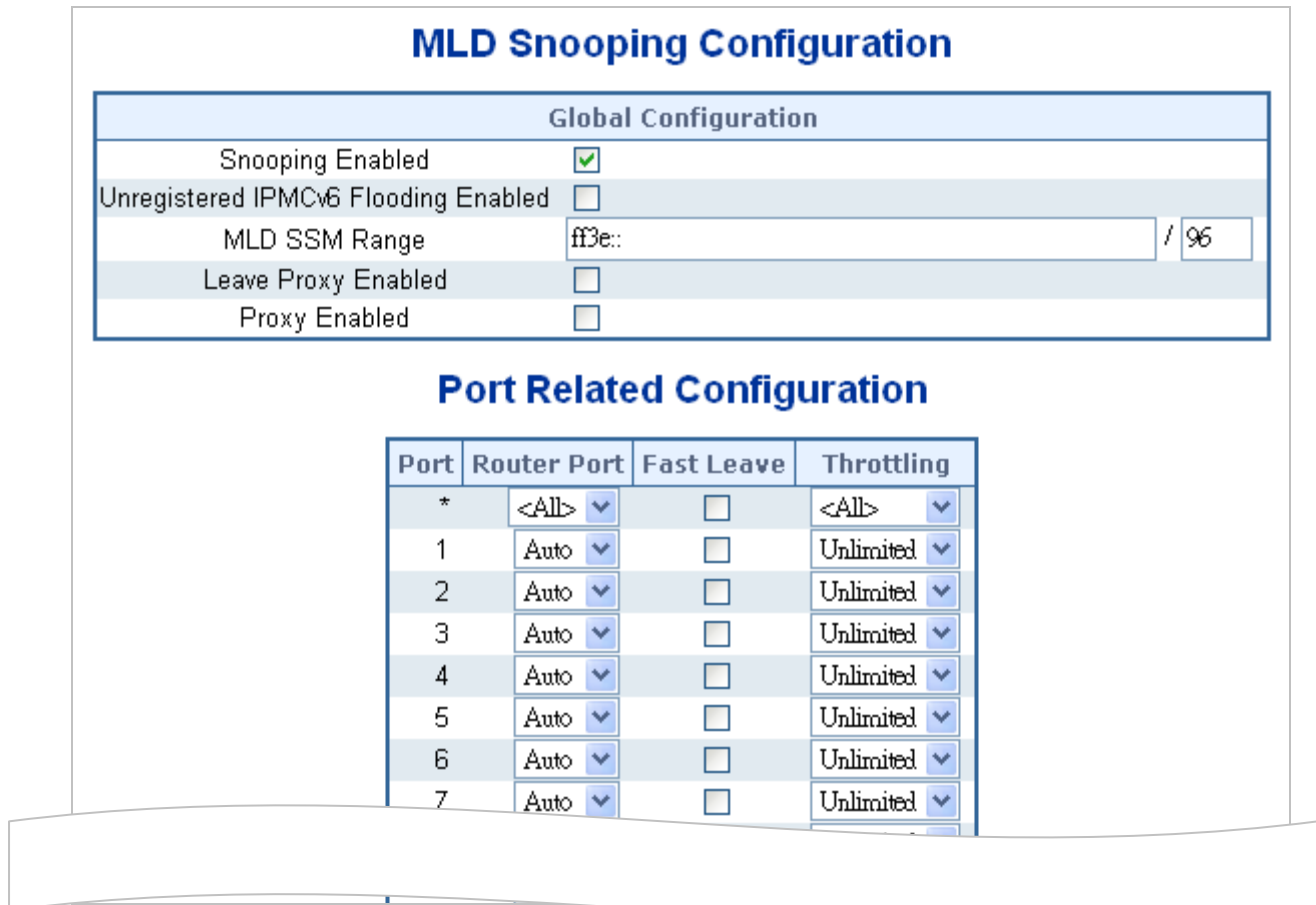



Figure 4-3-6-1: MLD Snooping Configuration Page Screenshot

The page includes the following fields:

| Object | Description |
|---|--|
| • Snooping Enabled | Enable the Global MLD Snooping. |
| • Unregistered IPMCv6 Flooding enabled | Enable unregistered IPMCv6 traffic flooding. The flooding control takes effect only when MLD Snooping is enabled. When MLD Snooping is disabled, unregistered IPMCv6 traffic flooding is always active in spite of this setting. |
| • MLD SSM Range | SSM (Source-Specific Multicast) Range allows the SSM-aware hosts and routers run the SSM service model for the groups in the address range. |
| • Leave Proxy Enable | Enable MLD Leave Proxy. This feature can be used to avoid forwarding unnecessary leave messages to the router side. |

| | |
|---|--|
| <ul style="list-style-type: none"> • Proxy Enable | Enable MLD Proxy. This feature can be used to avoid forwarding unnecessary join and leave messages to the router side. |
| <ul style="list-style-type: none"> • Router Port | Specify which ports act as router ports. A router port is a port on the Ethernet switch that leads towards the Layer 3 multicast device or MLD querier. If an aggregation member port is selected as a router port, the whole aggregation will act as a router port. The allowed selection is Auto , Fix , None , default compatibility value is Auto. |
| <ul style="list-style-type: none"> • Fast Leave | Enable the fast leave on the port. |
| <ul style="list-style-type: none"> • Throtting | Enable to limit the number of multicast groups to which a switch port can belong. |

Buttons

 : Click to apply changes

 : Click to undo any changes made locally and revert to previously saved values.

4.3.6.2 MLD Snooping VLAN Configuration

Each page shows up to 99 entries from the VLAN table, default being 20, selected through the "entries per page" input field. When first visited, the web page will show the first 20 entries from the beginning of the VLAN Table. The first displayed will be the one with the lowest VLAN ID found in the VLAN Table.

The "VLAN" input fields allow the user to select the starting point in the VLAN Table. The MLD Snooping VLAN Configuration screen in [Figure 4-3-6-2](#) appears.

MLD Snooping VLAN Configuration

Start from VLAN with entries per page.

| VLAN ID | Snooping Enabled | Querier Election | Compatibility | PRI | RV | QI (sec) | QRI (0.1 sec) | LLQI (0.1 sec) | URI (sec) |
|---------|--------------------------|--------------------------|---------------|-----|----|----------|---------------|----------------|-----------|
| 1 | <input type="checkbox"/> | <input type="checkbox"/> | MLD-Auto ▾ | 0 ▾ | 2 | 125 | 100 | 10 | 1 |

Figure 4-3-6-2: IGMP Snooping VLAN Configuration Page Screenshot

The page includes the following fields:

| Object | Description |
|---|---|
| <ul style="list-style-type: none"> • Delete | Check to delete the entry. The designated entry will be deleted during the next save. |

| | |
|-------------------------------|--|
| • VLAN ID | The VLAN ID of the entry. |
| • MLD Snooping Enable | Enable the per-VLAN MLD Snooping. Up to 32 VLANs can be selected for MLD Snooping. |
| • Querier Election | Enable to join MLD Querier election in the VLAN. Disable to act as a MLD Non-Querier. |
| • Compatibility | Compatibility is maintained by hosts and routers taking appropriate actions depending on the versions of MLD operating on hosts and routers within a network. The allowed selection is MLD-Auto , Forced MLDv1 , Forced MLDv2 , default compatibility value is MLD-Auto. |
| • PRI | (PRI) Priority of Interface. It indicates the MLD control frame priority level generated by the system. These values can be used to prioritize different classes of traffic. The allowed range is 0 (best effort) to 7 (highest), default interface priority value is 0 |
| • RV | Robustness Variable. The Robustness Variable allows tuning for the expected packet loss on a network. The allowed range is 1 to 255 , default robustness variable value is 2 . |
| • QI | Query Interval. The Query Interval is the interval between General Queries sent by the Querier. The allowed range is 1 to 31744 seconds, default query interval is 125 seconds. |
| • QRI | Query Response Interval. The Max Response Time used to calculate the Max Resp Code inserted into the periodic General Queries. The allowed range is 0 to 31744 in tenths of seconds, default query response interval is 100 in tenths of seconds (10 seconds). |
| • LLQI (LMQI for IGMP) | Last Member Query Interval. The Last Member Query Time is the time value represented by the Last Member Query Interval, multiplied by the Last Member Query Count. The allowed range is 0 to 31744 in tenths of seconds, default last member query interval is 10 in tenths of seconds (1 second). |
| • URI | Unsolicited Report Interval. The Unsolicited Report Interval is the time between repetitions of a host's initial report of membership in a group. The allowed range is 0 to 31744 seconds, default unsolicited report interval is 1 second. |

Buttons

: Refreshes the displayed table starting from the "VLAN" input fields.

: Updates the table starting from the first entry in the VLAN Table, i.e. the entry with the lowest VLAN ID.

: Updates the table, starting with the entry after the last entry currently displayed.

: Click to add new MLD VLAN. Specify the VID and configure the new entry.

Click "Save". The specific MLD VLAN starts working after the corresponding static VLAN is also created.

Apply : Click to apply changes

Reset : Click to undo any changes made locally and revert to previously saved values.

4.3.6.3 MLD Snooping Port Group Filtering

In certain switch applications, the administrator may want to control the multicast services that are available to end users. For example, an IP/TV service based on a specific subscription plan. The MLD filtering feature fulfills this requirement by restricting access to specified multicast services on a switch port, and MLD throttling limits the number of simultaneous multicast groups a port can join.

MLD filtering enables you to assign a profile to a switch port that specifies multicast groups that are permitted or denied on the port. A MLD filter profile can contain one or more, or a range of multicast addresses; but only one profile can be assigned to a port. When enabled, MLD join reports received on the port are checked against the filter profile. If a requested multicast group is permitted, the MLD join report is forwarded as normal. If a requested multicast group is denied, the MLD join report is dropped.

MLD throttling sets a maximum number of multicast groups that a port can join at the same time. When the maximum number of groups is reached on a port, the switch can take one of two actions; either “deny” or “replace”. If the action is set to deny, any new MLD join reports will be dropped. If the action is set to replace, the switch randomly removes an existing group and replaces it with the new multicast group. The MLD Snooping Port Group Filtering Configuration screen in [Figure 4-3-6-3](#) appears.

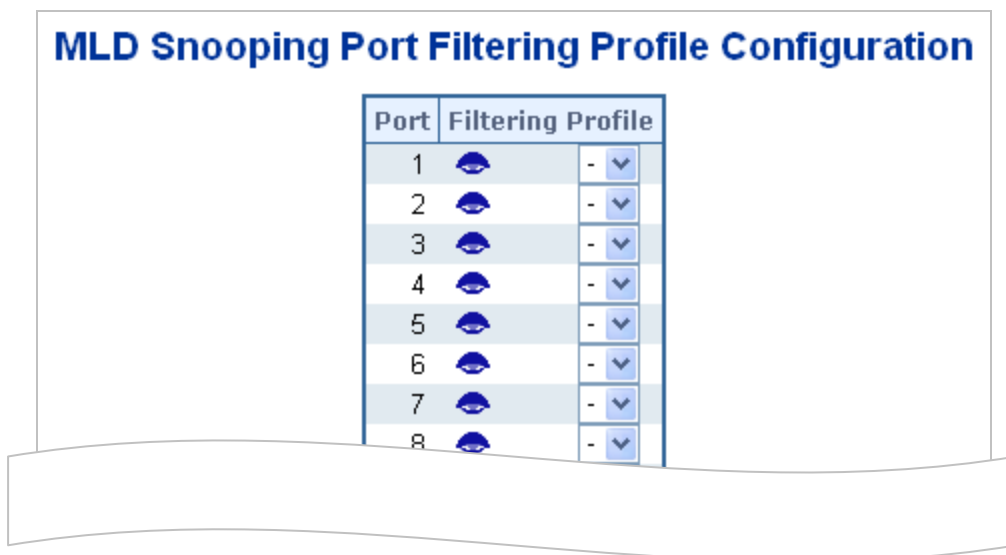

Figure 4-3-6-3: MLD Snooping Port Group Filtering Configuration Page Screenshot

The page includes the following fields:

| Object | Description |
|--|---|
| <ul style="list-style-type: none"> • Port | The logical port for the settings. |
| <ul style="list-style-type: none"> • Filtering Group | Select the IPMC Profile as the filtering condition for the specific port. Summary about the designated profile will be shown by clicking the view button. |

Buttons

Apply : Click to apply changes

Reset : Click to undo any changes made locally and revert to previously saved values.

4.3.6.4 MLD Snooping Status

This page provides MLD Snooping status. The IGMP Snooping Status screen in [Figure 4-3-6-4](#) appears.

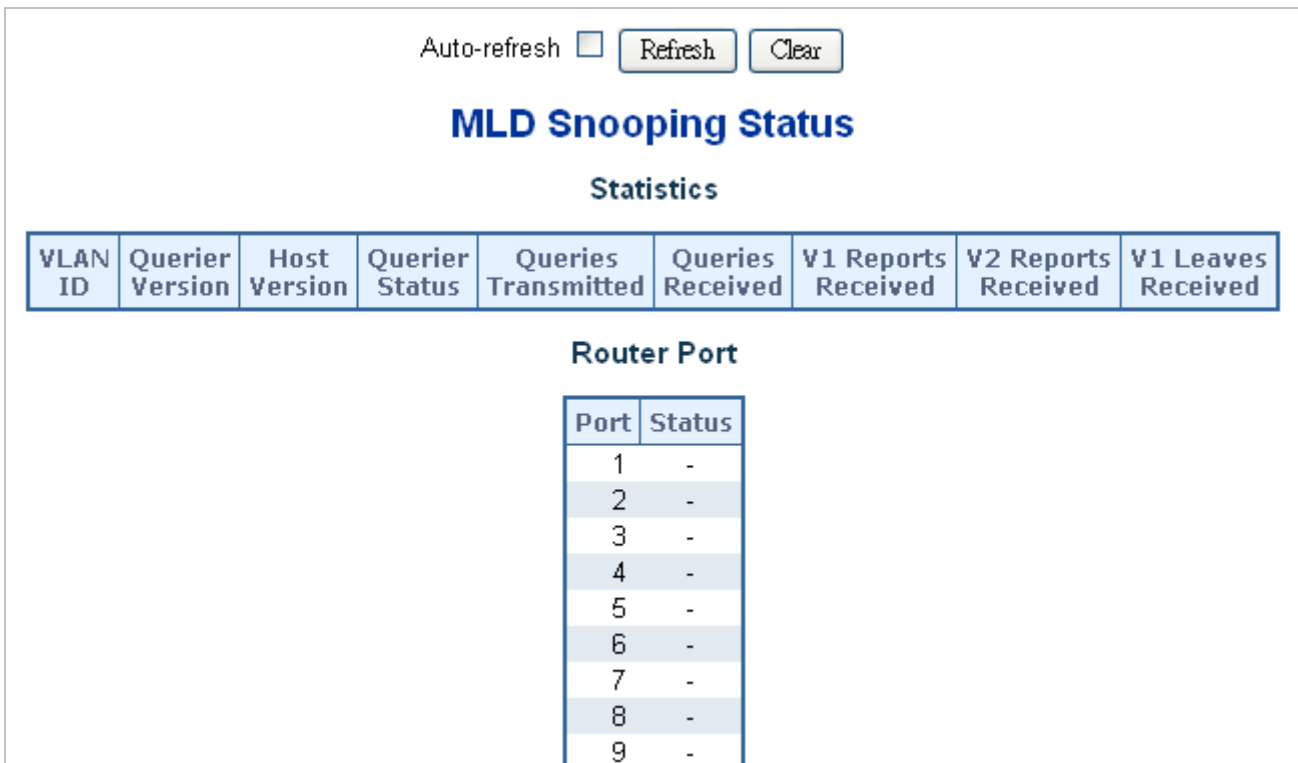

Figure 4-3-6-4: MLD Snooping Status Page Screenshot

The page includes the following fields:

| Object | Description |
|------------------------------|---|
| • VLAN ID | The VLAN ID of the entry. |
| • Querier Version | Working Querier Version currently. |
| • Host Version | Working Host Version currently. |
| • Querier Status | Shows the Querier status is "ACTIVE" or "IDLE". "DISABLE" denotes the specific interface is administratively disabled. |
| • Querier Transmitted | The number of Transmitted Querier. |
| • Querier Received | The number of Received Querier. |
| • V1 Reports Received | The number of Received V1 Reports. |
| • V2 Reports Received | The number of Received V2 Reports. |

| | |
|----------------------------|--|
| • V1 Leave Received | The number of Received V1 Leaves. |
| • Router Port | Display which ports act as router ports. A router port is a port on the Ethernet switch that leads towards the Layer 3 multicast device or MLD querier. Static denotes the specific port is configured to be a router port. Dynamic denotes the specific port is learnt to be a router port. Both denote the specific port is configured or learnt to be a router port. |
| • Port | Switch port number. |
| • Status | Indicates whether specific port is a router port or not. |

Buttons

: Click to refresh the page immediately.

: Clears all Statistics counters.

Auto-refresh : Automatic refresh occurs every 3 seconds.

4.3.6.5 MLD Group Information

Entries in the MLD Group Table are shown on this page. The MLD Group Table is sorted first by VLAN ID, and then by group. Each page shows up to 99 entries from the MLD Group table, default being 20, selected through the "entries per page" input field. When first visited, the web page will show the first 20 entries from the beginning of the MLD Group Table.

The "Start from VLAN", and "group" input fields allow the user to select the starting point in the MLD Group Table. The MLD Groups Information screen in [Figure 4-3-6-5](#) appears.

MLD Snooping Group Information

Auto-refresh

Start from VLAN and group Address with entries per page.

| | | Port Members | | | | | | | | | | | |
|-----------------|--------|--------------|---|---|---|---|---|---|---|---|----|----|----|
| VLAN ID | Groups | 1 | 2 | 3 | 4 | 5 | 6 | 7 | 8 | 9 | 10 | 11 | 12 |
| No more entries | | | | | | | | | | | | | |

Figure 4-3-6-5: MLD Snooping Groups Information Page Screenshot

The page includes the following fields:

| Object | Description |
|-----------------------|---------------------------------------|
| • VLAN ID | VLAN ID of the group. |
| • Groups | Group address of the group displayed. |
| • Port Members | Ports under this group. |

Buttons

Auto-refresh : Automatic refresh occurs every 3 seconds.

: Click to refresh the page immediately.

: Updates the table, starting with the first entry in the IGMP Group Table.

: Updates the table, starting with the entry after the last entry currently displayed.

4.3.6.6 MLDv2 Information

Entries in the MLD SFM Information Table are shown on this page. The MLD SFM (Source-Filtered Multicast) Information Table also contains the SSM (Source-Specific Multicast) information. This table is sorted first by VLAN ID, then by group, and then by Port. Different source addresses belong to the same group are treated as single entry. Each page shows up to 99 entries from the MLD SFM Information table, default being 20, selected through the "entries per page" input field. When first visited, the web Page will show the first 20 entries from the beginning of the MLD SFM Information Table.

The "Start from VLAN", and "group" input fields allow the user to select the starting point in the MLD SFM Information Table. The MLDv2 Information screen in [Figure 4-3-6-6](#) appears.



Figure 4-3-6-6: MLD SSM Information Page Screenshot

The page includes the following fields:

| Object | Description |
|------------------|---------------------------------------|
| • VLAN ID | VLAN ID of the group. |
| • Group | Group address of the group displayed. |
| • Port | Switch port number. |

| | |
|---|---|
| <ul style="list-style-type: none"> • Mode | Indicates the filtering mode maintained per (VLAN ID, port number, Group Address) basis. It can be either Include or Exclude. |
| <ul style="list-style-type: none"> • Source Address | IP Address of the source. Currently, system limits the total number of IP source addresses for filtering to be 128. |
| <ul style="list-style-type: none"> • Type | Indicates the Type. It can be either Allow or Deny. |
| <ul style="list-style-type: none"> • Hardware Filter/Switch | Indicates whether data plane destined to the specific group address from the source IPv6 address could be handled by chip or not. |

Buttons

Auto-refresh : Automatic refresh occurs every 3 seconds.

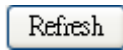
: Refreshes the displayed table starting from the input fields.

: Updates the table starting from the first entry in the MLD SFM Information Table.

: Updates the table, starting with the entry after the last entry currently displayed.

4.3.7 MVR (Multicast VLAN Registration)

The MVR feature enables multicast traffic forwarding on the Multicast VLANs.

- In a multicast television application, a PC or a network television or a set-top box can receive the multicast stream.
- Multiple set-top boxes or PCs can be connected to one subscriber port, which is a switch port configured as an MVR receiver port. When a subscriber selects a channel, the set-top box or PC sends an IGMP/MLD report message to Switch A to join the appropriate multicast group address.
- Uplink ports that send and receive multicast data to and from the multicast VLAN are called MVR source ports.

It is allowed to create at maximum 8 MVR VLANs with corresponding channel settings for each Multicast VLAN. There will be totally at maximum 256 group addresses for channel settings.

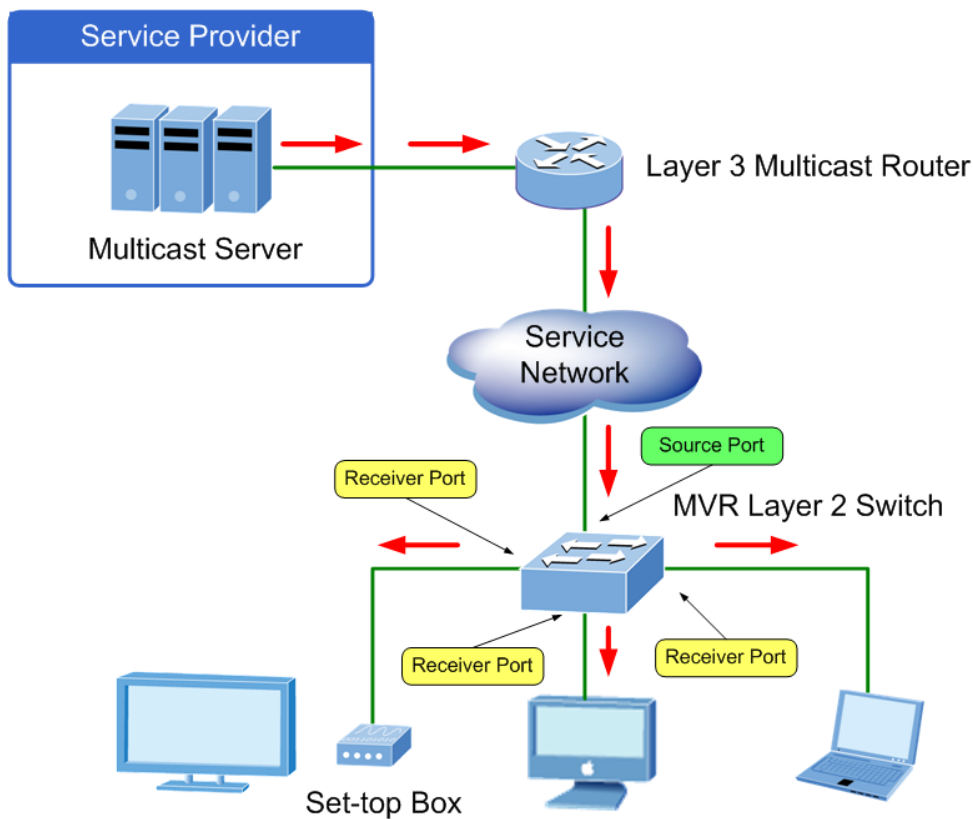

4.3.7.1 MVR Configuration

. This page provides MVR related configuration. The MVR screen in [Figure 4-3-7-1](#) appears

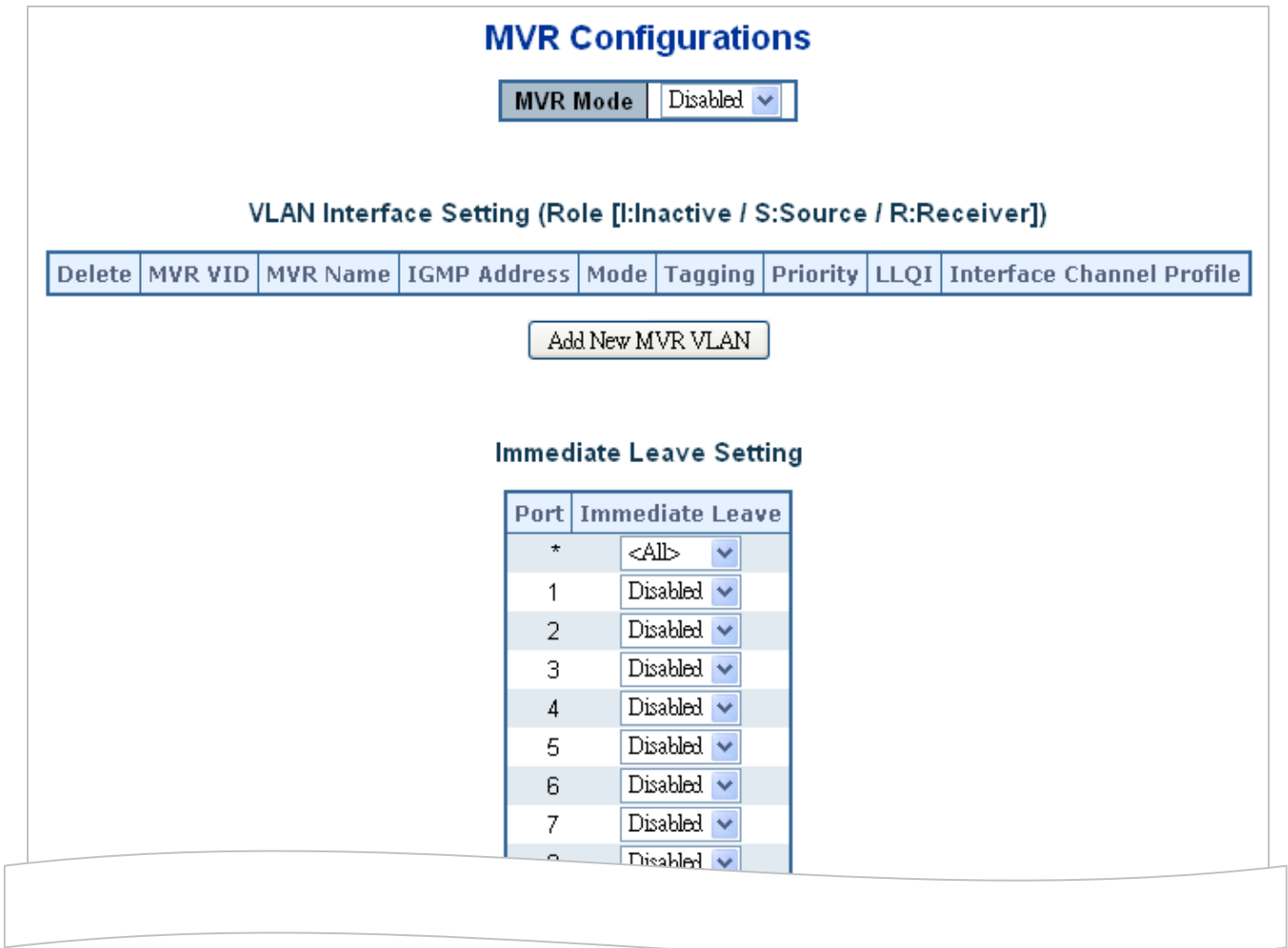

Figure 4-3-7-1: MVR Configuration Page Screenshot

The page includes the following fields:

| Object | Description |
|---|--|
| <ul style="list-style-type: none"> MVR Mode | <p>Enable/Disable the Global MVR.</p> <p>The Unregistered Flooding control depends on the current configuration in IGMP/MLD Snooping.</p> <p>It is suggested to enable Unregistered Flooding control when the MVR group table is full.</p> |
| <ul style="list-style-type: none"> Delete | <p>Check to delete the entry. The designated entry will be deleted during the next save.</p> |
| <ul style="list-style-type: none"> MVR VID | <p>Specify the Multicast VLAN ID.</p> <p>Be Caution: MVR source ports are not recommended to be overlapped with management VLAN ports.</p> |
| <ul style="list-style-type: none"> MVR Name | <p>MVR Name is an optional attribute to indicate the name of the specific MVR VLAN. Maximum length of the MVR VLAN Name string is 16. MVR VLAN Name can only contain alphabets or numbers. When the optional MVR VLAN name is</p> |

| | |
|--|--|
| | <p>given, it should contain at least one alphabet. MVR VLAN name can be edited for the existing MVR VLAN entries or it can be added to the new entries.</p> |
| <ul style="list-style-type: none"> • IGMP Address | <p>Define the IPv4 address as source address used in IP header for IGMP control frames. The default IGMP address is not set (0.0.0.0).</p> <p>When the IGMP address is not set, system uses IPv4 management address of the IP interface associated with this VLAN.</p> <p>When the IPv4 management address is not set, system uses the first available IPv4 management address. Otherwise, system uses a pre-defined value. By default, this value will be 192.0.2.1.</p> |
| <ul style="list-style-type: none"> • Mode | <p>Specify the MVR mode of operation. In Dynamic mode, MVR allows dynamic MVR membership reports on source ports. In Compatible mode, MVR membership reports are forbidden on source ports. The default is Dynamic mode.</p> |
| <ul style="list-style-type: none"> • Tagging | <p>Specify whether the traversed IGMP/MLD control frames will be sent as Untagged or Tagged with MVR VID. The default is Tagged.</p> |
| <ul style="list-style-type: none"> • Priority | <p>Specify how the traversed IGMP/MLD control frames will be sent in prioritized manner. The default Priority is 0.</p> |
| <ul style="list-style-type: none"> • LLQI | <p>Define the maximum time to wait for IGMP/MLD report memberships on a receiver port before removing the port from multicast group membership. The value is in units of tenths of a seconds. The range is from 0 to 31744. The default LLQI is 5 tenths or one-half second.</p> |
| <ul style="list-style-type: none"> • Interface Channel Setting | <p>When the MVR VLAN is created, select the IPMC Profile as the channel filtering condition for the specific MVR VLAN. Summary about the Interface Channel Profiling (of the MVR VLAN) will be shown by clicking the view button. Profile selected for designated interface channel is not allowed to have overlapped permit group address.</p> |
| <ul style="list-style-type: none"> • Port | <p>The logical port for the settings.</p> |
| <ul style="list-style-type: none"> • Port Role | <p>Configure an MVR port of the designated MVR VLAN as one of the following roles.</p> <ul style="list-style-type: none"> ■ Inactive: The designated port does not participate MVR operations. ■ Source: Configure uplink ports that receive and send multicast data as source ports. Subscribers cannot be directly connected to source ports. ■ Receiver: Configure a port as a receiver port if it is a subscriber port and should only receive multicast data. It does not receive data unless it becomes a member of the multicast group by issuing IGMP/MLD messages. <p>Be Caution: MVR source ports are not recommended to be overlapped with management VLAN ports.</p> <p>Select the port role by clicking the Role symbol to switch the setting.</p> <p>I indicates Inactive; S indicates Source; R indicates Receiver</p> |

| | |
|--------------------------|------------------------------------|
| | The default Role is Inactive. |
| • Immediate Leave | Enable the fast leave on the port. |

Buttons

- Add New MVR VLAN** : Click to add new MVR VLAN. Specify the VID and configure the new entry. Click "Save"
- Apply** : Click to apply changes
- Reset** : Click to undo any changes made locally and revert to previously saved values.

4.3.7.2 MVR Status

This page provides MVR status. The MVR Status screen in [Figure 4-3-7-2](#) appears.

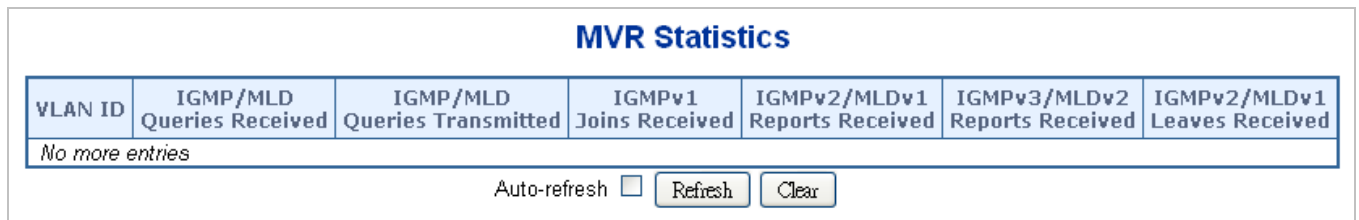

Figure 4-3-7-2: MVR Status Page Screenshot

The page includes the following fields:

| Object | Description |
|--|--|
| • VLAN ID | The Multicast VLAN ID. |
| • IGMP/MLD Queries Received | The number of Received Queries for IGMP and MLD, respectively. |
| • IGMP/MLD Queries Transmitted | The number of Transmitted Queries for IGMP and MLD, respectively. |
| • IGMPv1 Joins Received | The number of Received IGMPv1 Joins. |
| • IGMPv2/MLDv1 Reports Received | The number of Received IGMPv2 Joins and MLDv1 Reports, respectively. |
| • IGMPv3/MLDv2 Reports Received | The number of Received IGMPv1 Joins and MLDv2 Reports, respectively. |
| • IGMPv2/MLDv1 Leaves Received | The number of Received IGMPv2 Leaves and MLDv1 Dones, respectively. |

Buttons

- Refresh** : Click to refresh the page immediately.
- Clear** : Clears all Statistics counters.

Auto-refresh : Automatic refresh occurs every 3 seconds.

4.3.7.3 MVR Groups Information

Entries in the MVR Group Table are shown on this page. The MVR Group Table is sorted first by VLAN ID, and then by group. Each page shows up to 99 entries from the MVR Group table, default being 20, selected through the "entries per page" input field. When first visited, the web page will show the first 20 entries from the beginning of the MVR Group Table.

The "Start from VLAN", and "group" input fields allow the user to select the starting point in the MVR Group Table. The MVR Groups Information screen in [Figure 4-3-7-3](#) appears.

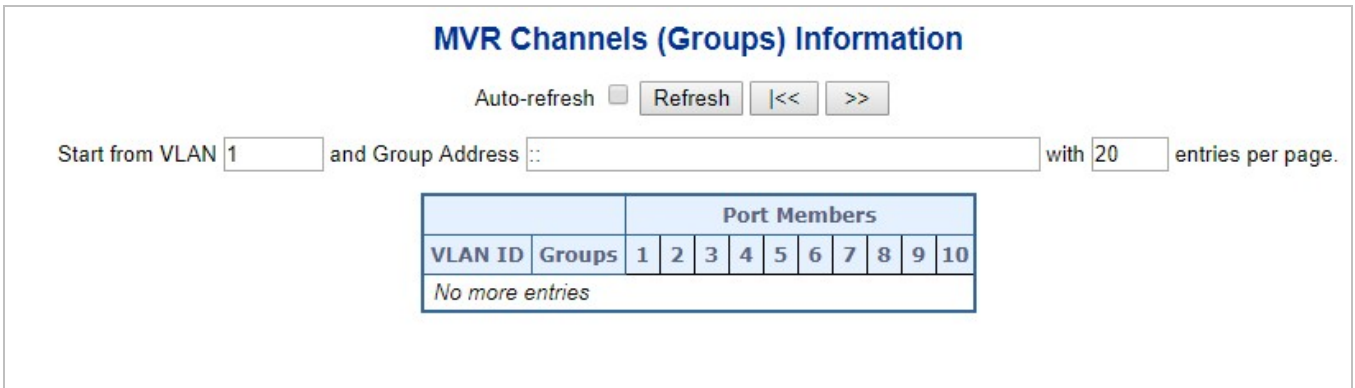

Figure 4-3-7-3: MVR Groups Information Page Screenshot

The page includes the following fields:

| Object | Description |
|----------------|----------------------------------|
| • VLAN | VLAN ID of the group. |
| • Groups | Group ID of the group displayed. |
| • Port Members | Ports under this group. |

Buttons

Auto-refresh : Automatic refresh occurs every 3 seconds.

: Refreshes the displayed table starting from the input fields.

: Updates the table starting from the first entry in the MVR Channels (Groups) Information Table.

: Updates the table, starting with the entry after the last entry currently displayed.

4.3.7.4 MVR SFM Information

Entries in the MVR SFM Information Table are shown on this page. The MVR **SFM (Source-Filtered Multicast)** Information Table also contains the SSM (Source-Specific Multicast) information. This table is sorted first by VLAN ID, then by group, and then by Port. Different source addresses belong to the same group are treated as single entry.

Each page shows up to 99 entries from the MVR SFM Information Table, default being 20, selected through the "entries per page" input field. When first visited, the web page will show the first 20 entries from the beginning of the MVR SFM Information Table.

The "Start from VLAN", and "Group Address" input fields allow the user to select the starting point in the MVR SFM Information Table. The MVR SFM Information screen in [Figure 4-3-7-4](#) appears.



Figure 4-3-7-4: MVR SFM Information Page Screenshot

The page includes the following fields:

| Object | Description |
|-----------------------------------|--|
| • VLAN ID | VLAN ID of the group. |
| • Group | Group address of the group displayed. |
| • Port | Switch port number. |
| • Mode | Indicates the filtering mode maintained per (VLAN ID, port number, Group Address) basis. It can be either Include or Exclude. |
| • Source Address | IP Address of the source. Currently, system limits the total number of IP source addresses for filtering to be 128. When there is no any source filtering address, the text "None" is shown in the Source Address field. |
| • Type | Indicates the Type. It can be either Allow or Deny. |
| • Hardware Filter / Switch | Indicates whether data plane destined to the specific group address from the source IPv4/IPv6 address could be handled by chip or not. |

Buttons

Auto-refresh : Automatic refresh occurs every 3 seconds.

: Refreshes the displayed table starting from the input fields.

: Updates the table starting from the first entry in the MVR SFM Information Table.

4.3.8 LLDP

4.3.8.1 Link Layer Discovery Protocol

Link Layer Discovery Protocol (LLDP) is used to discover basic information about neighboring devices on the local broadcast domain. LLDP is a Layer 2 protocol that uses periodic broadcasts to advertise information about the sending device. Advertised information is represented in **Type Length Value (TLV)** format according to the IEEE 802.1ab standard, and can include details such as device identification, capabilities and configuration settings. LLDP also defines how to store and maintain information gathered about the neighboring network nodes it discovers.

Link Layer Discovery Protocol - Media Endpoint Discovery (LLDP-MED) is an extension of LLDP intended for managing endpoint devices such as Voice over IP phones and network switches. The LLDP-MED TLVs advertise information such as network policy, power, inventory, and device location details. LLDP and LLDP-MED information can be used by SNMP applications to simplify troubleshooting, enhance network management, and maintain an accurate network topology.

4.3.8.2 LLDP Configuration

This page allows the user to inspect and configure the current LLDP port settings. The LLDP Configuration screen in [Figure 4-3-8-1](#) appears.

LLDP Configuration

LLDP Parameters

| | | |
|-------------|----|---------|
| Tx Interval | 30 | seconds |
| Tx Hold | 4 | times |
| Tx Delay | 2 | seconds |
| Tx Reinit | 2 | seconds |

LLDP Port Configuration

| Port | Mode | CDP Aware | Trap | Optional TLVs | | | |
|------|------------|--------------------------|--------------------------|-------------------------------------|-------------------------------------|-------------------------------------|-------------------------------------|
| | | | | Remote Port ID | System Name | System Capabilities | Management Address |
| * | <All> ▼ | <input type="checkbox"/> | <input type="checkbox"/> | <input type="checkbox"/> | <input type="checkbox"/> | <input type="checkbox"/> | <input type="checkbox"/> |
| 1 | Disabled ▼ | <input type="checkbox"/> | <input type="checkbox"/> | <input checked="" type="checkbox"/> | <input checked="" type="checkbox"/> | <input checked="" type="checkbox"/> | <input checked="" type="checkbox"/> |
| 2 | Disabled ▼ | <input type="checkbox"/> | <input type="checkbox"/> | <input checked="" type="checkbox"/> | <input checked="" type="checkbox"/> | <input checked="" type="checkbox"/> | <input checked="" type="checkbox"/> |
| 3 | Disabled ▼ | <input type="checkbox"/> | <input type="checkbox"/> | <input checked="" type="checkbox"/> | <input checked="" type="checkbox"/> | <input checked="" type="checkbox"/> | <input checked="" type="checkbox"/> |
| 4 | Disabled ▼ | <input type="checkbox"/> | <input type="checkbox"/> | <input checked="" type="checkbox"/> | <input checked="" type="checkbox"/> | <input checked="" type="checkbox"/> | <input checked="" type="checkbox"/> |
| 5 | Disabled ▼ | <input type="checkbox"/> | <input type="checkbox"/> | <input checked="" type="checkbox"/> | <input checked="" type="checkbox"/> | <input checked="" type="checkbox"/> | <input checked="" type="checkbox"/> |
| 6 | Disabled ▼ | <input type="checkbox"/> | <input type="checkbox"/> | <input checked="" type="checkbox"/> | <input checked="" type="checkbox"/> | <input checked="" type="checkbox"/> | <input checked="" type="checkbox"/> |
| 7 | Disabled ▼ | <input type="checkbox"/> | <input type="checkbox"/> | <input checked="" type="checkbox"/> | <input checked="" type="checkbox"/> | <input checked="" type="checkbox"/> | <input checked="" type="checkbox"/> |

Figure 4-3-8-1: LLDP Configuration Page Screenshot

The page includes the following fields:

LLDP Parameters

| Object | Description |
|--|---|
| <ul style="list-style-type: none"> Tx Interval | <p>The switch is periodically transmitting LLDP frames to its neighbors for having the network discovery information up-to-date. The interval between each LLDP frame is determined by the Tx Interval value. Valid values are restricted to 5 - 32768 seconds.</p> <p>Default: 30 seconds</p> <p>This attribute must comply with the following rule: (Transmission Interval * Hold Time Multiplier) ≤ 65536, and Transmission Interval ≥ (4 * Delay Interval)</p> |
| <ul style="list-style-type: none"> Tx Hold | <p>Each LLDP frame contains information about how long the information in the LLDP frame shall be considered valid. The LLDP information valid period is set to Tx Hold multiplied by Tx Interval seconds. Valid values are restricted to 2 - 10 times.</p> <p>TTL in seconds is based on the following rule: (Transmission Interval * Holdtime Multiplier) ≤ 65536. Therefore, the default TTL is 4*30 = 120 seconds.</p> |
| <ul style="list-style-type: none"> Tx Delay | <p>If some configuration is changed (e.g. the IP address) a new LLDP frame is transmitted, but the time between the LLDP frames will always be at least the value of Tx Delay seconds. Tx Delay cannot be larger than 1/4 of the Tx Interval value. Valid values are restricted to 1 - 8192 seconds.</p> <p>This attribute must comply with the rule: (4 * Delay Interval) ≤ Transmission Interval</p> |
| <ul style="list-style-type: none"> Tx Reinit | <p>When a port is disabled, LLDP is disabled or the switch is rebooted a LLDP shutdown frame is transmitted to the neighboring units, signaling that the LLDP information isn't valid anymore. Tx Reinit controls the amount of seconds between the shutdown frame and a new LLDP initialization. Valid values are restricted to 1 - 10 seconds.</p> |

LLDP Port Configuration

The LLDP port settings relate to the switch, as reflected by the page header.

| Object | Description |
|---|---|
| <ul style="list-style-type: none"> Port | The switch port number of the logical LLDP port. |
| <ul style="list-style-type: none"> Mode | <p>Select LLDP mode.</p> <ul style="list-style-type: none"> <input checked="" type="checkbox"/> Rx only The switch will not send out LLDP information, but LLDP |

| | |
|--|--|
| | <p>information from neighbor units is analyzed.</p> <ul style="list-style-type: none"> ■ Tx only The switch will drop LLDP information received from neighbors, but will send out LLDP information. ■ Disabled The switch will not send out LLDP information, and will drop LLDP information received from neighbors. ■ Enabled The switch will send out LLDP information, and will analyze LLDP information received from neighbors. |
| <ul style="list-style-type: none"> • CDP Aware | <p>Select CDP awareness.</p> <p>The CDP operation is restricted to decoding incoming CDP frames (The switch doesn't transmit CDP frames). CDP frames are only decoded if LLDP on the port is enabled.</p> <p>Only CDP TLVs that can be mapped to a corresponding field in the LLDP neighbours' table are decoded. All other TLVs are discarded (Unrecognized CDP TLVs and discarded CDP frames are not shown in the LLDP statistics.). CDP TLVs are mapped onto LLDP neighbours' table as shown below.</p> <p>CDP TLV "Device ID" is mapped to the LLDP "Chassis ID" field.</p> <p>CDP TLV "Address" is mapped to the LLDP "Management Address" field. The CDP address TLV can contain multiple addresses, but only the first address is shown in the LLDP neighbours table.</p> <p>CDP TLV "Port ID" is mapped to the LLDP "Port ID" field.</p> <p>CDP TLV "Version and Platform" is mapped to the LLDP "System Description" field.</p> <p>Both the CDP and LLDP support "system capabilities", but the CDP capabilities cover capabilities that are not part of the LLDP. These capabilities are shown as "others" in the LLDP neighbours' table.</p> <p>If all ports have CDP awareness disabled the switch forwards CDP frames received from neighbour devices. If at least one port has CDP awareness enabled all CDP frames are terminated by the switch.</p> <p>Note: When CDP awareness on a port is disabled the CDP information isn't removed immediately, but gets removed when the hold time is exceeded.</p> |
| <ul style="list-style-type: none"> • Port Description | <p>Optional TLV: When checked the "port description" is included in LLDP information transmitted.</p> |
| <ul style="list-style-type: none"> • System Name | <p>Optional TLV: When checked the "system name" is included in LLDP information transmitted.</p> |
| <ul style="list-style-type: none"> • System Description | <p>Optional TLV: When checked the "system description" is included in LLDP information transmitted.</p> |
| <ul style="list-style-type: none"> • System Capabilities | <p>Optional TLV: When checked the "system capability" is included in LLDP information transmitted.</p> |
| <ul style="list-style-type: none"> • Management Address | <p>Optional TLV: When checked the "management address" is included in LLDP</p> |

| | |
|--|--------------------------|
| | information transmitted. |
|--|--------------------------|

Buttons

Apply : Click to apply changes

Reset : Click to undo any changes made locally and revert to previously saved values.

4.3.8.3 LLDP Neighbor

This page provides a status overview for all LLDP neighbors. The displayed table contains a row for each port on which an LLDP neighbor is detected. The LLDP Neighbor Information screen in [Figure 4-3-8-2](#) appears.

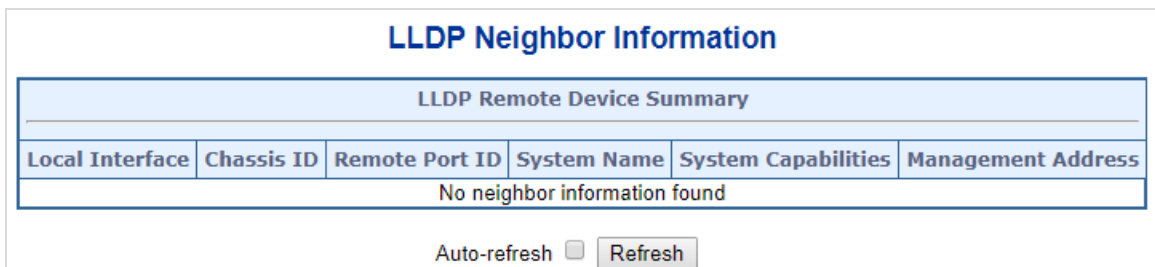

Figure 4-3-8-2: LLDP Neighbor Information Page Screenshot

The page includes the following fields:

| Object | Description |
|------------------------------|---|
| • Local Port | The port on which the LLDP frame was received. |
| • Chassis ID | The Chassis ID is the identification of the neighbor's LLDP frames. |
| • Remote Port ID | The Remote Port ID is the identification of the neighbor port. |
| • Port Description | Port Description is the port description advertised by the neighbor unit. |
| • System Name | System Name is the name advertised by the neighbor unit. |
| • System Capabilities | System Capabilities describes the neighbor unit's capabilities. The possible capabilities are: <ol style="list-style-type: none"> 1. Other 2. Repeater 3. Bridge 4. WLAN Access Point 5. Router 6. Telephone 7. DOCSIS cable device 8. Station only |

| | |
|---|--|
| | <p>9. Reserved</p> <p>When a capability is enabled, the capability is followed by (+). If the capability is disabled, the capability is followed by (-).</p> |
| <ul style="list-style-type: none"> • Management Address | <p>Management Address is the neighbor unit's address that is used for higher layer entities to assist the discovery by the network management. This could for instance hold the neighbor's IP address.</p> |

: Click to refresh the page immediately.

Auto-refresh Check this box to refresh the page automatically. Automatic refresh occurs every 3 seconds.

4.3.8.4 LLDP MED Configuration

This page allows you to configure the LLDP-MED. The LLDPMED Configuration screen in [Figure 4-3-8-3](#) appears.

LLDP-MED Interface Configuration

| Transmit TLVs | | | | |
|---------------|-------------------------------------|-------------------------------------|-------------------------------------|----------------|
| Port | Capabilities | Policies | Location | Device Type |
| * | <input type="checkbox"/> | <input type="checkbox"/> | <input type="checkbox"/> | <All> ▼ |
| 1 | <input checked="" type="checkbox"/> | <input checked="" type="checkbox"/> | <input checked="" type="checkbox"/> | Connectivity ▼ |
| 2 | <input checked="" type="checkbox"/> | <input checked="" type="checkbox"/> | <input checked="" type="checkbox"/> | Connectivity ▼ |
| 3 | <input checked="" type="checkbox"/> | <input checked="" type="checkbox"/> | <input checked="" type="checkbox"/> | Connectivity ▼ |
| 4 | <input checked="" type="checkbox"/> | <input checked="" type="checkbox"/> | <input checked="" type="checkbox"/> | Connectivity ▼ |
| 5 | <input checked="" type="checkbox"/> | <input checked="" type="checkbox"/> | <input checked="" type="checkbox"/> | Connectivity ▼ |
| 6 | <input checked="" type="checkbox"/> | <input checked="" type="checkbox"/> | <input checked="" type="checkbox"/> | Connectivity ▼ |
| 7 | <input checked="" type="checkbox"/> | <input checked="" type="checkbox"/> | <input checked="" type="checkbox"/> | Connectivity ▼ |
| 8 | <input checked="" type="checkbox"/> | <input checked="" type="checkbox"/> | <input checked="" type="checkbox"/> | Connectivity ▼ |
| 9 | <input checked="" type="checkbox"/> | <input checked="" type="checkbox"/> | <input checked="" type="checkbox"/> | Connectivity ▼ |
| 10 | <input checked="" type="checkbox"/> | <input checked="" type="checkbox"/> | <input checked="" type="checkbox"/> | Connectivity ▼ |

Coordinates Location

| | | | | | | | | | | | | |
|----------|---|---|---------|-----------|---|---|--------|----------|---|----------|-----------|---------|
| Latitude | 0 | ° | North ▼ | Longitude | 0 | ° | East ▼ | Altitude | 0 | Meters ▼ | Map Datum | WGS84 ▼ |
|----------|---|---|---------|-----------|---|---|--------|----------|---|----------|-----------|---------|

Civic Address Location

| | | | | | |
|-----------------------|--|--------------------------|--|------------------------|--|
| Country code | | State | | County | |
| City | | City district | | Block (Neighborhood) | |
| Street | | Leading street direction | | Trailing street suffix | |
| Street suffix | | House no. | | House no. suffix | |
| Landmark | | Additional location info | | Name | |
| Zip code | | Building | | Apartment | |
| Floor | | Room no. | | Place type | |
| Postal community name | | P.O. Box | | Additional code | |

Emergency Call Service

Policies

| Delete | Policy ID | Application Type | Tag | VLAN ID | L2 Priority | DSCP |
|--------------------|-----------|------------------|-----|---------|-------------|------|
| No entries present | | | | | | |

Figure 4-3-8-3: LLDPMED Configuration Page Screenshot

The page includes the following fields:

Fast start repeat count

| Object | Description |
|--|--|
| <ul style="list-style-type: none"> • Fast start repeat count | <p>Rapid startup and Emergency Call Service Location Identification Discovery of endpoints is a critically important aspect of VoIP systems in general. In addition, it is best to advertise only those pieces of information which are specifically relevant to particular endpoint types (for example only advertise the voice network policy to permitted voice-capable devices), both in order to conserve the limited LLDPDU space and to reduce security and system integrity issues that can come with inappropriate knowledge of the network policy.</p> <p>With this in mind LLDP-MED defines an LLDP-MED Fast Start interaction between the protocol and the application layers on top of the protocol, in order to achieve these related properties. Initially, a Network Connectivity Device will only transmit LLDP TLVs in an LLDPDU. Only after an LLDP-MED Endpoint Device is detected, will an LLDP-MED capable Network Connectivity Device start to advertise LLDP-MED TLVs in outgoing LLDPDUs on the associated port. The LLDP-MED application will temporarily speed up the transmission of the LLDPDU to start within a second, when a new LLDP-MED neighbour has been detected in order share LLDP-MED information as fast as possible to new neighbours.</p> <p>Because there is a risk of an LLDP frame being lost during transmission between neighbours, it is recommended to repeat the fast start transmission multiple times to increase the possibility of the neighbours receiving the LLDP frame. With Fast start repeat count it is possible to specify the number of times the fast start transmission would be repeated. The recommended value is 4 times, given that 4 LLDP frames with a 1 second interval will be transmitted, when an LLDP frame with new information is received.</p> <p>It should be noted that LLDP-MED and the LLDP-MED Fast Start mechanism is only intended to run on links between LLDP-MED Network Connectivity Devices and Endpoint Devices, and as such does not apply to links between LAN infrastructure elements, including Network Connectivity Devices, or other types of links.</p> |

LLDP-MED Interface Configuration

| Object | Description |
|---|--|
| <ul style="list-style-type: none"> • Interface | <p>The interface name to which the configuration applies.</p> |
| <ul style="list-style-type: none"> • Transmit TLVs - Capabilities | <p>When checked the switch's capabilities is included in LLDP-MED information transmitted</p> |
| <ul style="list-style-type: none"> • Transmit TLVs - Policies | <p>When checked the configured policies for the interface is included in LLDP-MED information transmitted.</p> |

| | |
|---|---|
| <ul style="list-style-type: none"> • Transmit TLVs - Location | <p>When checked the configured location information for the switch is included in LLDP-MED information transmitted.</p> |
| <ul style="list-style-type: none"> • Transmit TLVs - PoE | <p>When checked the configured PoE (Power Over Ethernet) information for the interface is included in LLDP-MED information transmitted</p> |
| <ul style="list-style-type: none"> • Device Type | <p>Any LLDP-MED Device is operating as a specific type of LLDP-MED Device, which may be either a Network Connectivity Device or a specific Class of Endpoint Device, as defined below.</p> <p>A Network Connectivity Device is a LLDP-MED Device that provides access to the IEEE 802 based LAN infrastructure for LLDP-MED Endpoint Devices</p> <p>An LLDP-MED Network Connectivity Device is a LAN access device based on any of the following technologies :</p> <ol style="list-style-type: none"> 1. LAN Switch/Router 2. IEEE 802.1 Bridge 3. IEEE 802.3 Repeater (included for historical reasons) 4. IEEE 802.11 Wireless Access Point 5. Any device that supports the IEEE 802.1AB and MED extensions that can relay IEEE 802 frames via any method. <p>An Endpoint Device a LLDP-MED Device that sits at the network edge and provides some aspect of IP communications service, based on IEEE 802 LAN technology.</p> <p>The main difference between a Network Connectivity Device and an Endpoint Device is that only an Endpoint Device can start the LLDP-MED information exchange.</p> <p>Even though a switch always should be a Network Connectivity Device, it is possible to configure it to act as an Endpoint Device, and thereby start the LLDP-MED information exchange (In the case where two Network Connectivity Devices are connected together)</p> |

Coordinates Location

| Object | Description |
|--|---|
| <ul style="list-style-type: none"> • Latitude | <p>Latitude SHOULD be normalized to within 0-90 degrees with a maximum of 4 digits.</p> <p>It is possible to specify the direction to either North of the equator or South of the equator.</p> |
| <ul style="list-style-type: none"> • Longitude | <p>Longitude SHOULD be normalized to within 0-180 degrees with a maximum of 4 digits.</p> <p>It is possible to specify the direction to either East of the prime meridian or West</p> |

| | |
|--|---|
| | of the prime meridian. |
| <ul style="list-style-type: none"> • Altitude | <p>Altitude SHOULD be normalized to within -32767 to 32767 with a maximum of 4 digits.</p> <p>It is possible to select between two altitude types (floors or meters).</p> <p>Meters: Representing meters of Altitude defined by the vertical datum specified.</p> <p>Floors: Representing altitude in a form more relevant in buildings which have different floor-to-floor dimensions. An altitude = 0.0 is meaningful even outside a building, and represents ground level at the given latitude and longitude. Inside a building, 0.0 represents the floor level associated with ground level at the main entrance.</p> |
| <ul style="list-style-type: none"> • Map Datum | <p>The Map Datum used for the coordinates given in this Option</p> <ul style="list-style-type: none"> ■ WGS84: (Geographical 3D) - World Geodesic System 1984, CRS Code 4327, Prime Meridian Name: Greenwich. ■ NAD83/NAVD88: North American Datum 1983, CRS Code 4269, Prime Meridian Name: Greenwich; The associated vertical datum is the North American Vertical Datum of 1988 (NAVD88). This datum pair is to be used when referencing locations on land, not near tidal water (which would use Datum = NAD83/MLLW). ■ NAD83/MLLW: North American Datum 1983, CRS Code 4269, Prime Meridian Name: Greenwich; The associated vertical datum is Mean Lower Low Water (MLLW). This datum pair is to be used when referencing locations on water/sea/ocean. |

Civic Address Location

IETF Geopriv Civic Address based Location Configuration Information (Civic Address LCI).

| Object | Description |
|---|--|
| <ul style="list-style-type: none"> • Country code | The two-letter ISO 3166 country code in capital ASCII letters - Example: DK, DE or US. |
| <ul style="list-style-type: none"> • State | National subdivisions (state, canton, region, province, prefecture). |
| <ul style="list-style-type: none"> • County | County, parish, gun (Japan), district. |
| <ul style="list-style-type: none"> • City | City, township, shi (Japan) - Example: Copenhagen |
| <ul style="list-style-type: none"> • City district | City division, borough, city district, ward, chou (Japan) |
| <ul style="list-style-type: none"> • Block (Neighborhood) | Neighborhood, block |
| <ul style="list-style-type: none"> • Street | Street - Example: Poppelvej |
| <ul style="list-style-type: none"> • Leading street direction | Leading street direction - Example: N |
| <ul style="list-style-type: none"> • Trailing street suffix | Trailing street suffix - Example: SW |
| <ul style="list-style-type: none"> • Street suffix | Street suffix - Example: Ave, Platz |

| | |
|-----------------------------------|---|
| • House no. | House number - Example: 21 |
| • House no. suffix | House number suffix - Example: A, 1/2 |
| • Landmark | Landmark or vanity address - Example: Columbia University |
| • Additional location info | Additional location info - Example: South Wing |
| • Name | Name (residence and office occupant) - Example: Flemming Jahn |
| • Zip code | Postal/zip code - Example: 2791 |
| • Building | Building (structure) - Example: Low Library |
| • Apartment | Unit (Apartment, suite) - Example: Apt 42 |
| • Floor | Floor - Example: 4 |
| • Room no. | Room number - Example: 450F |
| • Place type | Place type - Example: Office |
| • Postal community name | Postal community name - Example: Leonia |
| • P.O. Box | Post office box (P.O. BOX) - Example: 12345 |
| • Additional code | Additional code - Example: 1320300003 |

Emergency Call Service

Emergency Call Service (e.g. E911 and others), such as defined by TIA or NENA.

| Object | Description |
|---------------------------------|---|
| • Emergency Call Service | Emergency Call Service ELIN identifier data format is defined to carry the ELIN identifier as used during emergency call setup to a traditional CAMA or ISDN trunk-based PSAP. This format consists of a numerical digit string, corresponding to the ELIN to be used for emergency calling. |

Policies

Network Policy Discovery enables the efficient discovery and diagnosis of mismatch issues with the VLAN configuration, along with the associated Layer 2 and Layer 3 attributes, which apply for a set of specific protocol applications on that port. Improper network policy configurations are a very significant issue in VoIP environments that frequently result in voice quality degradation or loss of service.

Policies are only intended for use with applications that have specific 'real-time' network policy requirements, such as interactive voice and/or video services.

The network policy attributes advertised are:

1. Layer 2 VLAN ID (IEEE 802.1Q-2003)
2. Layer 2 priority value (IEEE 802.1D-2004)
3. Layer 3 Diffserv code point (DSCP) value (IETF RFC 2474)

This network policy is potentially advertised and associated with multiple sets of application types supported on a given port. The application types specifically addressed are:

1. Voice
2. Guest Voice
3. Softphone Voice
4. Video Conferencing
5. Streaming Video
6. Control / Signaling (conditionally support a separate network policy for the media types above)

A large network may support multiple VoIP policies across the entire organization, and different policies per application type. LLDP-MED allows multiple policies to be advertised per port, each corresponding to a different application type. Different ports on the same Network Connectivity Device may advertise different sets of policies, based on the authenticated user identity or port configuration.

It should be noted that LLDP-MED is not intended to run on links other than between Network Connectivity Devices and Endpoints, and therefore does not need to advertise the multitude of network policies that frequently run on an aggregated link interior to the LAN.

| Object | Description |
|---|---|
| <ul style="list-style-type: none"> • Delete | Check to delete the policy. It will be deleted during the next save. |
| <ul style="list-style-type: none"> • Policy ID | ID for the policy. This is auto generated and shall be used when selecting the policies that shall be mapped to the specific ports. |
| <ul style="list-style-type: none"> • Application Type | Intended use of the application types: <ul style="list-style-type: none"> ■ Voice - for use by dedicated IP Telephony handsets and other similar appliances supporting interactive voice services. These devices are typically deployed on a separate VLAN for ease of deployment and enhanced security by isolation from data applications. ■ Voice Signaling (conditional) - for use in network topologies that require a different policy for the voice signaling than for the voice media. This application type should not be advertised if all the same network policies apply as those advertised in the Voice application policy. ■ Guest Voice - support a separate 'limited feature-set' voice service for guest users and visitors with their own IP Telephony handsets and other similar appliances supporting interactive voice services. ■ Guest Voice Signaling (conditional) - for use in network topologies that require a different policy for the guest voice signaling than for the guest voice media. This application type should not be advertised if all the same network policies apply as those advertised in the Guest |

| | |
|--|--|
| | <p>Voice application policy.</p> <ul style="list-style-type: none"> ■ Softphone Voice - for use by softphone applications on typical data centric devices, such as PCs or laptops. This class of endpoints frequently does not support multiple VLANs, if at all, and are typically configured to use an 'untagged' VLAN or a single 'tagged' data specific VLAN. When a network policy is defined for use with an 'untagged' VLAN (see Tagged flag below), then the L2 priority field is ignored and only the DSCP value has relevance. ■ Video Conferencing - for use by dedicated Video Conferencing equipment and other similar appliances supporting real-time interactive video/audio services. ■ Streaming Video - for use by broadcast or multicast based video content distribution and other similar applications supporting streaming video services that require specific network policy treatment. Video applications relying on TCP with buffering would not be an intended use of this application type. ■ Video Signaling (conditional) - for use in network topologies that require a separate policy for the video signaling than for the video media. This application type should not be advertised if all the same network policies apply as those advertised in the Video Conferencing application policy. |
| <ul style="list-style-type: none"> • Tag | <p>Tag indicating whether the specified application type is using a 'tagged' or an 'untagged' VLAN.</p> <ul style="list-style-type: none"> ■ Untagged indicates that the device is using an untagged frame format and as such does not include a tag header as defined by IEEE 802.1Q-2003. In this case, both the VLAN ID and the Layer 2 priority fields are ignored and only the DSCP value has relevance. ■ Tagged indicates that the device is using the IEEE 802.1Q tagged frame format, and that both the VLAN ID and the Layer 2 priority values are being used, as well as the DSCP value. The tagged format includes an additional field, known as the tag header. The tagged frame format also includes priority tagged frames as defined by IEEE 802.1Q-2003. |
| <ul style="list-style-type: none"> • VLAN ID | <p>VLAN identifier (VID) for the port as defined in IEEE 802.1Q-2003</p> |
| <ul style="list-style-type: none"> • L2 Priority | <p>L2 Priority is the Layer 2 priority to be used for the specified application type. L2 Priority may specify one of eight priority levels (0 through 7), as defined by IEEE 802.1D-2004. A value of 0 represents use of the default priority as defined in IEEE 802.1D-2004.</p> |
| <ul style="list-style-type: none"> • DSCP | <p>DSCP value to be used to provide Diffserv node behavior for the specified</p> |

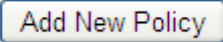
| | |
|--|---|
| | application type as defined in IETF RFC 2474. DSCP may contain one of 64 code point values (0 through 63). A value of 0 represents use of the default DSCP value as defined in RFC 2475. |
| <ul style="list-style-type: none"> • Adding a new policy | Click  to add a new policy. Specify the Application type , Tag , VLAN ID , L2 Priority and DSCP for the new policy. Click "Save". The number of policies supported is 32 |

Port Policies Configuration

Every port may advertise a unique set of network policies or different attributes for the same network policies, based on the authenticated user identity or port configuration.

| Object | Description |
|--|--|
| <ul style="list-style-type: none"> • Port | The port number for which the configuration applies. |
| <ul style="list-style-type: none"> • Policy ID | The set of policies that shall apply for a given port. The set of policies is selected by checkmarking the checkboxes that corresponds to the policies |

Buttons

 : Click to apply changes

 : Click to undo any changes made locally and revert to previously saved values.

4.3.8.5 LLDP-MED Neighbor

This page provides a status overview for all LLDP-MED neighbors. The displayed table contains a row for each port on which an LLDP neighbor is detected. The LLDP-MED Neighbor Information screen in [Figure 4-3-8-4](#) appears. The columns hold the following information:

| LLDP-MED Neighbour Information | | | | | |
|--------------------------------|---|---|---------|---|------|
| Port 1 | | | | | |
| Device Type | Capabilities | | | | |
| Endpoint Class III | LLDP-MED Capabilities, Network Policy, Extended Power via MDI - PD, Inventory | | | | |
| Application Type | Policy | Tag | VLAN ID | Priority | DSCP |
| Voice | Defined | Untagged | - | - | 46 |
| Voice Signaling | Defined | Untagged | - | - | 32 |
| Auto-negotiation | Auto-negotiation status | Auto-negotiation Capabilities | | MAU Type | |
| Supported | Enabled | 1000BASE-T half duplex mode, 1000BASE-X, -LX, -SX, -CX full duplex mode, Asymmetric and Symmetric PAUSE for full-duplex inks, Symmetric PAUSE for full-duplex links | | 100BaseTXFD - 2 pair category 5 UTP, full duplex mode | |

Figure 4-3-8-3: LLDP-MED Neighbor Information Page Screenshot

The page includes the following fields:

Fast start repeat count

| Object | Description |
|---|--|
| <ul style="list-style-type: none"> • Port | <p>The port on which the LLDP frame was received.</p> |
| <ul style="list-style-type: none"> • Device Type | <p>LLDP-MED Devices are comprised of two primary Device Types: Network Connectivity Devices and Endpoint Devices.</p> <p>LLDP-MED Network Connectivity Device Definition</p> <p>LLDP-MED Network Connectivity Devices, as defined in TIA-1057, provide access to the IEEE 802 based LAN infrastructure for LLDP-MED Endpoint Devices. An LLDP-MED Network Connectivity Device is a LAN access device based on any of the following technologies:</p> <ol style="list-style-type: none"> 1. LAN Switch/Router 2. IEEE 802.1 Bridge 3. IEEE 802.3 Repeater (included for historical reasons) 4. IEEE 802.11 Wireless Access Point 5. Any device that supports the IEEE 802.1AB and MED extensions defined by TIA-1057 and can relay IEEE 802 frames via any method. <p>LLDP-MED Endpoint Device Definition</p> <p>Within the LLDP-MED Endpoint Device category, the LLDP-MED scheme is broken into further Endpoint Device Classes, as defined in the following. Each LLDP-MED Endpoint Device Class is defined to build upon the capabilities defined for the previous Endpoint Device Class. Fore-example will any LLDP-MED Endpoint Device claiming compliance as a Media Endpoint (Class II) also support all aspects of TIA-1057 applicable to Generic Endpoints (Class I), and any LLDP-MED Endpoint Device claiming compliance as a Communication Device (Class III) will also support all aspects of TIA-1057 applicable to both Media Endpoints (Class II) and Generic Endpoints (Class I).</p> <p>LLDP-MED Generic Endpoint (Class I)</p> <p>The LLDP-MED Generic Endpoint (Class I) definition is applicable to all endpoint products that require the base LLDP discovery services defined in TIA-1057, however do not support IP media or act as an end-user communication appliance. Such devices may include (but are not limited to) IP Communication Controllers, other communication related servers, or any device requiring basic services as defined in TIA-1057.</p> <p>Discovery services defined in this class include LAN configuration, device location, network policy, power management, and inventory management.</p> <p>LLDP-MED Media Endpoint (Class II)</p> <p>The LLDP-MED Media Endpoint (Class II) definition is applicable to all endpoint products that have IP media capabilities however may or may not be associated with a particular end user. Capabilities include all of the capabilities defined for the previous Generic Endpoint Class (Class I), and are extended to include</p> |

| | |
|--|--|
| | <p>aspects related to media streaming. Example product categories expected to adhere to this class include (but are not limited to) Voice / Media Gateways, Conference Bridges, Media Servers, and similar.</p> <p>Discovery services defined in this class include media-type-specific network layer policy discovery.</p> <p>LLDP-MED Communication Endpoint (Class III)</p> <p>The LLDP-MED Communication Endpoint (Class III) definition is applicable to all endpoint products that act as end user communication appliances supporting IP media. Capabilities include all of the capabilities defined for the previous Generic Endpoint (Class I) and Media Endpoint (Class II) classes, and are extended to include aspects related to end user devices. Example product categories expected to adhere to this class include (but are not limited to) end user communication appliances, such as IP Phones, PC-based softphones, or other communication appliances that directly support the end user.</p> <p>Discovery services defined in this class include provision of location identifier (including ECS / E911 information), embedded L2 switch support, inventory management</p> |
| <ul style="list-style-type: none"> • LLDP-MED Capabilities | <p>LLDP-MED Capabilities describes the neighbor unit's LLDP-MED capabilities.</p> <p>The possible capabilities are:</p> <ol style="list-style-type: none"> 1. LLDP-MED capabilities 2. Network Policy 3. Location Identification 4. Extended Power via MDI - PSE 5. Extended Power via MDI - PD 6. Inventory 7. Reserved |
| <ul style="list-style-type: none"> • Application Type | <p>Application Type indicating the primary function of the application(s) defined for this network policy, advertised by an Endpoint or Network Connectivity Device.</p> <p>The possible application types are shown below.</p> <ul style="list-style-type: none"> ■ Voice - for use by dedicated IP Telephony handsets and other similar appliances supporting interactive voice services. These devices are typically deployed on a separate VLAN for ease of deployment and enhanced security by isolation from data applications. ■ Voice Signaling - for use in network topologies that require a different policy for the voice signaling than for the voice media. ■ Guest Voice - to support a separate limited feature-set voice service for guest users and visitors with their own IP Telephony handsets and other similar appliances supporting interactive voice services. ■ Guest Voice Signaling - for use in network topologies that require a different |

| | |
|----------------------------------|---|
| | <p>policy for the guest voice signaling than for the guest voice media.</p> <ul style="list-style-type: none"> ■ Softphone Voice - for use by softphone applications on typical data centric devices, such as PCs or laptops. ■ Video Conferencing - for use by dedicated Video Conferencing equipment and other similar appliances supporting real-time interactive video/audio services. ■ Streaming Video - for use by broadcast or multicast based video content distribution and other similar applications supporting streaming video services that require specific network policy treatment. Video applications relying on TCP with buffering would not be an intended use of this application type. ■ Video Signaling - for use in network topologies that require a separate policy for the video signaling than for the video media. |
| • Policy | <p>Policy indicates that an Endpoint Device wants to explicitly advertise that the policy is required by the device. Can be either Defined or Unknown</p> <ul style="list-style-type: none"> ■ Unknown: The network policy for the specified application type is currently unknown. ■ Defined: The network policy is defined. |
| • TAG | <p>TAG is indicating whether the specified application type is using a tagged or an untagged VLAN. Can be Tagged or Untagged</p> <ul style="list-style-type: none"> ■ Untagged: The device is using an untagged frame format and as such does not include a tag header as defined by IEEE 802.1Q-2003. ■ Tagged: The device is using the IEEE 802.1Q tagged frame format |
| • VLAN ID | <p>VLAN ID is the VLAN identifier (VID) for the port as defined in IEEE 802.1Q-2003. A value of 1 through 4094 is used to define a valid VLAN ID. A value of 0 (Priority Tagged) is used if the device is using priority tagged frames as defined by IEEE 802.1Q-2003, meaning that only the IEEE 802.1D priority level is significant and the default PVID of the ingress port is used instead.</p> |
| • Priority | <p>Priority is the Layer 2 priority to be used for the specified application type. One of eight priority levels (0 through 7)</p> |
| • DSCP | <p>DSCP is the DSCP value to be used to provide Diffserv node behavior for the specified application type as defined in IETF RFC 2474. Contain one of 64 code point values (0 through 63).</p> |
| • Auto-negotiation | <p>Auto-negotiation identifies if MAC/PHY auto-negotiation is supported by the link partner.</p> |
| • Auto-negotiation status | <p>Auto-negotiation status identifies if auto-negotiation is currently enabled at the link partner. If Auto-negotiation is supported and Auto-negotiation status is disabled, the 802.3 PMD operating mode will be determined the operational MAU type field value rather than by auto-negotiation.</p> |

| | |
|---|---|
| <ul style="list-style-type: none"> • Auto-negotiation Capabilities | Auto-negotiation Capabilities shows the link partners MAC/PHY capabilities. |
|---|---|

Buttons

: Click to refresh the page immediately.

Auto-refresh Check this box to refresh the page automatically. Automatic refresh occurs every 3 seconds.

4.3.8.6 Port Statistics

This page provides an overview of all LLDP traffic. Two types of counters are shown. Global counters are counters that refer to the whole switch, while local counters refers to counters for the currently selected switch. The LLDP Statistics screen in [Figure 4-3-8-5](#) appears.

LLDP Global Counters

| Global Counters | |
|------------------------------------|---|
| Clear global counters | <input checked="" type="checkbox"/> |
| Neighbor entries were last changed | 1970-01-01 Thu 00:00:00+00:00 (75569 secs. ago) |
| Total Neighbors Entries Added | 0 |
| Total Neighbors Entries Deleted | 0 |
| Total Neighbors Entries Dropped | 0 |
| Total Neighbors Entries Aged Out | 0 |

LLDP Statistics Local Counters

| Local Interface | Tx Frames | Rx Frames | Rx Errors | Frames Discarded | TLVs Discarded | TLVs Unrecognized | Org. Discarded | Age-Outs | Clear |
|-----------------|-----------|-----------|-----------|------------------|----------------|-------------------|----------------|----------|-------------------------------------|
| * | * | * | * | * | * | * | * | * | <input type="checkbox"/> |
| 1 | 0 | 0 | 0 | 0 | 0 | 0 | 0 | 0 | <input checked="" type="checkbox"/> |
| 2 | 0 | 0 | 0 | 0 | 0 | 0 | 0 | 0 | <input checked="" type="checkbox"/> |
| 3 | 0 | 0 | 0 | 0 | 0 | 0 | 0 | 0 | <input checked="" type="checkbox"/> |
| 4 | 0 | 0 | 0 | 0 | 0 | 0 | 0 | 0 | <input checked="" type="checkbox"/> |
| 5 | 0 | 0 | 0 | 0 | 0 | 0 | 0 | 0 | <input checked="" type="checkbox"/> |
| 6 | 0 | 0 | 0 | 0 | 0 | 0 | 0 | 0 | <input checked="" type="checkbox"/> |
| 7 | 0 | 0 | 0 | 0 | 0 | 0 | 0 | 0 | <input checked="" type="checkbox"/> |
| 8 | 0 | 0 | 0 | 0 | 0 | 0 | 0 | 0 | <input checked="" type="checkbox"/> |
| 9 | 0 | 0 | 0 | 0 | 0 | 0 | 0 | 0 | <input checked="" type="checkbox"/> |
| 10 | 0 | 0 | 0 | 0 | 0 | 0 | 0 | 0 | <input checked="" type="checkbox"/> |

Auto-refresh

Figure 4-3-8-5: LLDP Statistics Page Screenshot

The page includes the following fields:

Global Counters

| Object | Description |
|---|--|
| • Clear global counters | If checked the global counters are cleared when <input type="button" value="Clear"/> is pressed. |
| • Neighbor entries were last changed | It also shows the time when the last entry was last deleted or added. It also shows the time elapsed since the last change was detected. |
| • Total Neighbors Entries Added | Shows the number of new entries added since switch reboot. |
| • Total Neighbors Entries Deleted | Shows the number of new entries deleted since switch reboot. |
| • Total Neighbors Entries Dropped | Shows the number of LLDP frames dropped due to that the entry table was full. |
| • Total Neighbors Entries Aged Out | Shows the number of entries deleted due to Time-To-Live expiring. |

LLDP Statistics Local Counters

The displayed table contains a row for each port. The columns hold the following information:

| Object | Description |
|----------------------------|---|
| • Local Port | The port on which LLDP frames are received or transmitted. |
| • Tx Frames | The number of LLDP frames transmitted on the port. |
| • Rx Frames | The number of LLDP frames received on the port. |
| • Rx Errors | The number of received LLDP frames containing some kind of error. |
| • Frames Discarded | If an LLDP frame is received on a port, and the switch's internal table has run full, the LLDP frame is counted and discarded. This situation is known as "Too Many Neighbors" in the LLDP standard. LLDP frames require a new entry in the table when the Chassis ID or Remote Port ID is not already contained within the table. Entries are removed from the table when a given port links down, an LLDP shutdown frame is received, or when the entry ages out. |
| • TLVs Discarded | Each LLDP frame can contain multiple pieces of information, known as TLVs (TLV is short for "Type Length Value"). If a TLV is malformed, it is counted and discarded. |
| • TLVs Unrecognized | The number of well-formed TLVs, but with an unknown type value. |
| • Org. Discarded | The number of organizationally TLVs received. |
| • Age-Outs | Each LLDP frame contains information about how long time the LLDP information is valid (age-out time). If no new LLDP frame is received within the |

| | |
|--|---|
| | age out time, the LLDP information is removed, and the Age-Out counter is incremented. |
|--|---|

Buttons

: Click to refresh the page immediately.

: Clears the local counters. All counters (including global counters) are cleared upon reboot.

Auto-refresh Check this box to refresh the page automatically. Automatic refresh occurs every 3 seconds.

4.3.9 MAC Address Table

Switching of frames is based upon the DMAC address contained in the frame. The **Industrial Managed Switch** builds up a table that maps MAC addresses to switch ports for knowing which ports the frames should go to (based upon the DMAC address in the frame). This table contains both static and dynamic entries. The static entries are configured by the network administrator if the administrator wants to do a fixed mapping between the DMAC address and switch ports.

The frames also contain a MAC address (SMAC address), which shows the MAC address of the equipment sending the frame. The SMAC address is used by the switch to automatically update the MAC table with these dynamic MAC addresses. Dynamic entries are removed from the MAC table if no frame with the corresponding SMAC address have been seen after a configurable age time.

4.3.9.1 MAC Table Configuration

The MAC Address Table is configured on this page. Set timeouts for entries in the dynamic MAC Table and configure the static MAC table here. The MAC Address Table Configuration screen in [Figure 4-3-9-1](#) appears.

MAC Address Table Configuration

Aging Configuration

| | |
|-------------------------|--------------------------|
| Disable Automatic Aging | <input type="checkbox"/> |
| Aging Time | 300 seconds |

MAC Table Learning

| | Port Members | | | | | | | | | |
|---------|----------------------------------|----------------------------------|----------------------------------|----------------------------------|----------------------------------|----------------------------------|----------------------------------|----------------------------------|----------------------------------|----------------------------------|
| | 1 | 2 | 3 | 4 | 5 | 6 | 7 | 8 | 9 | 10 |
| Auto | <input checked="" type="radio"/> | <input checked="" type="radio"/> | <input checked="" type="radio"/> | <input checked="" type="radio"/> | <input checked="" type="radio"/> | <input checked="" type="radio"/> | <input checked="" type="radio"/> | <input checked="" type="radio"/> | <input checked="" type="radio"/> | <input checked="" type="radio"/> |
| Disable | <input type="radio"/> | <input type="radio"/> | <input type="radio"/> | <input type="radio"/> | <input type="radio"/> | <input type="radio"/> | <input type="radio"/> | <input type="radio"/> | <input type="radio"/> | <input type="radio"/> |
| Secure | <input type="radio"/> | <input type="radio"/> | <input type="radio"/> | <input type="radio"/> | <input type="radio"/> | <input type="radio"/> | <input type="radio"/> | <input type="radio"/> | <input type="radio"/> | <input type="radio"/> |

VLAN Learning Configuration

| | |
|-------------------------|--|
| Learning-disabled VLANs | |
|-------------------------|--|

Static MAC Table Configuration

| | | | Port Members | | | | | | | | | |
|---|---------|-------------|--------------|---|---|---|---|---|---|---|---|----|
| Delete | VLAN ID | MAC Address | 1 | 2 | 3 | 4 | 5 | 6 | 7 | 8 | 9 | 10 |
| <input type="button" value="Add New Static Entry"/> | | | | | | | | | | | | |
| <input type="button" value="Apply"/> <input type="button" value="Reset"/> | | | | | | | | | | | | |

Figure 4-3-9-1: MAC Address Table Configuration Page Screenshot

The page includes the following fields:

Aging Configuration

By default, dynamic entries are removed from the MAC table after 300 seconds. This removal is also called aging.

| Object | Description |
|--|---|
| <ul style="list-style-type: none"> • Disable Automatic Aging | Enables/disables the automatic aging of dynamic entries |
| <ul style="list-style-type: none"> • Aging Time | The time after which a learned entry is discarded. By default, dynamic entries are removed from the MAC after 300 seconds. This removal is also called aging. (Range: 10-10000000 seconds; Default: 300 seconds) |

MAC Table Learning

If the learning mode for a given port is grayed out, another module is in control of the mode, so that it cannot be changed by the user. An example of such a module is the MAC-Based Authentication under 802.1X.

| Object | Description |
|--|--|
| <ul style="list-style-type: none"> • Auto | Learning is done automatically as soon as a frame with unknown SMAC is received. |
| <ul style="list-style-type: none"> • Disable | No learning is done. |
| <ul style="list-style-type: none"> • Secure | Only static MAC entries are learned, all other frames are dropped. Note: Make sure that the link used for managing the switch is added to the Static Mac Table before changing to secure learning mode, otherwise the management link is lost and can only be restored by using another non-secure port or by connecting to the switch via the serial interface. |

Static MAC Table Configuration

The static entries in the MAC table are shown in this table. The static MAC table can contain 64 entries. The MAC table is sorted first by VLAN ID and then by MAC address.

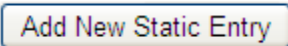
| Object | Description |
|--|---|
| <ul style="list-style-type: none"> • Delete | Check to delete the entry. It will be deleted during the next save. |
| <ul style="list-style-type: none"> • VLAN ID | The VLAN ID of the entry. |
| <ul style="list-style-type: none"> • MAC Address | The MAC address of the entry. |
| <ul style="list-style-type: none"> • Port Members | Checkmarks indicate which ports are members of the entry. Check or uncheck as needed to modify the entry. |
| <ul style="list-style-type: none"> • Adding a New Static Entry | Click  to add a new entry to the static MAC table. Specify the VLAN ID, MAC address, and port members for the new entry. Click "Save". |

Buttons

: Click to apply changes

: Click to undo any changes made locally and revert to previously saved values.

4.3.9.2 MAC Address Table Status

Dynamic MAC Table

Entries in the MAC Table are shown on this page. The MAC Table contains up to **8192** entries, and is sorted first by VLAN ID, then by MAC address. The MAC Address Table screen in [Figure 4-3-9-2](#) appears.

MAC Address Table

Start from VLAN and MAC Address with entries per page.

Query by:

| | |
|--------------------------------------|----------------------|
| <input type="checkbox"/> Interface | CPU ▾ |
| <input type="checkbox"/> VLAN | <input type="text"/> |
| <input type="checkbox"/> MAC Address | <input type="text"/> |

| Type | VLAN | MAC Address | Port Members | | | | | | | | | | | | | |
|---------|------|-------------------|--------------|---|---|---|---|---|---|---|---|---|----|---|---|---|
| | | | CPU | 1 | 2 | 3 | 4 | 5 | 6 | 7 | 8 | 9 | 10 | | | |
| Dynamic | 1 | 00-30-4F-9E-B7-DF | | ✓ | | | | | | | | | | | | |
| Static | 1 | 01-00-5E-00-00-01 | ✓ | ✓ | ✓ | ✓ | ✓ | ✓ | ✓ | ✓ | ✓ | ✓ | ✓ | ✓ | ✓ | ✓ |
| Static | 1 | 33-33-00-00-00-01 | ✓ | ✓ | ✓ | ✓ | ✓ | ✓ | ✓ | ✓ | ✓ | ✓ | ✓ | ✓ | ✓ | ✓ |
| Static | 1 | 33-33-FF-11-22-34 | ✓ | ✓ | ✓ | ✓ | ✓ | ✓ | ✓ | ✓ | ✓ | ✓ | ✓ | ✓ | ✓ | ✓ |
| Static | 1 | FF-FF-FF-FF-FF-FF | ✓ | ✓ | ✓ | ✓ | ✓ | ✓ | ✓ | ✓ | ✓ | ✓ | ✓ | ✓ | ✓ | ✓ |

Auto-refresh

Figure 4-3-9-2: MAC Address Table Status Page Screenshot

Navigating the MAC Table

Each page shows up to 999 entries from the MAC table, default being 20, selected through the "entries per page" input field. When first visited, the web page will show the first 20 entries from the beginning of the MAC Table. The first displayed will be the one with the lowest VLAN ID and the lowest MAC address found in the MAC Table.

The "Start from MAC address" and "VLAN" input fields allow the user to select the starting point in the MAC Table. Clicking the "Refresh" button will update the displayed table starting from that or the closest next MAC Table match.

In addition, the two input fields will - upon a **Refresh** button click - assume the value of the first displayed entry, allowing for continuous refresh with the same start address.

The **>>** will use the last entry of the currently displayed VLAN/MAC address pairs as a basis for the next lookup. When the end is reached the text "no more entries" is shown in the displayed table. Use the **|<<** button to start over.

The page includes the following fields:

| Object | Description |
|-----------------------|---|
| • Type | Indicates whether the entry is a static or dynamic entry. |
| • VLAN | The VLAN ID of the entry. |
| • MAC Address | The MAC address of the entry. |
| • Port Members | The ports that are members of the entry. |

Buttons

Auto-refresh Automatic refresh occurs every 3 seconds.

 : Refreshes the displayed table starting from the "Start from MAC address" and "VLAN" input fields.

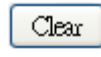
 : Flushes all dynamic entries.

 : Updates the table starting from the first entry in the MAC Table, i.e. the entry with the lowest VLAN ID and MAC address.

 : Updates the table, starting with the entry after the last entry currently displayed.

4.3.10 Loop Protection

This chapter describes enabling loop protection function that provides loop protection to prevent broadcast loops in **Industrial Managed Switch**.

4.3.10.1 Configuration

This page allows the user to inspect the current Loop Protection configurations, and possibly change them as well as screen in [Figure 4-3-10-1](#) appears.

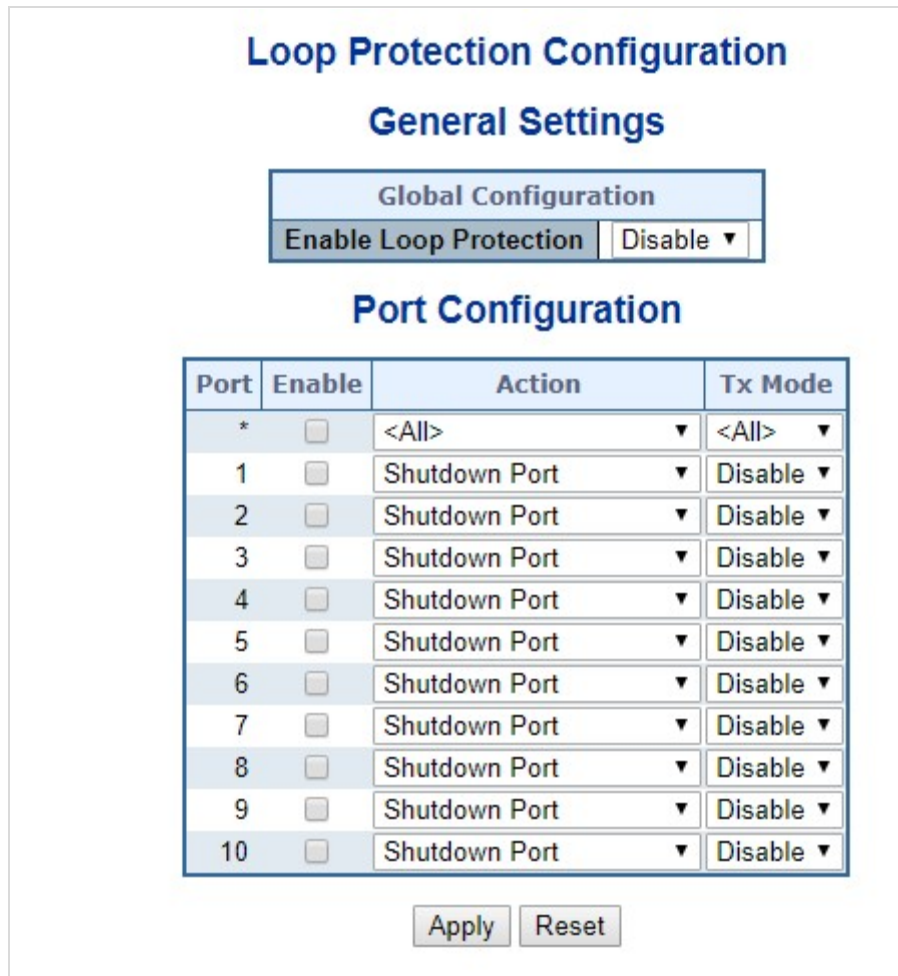

Figure 4-3-10-1: Loop Protection Configuration Page Screenshot

The page includes the following fields:

General Settings

| Object | Description |
|---|---|
| <ul style="list-style-type: none"> • Enable Loop Protection | Controls whether loop protection is enabled (as a whole). |

Port Configuration

| Object | Description |
|------------------|--|
| • Port | The switch port number of the port. |
| • Enable | Controls whether loop protection is enabled on this switch port. |
| • Action | Configures the action performed when a loop is detected on a port. Valid values are Shutdown Port , Shutdown Port and Log or Log Only . |
| • Tx Mode | Controls whether the port is actively generating loop protection PDU's, or whether it is just passively looking for looped PDU's. |

Buttons

: Click to apply changes

: Click to undo any changes made locally and revert to previously saved values.

4.3.10.2 Loop Protection Status

This page displays the loop protection port status of the switch; screen in [Figure 4-3-10-2](#) appears.



Figure 4-3-10-2: Loop Protection Status Screenshot

The page includes the following fields:

| Object | Description |
|----------------------------|---|
| • Port | The Industrial Managed Switch port number of the logical port. |
| • Action | The currently configured port action. |
| • Transmit | The currently configured port transmit mode. |
| • Loops | The number of loops detected on this port. |
| • Status | The current loop protection status of the port. |
| • Loop | Whether a loop is currently detected on the port. |
| • Time of Last Loop | The time of the last loop event detected. |

Buttons

: Click to refresh the page immediately.

Auto-refresh Check this box to enable an automatic refresh of the page at regular intervals.

4.3.11 UDLD

Unidirectional Link Detection (UDLD) is a data link layer protocol from Cisco Systems to monitor the physical configuration of the cables and detect unidirectional links. UDLD complements the Spanning Tree Protocol which is used to eliminate switching loops..

4.3.11.1 UDLD Port Configuration

This page allows the user to inspect the current UDLD configurations, and possibly change them as well. as screen in [Figure 4-3-11-1](#) appears.

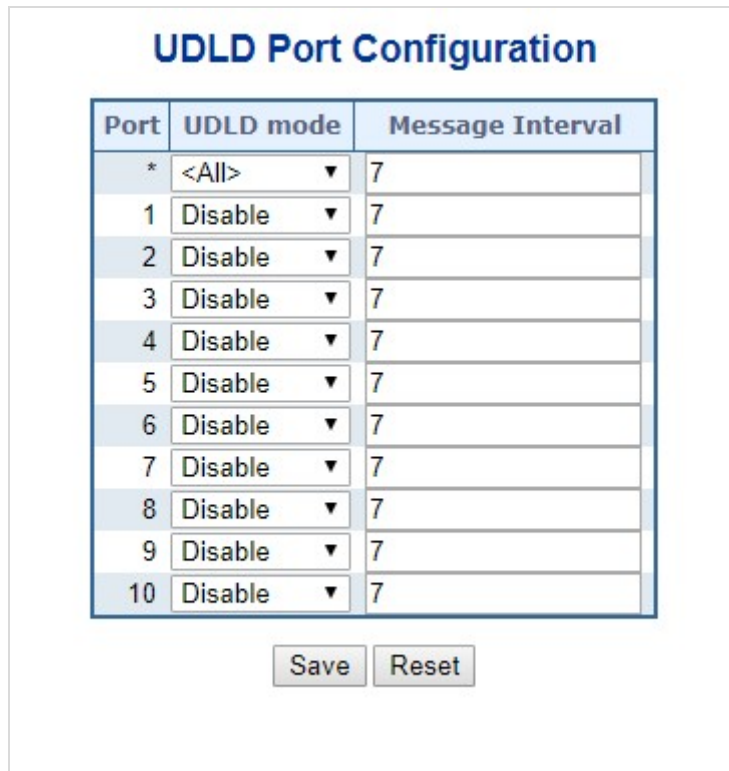

Figure 4-3-11-1: UDLD Configuration Page Screenshot

The page includes the following fields:

General Settings

| Object | Description |
|---|--|
| <ul style="list-style-type: none"> Port | Port number of the switch. |
| <ul style="list-style-type: none"> UDLD Mode | <p>Configures the UDLD mode on a port. Valid values are Disable, Normal and Aggressive. Default mode is Disable.</p> <p>Disable: In disabled mode, UDLD functionality doesn't exists on port..</p> <p>Normal: In normal mode, if the link state of the port was determined to be unidirectional, it will not affect the port state.</p> |

| | |
|---------------------------|--|
| | Aggressive: In aggressive mode, unidirectional detected ports will get shutdown. To bring back the ports up, need to disable UDLD on that port |
| • Message Interval | Configures the period of time between UDLD probe messages on ports that are in the advertisement phase and are determined to be bidirectional. The range is from 7 to 90 seconds(Default value is 7 seconds)(Currently default time interval is supported, due to lack of detailed information in RFC 5171). |

Buttons

: Click to apply changes

: Click to undo any changes made locally and revert to previously saved values.

4.3.11.2 UDLD Status

This page displays the UDLD status of the ports as well. as screen in [Figure 4-3-11-2](#) appears.

Detailed UDLD Status for Port 1

Port 1 ▾
Auto-refresh

| UDLD status | |
|---------------------|-------------------|
| UDLD Admin state | Disable |
| Device ID(local) | 00-30-4F-11-22-34 |
| Device Name(local) | MGS-5220-8P2X |
| Bidirectional State | Indeterminant |

Neighbour Status

| Port | Device Id | Link Status | Device Name |
|---|-----------|-------------|-------------|
| <i>No Neighbour ports enabled or no existing partners</i> | | | |

Figure 4-3-11-2: UDLD status Page Screenshot

The page includes the following fields:

UDLD port status

| Object | Description |
|------------------------------|--|
| • UDLD Admin State | The current port state of the logical port, Enabled if any of state(Normal,Aggressive) is Enabled. |
| • Device ID(local) | The ID of Device |
| • Device Name(local) | Name of the Device. |
| • Bidirectional State | The current state of the port. |

Neighbour Status

| Object | Description |
|----------------------|--|
| • Port | The current port of neighbour device |
| • Device ID | The current ID of neighbour device. |
| • Link Status | The current link status of neighbour port. |
| • Device Name | Name of the Neighbour Device. |

Buttons

: Click to refresh the page immediately..

4.3.12 GVRP

GVRP (GARP VLAN Registration Protocol or Generic VLAN Registration Protocol) is a protocol that facilitates control of virtual local area networks (VLANs) within a larger network

4.3.12.1 GVRP Configuration

This page allows you to configure the global GVRP configuration settings that are commonly applied to all GVRP enabled ports. as well. as screen in [Figure 4-3-12-1](#) appears.



Figure 4-3-12-1: GVRP Configuration Page Screenshot

The page includes the following fields:

General Settings

| Object | Description |
|---|---|
| <ul style="list-style-type: none"> • Enable GVRP globally | The GVRP feature is globally enabled by setting the check mark in the checkbox named Enable GVRP and pressing the Save button. |
| <ul style="list-style-type: none"> • GVRP protocol timers | <p>Join-time is a value in the range of 1-20cs, i.e. in units of one hundredth of a second. The default value is 20cs.</p> <p>Leave-time is a value in the range of 60-300cs, i.e. in units of one hundredth of a second. The default is 60cs.</p> <p>LeaveAll-time is a value in the range of 1000-5000cs, i.e. in units of one hundredth of a second. The default is 1000cs</p> |
| <ul style="list-style-type: none"> • Max number of VLANs | When GVRP is enabled, a maximum number of VLANs supported by GVRP is |

| | |
|--|---|
| | specified. By default this number is 20. This number can only be changed when GVRP is turned off. |
|--|---|

Buttons

: Click to refresh the page. Note that unsaved changes will be lost.

: Click to undo any changes made locally and revert to previously saved values.

4.3.12.2 GVRP Port Configuration

This configuration can be performed either before or after GVRP is configured globally - the protocol operation will be the same. as well. as screen in [Figure 4-3-12-2](#) appears.

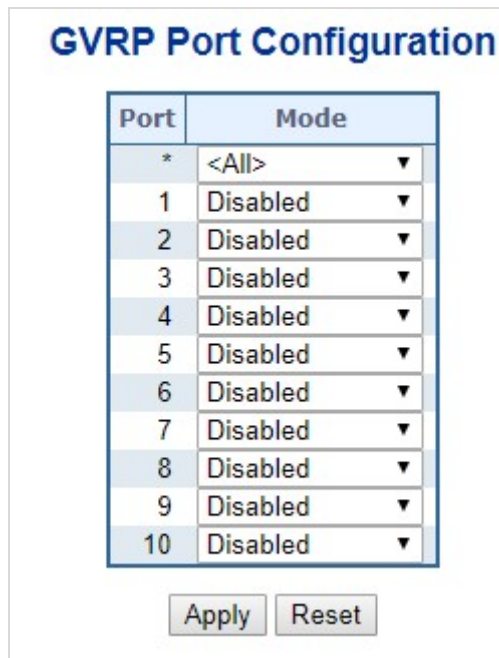



Figure 4-3-11-2: GVRP Port Configuration Page Screenshot

The page includes the following fields:

General Settings

| Object | Description |
|---------------|--|
| • Port | The logical port that is to be configured. |
| • Mode | Mode can be either 'Disabled' or 'GVRP enabled'. These values turn the GVRP feature off or on respectively for the port in question. |

Buttons

: Click to refresh the page. Note that unsaved changes will be lost.

: Click to undo any changes made locally and revert to previously saved values.

4.3.13 PTP

The **Precision Time Protocol (PTP)** is a protocol used to synchronize clocks throughout a computer network. On a local area network, it achieves clock accuracy in the sub-microsecond range, making it suitable for measurement and control systems. PTP was originally defined in the **IEEE 1588-2002** standard, officially entitled "*Standard for a Precision Clock Synchronization Protocol for Networked Measurement and Control Systems*" and published in 2002. In 2008 a revised standard, **IEEE 588-2008** was released. This new version, also known as PTP Version 2, improves accuracy, precision and robustness but is not backwards compatible with the original 2002 version.

"IEEE 1588 is designed to fill a niche not well served by either of the two dominant protocols, **NTP** and **GPS**. IEEE 1588 is designed for local systems requiring accuracies beyond those attainable using NTP. It is also designed for applications that cannot bear the cost of a GPS receiver at each node, or for which GPS signals are inaccessible"

4.3.13.1 PTP Configuration

This page allows the user to configure and inspect the current PTP clock settings. as screen in [Figure 4-3-12-1](#) appears.

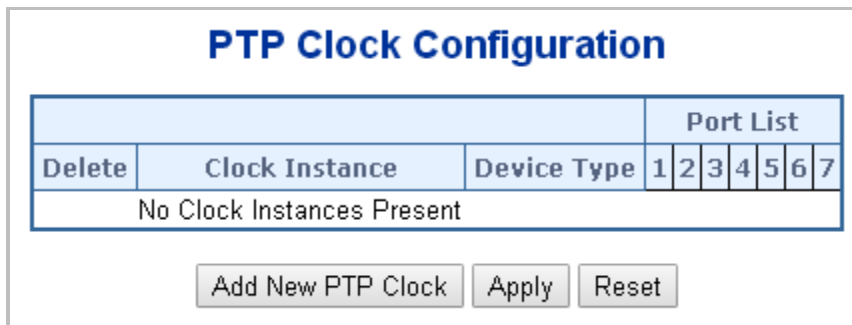

Figure 4-3-13-1: PTP Configuration Page Screenshot

The page includes the following fields:

General Settings

| Object | Description |
|---|---|
| <ul style="list-style-type: none"> • Delete | Check this box and click on 'Save' to delete the clock instance. |
| <ul style="list-style-type: none"> • Clock Instance | Indicates the Instance of a particular Clock Instance [0..3]. Click on the Clock Instance number to edit the Clock details |
| <ul style="list-style-type: none"> • Device Type | Indicates the Type of the Clock Instance. There are five Device Types. <ul style="list-style-type: none"> ■ Ord-Bound - clock's Device Type is Ordinary-Boundary Clock. ■ P2p Transp - clock's Device Type is Peer to Peer Transparent Clock. |

| | |
|--------------------------|---|
| | <ul style="list-style-type: none"> ■ E2e Transp - clock's Device Type is End to End Transparent Clock. ■ Master Only - clock's Device Type is Master Only. ■ Slave Only - clock's Device Type is Slave Only |
| • Port List | Set check mark for each port configured for this Clock Instance. |
| • 2 Step Flag | Static member: defined by the system, true if two-step Sync events and Pdelay_Resp events are used. |
| • Clock Identity | It shows unique clock identifier. |
| • One Way | If true, one-way measurements are used. This parameter applies only to a slave. In one-way mode no delay measurements are performed, i.e. this is applicable only if frequency synchronization is needed. The master always responds to delay requests. |
| • Protocol | <p>Transport protocol used by the PTP protocol engine</p> <p>ethernet PTP over Ethernet multicast</p> <p>ip4multi PTP over IPv4 multicast</p> <p>ip4uni PTP over IPv4 unicast</p> <p>Note : IPv4 unicast protocol only works in Master only and Slave only clocks</p> <p>See parameter Device Type</p> <p>In a unicast Slave only clock you also need configure which master clocks to request Announce and Sync messages from. See: Unicast Slave configuration</p> |
| • VLAN Tag Enable | <p>Enables the VLAN tagging for the PTP frames.</p> <p>Note: Packets are only tagged if the port is configured for VLAN tagging.</p> <p>i.e:</p> <p>Port Type! = Unaware and Port VLAN mode == None, and the port is member of the VLAN.</p> |
| • VID | VLAN Identifier used for tagging the PTP frames. |
| • PCP | Priority Code Point value used for PTP frames. |

Buttons

: Click to create a new clock instance.

: Click to apply changes

: Click to undo any changes made locally and revert to previously saved values.

Local Clock Current Time

| Object | Description |
|--------------------------------------|---|
| • PTP Time | Shows the actual PTP time with nanosecond resolution. |
| • Clock Adjustment Method | Shows the actual clock adjustment method. The method depends on the available hardware. |
| • Synchronize to System Clock | Activate this button to synchronize the System Clock to PTP Time. |
| • Ports Configuration | Click to edit the port data set for the ports assigned to this clock instance. |

Clock Default Data Set

| Object | Description |
|-------------------------|---|
| • Clock ID | An internal instance id (0..3) |
| • Device Type | Indicates the Type of the Clock Instance. There are five Device Types. <ul style="list-style-type: none"> ■ Ord-Bound - clock's Device Type is Ordinary-Boundary Clock. ■ P2p Transp - clock's Device Type is Peer to Peer Transparent Clock. ■ E2e Transp - clock's Device Type is End to End Transparent Clock. ■ Master Only - clock's Device Type is Master Only. Slave Only - clock's Device Type is Slave Only |
| • 2 Step Flag | Static member: defined by the system, true if two-step Sync events and Pdelay_Resp events are used |
| • Ports | The total number of physical ports in the node |
| • Clock Identity | It shows unique clock identifier |
| • Dom | Clock domain [0..127]. |
| • Clock Quality | The clock quality is determined by the system, and holds 3 parts: Clock Class, Clock Accuracy and OffsetScaledLog Variance as defined in IEEE1588. The Clock Accuracy values are defined in IEEE1588 table 6 (Currently the clock Accuracy is set to 'Unknown' as default). |
| • Pri1 | Clock priority 1 [0..255] used by the BMC master select algorithm. |
| • Pri2 | Clock priority 2 [0..255] used by the BMC master select algorithm. |
| • Protocol | Transport protocol used by the PTP protocol engine ethernet PTP over Ethernet multicast ip4multi PTP over IPv4 multicast ip4uni PTP over IPv4 unicast |

| | |
|--|---|
| <ul style="list-style-type: none"> • One-Way | If true, one way measurements are used. This parameter applies only to a slave. In one-way mode no delay measurements are performed, i.e. this is applicable only if frequency synchronization is needed. The master always responds to delay requests. |
| <ul style="list-style-type: none"> • VLAN Tag Enable | Enables the VLAN tagging for the PTP frames. |
| <ul style="list-style-type: none"> • VID | VLAN Identifier used for tagging the VLAN packets. |
| <ul style="list-style-type: none"> • PCP | Priority Code Point value used for PTP frames. |

Clock current Data Set

| Object | Description |
|---|---|
| <ul style="list-style-type: none"> • stpRm | Steps Removed : It is the number of PTP clocks traversed from the grandmaster to the local slave clock. |
| <ul style="list-style-type: none"> • Offset from master | Time difference between the master clock and the local slave clock, measured in ns. |
| <ul style="list-style-type: none"> • Mean Path Delay | The mean propagation time for the link between the master and the local slave |

Clock Parent Data Set

| Object | Description |
|---|---|
| <ul style="list-style-type: none"> • Parent Port Identity | Clock identity for the parent clock, if the local clock is not a slave, the value is the clocks own id. |
| <ul style="list-style-type: none"> • Port | Port Id for the parent master port |
| <ul style="list-style-type: none"> • P Stat | Parents Stats (always false). |
| <ul style="list-style-type: none"> • Var | It is observed parent offset scaled log variance |
| <ul style="list-style-type: none"> • Change Rate | Observed Parent Clock Phase Change Rate. i.e. the slave clocks rate offset compared to the master. (unit = ns per s). |
| <ul style="list-style-type: none"> • Grand Master Identity | Clock identity for the grand master clock, if the local clock is not a slave, the value is the clocks own id. |
| <ul style="list-style-type: none"> • Grand Master Clock Quality | The clock quality announced by the grand master (See description of Clock Default Data Set: Clock Quality) |
| <ul style="list-style-type: none"> • Pri1 | Clock priority 1 announced by the grand master |
| <ul style="list-style-type: none"> • Pri2 | Clock priority 2 announced by the grand master |

Servo Parameters

| Object | Description |
|-------------------|---|
| • Display | If true then Offset From Master, MeanPathDelay and clockAdjustment are logged on the debug terminal |
| • P-enable | If true the P part of the algorithm is included |
| • I-enable | If true the I part of the algorithm is included |
| • D-enable | If true the D part of the algorithm is included |
| 'P' constant | [1..1000] see above |
| • 'I' constant | [1..1000] see above |
| 'D' constant | [1..1000] see above |

Unicast Slave Configuration

| Object | Description |
|---------------------|--|
| • Duration | The number of seconds a master is requested to send Announce/Sync messages. The request is repeated from the slave each Duration/4 seconds. |
| • Ip-address | IPv4 Address of the Master clock |
| • grant | The granted repetition period for the sync message |
| • Comm State | The state of the communication with the master, possible values are: <ul style="list-style-type: none"> ■ IDLE : The entry is not in use. ■ INIT : Announce is sent to the master (Waiting for a response). ■ CONN : The master has responded. ■ SELL : The assigned master is selected as current master. ■ SYNC : The master is sending Sync messages. |

Buttons

 : Click to apply changes

 : Click to undo any changes made locally and revert to previously saved values

4.4 Quality of Service

4.4.1 General

Quality of Service (QoS) is an advanced traffic prioritization feature that allows you to establish control over network traffic. QoS enables you to assign various grades of network service to different types of traffic, such as multi-media, video, protocol-specific, time critical, and file-backup traffic.

QoS reduces bandwidth limitations, delay, loss, and jitter. It also provides increased reliability for delivery of your data and allows you to prioritize certain applications across your network. You can define exactly how you want the switch to treat selected applications and types of traffic. You can use QoS on your system to:

- Control a wide variety of network traffic by:
- Classifying traffic based on packet attributes.
- Assigning priorities to traffic (for example, to set higher priorities to time-critical or business-critical applications).
- Applying security policy through traffic filtering.
- Provide predictable throughput for multimedia applications such as video conferencing or voice over IP by minimizing delay and jitter.
- Improve performance for specific types of traffic and preserve performance as the amount of traffic grows.
- Reduce the need to constantly add bandwidth to the network.
- Manage network congestion.

QoS Terminology

- **Classifier**—classifies the traffic on the network. Traffic classifications are determined by protocol, application, source, destination, and so on. You can create and modify classifications. The Switch then groups classified traffic in order to schedule them with the appropriate service level.
- **DiffServ Code Point (DSCP)** — is the traffic prioritization bits within an IP header that are encoded by certain applications and/or devices to indicate the level of service required by the packet across a network.
- **Service Level**—defines the priority that will be given to a set of classified traffic. You can create and modify service levels.
- **Policy**—comprises a set of “rules” that are applied to a network so that a network meets the needs of the business. That is, traffic can be prioritized across a network according to its importance to that particular business type.
- **QoS Profile**—consists of multiple sets of rules (classifier plus service level combinations). The QoS profile is assigned to a port(s).
- **Rules**—comprises a service level and a classifier to define how the Switch will treat certain types of traffic. Rules are associated with a QoS Profile (see above).

To implement QoS on your network, you need to carry out the following actions:

1. Define a service level to determine the priority that will be applied to traffic.
2. Apply a classifier to determine how the incoming traffic will be classified and thus treated by the Switch.
3. Create a QoS profile which associates a service level and a classifier.
4. Apply a QoS profile to a port(s).

4.4.1.1 QoS Port Classification

This page allows you to configure the basic QoS Classification settings for all switch ports. The Port classification screen in Figure 4-4-1-1 appears.

QoS Port Classification

| Port | Ingress | | | | | | | | | Egress |
|------|---------|---------|---------|---------|---------|------------|--------------------------|------------|-----|--------|
| | CoS | DPL | PCP | DEI | CoS ID | Tag Class. | DSCP Based | WRED Group | Map | Map |
| * | <All> ▼ | <All> ▼ | <All> ▼ | <All> ▼ | <All> ▼ | | <input type="checkbox"/> | <All> ▼ | | |
| 1 | 0 ▼ | 0 ▼ | 0 ▼ | 0 ▼ | 0 ▼ | Disabled | <input type="checkbox"/> | 1 ▼ | | |
| 2 | 0 ▼ | 0 ▼ | 0 ▼ | 0 ▼ | 0 ▼ | Disabled | <input type="checkbox"/> | 1 ▼ | | |
| 3 | 0 ▼ | 0 ▼ | 0 ▼ | 0 ▼ | 0 ▼ | Disabled | <input type="checkbox"/> | 1 ▼ | | |
| 4 | 0 ▼ | 0 ▼ | 0 ▼ | 0 ▼ | 0 ▼ | Disabled | <input type="checkbox"/> | 1 ▼ | | |
| 5 | 0 ▼ | 0 ▼ | 0 ▼ | 0 ▼ | 0 ▼ | Disabled | <input type="checkbox"/> | 1 ▼ | | |
| 6 | 0 ▼ | 0 ▼ | 0 ▼ | 0 ▼ | 0 ▼ | Disabled | <input type="checkbox"/> | 1 ▼ | | |
| 7 | 0 ▼ | 0 ▼ | 0 ▼ | 0 ▼ | 0 ▼ | Disabled | <input type="checkbox"/> | 1 ▼ | | |
| 8 | 0 ▼ | 0 ▼ | 0 ▼ | 0 ▼ | 0 ▼ | Disabled | <input type="checkbox"/> | 1 ▼ | | |
| 9 | 0 ▼ | 0 ▼ | 0 ▼ | 0 ▼ | 0 ▼ | Disabled | <input type="checkbox"/> | 1 ▼ | | |
| 10 | 0 ▼ | 0 ▼ | 0 ▼ | 0 ▼ | 0 ▼ | Disabled | <input type="checkbox"/> | 1 ▼ | | |

Figure 4-4-1-1: QoS Ingress Port Policers Page Screenshot

The page includes the following fields:

| Object | Description |
|---|---|
| <ul style="list-style-type: none"> • Port | The port number for which the configuration below applies. |
| <ul style="list-style-type: none"> • CoS | <p>Controls the default CoS value.</p> <p>All frames are classified to a CoS. There is a one to one mapping between CoS, queue and priority. A CoS of 0 (zero) has the lowest priority.</p> <p>The classified CoS can be overruled by a QCL entry.</p> <p>Note: If the default CoS has been dynamically changed, then the actual default CoS is shown in parentheses after the configured default CoS.</p> |
| <ul style="list-style-type: none"> • DPL | Controls the default DPL value. |

| | |
|--|---|
| | <p>All frames are classified to a Drop Precedence Level.</p> <p>The classified DPL can be overruled by a QCL entry.</p> |
| <ul style="list-style-type: none"> • PCP | <p>Controls the default PCP value.</p> <p>All frames are classified to a PCP value.</p> <p>If the port is VLAN aware and the frame is tagged, then the frame is classified to the PCP value in the tag. Otherwise the frame is classified to the default PCP value.</p> |
| <ul style="list-style-type: none"> • DEI | <p>Controls the default DEI value.</p> <p>All frames are classified to a DEI value.</p> <p>If the port is VLAN aware and the frame is tagged, then the frame is classified to the DEI value in the tag. Otherwise the frame is classified to the default DEI value.</p> |
| <ul style="list-style-type: none"> • CoS ID | <p>Controls the default CoS ID value.</p> <p>Every incoming frame is classified to a CoS ID, which later can be used as basis for rewriting of different parts of the frame.</p> |
| <ul style="list-style-type: none"> • Tag Class. | <p>Shows the classification mode for tagged frames on this port.</p> <p>Disabled: Use default CoS and DPL for tagged frames.</p> <p>Enabled: Use mapped versions of PCP and DEI for tagged frames.</p> <p>Click on the mode in order to configure the mode and/or mapping.</p> <p>Note: This setting has no effect if the port is VLAN unaware. Tagged frames received on VLAN unaware ports are always classified to the default CoS and DPL.</p> |
| <ul style="list-style-type: none"> • DSCP Based | <p>Click to Enable DSCP Based QoS Ingress Port Classification.</p> |
| <ul style="list-style-type: none"> • WRED Group | <p>Controls the WRED group membership.</p> |
| <ul style="list-style-type: none"> • Ingress Map | <p>Controls the Ingress Map selection through the Map ID. The Ingress Map ID ranges from 0 to 255. An empty field indicates no map selection.</p> |
| <ul style="list-style-type: none"> • Egress Map | <p>Controls the Egress Map selection through the Map ID. The Egress Map ID ranges from 0 to 511. An empty field indicates no map selection.</p> |

Buttons

 : Click to apply changes

Reset: Click to undo any changes made locally and revert to previously saved values.

4.4.1.2 Queue Policing

This page allows you to configure the Queue Policer settings for all switch ports.. The Queue Policing screen in [Figure 4-4-1-2](#) appears.

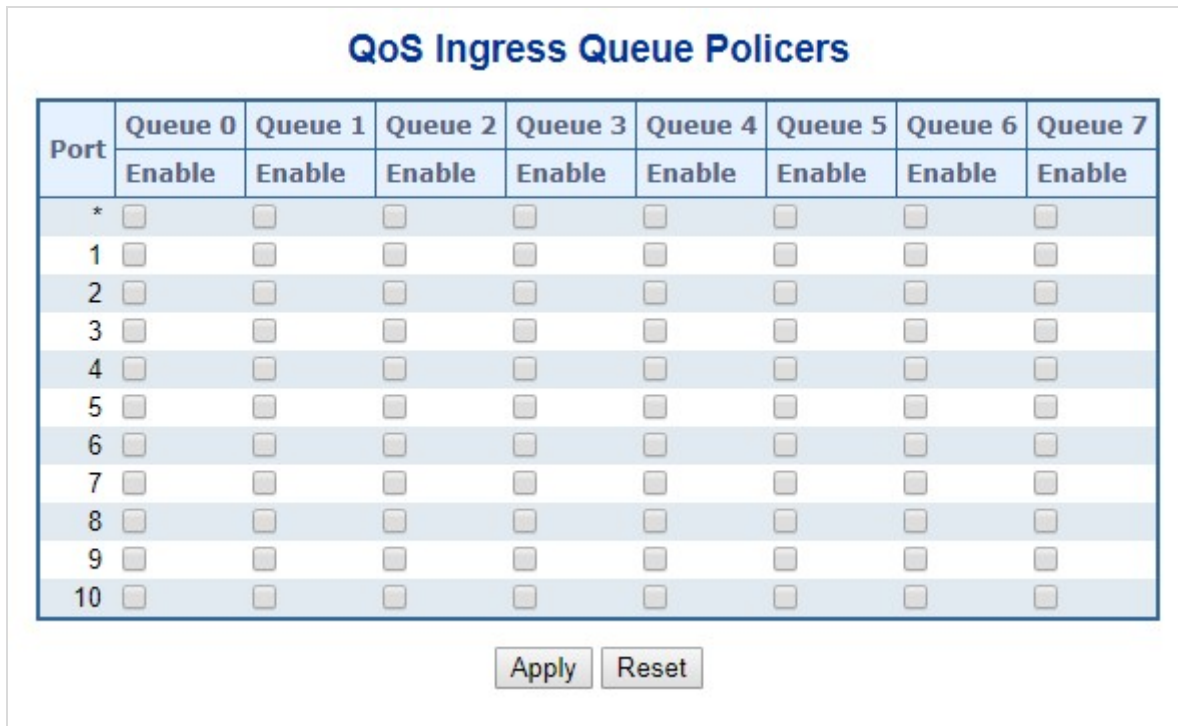

| Port | Queue 0 | Queue 1 | Queue 2 | Queue 3 | Queue 4 | Queue 5 | Queue 6 | Queue 7 |
|------|--------------------------|--------------------------|--------------------------|--------------------------|--------------------------|--------------------------|--------------------------|--------------------------|
| | Enable | Enable | Enable | Enable | Enable | Enable | Enable | Enable |
| * | <input type="checkbox"/> | <input type="checkbox"/> | <input type="checkbox"/> | <input type="checkbox"/> | <input type="checkbox"/> | <input type="checkbox"/> | <input type="checkbox"/> | <input type="checkbox"/> |
| 1 | <input type="checkbox"/> | <input type="checkbox"/> | <input type="checkbox"/> | <input type="checkbox"/> | <input type="checkbox"/> | <input type="checkbox"/> | <input type="checkbox"/> | <input type="checkbox"/> |
| 2 | <input type="checkbox"/> | <input type="checkbox"/> | <input type="checkbox"/> | <input type="checkbox"/> | <input type="checkbox"/> | <input type="checkbox"/> | <input type="checkbox"/> | <input type="checkbox"/> |
| 3 | <input type="checkbox"/> | <input type="checkbox"/> | <input type="checkbox"/> | <input type="checkbox"/> | <input type="checkbox"/> | <input type="checkbox"/> | <input type="checkbox"/> | <input type="checkbox"/> |
| 4 | <input type="checkbox"/> | <input type="checkbox"/> | <input type="checkbox"/> | <input type="checkbox"/> | <input type="checkbox"/> | <input type="checkbox"/> | <input type="checkbox"/> | <input type="checkbox"/> |
| 5 | <input type="checkbox"/> | <input type="checkbox"/> | <input type="checkbox"/> | <input type="checkbox"/> | <input type="checkbox"/> | <input type="checkbox"/> | <input type="checkbox"/> | <input type="checkbox"/> |
| 6 | <input type="checkbox"/> | <input type="checkbox"/> | <input type="checkbox"/> | <input type="checkbox"/> | <input type="checkbox"/> | <input type="checkbox"/> | <input type="checkbox"/> | <input type="checkbox"/> |
| 7 | <input type="checkbox"/> | <input type="checkbox"/> | <input type="checkbox"/> | <input type="checkbox"/> | <input type="checkbox"/> | <input type="checkbox"/> | <input type="checkbox"/> | <input type="checkbox"/> |
| 8 | <input type="checkbox"/> | <input type="checkbox"/> | <input type="checkbox"/> | <input type="checkbox"/> | <input type="checkbox"/> | <input type="checkbox"/> | <input type="checkbox"/> | <input type="checkbox"/> |
| 9 | <input type="checkbox"/> | <input type="checkbox"/> | <input type="checkbox"/> | <input type="checkbox"/> | <input type="checkbox"/> | <input type="checkbox"/> | <input type="checkbox"/> | <input type="checkbox"/> |
| 10 | <input type="checkbox"/> | <input type="checkbox"/> | <input type="checkbox"/> | <input type="checkbox"/> | <input type="checkbox"/> | <input type="checkbox"/> | <input type="checkbox"/> | <input type="checkbox"/> |

Figure 4-4-1-2 : QoS Ingress Port Classification Page Screenshot

The page includes the following fields:

| Object | Description |
|---------------------|---|
| • Port | The port number for which the configuration below applies. |
| • Enable (E) | Enable or disable the queue policer for this switch port. |
| • Rate | Controls the rate for the queue policer. This value is restricted to 25-13128147 when "Unit" is kbps, and 1-13128 when "Unit" is Mbps. The rate is internally rounded up to the nearest value supported by the queue policer. This field is only shown if at least one of the queue policers are enabled. |
| • Unit | Controls the unit of measure for the queue policer rate as kbps or Mbps. This field is only shown if at least one of the queue policers are enabled. |

Buttons

Apply: Click to apply changes

Reset: Click to undo any changes made locally and revert to previously saved values.

4.4.1.3 Port Tag Remarking

This page provides an overview of QoS Egress Port Tag Remarking for all switch ports. The Port tag remarking screen in [Figure 4-4-1-3](#) appears.

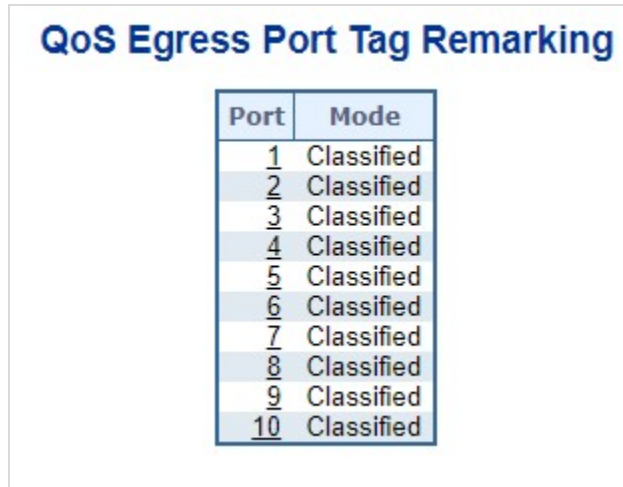

| Port | Mode |
|------|------------|
| 1 | Classified |
| 2 | Classified |
| 3 | Classified |
| 4 | Classified |
| 5 | Classified |
| 6 | Classified |
| 7 | Classified |
| 8 | Classified |
| 9 | Classified |
| 10 | Classified |

Figure 4-4-1-3: Port Tag Remarking Page Screenshot

The page includes the following fields:

| Object | Description |
|---|--|
| <ul style="list-style-type: none"> • Port | <p>he logical port for the settings contained in the same row.</p> <p>Click on the port number in order to configure tag remarking</p> |
| <ul style="list-style-type: none"> • Mode | <p>Shows the tag remarking mode for this port.</p> <p>Classified: Use classified PCP/DEI values.</p> <p>Default: Use default PCP/DEI values.</p> <p>Mapped: Use mapped versions of CoS and DPL.</p> |

4.4.1.4 WERD

This page allows you to configure the Random Early Detection (RED) settings.. The Port Shaper screen in [Figure 4-4-4](#) appears.

| Group | Queue | DPL | Enable | Min | Max | Max Unit |
|-------|-------|-----|-------------------------------------|-----|-----|--------------------|
| 1 | 0 | 1 | <input type="checkbox"/> | 0 | 0 | Drop Probability ▼ |
| 1 | 0 | 2 | <input type="checkbox"/> | 0 | 0 | Drop Probability ▼ |
| 1 | 0 | 3 | <input type="checkbox"/> | 46 | 112 | Drop Probability ▼ |
| 1 | 1 | 1 | <input checked="" type="checkbox"/> | 226 | 197 | Drop Probability ▼ |
| 1 | 1 | 2 | <input type="checkbox"/> | 0 | 0 | Drop Probability ▼ |
| 1 | 1 | 3 | <input type="checkbox"/> | 0 | 0 | Drop Probability ▼ |
| 1 | 2 | 1 | <input checked="" type="checkbox"/> | 0 | 0 | Drop Probability ▼ |
| 1 | 2 | 2 | <input type="checkbox"/> | 0 | 0 | Drop Probability ▼ |
| 1 | 2 | 3 | <input checked="" type="checkbox"/> | 145 | 255 | Drop Probability ▼ |
| 1 | 3 | 1 | <input checked="" type="checkbox"/> | 223 | 197 | Drop Probability ▼ |
| | | | <input type="checkbox"/> | 0 | 0 | Drop Probability ▼ |

Figure 4-4-1-4: QoS Egress Port Shapers Page Screenshot

The page includes the following fields:

| Object | Description |
|-------------------|--|
| • Group | The WRED group number for which the configuration below applies. |
| • Queue | The queue number (CoS) for which the configuration below applies. |
| • DPL | The Drop Precedence Level for which the configuration below applies. |
| • Enable | Controls whether RED is enabled for this entry. |
| • Min | Controls the lower RED fill level threshold. If the queue filling level is below this threshold, the drop probability is zero. This value is restricted to 0-100%. |
| • Max | Controls the upper RED drop probability or fill level threshold for frames marked with Drop Precedence Level > 0 (yellow frames). This value is restricted to 1-100%. |
| • Max Unit | Selects the unit for Max. Possible values are: Drop Probability : Max controls the drop probability just below 100% fill level. Fill Level : Max controls the fill level where drop probability reaches 100%.. |

Buttons

: Click to apply changes

: Click to undo any changes made locally and revert to previously saved values.

4.4.1.5 Statistics

This page provides statistics for the different queues for all switch ports. The statistic screen in [Figure 4-4-1-5](#) appears.

| Queuing Counters | | | | | | | | | | | | | | | | |
|---|---------|---------|----|----|----|----|----|----|----|----|----|----|----|----|----|------|
| Auto-refresh <input type="checkbox"/> Refresh Clear | | | | | | | | | | | | | | | | |
| Port | Q0 | | Q1 | | Q2 | | Q3 | | Q4 | | Q5 | | Q6 | | Q7 | |
| | Rx | Tx | Rx | Tx | Rx | Tx | Rx | Tx | Rx | Tx | Rx | Tx | Rx | Tx | Rx | Tx |
| 1 | 0 | 0 | 0 | 0 | 0 | 0 | 0 | 0 | 0 | 0 | 0 | 0 | 0 | 0 | 0 | 0 |
| 2 | 26828 | 6284130 | 0 | 0 | 0 | 0 | 0 | 0 | 0 | 0 | 0 | 0 | 0 | 0 | 0 | 2244 |
| 3 | 0 | 0 | 0 | 0 | 0 | 0 | 0 | 0 | 0 | 0 | 0 | 0 | 0 | 0 | 0 | 0 |
| 4 | 0 | 0 | 0 | 0 | 0 | 0 | 0 | 0 | 0 | 0 | 0 | 0 | 0 | 0 | 0 | 0 |
| 5 | 0 | 0 | 0 | 0 | 0 | 0 | 0 | 0 | 0 | 0 | 0 | 0 | 0 | 0 | 0 | 0 |
| 6 | 0 | 0 | 0 | 0 | 0 | 0 | 0 | 0 | 0 | 0 | 0 | 0 | 0 | 0 | 0 | 0 |
| 7 | 0 | 0 | 0 | 0 | 0 | 0 | 0 | 0 | 0 | 0 | 0 | 0 | 0 | 0 | 0 | 0 |
| 8 | 0 | 0 | 0 | 0 | 0 | 0 | 0 | 0 | 0 | 0 | 0 | 0 | 0 | 0 | 0 | 0 |
| 9 | 5785758 | 5778763 | 0 | 0 | 0 | 0 | 0 | 0 | 0 | 0 | 0 | 0 | 0 | 0 | 0 | 1013 |
| 10 | 5779738 | 5784794 | 0 | 0 | 0 | 0 | 0 | 0 | 0 | 0 | 0 | 0 | 0 | 0 | 0 | 1012 |

Figure 4-4-1-5: QoS statistics Page Screenshot

The page includes the following fields:

| Object | Description |
|---------|---|
| • Port | The logical port for the settings contained in the same row. |
| • Qn | There are 8 QoS queues per port. Q0 is the lowest priority queue. |
| • Rx/Tx | The number of received and transmitted packets per queue. |

Buttons

Refresh : Click to refresh the page immediately.

Clear : Clears the counters for all ports

4.4.2 Bandwidth Control

4.4.2.1 Port Policing

This page allows you to configure the Policer settings for all switch ports. The Port Policing screen in [Figure 4-4-2-1](#) appears.

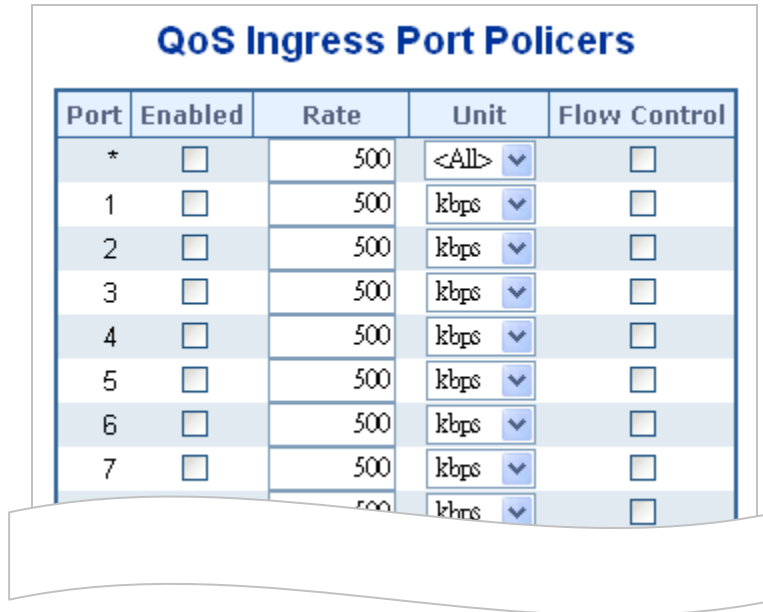

| Port | Enabled | Rate | Unit | Flow Control |
|------|--------------------------|------|-------|--------------------------|
| * | <input type="checkbox"/> | 500 | <All> | <input type="checkbox"/> |
| 1 | <input type="checkbox"/> | 500 | kbps | <input type="checkbox"/> |
| 2 | <input type="checkbox"/> | 500 | kbps | <input type="checkbox"/> |
| 3 | <input type="checkbox"/> | 500 | kbps | <input type="checkbox"/> |
| 4 | <input type="checkbox"/> | 500 | kbps | <input type="checkbox"/> |
| 5 | <input type="checkbox"/> | 500 | kbps | <input type="checkbox"/> |
| 6 | <input type="checkbox"/> | 500 | kbps | <input type="checkbox"/> |
| 7 | <input type="checkbox"/> | 500 | kbps | <input type="checkbox"/> |

Figure 4-4-2-1: QoS Ingress Port Policers Page Screenshot

The page includes the following fields:

| Object | Description |
|-----------------------|---|
| • Port | The port number for which the configuration below applies. |
| • Enable | Controls whether the policer is enabled on this switch port. |
| • Rate | Controls the rate for the policer. This value is restricted to 100-1000000 when the "Unit" is "kbps" or "fps", and it is restricted to 1-3300 when the "Unit" is "Mbps" or "kfps". The default value is 500 . |
| • Unit | Controls the unit of measure for the policer rate as kbps , Mbps , fps or kfps . The default value is "kbps". |
| • Flow Control | If flow control is enabled and the port is in flow control mode, then pause frames are sent instead of discarding frames. |

Buttons

 : Click to apply changes

 : Click to undo any changes made locally and revert to previously saved values.

4.4.2.2 Port Schedule

The Port Scheduler and Shapers for a specific port are configured on this page. The QoS Egress Port Schedule and Shaper screen in [Figure 4-4-2-2](#) appears.

| QoS Egress Port Schedulers | | | | | | | | | |
|----------------------------|-----------------|--------|----|----|----|----|----|----|----|
| Port | Mode | Weight | | | | | | | |
| | | Q0 | Q1 | Q2 | Q3 | Q4 | Q5 | Q6 | Q7 |
| 1 | Strict Priority | - | - | - | - | - | - | - | - |
| 2 | Strict Priority | - | - | - | - | - | - | - | - |
| 3 | Strict Priority | - | - | - | - | - | - | - | - |
| 4 | Strict Priority | - | - | - | - | - | - | - | - |
| 5 | Strict Priority | - | - | - | - | - | - | - | - |
| 6 | Strict Priority | - | - | - | - | - | - | - | - |
| 7 | Strict Priority | - | - | - | - | - | - | - | - |
| 8 | Strict Priority | - | - | - | - | - | - | - | - |
| 9 | Strict Priority | - | - | - | - | - | - | - | - |
| 10 | Strict Priority | - | - | - | - | - | - | - | - |

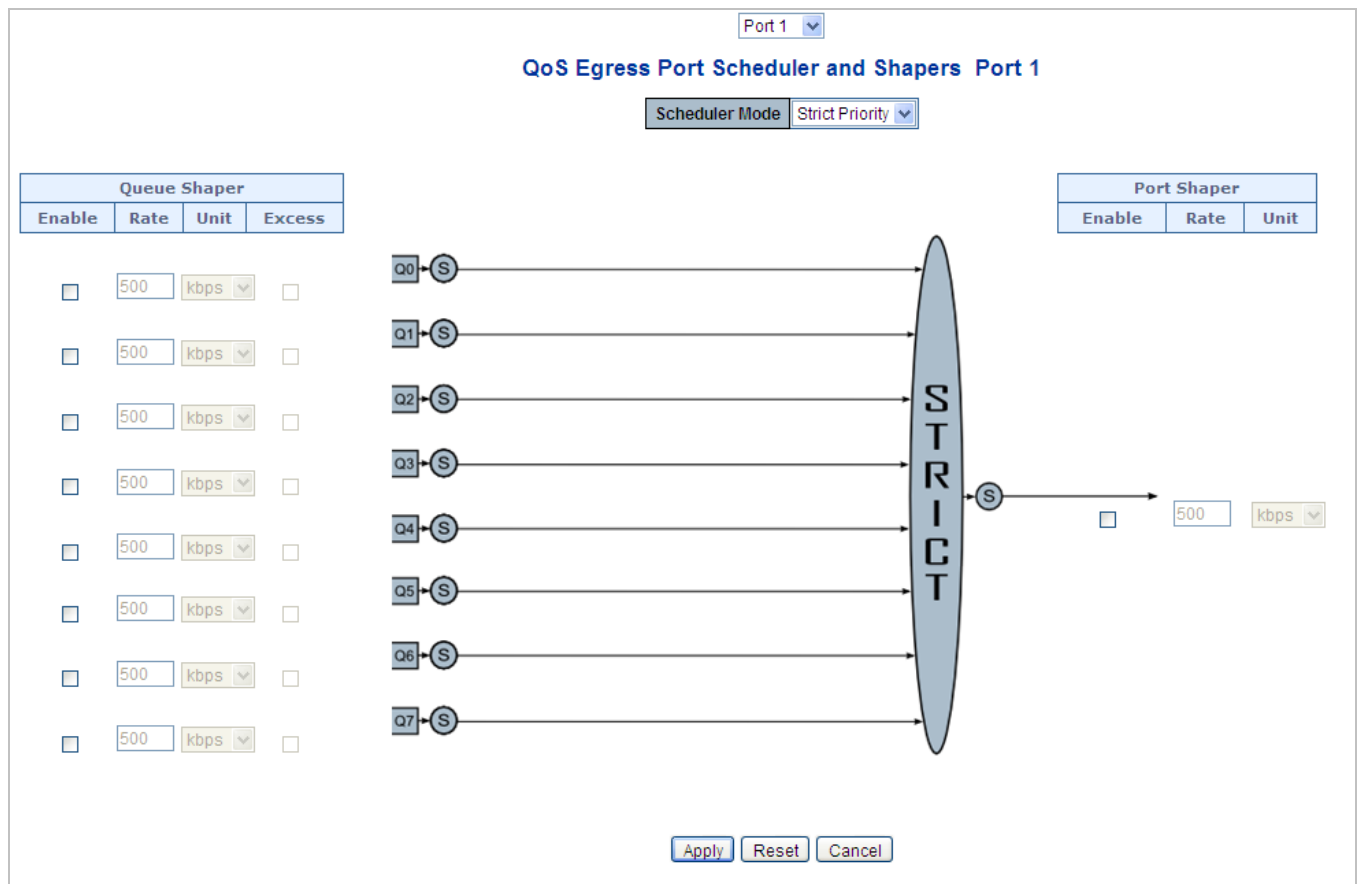

Figure 4-4-2-2: QoS Egress Port Schedule and Shapers Page Screenshot

The page includes the following fields:

| Object | Description |
|--------|-------------|
|--------|-------------|

| | |
|----------------------------------|---|
| • Schedule Mode | Controls whether the scheduler mode is " Strict Priority " or " Weighted " on this switch port. |
| • Queue Shaper Enable | Controls whether the queue shaper is enabled for this queue on this switch port. |
| • Queue Shaper Rate | Controls the rate for the queue shaper. This value is restricted to 100-1000000 when the "Unit" is "kbps", and it is restricted to 1-13200 when the "Unit" is "Mbps". The default value is 500 . |
| • Queue Shaper Unit | Controls the unit of measure for the queue shaper rate as " kbps " or " Mbps ". The default value is "kbps". |
| • Queue Shaper Excess | Controls whether the queue is allowed to use excess bandwidth. |
| • Queue Scheduler Weight | Controls the weight for this queue. This value is restricted to 1-100. This parameter is only shown if "Scheduler Mode" is set to " Weighted ". The default value is " 17 ". |
| • Queue Scheduler Percent | Shows the weight in percent for this queue. This parameter is only shown if "Scheduler Mode" is set to "Weighted". |
| • Port Shaper Enable | Controls whether the port shaper is enabled for this switch port. |
| • Port Shaper Rate | Controls the rate for the port shaper. This value is restricted to 100-1000000 when the "Unit" is "kbps", and it is restricted to 1-13200 when the "Unit" is "Mbps". The default value is 500. |
| • Port Shaper Unit | Controls the unit of measure for the port shaper rate as "kbps" or "Mbps". The default value is "kbps". |

Buttons

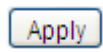
: Click to apply changes

: Click to undo any changes made locally and revert to previously saved values.

: Click to undo any changes made locally and return to the previous page.

4.4.2.3 Port Shaping

This page provides an overview of QoS Egress Port Shapers for all switch ports. The Port shaping screen in [Figure 4-4-2-3](#) appears.

QoS Egress Port Shapers

| Port | Shapers | | | | | | | | Port |
|------|---------|----|----|----|----|----|----|----|------|
| | Q0 | Q1 | Q2 | Q3 | Q4 | Q5 | Q6 | Q7 | |
| 1 | - | - | - | - | - | - | - | - | - |
| 2 | - | - | - | - | - | - | - | - | - |
| 3 | - | - | - | - | - | - | - | - | - |
| 4 | - | - | - | - | - | - | - | - | - |
| 5 | - | - | - | - | - | - | - | - | - |
| 6 | - | - | - | - | - | - | - | - | - |
| 7 | - | - | - | - | - | - | - | - | - |
| 8 | - | - | - | - | - | - | - | - | - |
| 9 | - | - | - | - | - | - | - | - | - |
| 10 | - | - | - | - | - | - | - | - | - |

Port 1

QoS Egress Port Scheduler and Shapers Port 1

Scheduler Mode Strict Priority

| Queue Shaper | | | |
|--------------------------|------|------|--------------------------|
| Enable | Rate | Unit | Excess |
| <input type="checkbox"/> | 500 | kbps | <input type="checkbox"/> |
| <input type="checkbox"/> | 500 | kbps | <input type="checkbox"/> |
| <input type="checkbox"/> | 500 | kbps | <input type="checkbox"/> |
| <input type="checkbox"/> | 500 | kbps | <input type="checkbox"/> |
| <input type="checkbox"/> | 500 | kbps | <input type="checkbox"/> |
| <input type="checkbox"/> | 500 | kbps | <input type="checkbox"/> |
| <input type="checkbox"/> | 500 | kbps | <input type="checkbox"/> |
| <input type="checkbox"/> | 500 | kbps | <input type="checkbox"/> |
| <input type="checkbox"/> | 500 | kbps | <input type="checkbox"/> |

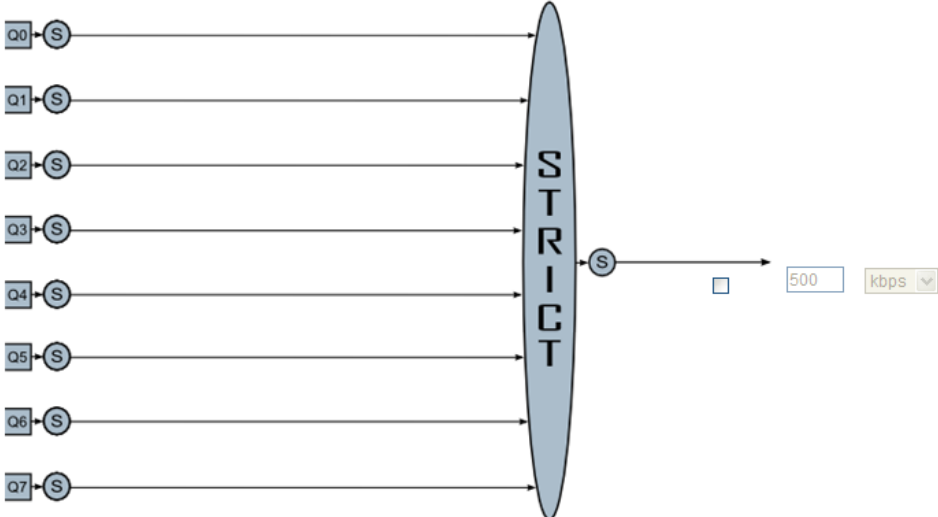

| Port Shaper | | |
|--------------------------|------|------|
| Enable | Rate | Unit |
| <input type="checkbox"/> | 500 | kbps |

Apply Reset Cancel

Figure 4-4-2-3: QoS Egress Port Schedule and Shapers Page Screenshot

The page includes the following fields:

| Object | Description |
|--|---|
| <ul style="list-style-type: none"> Schedule Mode | Controls whether the scheduler mode is "Strict Priority" or "Weighted" on this switch port. |
| <ul style="list-style-type: none"> Queue Shaper Enable | Controls whether the queue shaper is enabled for this queue on this switch port. |
| <ul style="list-style-type: none"> Queue Shaper Rate | Controls the rate for the queue shaper. |

| | |
|--|---|
| | <p>This value is restricted to 100-1000000 when the "Unit" is "kbps", and it is restricted to 1-13200 when the "Unit" is "Mbps".</p> <p>The default value is 500.</p> |
| <ul style="list-style-type: none"> • Queue Shaper Unit | <p>Controls the unit of measure for the queue shaper rate as "kbps" or "Mbps".</p> <p>The default value is "kbps".</p> |
| <ul style="list-style-type: none"> • Queue Shaper Excess | <p>Controls whether the queue is allowed to use excess bandwidth.</p> |
| <ul style="list-style-type: none"> • Queue Scheduler Weight | <p>Controls the weight for this queue.</p> <p>This value is restricted to 1-100. This parameter is only shown if "Scheduler Mode" is set to "Weighted".</p> <p>The default value is "17".</p> |
| <ul style="list-style-type: none"> • Queue Scheduler Percent | <p>Shows the weight in percent for this queue. This parameter is only shown if "Scheduler Mode" is set to "Weighted".</p> |
| <ul style="list-style-type: none"> • Port Shaper Enable | <p>Controls whether the port shaper is enabled for this switch port.</p> |
| <ul style="list-style-type: none"> • Port Shaper Rate | <p>Controls the rate for the port shaper.</p> <p>This value is restricted to 100-1000000 when the "Unit" is "kbps", and it is restricted to 1-13200 when the "Unit" is "Mbps".</p> <p>The default value is 500.</p> |
| <ul style="list-style-type: none"> • Port Shaper Unit | <p>Controls the unit of measure for the port shaper rate as "kbps" or "Mbps".</p> <p>The default value is "kbps".</p> |

Buttons

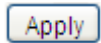

: Click to apply changes

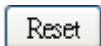

: Click to undo any changes made locally and revert to previously saved values.

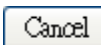

: Click to undo any changes made locally and return to the previous page.

4.4.3 Storm Control

4.4.3.1 Storm Policing Configuration

Storm control for the switch is configured on this page. There is a unicast storm rate control, multicast storm rate control, and a broadcast storm rate control. These only affect flooded frames, i.e. frames with a (VLAN ID, DMAC) pair not present on the MAC Address table.

The configuration indicates the permitted packet rate for unicast, multicast or broadcast traffic across the switch.

The Storm Control Configuration screen in [Figure 4-4-3-1](#) appears.

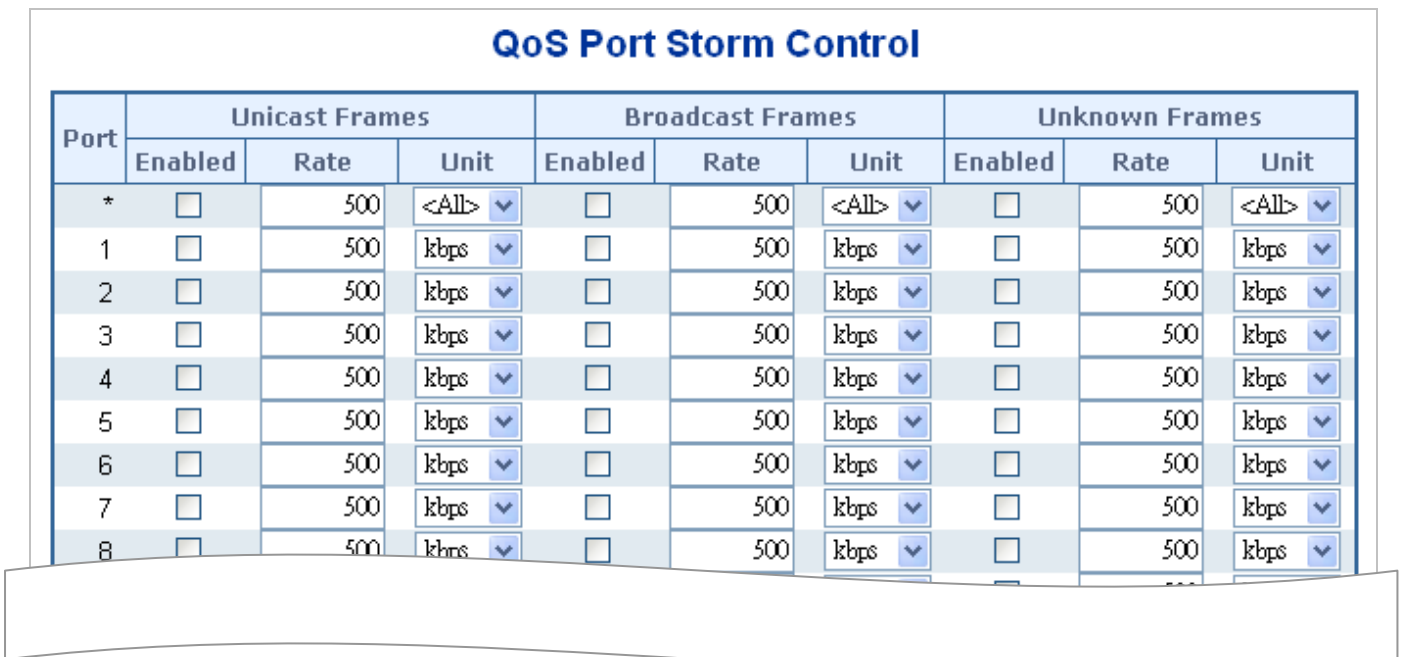

| Port | Unicast Frames | | | Broadcast Frames | | | Unknown Frames | | |
|------|--------------------------|------|-------|--------------------------|------|-------|--------------------------|------|-------|
| | Enabled | Rate | Unit | Enabled | Rate | Unit | Enabled | Rate | Unit |
| * | <input type="checkbox"/> | 500 | <All> | <input type="checkbox"/> | 500 | <All> | <input type="checkbox"/> | 500 | <All> |
| 1 | <input type="checkbox"/> | 500 | kpbs | <input type="checkbox"/> | 500 | kpbs | <input type="checkbox"/> | 500 | kpbs |
| 2 | <input type="checkbox"/> | 500 | kpbs | <input type="checkbox"/> | 500 | kpbs | <input type="checkbox"/> | 500 | kpbs |
| 3 | <input type="checkbox"/> | 500 | kpbs | <input type="checkbox"/> | 500 | kpbs | <input type="checkbox"/> | 500 | kpbs |
| 4 | <input type="checkbox"/> | 500 | kpbs | <input type="checkbox"/> | 500 | kpbs | <input type="checkbox"/> | 500 | kpbs |
| 5 | <input type="checkbox"/> | 500 | kpbs | <input type="checkbox"/> | 500 | kpbs | <input type="checkbox"/> | 500 | kpbs |
| 6 | <input type="checkbox"/> | 500 | kpbs | <input type="checkbox"/> | 500 | kpbs | <input type="checkbox"/> | 500 | kpbs |
| 7 | <input type="checkbox"/> | 500 | kpbs | <input type="checkbox"/> | 500 | kpbs | <input type="checkbox"/> | 500 | kpbs |
| 8 | <input type="checkbox"/> | 500 | kpbs | <input type="checkbox"/> | 500 | kpbs | <input type="checkbox"/> | 500 | kpbs |

Figure 4-4-3-1: Storm Control Configuration Page Screenshot

The page includes the following fields:

| Object | Description |
|-----------------|---|
| • Port | The port number for which the configuration below applies. |
| • Enable | Controls whether the storm control is enabled on this switch port. |
| • Rate | Controls the rate for the storm control. The default value is 500. This value is restricted to 100-1000000 when the "Unit" is "kpbs" or "fps", and it is restricted to 1-13200 when the "Unit" is "Mbps" or "kfps". |
| • Unit | Controls the unit of measure for the storm control rate as kpbs, Mbps, fps or kfps . The default value is "kpbs". |

Buttons

 : Click to apply changes

 : Click to undo any changes made locally and revert to previously saved values.

4.4.4 Differentiated Service

4.4.4.1 Port DSCP

This page allows you to configure the basic QoS Port DSCP Configuration settings for all switch ports. The Port DSCP screen in [Figure 4-9-8](#) appears.

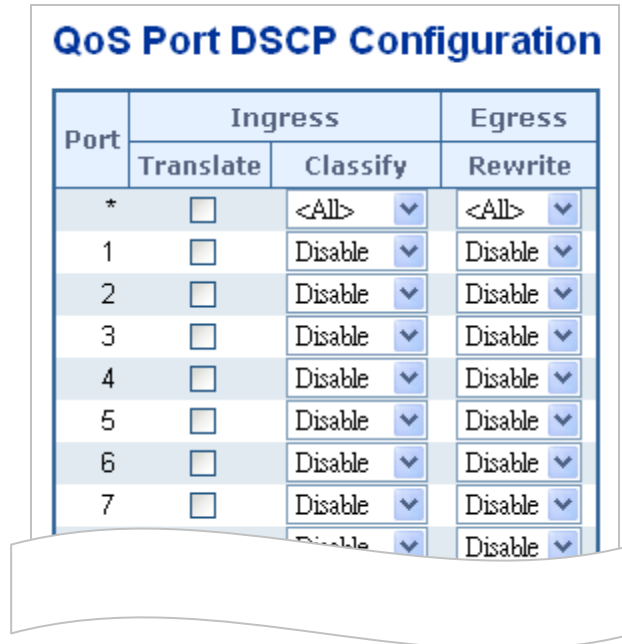

Figure 4-4-4-1: QoS Port DSCP Configuration Page Screenshot

The page includes the following fields:

| Object | Description |
|--|---|
| <ul style="list-style-type: none"> • Port | The Port column shows the list of ports for which you can configure dscp ingress and egress settings. |
| <ul style="list-style-type: none"> • Ingress | <p>In Ingress settings you can change ingress translation and classification settings for individual ports.</p> <p>There are two configuration parameters available in Ingress:</p> <ul style="list-style-type: none"> ■ Translate ■ Classify |
| <ul style="list-style-type: none"> • Translate | To Enable the Ingress Translation click the checkbox. |
| <ul style="list-style-type: none"> • Classify | <p>Classification for a port have 4 different values.</p> <ul style="list-style-type: none"> ■ Disable: No Ingress DSCP Classification. ■ DSCP=0: Classify if incoming (or translated if enabled) DSCP is 0. ■ Selected: Classify only selected DSCP for which classification is enabled as specified in DSCP Translation window for the specific DSCP. ■ All: Classify all DSCP. |
| <ul style="list-style-type: none"> • Egress | <p>Port Egress Rewriting can be one of -</p> <ul style="list-style-type: none"> ■ Disable: No Egress rewrite. |

| | |
|--|---|
| | <ul style="list-style-type: none"> ■ Enable: Rewrite enable without remapped. ■ Remap DP Unaware: DSCP from analyzer is remapped and frame is remarked with remapped DSCP value. The remapped DSCP value is always taken from the 'DSCP Translation->Egress Remap DP0' table. ■ Remap DP Aware: DSCP from analyzer is remapped and frame is remarked with remapped DSCP value. Depending on the DP level of the frame, the remapped DSCP value is either taken from the 'DSCP Translation->Egress Remap DP0' table or from the 'DSCP Translation->Egress Remap DP1' table. |
|--|---|

Buttons



: Click to apply changes



: Click to undo any changes made locally and revert to previously saved values.

4.4.4.2 DSCP-based QoS

This page allows you to configure the basic QoS DSCP-based QoS Ingress Classification settings for all switches. The DSCP-based QoS screen in [Figure 4-4-4-2](#) appears.

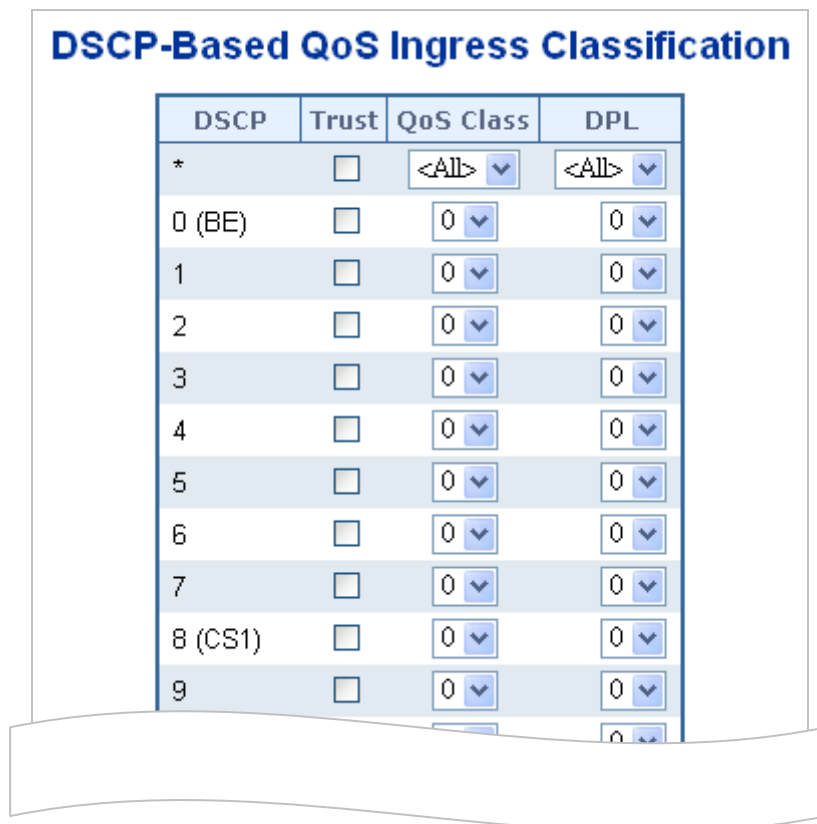

DSCP-Based QoS Ingress Classification

| DSCP | Trust | QoS Class | DPL |
|---------|--------------------------|-----------|---------|
| * | <input type="checkbox"/> | <All> ▾ | <All> ▾ |
| 0 (BE) | <input type="checkbox"/> | 0 ▾ | 0 ▾ |
| 1 | <input type="checkbox"/> | 0 ▾ | 0 ▾ |
| 2 | <input type="checkbox"/> | 0 ▾ | 0 ▾ |
| 3 | <input type="checkbox"/> | 0 ▾ | 0 ▾ |
| 4 | <input type="checkbox"/> | 0 ▾ | 0 ▾ |
| 5 | <input type="checkbox"/> | 0 ▾ | 0 ▾ |
| 6 | <input type="checkbox"/> | 0 ▾ | 0 ▾ |
| 7 | <input type="checkbox"/> | 0 ▾ | 0 ▾ |
| 8 (CS1) | <input type="checkbox"/> | 0 ▾ | 0 ▾ |
| 9 | <input type="checkbox"/> | 0 ▾ | 0 ▾ |

Figure 4-4-4-2: DSCP-based QoS Ingress Classification Page Screenshot

The page includes the following fields:

| Object | Description |
|--------------------|--|
| • DSCP | Maximum number of supported DSCP values are 64. |
| • Trust | Controls whether a specific DSCP value is trusted. Only frames with trusted DSCP values are mapped to a specific QoS class and Drop Precedence Level. Frames with untrusted DSCP values are treated as a non-IP frame. |
| • QoS Class | QoS Class value can be any of (0-7) |
| • DPL | Drop Precedence Level (0-1) |

4.4.4.3 DSCP Translation

This page allows you to configure the basic QoS DSCP Translation settings for all switches. DSCP translation can be done in Ingress or Egress. The DSCP Translation screen in [Figure 4-4-4-3](#) appears.

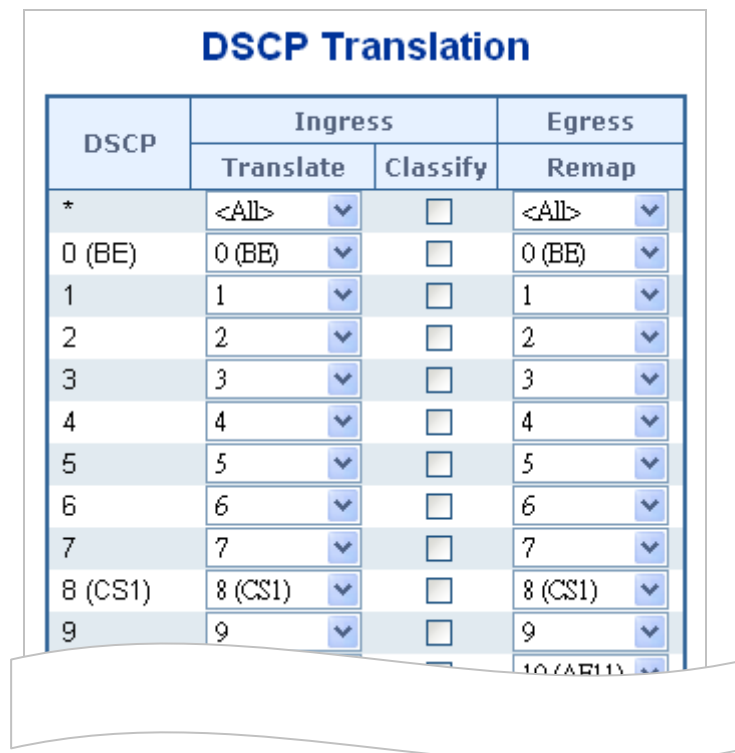
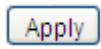

Figure 4-4-4-3: DSCP Translation Page Screenshot

The page includes the following fields:

| Object | Description |
|--|--|
| <ul style="list-style-type: none"> • DSCP | Maximum number of supported DSCP values are 64 and valid DSCP value ranges from 0 to 63. |
| <ul style="list-style-type: none"> • Ingress | <p>Ingress side DSCP can be first translated to new DSCP before using the DSCP for QoS class and DPL map.</p> <p>There are two configuration parameters for DSCP Translation –</p> <ul style="list-style-type: none"> ■ Translate ■ Classify |
| <ul style="list-style-type: none"> • Translate | DSCP at Ingress side can be translated to any of (0-63) DSCP values. |
| <ul style="list-style-type: none"> • Classify | Click to enable Classification at Ingress side. |
| <ul style="list-style-type: none"> • Egress | <p>There is following configurable parameter for Egress side -</p> <ul style="list-style-type: none"> ■ Remap |
| <ul style="list-style-type: none"> • Remap DP | Select the DSCP value from select menu to which you want to remap. DSCP value ranges form 0 to 63. |

Buttons



: Click to apply changes



: Click to undo any changes made locally and revert to previously saved values.

4.4.4.4 DSCP Classification

This page allows you to map DSCP value to a QoS Class and DPL value. The DSCP Classification screen in [Figure 4-4-4-4](#) appears.

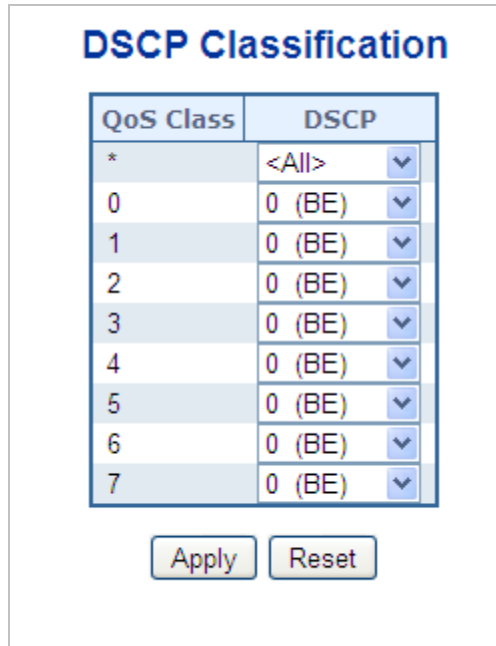



Figure 4-4-4-4: DSCP Classification Page Screenshot

The page includes the following fields:

| Object | Description |
|--|---|
| <ul style="list-style-type: none"> • QoS Class | Available QoS Class value ranges from 0 to 7. QoS Class (0-7) can be mapped to followed parameters. |
| <ul style="list-style-type: none"> • DPL | Actual Drop Precedence Level. |
| <ul style="list-style-type: none"> • DSCP | Select DSCP value (0-63) from DSCP menu to map DSCP to corresponding QoS Class and DPL value |

Buttons

 : Click to apply changes

 : Click to undo any changes made locally and revert to previously saved values.

4.4.5 QCL

4.4.5.1 QoS Control List

This page shows the QoS Control List(QCL), which is made up of the QCEs. Each row describes a QCE that is defined. The maximum number of QCEs is 256 on each switch.

Click on the lowest plus sign to add a new QCE to the list. The QoS Control List screen in [Figure 4-4-5-1](#) appears.

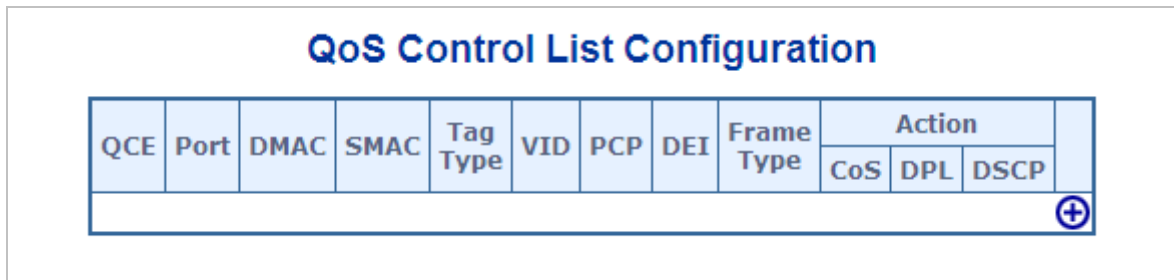







| QCE | Port | DMAC | SMAC | Tag Type | VID | PCP | DEI | Frame Type | Action | | |
|-----|------|------|------|----------|-----|-----|-----|------------|--------|-----|------|
| | | | | | | | | | CoS | DPL | DSCP |
| + | | | | | | | | | | | |

Figure 4-4-5-1: QoS Control List Configuration Page Screenshot

The page includes the following fields:

| Object | Description |
|-------------------|---|
| • QCE# | Indicates the index of QCE. |
| • Port | Indicates the list of ports configured with the QCE. |
| • DMAC | Specify the type of Destination MAC addresses for incoming frame. Possible values are: <ul style="list-style-type: none"> ■ Any: All types of Destination MAC addresses are allowed. ■ Unicast: Only Unicast MAC addresses are allowed. ■ Multicast: Only Multicast MAC addresses are allowed. ■ Broadcast: Only Broadcast MAC addresses are allowed. The default value is 'Any'. |
| • SMAC | Displays the OUI field of Source MAC address, i.e. first three octet (byte) of MAC address. |
| • Tag Type | Indicates tag type. Possible values are: <ul style="list-style-type: none"> ■ Any: Match tagged and untagged frames. ■ Untagged: Match untagged frames. ■ Tagged: Match tagged frames. The default value is 'Any' |
| • VID | Indicates (VLAN ID), either a specific VID or range of VIDs. VID can be in the range 1-4095 or 'Any' |
| • PCP | Priority Code Point: Valid value PCP are specific(0, 1, 2, 3, 4, 5, 6, 7) or |

| | |
|-------------------------------|---|
| | range(0-1, 2-3, 4-5, 6-7, 0-3, 4-7) or 'Any'. |
| • DEI | Drop Eligible Indicator: Valid value of DEI can be any of values between 0, 1 or 'Any'. |
| • Frame Type | <p>Indicates the type of frame to look for incoming frames. Possible frame types are:</p> <ul style="list-style-type: none"> ■ Any: The QCE will match all frame type. ■ Ethernet: Only Ethernet frames (with Ether Type 0x600-0xFFFF) are allowed. ■ LLC: Only (LLC) frames are allowed. ■ SNAP: Only (SNAP) frames are allowed. ■ IPv4: The QCE will match only IPV4 frames. ■ IPv6: The QCE will match only IPV6 frames. |
| • Action | <p>Indicates the classification action taken on ingress frame if parameters configured are matched with the frame's content.</p> <p>There are three action fields: Class, DPL and DSCP.</p> <ul style="list-style-type: none"> ■ Class: Classified QoS class. ■ DPL: Classified Drop Precedence Level. ■ DSCP: Classified DSCP value. |
| • Modification Buttons | <p>You can modify each QCE in the table using the following buttons:</p> <ul style="list-style-type: none"> : Inserts a new QCE before the current row. : Edits the QCE. : Moves the QCE up the list. : Moves the QCE down the list. : Deletes the QCE. : The lowest plus sign adds a new entry at the bottom of the list of QCL. |

4.4.5.2 QoS Control Entry Configuration

The QCE Configuration screen in [Figure 4-4-5-2](#) appears.

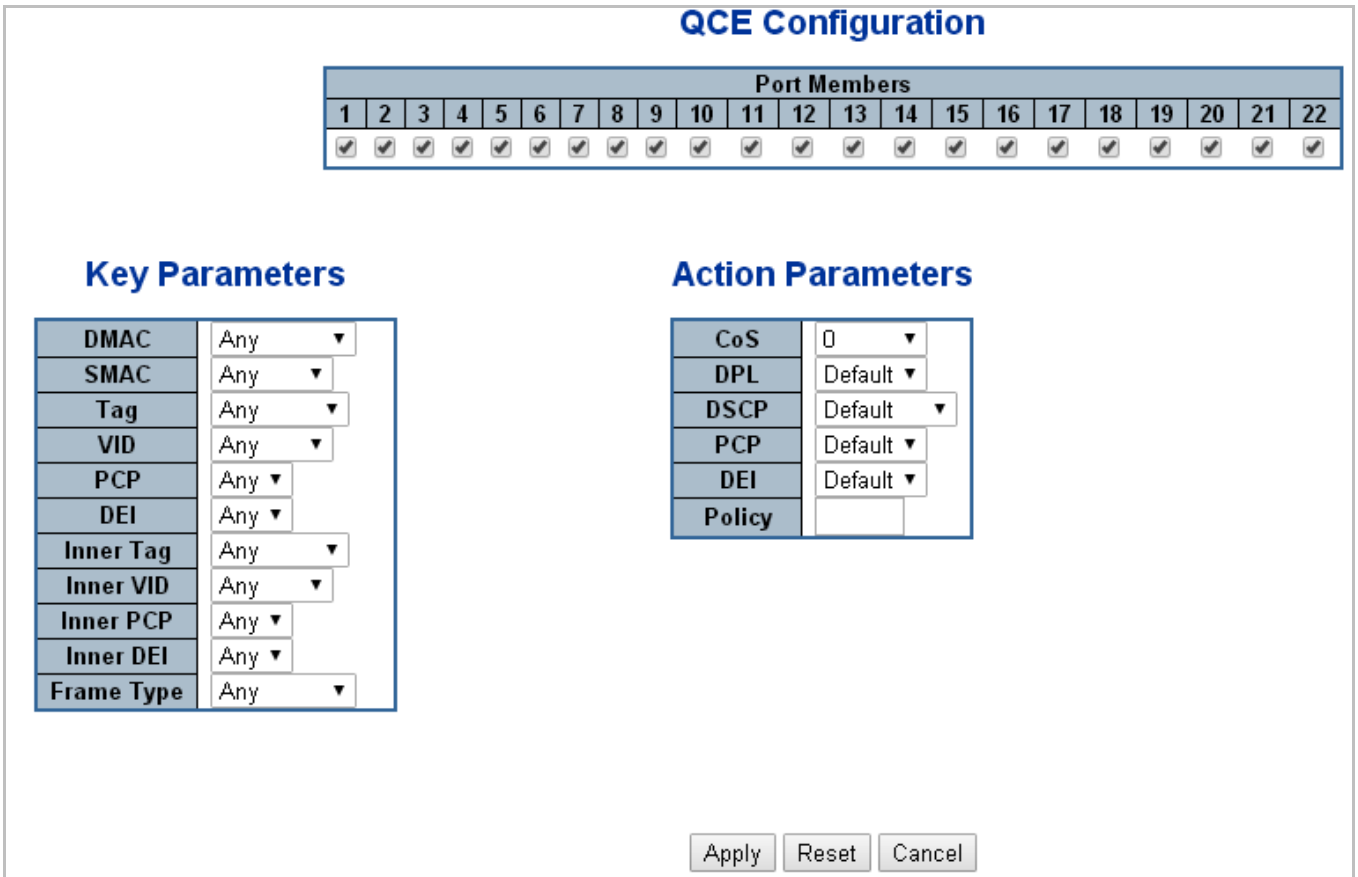

Figure 4-4-5-2: QCE Configuration Page Screenshot

The page includes the following fields:

| Object | Description |
|---|--|
| <ul style="list-style-type: none"> • Port Members | <p>Check the checkbox button in case you want to make any port member of the QCL entry. By default all ports will be checked</p> |
| <ul style="list-style-type: none"> • Key Parameters | <p>Key configuration are described as below:</p> <ul style="list-style-type: none"> ■ DMAC Type Destination MAC type: possible values are unicast(UC), multicast(MC), broadcast(BC) or 'Any' ■ SMAC Source MAC address: 24 MS bits (OUI) or 'Any' ■ Tag Value of Tag field can be 'Any', 'Untag' or 'Tag' ■ VID Valid value of VLAN ID can be any value in the range 1-4095 or 'Any'; user can enter either a specific value or a range of VIDs ■ PCP Priority Code Point: Valid value PCP are specific(0, 1, 2, 3, 4, 5, 6, 7) or range(0-1, 2-3, 4-5, 6-7, 0-3, 4-7) or 'Any' ■ DEI Drop Eligible Indicator: Valid value of DEI can be any of values between 0, 1 or 'Any' ■ Frame Type Frame Type can have any of the following values <ol style="list-style-type: none"> 1. Any 2. Ethernet |

| | |
|--------------------|---|
| | <p>3. LLC</p> <p>4. SNAP</p> <p>5. IPv4</p> <p>6. IPv6</p> <p>Note: all frame types are explained below.</p> |
| • Any | Allow all types of frames. |
| • EtherType | Ethernet Type Valid Ethernet type can have value within 0x600-0xFFFF or 'Any' but excluding 0x800(IPv4) and 0x86DD(IPv6), default value is 'Any'. |
| • LLC | <p>■ SSAP Address Valid SSAP(Source Service Access Point) can vary from 0x00 to 0xFF or 'Any', the default value is 'Any'</p> <p>■ DSAP Address Valid DSAP(Destination Service Access Point) can vary from 0x00 to 0xFF or 'Any', the default value is 'Any'</p> <p>■ Control Address Valid Control Address can vary from 0x00 to 0xFF or 'Any', the default value is 'Any'</p> |
| • SNAP | PID Valid PID(a.k.a Ethernet type) can have value within 0x00-0xFFFF or 'Any', default value is 'Any' |
| • IPv4 | <p>■ Protocol IP protocol number: (0-255, TCP or UDP) or 'Any'</p> <p>■ Source IP Specific Source IP address in value/mask format or 'Any'. IP and Mask are in the format x.y.z.w where x, y, z, and w are decimal numbers between 0 and 255. When Mask is converted to a 32-bit binary string and read from left to right, all bits following the first zero must also be zero</p> <p>DSCP Diffserv Code Point value(DSCP): It can be specific value, range of value or 'Any'. DSCP values are in the range 0-63 including BE, CS1-CS7, EF or AF11-AF43</p> <p>■ IP Fragment IPv4 frame fragmented option: yes no any</p> <p>■ Sport Source TCP/UDP port:(0-65535) or 'Any', specific or port range applicable for IP protocol UDP/TCP</p> <p>■ Dport Destination TCP/UDP port:(0-65535) or 'Any', specific or port range applicable for IP protocol UDP/TCP</p> |
| • IPv6 | <p>Protocol IP protocol number: (0-255, TCP or UDP) or 'Any'</p> <p>Source IP IPv6 source address: (a.b.c.d) or 'Any', 32 LS bits</p> <p>DSCP Diffserv Code Point value(DSCP): It can be specific value, range of value or 'Any'. DSCP values are in the range 0-63 including BE, CS1-CS7, EF or AF11-AF43</p> <p>Sport Source TCP/UDP port:(0-65535) or 'Any', specific or port range applicable for IP protocol UDP/TCP</p> <p>Dport Destination TCP/UDP port:(0-65535) or 'Any', specific or port range applicable for IP protocol UDP/TCP</p> |

| | |
|--|---|
| <ul style="list-style-type: none"> • Action Parameters | <p>Class QoS class: (0-7) or 'Default'.</p> <p>DPL Valid Drop Precedence Level can be (0-3) or 'Default'.</p> <p>DSCP Valid DSCP value can be (0-63, BE, CS1-CS7, EF or AF11-AF43) or 'Default'.</p> <p>'Default' means that the default classified value is not modified by this QCE.</p> |
|--|---|

Buttons

Apply : Click to apply changes

Reset : Click to undo any changes made locally and revert to previously saved values

Cancel : Return to the previous page without saving the configuration change

4.4.5.3 QCL Status

This page shows the QCL status by different QCL users. Each row describes the QCE that is defined. It is a conflict if a specific QCE is not applied to the hardware due to hardware limitations. The maximum number of QCEs is **256** on each switch. The QoS Control List Status screen in [Figure 4-4-5-3](#) appears.

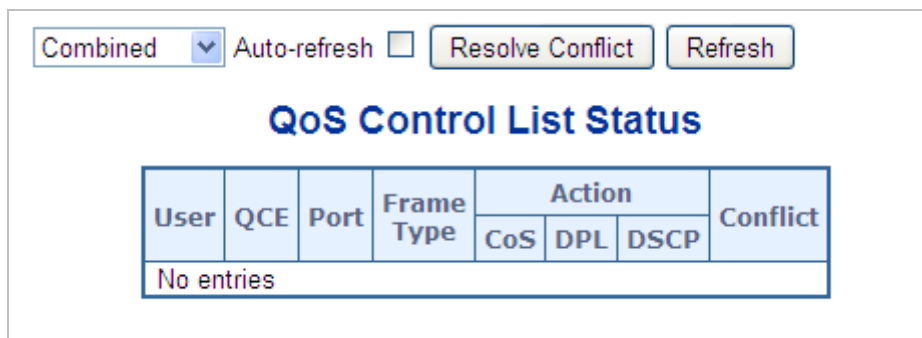

Figure 4-4-5-3: QoS Control List Status Page Screenshot

The page includes the following fields:

| Object | Description |
|---------------------|---|
| • User | Indicates the QCL user. |
| • QCE# | Indicates the index of QCE. |
| • Port | Indicates the list of ports configured with the QCE. |
| • Frame Type | Indicates the type of frame to look for incoming frames. Possible frame types are: <ul style="list-style-type: none"> ■ Any: The QCE will match all frame types. ■ Ethernet: Only Ethernet frames (with Ether Type 0x600-0xFFFF) are allowed. |

| | |
|---|--|
| | <ul style="list-style-type: none"> ■ LLC: Only (LLC) frames are allowed. ■ SNAP: Only (SNAP) frames are allowed. ■ IPv4: The QCE will match only IPV4 frames. ■ IPv6: The QCE will match only IPV6 frames. |
| <ul style="list-style-type: none"> • Action | <p>Indicates the classification action taken on ingress frame if parameters configured are matched with the frame's content.</p> <p>There are three action fields: Class, DPL and DSCP.</p> <ul style="list-style-type: none"> ■ Class: Classified QoS class; if a frame matches the QCE it will be put in the queue. ■ DPL: Drop Precedence Level; if a frame matches the QCE then DP level will set to value displayed under DPL column. ■ DSCP: If a frame matches the QCE then DSCP will be classified with the value displayed under DSCP column. |
| <ul style="list-style-type: none"> • Conflict | <p>Displays Conflict status of QCL entries. As H/W resources are shared by multiple applications. It may happen that resources required to add a QCE may not be available, in that case it shows conflict status as 'Yes', otherwise it is always 'No'.</p> <p>Please note that conflict can be resolved by releasing the H/W resources required to add QCL entry on pressing 'Resolve Conflict' button.</p> |

Buttons

: Select the QCL status from this drop down list.

Auto-refresh : Check this box to refresh the page automatically. Automatic refresh occurs every 3 seconds.

: Click to release the resources required to add QCL entry, in case the conflict status for any QCL entry is

'yes'.

: Click to refresh the page.

4.4.5.4 Voice VLAN Configuration

The Voice VLAN feature enables voice traffic forwarding on the Voice VLAN, then the switch can classify and schedule network traffic. It is recommended that there be two VLANs on a port - one for voice, one for data.

Before connecting the IP device to the switch, the IP phone should configure the voice VLAN ID correctly. It should be configured through its own GUI. The Voice VLAN Configuration screen in [Figure 4-4-5-4](#) appears.

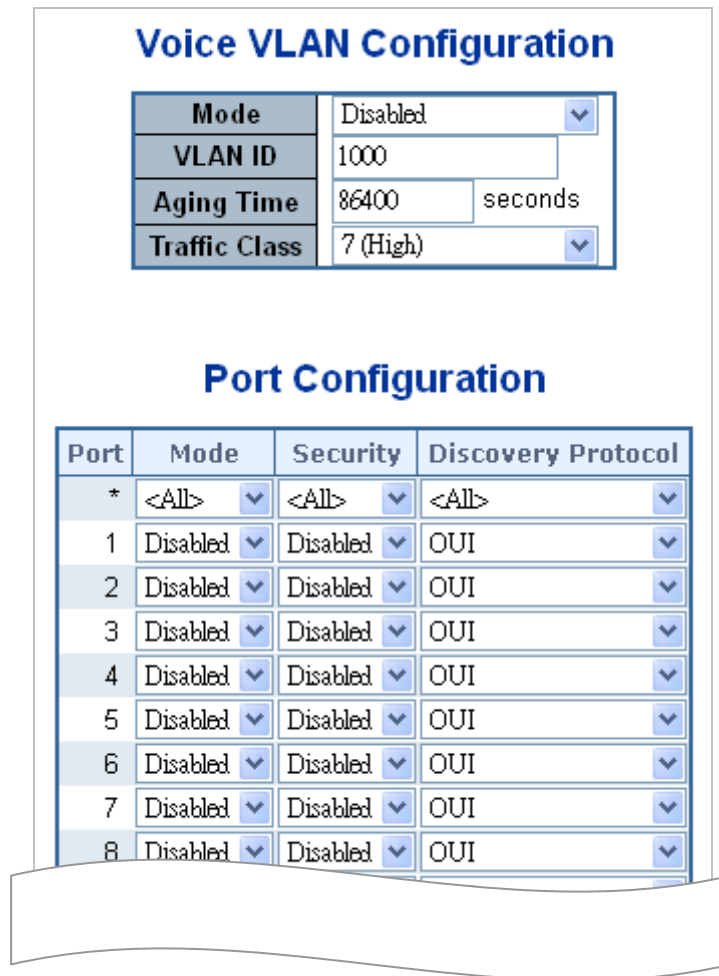

Figure 4-4-5-4: Voice VLAN Configuration Page Screenshot

The page includes the following fields:

| Object | Description |
|---|---|
| <ul style="list-style-type: none"> • Mode | <p>Indicates the Voice VLAN mode operation. We must disable MSTP feature before we enable Voice VLAN. It can avoid the conflict of ingress filter. Possible modes are:</p> <ul style="list-style-type: none"> ■ Enabled: Enable Voice VLAN mode operation. ■ Disabled: Disable Voice VLAN mode operation. |
| <ul style="list-style-type: none"> • VLAN ID | <p>Indicates the Voice VLAN ID. It should be a unique VLAN ID in the system and cannot equal each port PVID. It is conflict configuration if the value equal management VID, MVR VID, PVID etc.</p> <p>The allowed range is 1 to 4095.</p> |
| <ul style="list-style-type: none"> • Aging Time | <p>Indicates the Voice VLAN secure learning age time. The allowed range is 10 to 10000000 seconds. It used when security mode or auto detect mode is enabled. In other cases, it will based hardware age time.</p> |

| | |
|----------------------------------|--|
| | The actual age time will be situated in the [age_time; 2 * age_time] interval. |
| • Traffic Class | Indicates the Voice VLAN traffic class. All traffic on Voice VLAN will apply this class. |
| • Mode | <p>Indicates the Voice VLAN port mode.</p> <p>Possible port modes are:</p> <ul style="list-style-type: none"> ■ Disabled: Disjoin from Voice VLAN. ■ Auto: Enable auto detect mode. It detects whether there is VoIP phone attached to the specific port and configures the Voice VLAN members automatically. ■ Forced: Force join to Voice VLAN. |
| • Port Security | <p>Indicates the Voice VLAN port security mode. When the function is enabled, all non-telephone MAC address in Voice VLAN will be blocked 10 seconds. Possible port modes are:</p> <ul style="list-style-type: none"> ■ Enabled: Enable Voice VLAN security mode operation. ■ Disabled: Disable Voice VLAN security mode operation. |
| • Port Discovery Protocol | <p>Indicates the Voice VLAN port discovery protocol. It will only work when auto detect mode is enabled. We should enable LLDP feature before configuring discovery protocol to "LLDP" or "Both". Changing the discovery protocol to "OUI" or "LLDP" will restart auto detect process. Possible discovery protocols are:</p> <ul style="list-style-type: none"> ■ OUI: Detect telephony device by OUI address. ■ LLDP: Detect telephony device by LLDP. ■ Both: Both OUI and LLDP. |

4.4.5.5 Voice VLAN OUI Table

Configure VOICE VLAN OUI table on this page. The maximum entry number is 16. Modifying the OUI table will restart auto detection of OUI process. The Voice VLAN OUI Table screen in [Figure 4-4-5-5](#) appears.

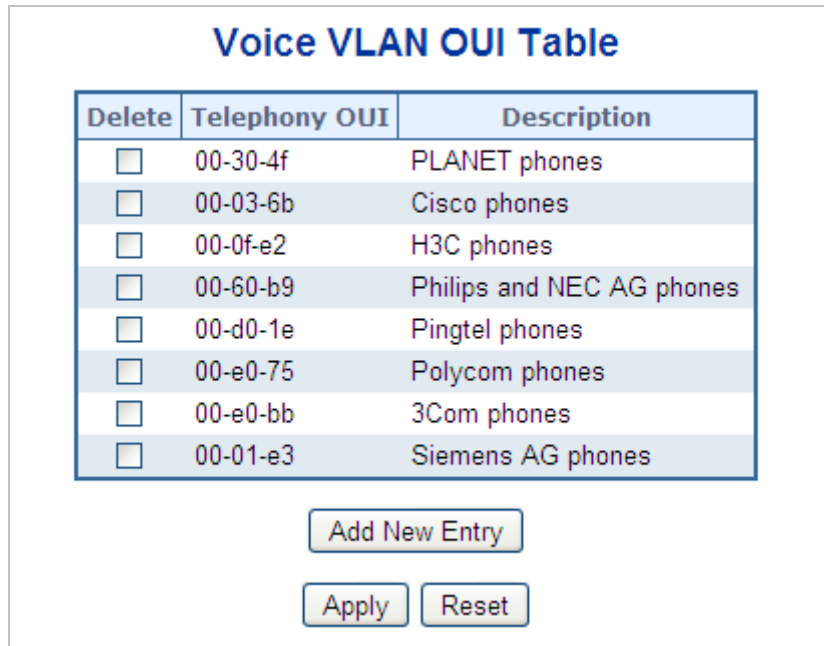

Figure 4-4-5-5: Voice VLAN OUI Table Page Screenshot

The page includes the following fields:

| Object | Description |
|--|--|
| <ul style="list-style-type: none"> Delete | Check to delete the entry. It will be deleted during the next save. |
| <ul style="list-style-type: none"> Telephony OUI | An telephony OUI address is a globally unique identifier assigned to a vendor by IEEE. It must be 6 characters long and the input format is "xx-xx-xx" (x is a hexadecimal digit). |
| <ul style="list-style-type: none"> Description | The description of OUI address. Normally, it describes which vendor telephony device it belongs to. The allowed string length is 0 to 32. |

Buttons

: Click to add a new access management entry.

: Click to apply changes

: Click to undo any changes made locally and revert to previously saved values.

4.5 Security

4.5.1 Access Security

4.5.1.1 Access Management

Configure access management table on this page. The maximum entry number is 16. If the application's type match any one of the access management entries, it will allow access to the switch. The Access Management Configuration screen in [Figure 4-5-1-1](#) appears.

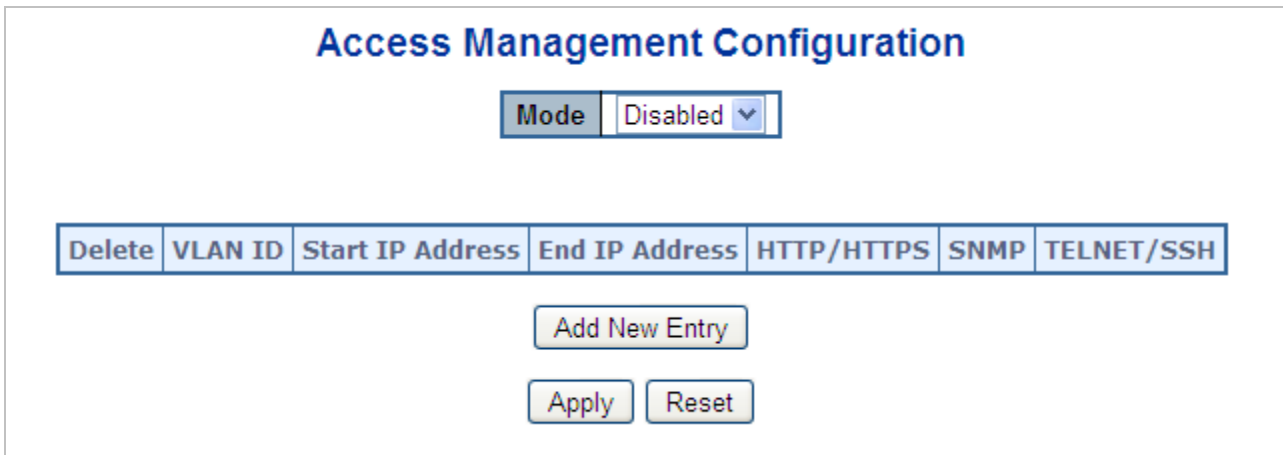

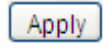
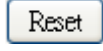

Figure 4-5-1-1: Access Management Configuration Overview Page Screenshot

The page includes the following fields:

| Object | Description |
|---|---|
| <ul style="list-style-type: none"> • Mode | Indicates the access management mode operation. Possible modes are: Enabled: Enable access management mode operation. Disabled: Disable access management mode operation. |
| <ul style="list-style-type: none"> • Delete | Check to delete the entry. It will be deleted during the next apply . |
| <ul style="list-style-type: none"> • VLAN ID | Indicates the VLAN ID for the access management entry. |
| <ul style="list-style-type: none"> • Start IP address | Indicates the start IP address for the access management entry. |
| <ul style="list-style-type: none"> • End IP address | Indicates the end IP address for the access management entry. |
| <ul style="list-style-type: none"> • HTTP/HTTPS | Indicates the host can access the switch from HTTP/HTTPS interface that the host IP address matched the entry. |
| <ul style="list-style-type: none"> • SNMP | Indicates the host can access the switch from SNMP interface that the host IP address matched the entry. |
| <ul style="list-style-type: none"> • Telnet/SSH | Indicates the host can access the switch from TELNET/SSH interface that the host IP address matched the entry. |

Buttons

-  : Click to add a new access management entry.
-  : Click to apply changes
-  : Click to undo any changes made locally and revert to previously saved values.

4.5.1.2 Access Management Statistics

This page provides statistics for access management. The Access Management Statistics screen in [Figure 4-5-1-2](#) appears.

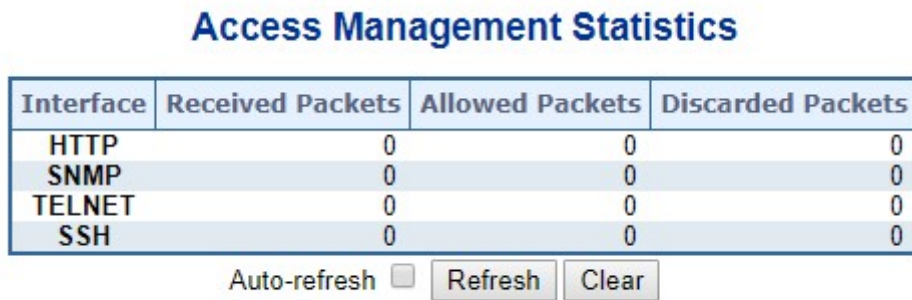
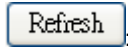
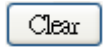

Figure 4-5-1-2: Access Management Statistics Overview Page Screenshot

The page includes the following fields:

| Object | Description |
|--------------------------|--|
| • Interface | The interface that allowed remote host can access the switch. |
| • Receive Packets | The received packets number from the interface under access management mode is enabled. |
| • Allow Packets | The allowed packets number from the interface under access management mode is enabled. |
| • Discard Packets | The discarded packets number from the interface under access management mode is enabled. |

Buttons

- Auto-refresh Check this box to refresh the page automatically. Automatic refresh occurs every 3 seconds.
-  : Click to refresh the page immediately.
-  : Clears all statistics.

4.5.1.3 SSH

Configure SSH on this page. This page shows the Port Security status. Port Security is a module with no direct configuration. Configuration comes indirectly from other modules - the user modules. When a user module has enabled port security on a port, the port is set-up for software-based learning. In this mode, frames from unknown MAC addresses are passed on to the port security module, which in turn asks all user modules whether to allow this new MAC address to forward or block it. For a MAC address to be set in the forwarding state, all enabled user modules must unanimously agree on allowing the MAC address to forward. If only one chooses to block it, it will be blocked until that user module decides otherwise.

The status page is divided into two sections - one with a legend of user modules and one with the actual port status. The SSH Configuration screen in [Figure 4-5-1-3](#) appears.

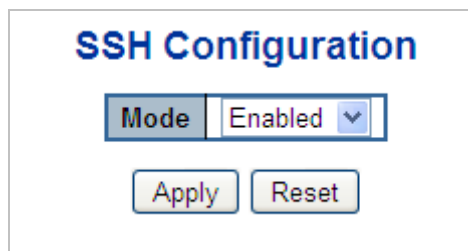



Figure 4-5-1-3: SSH Configuration Screen Page Screenshot

The page includes the following fields:

| Object | Description |
|---|--|
| <ul style="list-style-type: none"> • Mode | Indicates the SSH mode operation. Possible modes are: <ul style="list-style-type: none"> ■ Enabled: Enable SSH mode operation. ■ Disabled: Disable SSH mode operation. |

Buttons

 : Click to apply changes

 : Click to undo any changes made locally and revert to previously saved values.

4.5.1.4 HTTPS

Configure HTTPS on this page. The HTTPS Configuration screen in [Figure 4-5-1-4](#) appears.

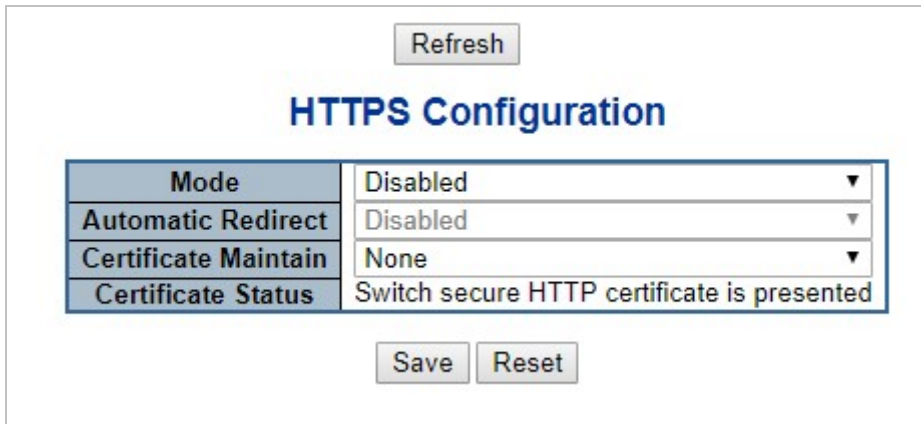

Figure 4-5-1-4: HTTPS Configuration Screen Page Screenshot

The page includes the following fields:

| Object | Description |
|---|---|
| <ul style="list-style-type: none"> • Mode | <p>Indicates the HTTPS mode operation. When the current connection is HTTPS, to apply HTTPS disabled mode operation will automatically redirect web browser to an HTTP connection. Possible modes are:</p> <ul style="list-style-type: none"> ■ Enabled: Enable HTTPS mode operation. ■ Disabled: Disable HTTPS mode operation. |
| <ul style="list-style-type: none"> • Automatic Redirect | <p>Indicates the HTTPS redirect mode operation. It only significant if HTTPS mode "Enabled" is selected. Automatically redirects web browser to an HTTPS connection when both HTTPS mode and Automatic Redirect are enabled or redirects web browser to an HTTP connection when both are disabled. Possible modes are:</p> <ul style="list-style-type: none"> ■ Enabled: Enable HTTPS redirect mode operation. ■ Disabled: Disable HTTPS redirect mode operation. |
| <ul style="list-style-type: none"> • Certificate Maintain | <p>The operation of certificate maintenance.</p> <p>Possible operations are:</p> <p>None: No operation.</p> <p>Delete: Delete the current certificate.</p> <p>Upload: Upload a certificate PEM file. Possible methods are: Web Browser or URL.</p> <p>Generate: Generate a new self-signed RSA certificate.</p> |

| | |
|--|---|
| <ul style="list-style-type: none"> • Certificate Pass Phrase | <p>Enter the pass phrase in this field if your uploading certificate is protected by a specific passphrase.</p> |
| <ul style="list-style-type: none"> • Certificate Upload | <p>Upload a certificate PEM file into the switch. The file should contain the certificate and private key together. If you have two separated files for saving certificate and private key. Use the Linux cat command to combine them into a single PEM file. For example, <code>cat my.cert my.key > my.pem</code></p> <p>Notice that the RSA certificate is recommended since most of the new version of browsers has removed support for DSA in certificate, e.g. Firefox v37 and Chrome v39.</p> <p>Possible methods are:</p> <p>Web Browser: Upload a certificate via Web browser.</p> <p>URL: Upload a certificate via URL, the supported protocols are HTTP, HTTPS, TFTP and FTP. The URL format is <code><protocol>://[<username>[:<password>]@]<host>[:<port>][/<path>]/<file_name></code>. For example, <code>tftp://10.10.10.10/new_image_path/new_image.dat</code>, <code>http://username:password@10.10.10.10:80/new_image_path/new_image.dat</code>. A valid file name is a text string drawn from alphabet (A-Za-z), digits (0-9), dot (.), hyphen (-), under score(_). The maximum length is 63 and hyphen must not be first character. The file name content that only contains '.' is not allowed.</p> |
| <ul style="list-style-type: none"> • Certificate Status | <p>Display the current status of certificate on the switch.</p> <p>Possible statuses are:</p> <p><code>Switch secure HTTP certificate is presented.</code></p> <p><code>Switch secure HTTP certificate is not presented.</code></p> <p><code>Switch secure HTTP certificate is generating ...</code></p> |

Buttons

Save : Click to save changes.

Reset : Click to undo any changes made locally and revert to previously saved values.

Refresh : Click to refresh the page. Any changes made locally will be undone.

4.5.2 AAA

This section is to control the access to the **Industrial Managed Switch**, including the user access and management control.

The Authentication section contains links to the following main topics:

- **User Authentication**
- **IEEE 802.1X Port-based Network Access Control**
- **MAC-based Authentication**

Overview of 802.1X (Port-Based) Authentication

In the 802.1X-world, the user is called the supplicant, the switch is the authenticator, and the RADIUS server is the authentication server. The switch acts as the man-in-the-middle, forwarding requests and responses between the supplicant and the authentication server. Frames sent between the supplicant and the switch are special 802.1X frames, known as **EAPOL (EAP Over LANs)** frames. EAPOL frames encapsulate **EAP PDUs** (RFC3748). Frames sent between the switch and the RADIUS server are RADIUS packets. RADIUS packets also encapsulate EAP PDUs together with other attributes like the switch's IP address, name, and the supplicant's port number on the switch. EAP is very flexible, in that it allows for different authentication methods, like **MD5-Challenge**, **PEAP**, and **TLS**. The important thing is that the authenticator (the switch) doesn't need to know which authentication method the supplicant and the authentication server are using, or how many information exchange frames are needed for a particular method. The switch simply encapsulates the EAP part of the frame into the relevant type (EAPOL or RADIUS) and forwards it.

When authentication is complete, the RADIUS server sends a special packet containing a success or failure indication. Besides forwarding this decision to the supplicant, the switch uses it to open up or block traffic on the switch port connected to the supplicant.

Overview of MAC-based Authentication

Unlike 802.1X, MAC-based authentication is not a standard, but merely a best-practices method adopted by the industry. In MAC-based authentication, users are called clients, and the switch acts as the supplicant on behalf of clients. The initial frame (any kind of frame) sent by a client is snooped by the switch, which in turn uses the client's MAC address as both username and password in the subsequent EAP exchange with the RADIUS server. The 6-byte MAC address is converted to a string on the following form "xx-xx-xx-xx-xx-xx", that is, a dash (-) is used as separator between the lower-cased hexadecimal digits. The switch only supports the MD5-Challenge authentication method, so the RADIUS server must be configured accordingly.

When authentication is complete, the RADIUS server sends a success or failure indication, which in turn causes the switch to open up or block traffic for that particular client, using static entries into the MAC Table. Only then will frames from the client be forwarded on the switch. There are no EAPOL frames involved in this authentication, and therefore, MAC-based Authentication has nothing to do with the 802.1X standard.

The advantage of MAC-based authentication over 802.1X is that several clients can be connected to the same port (e.g. through a 3rd party switch or a hub) and still require individual authentication, and that the clients don't need special supplicant software

to authenticate. The disadvantage is that MAC addresses can be spoofed by malicious users, equipment whose MAC address is a valid RADIUS user can be used by anyone, and only the MD5-Challenge method is supported.

The 802.1X and MAC-Based Authentication configuration consists of two sections, a system- and a port-wide.

Overview of User Authentication

It is allowed to configure the **Industrial Managed Switch** to authenticate users logging into the system for management access using local or remote authentication methods, such as telnet and Web browser. This **Industrial Managed Switch** provides secure network management access using the following options:

- **Remote Authentication Dial-in User Service (RADIUS)**
- **Terminal Access Controller Access Control System Plus (TACACS+)**
- **Local user name and Privilege Level control**

RADIUS and TACACS+ are logon authentication protocols that use software running on a central server to control access to RADIUS-aware or TACACS-aware devices on the network. An **authentication server** contains a database of multiple user name / password pairs with associated privilege levels for each user that requires management access to the **Industrial Managed Switch**.

Understanding IEEE 802.1X Port-based Authentication

The IEEE 802.1X standard defines a client-server-based access control and authentication protocol that restricts unauthorized clients from connecting to a LAN through publicly accessible ports. The authentication server authenticates each client connected to a switch port before making available any services offered by the switch or the LAN.

Until the client is authenticated, 802.1X access control allows only **Extensible Authentication Protocol over LAN (EAPOL)** traffic through the port to which the client is connected. After authentication is successful, normal traffic can pass through the port.

This section includes this conceptual information:

- Device Roles
- Authentication Initiation and Message Exchange
- Ports in Authorized and Unauthorized States

■ **Device Roles**

With 802.1X port-based authentication, the devices in the network have specific roles as shown below.

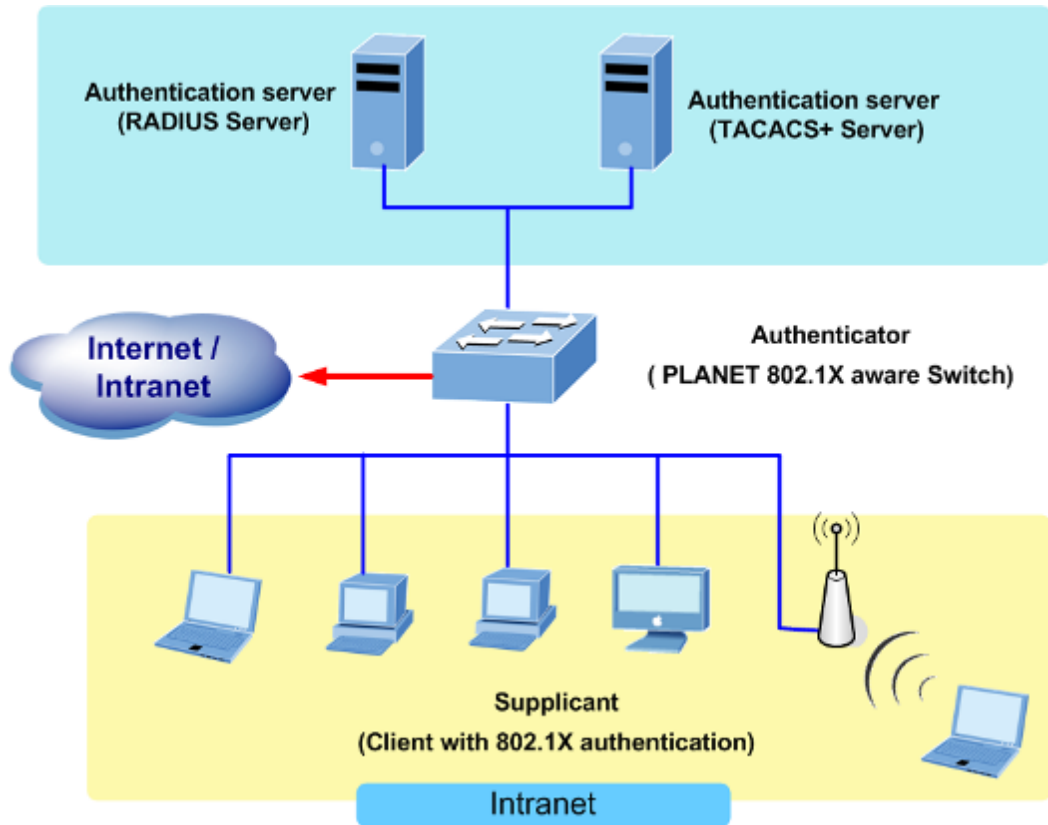

Figure 4-5-2-1

- **Client**—the device (workstation) that requests access to the LAN and switch services and responds to requests from the switch. The workstation must be running 802.1X-compliant client software such as that offered in the Microsoft Windows XP operating system. (The client is the *supplicant* in the IEEE 802.1X specification.)
- **Authentication server**—performs the actual authentication of the client. The authentication server validates the identity of the client and notifies the switch whether or not the client is authorized to access the LAN and switch services. Because the switch acts as the proxy, the authentication service is transparent to the client. In this release, the Remote Authentication Dial-In User Service (RADIUS) security system with **Extensible Authentication Protocol (EAP)** extensions is the only supported authentication server; it is available in Cisco Secure Access Control Server version 3.0. RADIUS operates in a client/server model in which secure authentication information is exchanged between the RADIUS server and one or more RADIUS clients.
- **Switch (802.1X device)**—controls the physical access to the network based on the authentication status of the client. The switch acts as an intermediary (proxy) between the client and the authentication server, requesting identity information from the client, verifying that information with the authentication server, and relaying a response to the client. The switch includes the RADIUS client, which is responsible for encapsulating and decapsulating the Extensible Authentication Protocol (EAP) frames and interacting with the authentication server. When the switch receives EAPOL frames and relays them to the authentication server, the Ethernet header is stripped and the remaining EAP frame is re-encapsulated in the RADIUS format. The EAP frames are not modified or examined during encapsulation, and the authentication server must support EAP within the native frame format. When the switch receives frames from the

authentication server, the server's frame header is removed, leaving the EAP frame, which is then encapsulated for Ethernet and sent to the client.

■ Authentication Initiation and Message Exchange

The switch or the client can initiate authentication. If you enable authentication on a port by using the **dot1x port-control auto** interface configuration command, the switch must initiate authentication when it determines that the port link state transitions from down to up. It then sends an EAP-request/identity frame to the client to request its identity (typically, the switch sends an initial identity/request frame followed by one or more requests for authentication information). Upon receipt of the frame, the client responds with an EAP-response/identity frame.

However, if during bootup, the client does not receive an EAP-request/identity frame from the switch, the client can initiate authentication by sending an EAPOL-start frame, which prompts the switch to request the client's identity



If 802.1X is not enabled or supported on the network access device, any EAPOL frames from the client are dropped. If the client does not receive an EAP-request/identity frame after three attempts to start authentication, the client transmits frames as if the port is in the authorized state. A port in the authorized state effectively means that the client has been successfully authenticated.

When the client supplies its identity, the switch begins its role as the intermediary, passing EAP frames between the client and the authentication server until authentication succeeds or fails. If the authentication succeeds, the switch port becomes authorized.

The specific exchange of EAP frames depends on the authentication method being used. "Figure 4-5-2" shows a message exchange initiated by the client using the One-Time-Password (OTP) authentication method with a RADIUS server.

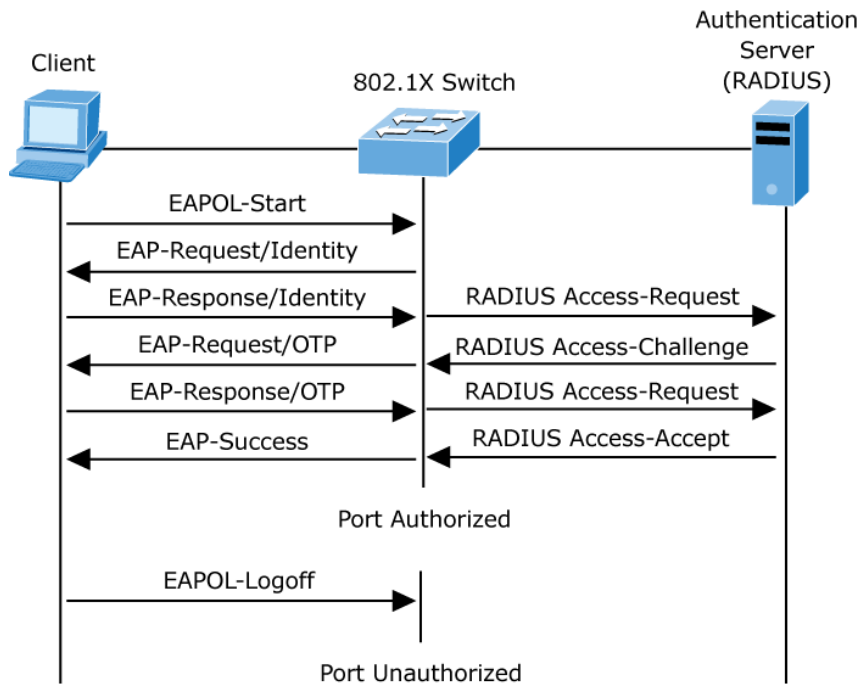

Figure 4-5-2-2: EAP Message Exchange

■ Ports in Authorized and Unauthorized States

The switch port state determines whether or not the client is granted access to the network. The port starts in the *unauthorized* state. While in this state, the port disallows all ingress and egress traffic except for 802.1X protocol packets. When a client is successfully authenticated, the port transitions to the *authorized* state, allowing all traffic for the client to flow normally.

If a client that does not support 802.1X is connected to an unauthorized 802.1X port, the switch requests the client's identity. In this situation, the client does not respond to the request, the port remains in the unauthorized state, and the client is not granted access to the network.

In contrast, when an 802.1X-enabled client connects to a port that is not running the 802.1X protocol, the client initiates the authentication process by sending the EAPOL-start frame. When no response is received, the client sends the request for a fixed number of times. Because no response is received, the client begins sending frames as if the port is in the authorized state

If the client is successfully authenticated (receives an Accept frame from the authentication server), the port state changes to authorized, and all frames from the authenticated client are allowed through the port. If the authentication fails, the port remains in the unauthorized state, but authentication can be retried. If the authentication server cannot be reached, the switch can retransmit the request. If no response is received from the server after the specified number of attempts, authentication fails, and network access is not granted.

When a client logs off, it sends an EAPOL-logoff message, causing the switch port to transition to the unauthorized state.

If the link state of a port transitions from up to down, or if an EAPOL-logoff frame is received, the port returns to the unauthorized state.

4.5.2.1 Authentication Configuration

This page allows you to configure how a user is authenticated when he logs into the switch via one of the management client interfaces. The Authentication Method Configuration screen in [Figure 4-5-2-3](#) appears.

Authentication Method Configuration

| Client | Methods | | |
|---------|---------|------|------|
| console | local ▼ | no ▼ | no ▼ |
| telnet | local ▼ | no ▼ | no ▼ |
| ssh | local ▼ | no ▼ | no ▼ |
| http | local ▼ | no ▼ | no ▼ |

Command Authorization Method Configuration

| Client | Method | Cmd Lvl | Cfg Cmd |
|---------|--------|---------|--------------------------|
| console | no ▼ | 0 | <input type="checkbox"/> |
| telnet | no ▼ | 0 | <input type="checkbox"/> |
| ssh | no ▼ | 0 | <input type="checkbox"/> |

Accounting Method Configuration

| Client | Method | Cmd Lvl | Exec |
|---------|--------|---------|--------------------------|
| console | no ▼ | | <input type="checkbox"/> |
| telnet | no ▼ | | <input type="checkbox"/> |
| ssh | no ▼ | | <input type="checkbox"/> |

Figure 4-5-2-3: Authentication Method Configuration Page Screenshot

The page includes the following fields:

Authentication Method Configuration

The authentication section allows you to configure how a user is authenticated when he logs into the switch via one of the management client interfaces.

The table has one row for each client type and a number of columns, which are:

| Object | Description |
|--------|-------------|
|--------|-------------|

| | |
|-----------|---|
| • Client | The management client for which the configuration below applies. |
| • Methods | Method can be set to one of the following values: <ul style="list-style-type: none"> no: Authentication is disabled and login is not possible. local: Use the local user database on the switch for authentication. radius: Use remote RADIUS server(s) for authentication. tacacs: Use remote TACACS+ server(s) for authentication.. |

Command Authorization Method Configuration

The command authorization section allows you to limit the CLI commands available to a user.

The table has one row for each client type and a number of columns, which are:

| Object | Description |
|-----------|---|
| • Client | The management client for which the configuration below applies. |
| • Methods | Method can be set to one of the following values: <ul style="list-style-type: none"> no: Command authorization is disabled. User is granted access to CLI commands according to his privilege level. tacacs: Use remote TACACS+ server(s) for command authorization. If all remote servers are offline, the user is granted access to CLI commands according to his privilege level |
| • Cmd Lvl | Authorize all commands with a privilege level higher than or equal to this level. Valid values are in the range 0 to 15. |
| • Cfg Cmd | Also authorize configuration commands |

Accounting Method Configuration

The accounting section allows you to configure command and exec (login) accounting.

The table has one row for each client type and a number of columns, which are:

| Object | Description |
|-----------|--|
| • Client | The management client for which the configuration below applies. |
| • Methods | Method can be set to one of the following values: |

| | |
|------------------|--|
| | <ul style="list-style-type: none"> no: Accounting is disabled. tacacs: Use remote TACACS+ server(s) for accounting. |
| • Cmd Lvl | <p>Enable accounting of all commands with a privilege level higher than or equal to this level.</p> <p>Valid values are in the range 0 to 15. Leave the field empty to disable command accounting.</p> |
| • Exec | <p>Enable exec (login) accounting.</p> |

Buttons

Apply : Click to apply changes

Reset : Click to undo any changes made locally and revert to previously saved values.

4.5.2.2 RADIUS

This page allows you to configure the RADIUS Servers. The RADIUS Configuration screen in [Figure 4-5-2-4](#) appears.

RADIUS Server Configuration

Global Configuration

| | | |
|--------------------------|----------------------|---------|
| Timeout | 5 | seconds |
| Retransmit | 3 | times |
| Deadtime | 0 | minutes |
| Change Secret Key | No ▾ | |
| NAS-IP-Address | <input type="text"/> | |
| NAS-IPv6-Address | <input type="text"/> | |
| NAS-Identifier | <input type="text"/> | |

Server Configuration

| | | | | | | |
|---------------|-------------------|------------------|------------------|----------------|-------------------|--------------------------|
| Delete | IP Address | Auth Port | Acct Port | Timeout | Retransmit | Change Secret Key |
|---------------|-------------------|------------------|------------------|----------------|-------------------|--------------------------|

Figure 4-5-2-4: RADIUS Server Configuration Page Screenshot

The page includes the following fields:

Global Configuration

These setting are common for all of the RADIUS Servers.

| Object | Description |
|---|--|
| <ul style="list-style-type: none"> Timeout | Timeout is the number of seconds, in the range 1 to 1000, to wait for a reply from a RADIUS server before retransmitting the request. |
| <ul style="list-style-type: none"> Retransmit | Retransmit is the number of times, in the range from 1 to 1000; a RADIUS request is retransmitted to a server that is not responding. If the server has not responded after the last retransmit, it is considered to be dead. |
| <ul style="list-style-type: none"> Dead Time | The Dead Time, which can be set to a number between 0 and 3600 seconds, is the period during which the switch will not send new requests to a server that has failed to respond to a previous request. This will stop the switch from continually trying to contact a server that it has already determined as dead. Setting the Dead Time to a value greater than 0 (zero) will enable this feature, but only if more than one server has been configured. |
| <ul style="list-style-type: none"> Key | The secret key - up to 63 characters long - shared between the RADIUS server and the switch. |
| <ul style="list-style-type: none"> NAS-IP-Address | The IPv4 address to be used as attribute 4 in RADIUS Access-Request packets. If this field is left blank, the IP address of the outgoing interface is used. |
| <ul style="list-style-type: none"> NAS-IPv6-Address | The IPv6 address to be used as attribute 95 in RADIUS Access-Request packets. If this field is left blank, the IP address of the outgoing interface is used. |
| <ul style="list-style-type: none"> NAS-Identifier | The identifier - up to 253 characters long - to be used as attribute 32 in RADIUS Access-Request packets. If this field is left blank, the NAS-Identifier is not included in the packet. |

Server Configuration

The table has one row for each RADIUS Server and a number of columns, which are:

| Object | Description |
|--|--|
| <ul style="list-style-type: none"> Delete | To delete a RADIUS server entry, check this box. The entry will be deleted during the next Save. |
| <ul style="list-style-type: none"> Hostname | The IP address or hostname of the RADIUS server. |
| <ul style="list-style-type: none"> Auth Port | The UDP port to use on the RADIUS server for authentication. |

| | |
|---------------------|---|
| • Acct Port | The UDP port to use on the RADIUS server for accounting. |
| • Timeout | This optional setting overrides the global timeout value. Leaving it blank will use the global timeout value. |
| • Retransmit | This optional setting overrides the global retransmit value. Leaving it blank will use the global retransmit value. |
| • Key | This optional setting overrides the global key. Leaving it blank will use the global key. |

Buttons

Add New Server : Click to add a new RADIUS server. An empty row is added to the table, and the RADIUS server can be configured as needed. Up to 5 servers are supported.

Delete : Click to undo the addition of the new server.

Apply : Click to apply changes

Reset : Click to undo any changes made locally and revert to previously saved values.

4.5.2.3 TACACS+

This page allows you to configure the TACACS+ Servers. The TACACS+ Configuration screen in [Figure 4-5-2-5](#) appears.

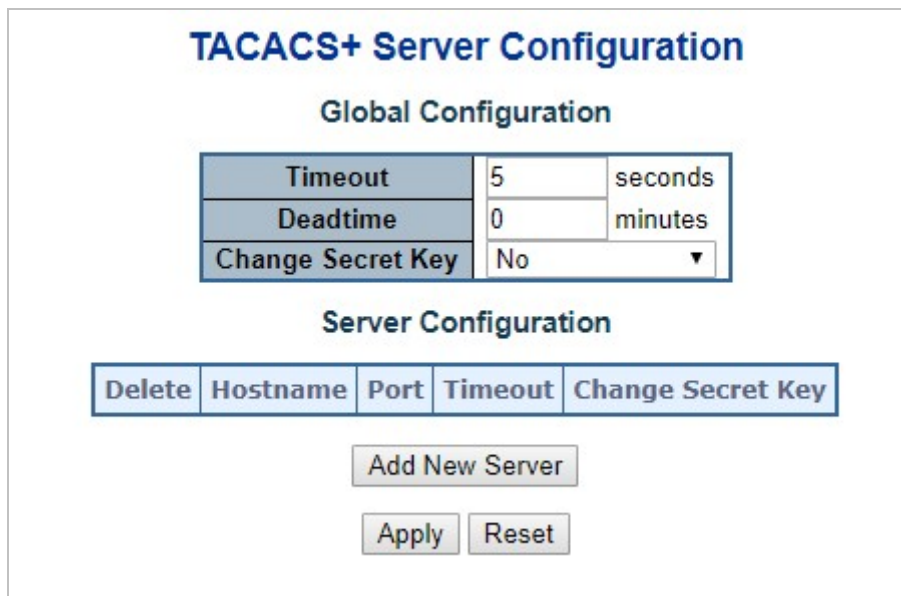

Figure 4-5-2-5: TACACS+ Server Configuration Page Screenshot

The page includes the following fields:

Global Configuration

These settings are common for all of the TACACS+ Servers.

| Object | Description |
|--|--|
| <ul style="list-style-type: none"> Timeout | Timeout is the number of seconds, in the range 1 to 1000, to wait for a reply from a TACACS+ server before it is considered to be dead. |
| <ul style="list-style-type: none"> Dead Time | <p>The Dead Time, which can be set to a number between 0 to 1440 minutes, is the period during which the switch will not send new requests to a server that has failed to respond to a previous request. This will stop the switch from continually trying to contact a server that it has already determined as dead.</p> <p>Setting the Dead Time to a value greater than 0 (zero) will enable this feature, but only if more than one server has been configured.</p> |
| <ul style="list-style-type: none"> Key | Specify to change the secret key or not. When "Yes" is selected for the option, you can change the secret key - up to 63 characters long - shared between the TACACS+ server and the switch. |

Server Configuration

The table has one row for each TACACS+ server and a number of columns, which are:

| Object | Description |
|---|---|
| <ul style="list-style-type: none"> Delete | To delete a TACACS+ server entry, check this box. The entry will be deleted during the next Save. |
| <ul style="list-style-type: none"> Hostname | The IP address or hostname of the TACACS+ server. |
| <ul style="list-style-type: none"> Port | The TCP port to use on the TACACS+ server for authentication. |
| <ul style="list-style-type: none"> Timeout | This optional setting overrides the global timeout value. Leaving it blank will use the global timeout value. |
| <ul style="list-style-type: none"> Key | This optional setting overrides the global key. Leaving it blank will use the global key. |

Buttons

Add New Server: Click to add a new TACACS+ server. An empty row is added to the table, and the TACACS+ server can be configured as needed. Up to 5 servers are supported.

Delete: Click to undo the addition of the new server.

Apply: Click to apply changes

Reset: Click to undo any changes made locally and revert to previously saved values.

4.5.2.4 RADIUS Overview

This page provides an overview of the status of the RADIUS servers configurable on the authentication configuration page. The RADIUS Authentication/Accounting Server Overview screen in [Figure 4-5-2-6](#) appears.

| RADIUS Server Status Overview | | | | | |
|-------------------------------|------------|---------------------|-----------------------|-----------------|-------------------|
| # | IP Address | Authentication Port | Authentication Status | Accounting Port | Accounting Status |
| 1 | | | Disabled | | Disabled |
| 2 | | | Disabled | | Disabled |
| 3 | | | Disabled | | Disabled |
| 4 | | | Disabled | | Disabled |
| 5 | | | Disabled | | Disabled |

Auto-refresh Refresh

Figure 4-5-2-6: RADIUS Authentication/Accounting Server Overview Page Screenshot

The page includes the following fields:

RADIUS Authentication Server Status Overview

| Object | Description |
|-------------------------|--|
| • # | The RADIUS server number. Click to navigate to detailed statistics for this server. |
| • IP Address | The IP address and UDP port number (in <IP Address>:<UDP Port> notation) of this server. |
| • Authentication Port | UDP port number for authentication. |
| • Authentication Status | The current status of the server. This field takes one of the following values: Disabled : The server is disabled. Not Ready : The server is enabled, but IP communication is not yet up and running. Ready : The server is enabled, IP communication is up and running, and the RADIUS module is ready to accept access attempts. Dead (X seconds left) : Access attempts were made to this server, but it did not reply within the configured timeout. The server has temporarily been disabled, but will get re-enabled when the dead-time expires. The number of seconds left before this occurs is displayed in parentheses. This state is only reachable when more than one server is enabled. |
| • Accounting Port | UDP port number for accounting |
| • Accounting Status | The current status of the server. This field takes one of the following values: Disabled : The server is disabled. |

| |
|--|
| <p>Not Ready: The server is enabled, but IP communication is not yet up and running.</p> <p>Ready: The server is enabled, IP communication is up and running, and the RADIUS module is ready to accept access attempts.</p> <p>Dead (X seconds left): Access attempts were made to this server, but it did not reply within the configured timeout. The server has temporarily been disabled, but will get re-enabled when the dead-time expires. The number of seconds left before this occurs is displayed in parentheses. This state is only reachable when more than one server is enabled.</p> |
|--|

Buttons

Auto-refresh : Check this box to refresh the page automatically. Automatic refresh occurs every 3 seconds.

: Click to refresh the page immediately.

4.5.2.5 RADIUS Details

This page provides detailed statistics for a particular RADIUS server. The RADIUS Authentication/Accounting for Server Overview screen in [Figure 4-5-2-7](#) appears.

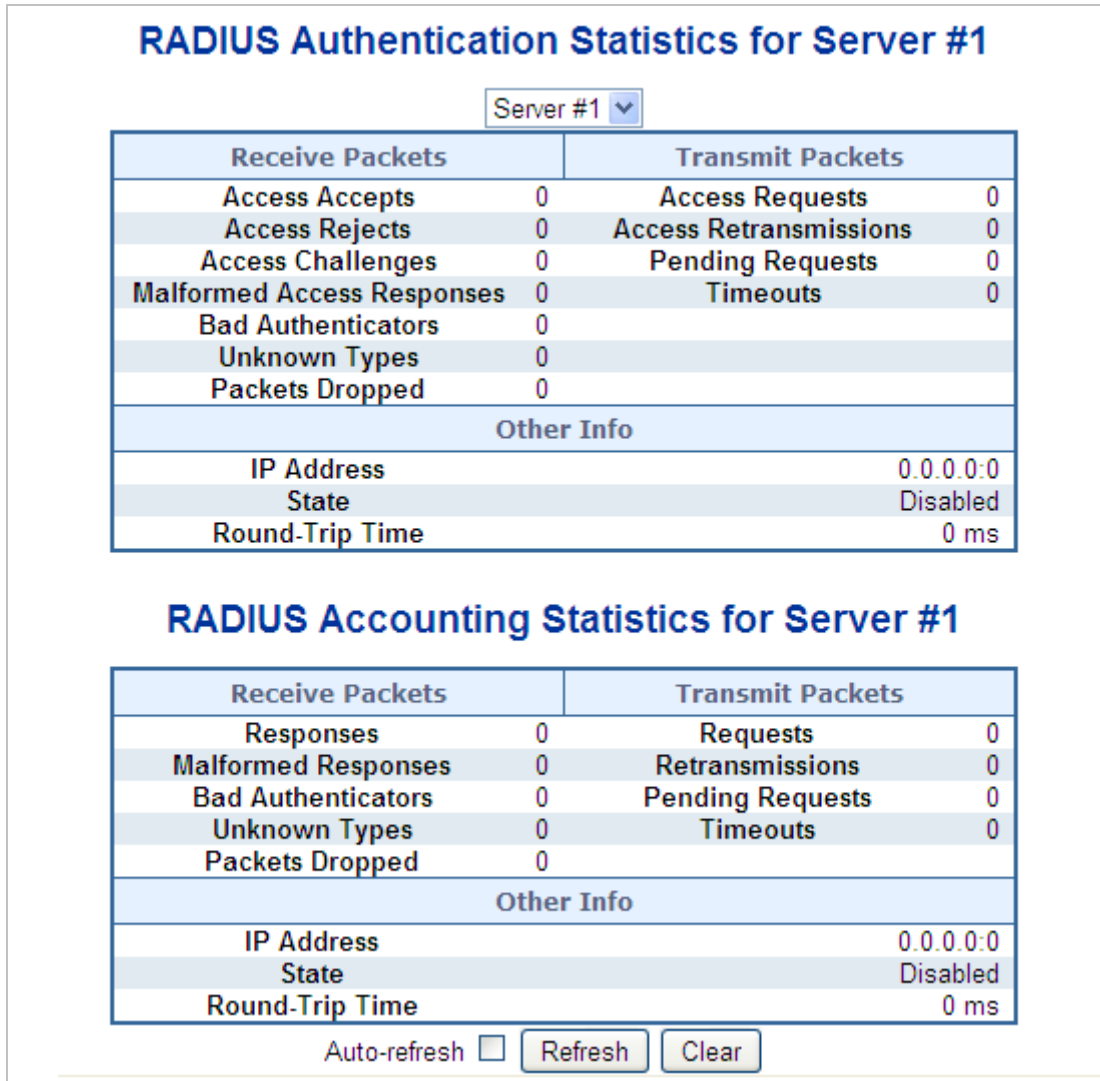

Figure 4-5-2-7: RADIUS Authentication/Accounting for Server Overview Screenshot

The page includes the following fields:

RADIUS Authentication Statistics

The statistics map closely to those specified in RFC4668 - RADIUS Authentication Client MIB. Use the server select box to switch between the backend servers to show details for.

| Object | Description | | | | | | | | |
|---|--|--------------------------------------|---|--------------|-------------|----|-----------------------|--------------------------------------|---|
| <ul style="list-style-type: none"> Packet Counters | <p>RADIUS authentication server packet counter. There are seven receive and four transmit counters.</p> <table border="1"> <thead> <tr> <th>Direction</th> <th>Name</th> <th>RFC4668 Name</th> <th>Description</th> </tr> </thead> <tbody> <tr> <td>Rx</td> <td>Access Accepts</td> <td>radiusAuthClientExtA ccessAccepts</td> <td>The number of RADIUS Access-Accept packets (valid or invalid) received from the server.</td> </tr> </tbody> </table> | Direction | Name | RFC4668 Name | Description | Rx | Access Accepts | radiusAuthClientExtA ccessAccepts | The number of RADIUS Access-Accept packets (valid or invalid) received from the server. |
| Direction | Name | RFC4668 Name | Description | | | | | | |
| Rx | Access Accepts | radiusAuthClientExtA ccessAccepts | The number of RADIUS Access-Accept packets (valid or invalid) received from the server. | | | | | | |

| | | | |
|----|-----------------------------------|---|--|
| Rx | Access Rejects | radiusAuthClientExtAccessRejects | The number of RADIUS Access-Reject packets (valid or invalid) received from the server. |
| Rx | Access Challenges | radiusAuthClientExtAccessChallenges | The number of RADIUS Access-Challenge packets (valid or invalid) received from the server. |
| Rx | Malformed Access Responses | radiusAuthClientExtMalformedAccessResponses | The number of malformed RADIUS Access-Response packets received from the server. Malformed packets include packets with an invalid length. Bad authenticators or Message Authenticator attributes or unknown types are not included as malformed access responses. |
| Rx | Bad Authenticators | radiusAuthClientExtBadAuthenticators | The number of RADIUS Access-Response packets containing invalid authenticators or Message Authenticator attributes received from the server. |
| Rx | Unknown Types | radiusAuthClientExtUnknownTypes | The number of RADIUS packets that were received from the server on the authentication port and dropped for some other reason. |
| Rx | Packets Dropped | radiusAuthClientExtPacketsDropped | The number of RADIUS packets that were received from the server on the authentication port and dropped for some other reason. |

| | | | | |
|---|---|-------------------------------|--|---|
| | Tx | Access Requests | radiusAuthClientExtAccessRequests | The number of RADIUS Access-Request packets sent to the server. This does not include retransmissions. |
| | Tx | Access Retransmissions | radiusAuthClientExtAccessRetransmissions | The number of RADIUS Access-Request packets retransmitted to the RADIUS authentication server. |
| | Tx | Pending Requests | radiusAuthClientExtPendingRequests | The number of RADIUS Access-Request packets destined for the server that have not yet timed out or received a response. This variable is incremented when an Access-Request is sent and decremented due to receipt of an Access-Accept, Access-Reject, Access-Challenge, timeout, or retransmission. |
| | Tx | Timeouts | radiusAuthClientExtTimeouts | The number of authentication timeouts to the server. After a timeout, the client may retry to the same server, send to a different server, or give up. A retry to the same server is counted as a retransmit as well as a timeout. A send to a different server is counted as a Request as well as a timeout. |
| <ul style="list-style-type: none"> • Other Info | This section contains information about the state of the server and the latest round-trip time. | | | |
| | | Name | RFC4668 Name | Description |
| IP Address | | - | | IP address and UDP port for the authentication server in question. |

| | | | |
|--|------------------------|--------------------------------------|--|
| | State | - | <p>Shows the state of the server. It takes one of the following values:</p> <ul style="list-style-type: none"> ■ Disabled: The selected server is disabled. ■ Not Ready: The server is enabled, but IP communication is not yet up and running. ■ Ready: The server is enabled, IP communication is up and running, and the RADIUS module is ready to accept access attempts. ■ Dead (X seconds left): Access attempts were made to this server, but it did not reply within the configured timeout. The server has temporarily been disabled, but will get re-enabled when the dead-time expires. The number of seconds left before this occurs is displayed in parentheses. This state is only reachable when more than one server is enabled. |
| | Round-Trip Time | radiusAuthClient ExtRoundTripTime | <p>The time interval (measured in milliseconds) between the most recent Access-Reply/Access-Challenge and the Access-Request that matched it from the RADIUS authentication server. The granularity of this measurement is 100 ms. A value of 0 ms indicates that there hasn't been round-trip communication with the server yet.</p> |

RADIUS Accounting Statistics

The statistics map closely to those specified in RFC4670 - RADIUS Accounting Client MIB. Use the server select box to switch between the backend servers to show details for.

| Object | Description | | | |
|--|---|--|---|---|
| <ul style="list-style-type: none"> • Packet Counters | RADIUS accounting server packet counter. There are five receive and four transmit counters. | | | |
| | Direction | Name | RFC4670 Name | Description |
| | Rx | Responses | radiusAccClientExt Responses | The number of RADIUS packets (valid or invalid) received from the server. |
| Rx | Malformed | radiusAccClientExt MalformedResponses | The number of malformed RADIUS packets received | |

| | | | |
|----|---------------------------|--|--|
| | Responses | es | from the server. Malformed packets include packets with an invalid length. Bad authenticators or unknown types are not included as malformed access responses. |
| Rx | Bad Authenticators | radiusAcctClientExt BadAuthenticators | The number of RADIUS packets containing invalid authenticators received from the server. |
| Rx | Unknown Types | radiusAccClientExt UnknownTypes | The number of RADIUS packets of unknown types that were received from the server on the accounting port. |
| Rx | Packets Dropped | radiusAccClientExt PacketsDropped | The number of RADIUS packets that were received from the server on the accounting port and dropped for some other reason. |
| Tx | Requests | radiusAccClientExt Requests | The number of RADIUS packets sent to the server. This does not include retransmissions. |
| Tx | Retransmissions | radiusAccClientExt Retransmissions | The number of RADIUS packets retransmitted to the RADIUS accounting server. |
| Tx | Pending Requests | radiusAccClientExt PendingRequests | The number of RADIUS packets destined for the server that have not yet timed out or received a response. This variable is incremented when a Request is sent and decremented due to receipt of a Response, timeout, or retransmission. |

| | <p>Tx Timeouts</p> <p>radiusAccClientExt The number of accounting Timeouts timeouts to the server. After a timeout, the client may retry to the same server, send to a different server, or give up. A retry to the same server is counted as a retransmit as well as a timeout. A send to a different server is counted as a Request as well as a timeout.</p> | | | | | | | | | | | | |
|----------------------------|---|--|--------------|-------------|-------------------|---|--|--------------|---|--|------------------------|---------------------------------|---|
| <p>• Other Info</p> | <p>This section contains information about the state of the server and the latest round-trip time.</p> <table border="1" data-bbox="523 779 1497 2040"> <thead> <tr> <th data-bbox="523 779 699 831">Name</th> <th data-bbox="699 779 965 831">RFC4670 Name</th> <th data-bbox="965 779 1497 831">Description</th> </tr> </thead> <tbody> <tr> <td data-bbox="523 831 699 936">IP Address</td> <td data-bbox="699 831 965 936">-</td> <td data-bbox="965 831 1497 936">IP address and UDP port for the accounting server in question.</td> </tr> <tr> <td data-bbox="523 936 699 1803">State</td> <td data-bbox="699 936 965 1803">-</td> <td data-bbox="965 936 1497 1803"> <p>Shows the state of the server. It takes one of the following values:</p> <ul style="list-style-type: none"> ■ Disabled: The selected server is disabled. ■ Not Ready: The server is enabled, but IP communication is not yet up and running. ■ Ready: The server is enabled, IP communication is up and running, and the RADIUS module is ready to accept accounting attempts. ■ Dead (X seconds left): Accounting attempts were made to this server, but it did not reply within the configured timeout. The server has temporarily been disabled, but will get re-enabled when the dead-time expires. The number of seconds left before this occurs is displayed in parentheses. This state is only reachable when more than one server is enabled. </td> </tr> <tr> <td data-bbox="523 1803 699 2040">Round-Trip Time</td> <td data-bbox="699 1803 965 2040">radiusAccClientExtRoundTripTime</td> <td data-bbox="965 1803 1497 2040"> <ul style="list-style-type: none"> ■ The time interval (measured in milliseconds) between the most recent Response and the Request that matched it from the RADIUS accounting server. The granularity of this measurement is </td> </tr> </tbody> </table> | Name | RFC4670 Name | Description | IP Address | - | IP address and UDP port for the accounting server in question. | State | - | <p>Shows the state of the server. It takes one of the following values:</p> <ul style="list-style-type: none"> ■ Disabled: The selected server is disabled. ■ Not Ready: The server is enabled, but IP communication is not yet up and running. ■ Ready: The server is enabled, IP communication is up and running, and the RADIUS module is ready to accept accounting attempts. ■ Dead (X seconds left): Accounting attempts were made to this server, but it did not reply within the configured timeout. The server has temporarily been disabled, but will get re-enabled when the dead-time expires. The number of seconds left before this occurs is displayed in parentheses. This state is only reachable when more than one server is enabled. | Round-Trip Time | radiusAccClientExtRoundTripTime | <ul style="list-style-type: none"> ■ The time interval (measured in milliseconds) between the most recent Response and the Request that matched it from the RADIUS accounting server. The granularity of this measurement is |
| Name | RFC4670 Name | Description | | | | | | | | | | | |
| IP Address | - | IP address and UDP port for the accounting server in question. | | | | | | | | | | | |
| State | - | <p>Shows the state of the server. It takes one of the following values:</p> <ul style="list-style-type: none"> ■ Disabled: The selected server is disabled. ■ Not Ready: The server is enabled, but IP communication is not yet up and running. ■ Ready: The server is enabled, IP communication is up and running, and the RADIUS module is ready to accept accounting attempts. ■ Dead (X seconds left): Accounting attempts were made to this server, but it did not reply within the configured timeout. The server has temporarily been disabled, but will get re-enabled when the dead-time expires. The number of seconds left before this occurs is displayed in parentheses. This state is only reachable when more than one server is enabled. | | | | | | | | | | | |
| Round-Trip Time | radiusAccClientExtRoundTripTime | <ul style="list-style-type: none"> ■ The time interval (measured in milliseconds) between the most recent Response and the Request that matched it from the RADIUS accounting server. The granularity of this measurement is | | | | | | | | | | | |

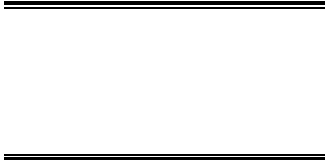

100 ms. A value of 0 ms indicates that there hasn't been round-trip communication with the server yet.

Buttons

Auto-refresh Check this box to refresh the page automatically. Automatic refresh occurs every 3 seconds.

: Click to refresh the page immediately.

: Clears the counters for the selected server. The "Pending Requests" counter will not be cleared by this operation.

4.5.3 Port Authentication

4.5.3.1 Network Access Server Configuration

This page allows you to configure the IEEE 802.1X and MAC-based authentication system and port settings. The IEEE 802.1X standard defines a port-based access control procedure that prevents unauthorized access to a network by requiring users to first submit credentials for authentication. One or more central servers, the backend servers, determine whether the user is allowed access to the network. These backend (RADIUS) servers are configured on the "Configuration→Security→AAA" Page. The IEEE802.1X standard defines port-based operation, but non-standard variants overcome security limitations as shall be explored below.

MAC-based authentication allows for authentication of more than one user on the same port, and doesn't require the user to have special 802.1X supplicant software installed on his system. The switch uses the user's MAC address to authenticate against the backend server. Intruders can create counterfeit MAC addresses, which makes MAC-based authentication less secure than 802.1X authentication. The NAS configuration consists of two sections, a system- and a port-wide. The Network Access Server Configuration screen in [Figure 4-5-3-1](#) appears.

Network Access Server Configuration

System Configuration

| | |
|---------------------------------------|---|
| Mode | Disabled ▼ |
| Reauthentication Enabled | <input type="checkbox"/> |
| Reauthentication Period | 3600 seconds |
| EAPOL Timeout | 30 seconds |
| Aging Period | 300 seconds |
| Hold Time | 10 seconds |
| RADIUS-Assigned QoS Enabled | <input type="checkbox"/> |
| RADIUS-Assigned VLAN Enabled | <input type="checkbox"/> |
| Guest VLAN Enabled | <input type="checkbox"/> |
| Guest VLAN ID | 1 |
| Max. Reauth. Count | 2 |
| Allow Guest VLAN if EAPOL Seen | <input type="checkbox"/> |

Port Configuration

| Port | Admin State | RADIUS-Assigned QoS Enabled | RADIUS-Assigned VLAN Enabled | Guest VLAN Enabled | Port State | Restart | |
|------|--------------------|-----------------------------|------------------------------|--------------------------|-------------------|----------------|--------------|
| * | <All> ▼ | <input type="checkbox"/> | <input type="checkbox"/> | <input type="checkbox"/> | | | |
| 1 | Force Authorized ▼ | <input type="checkbox"/> | <input type="checkbox"/> | <input type="checkbox"/> | Globally Disabled | Reauthenticate | Reinitialize |
| 2 | Force Authorized ▼ | <input type="checkbox"/> | <input type="checkbox"/> | <input type="checkbox"/> | Globally Disabled | Reauthenticate | Reinitialize |
| 3 | Force Authorized ▼ | <input type="checkbox"/> | <input type="checkbox"/> | <input type="checkbox"/> | Globally Disabled | Reauthenticate | Reinitialize |
| 4 | Force Authorized ▼ | <input type="checkbox"/> | <input type="checkbox"/> | <input type="checkbox"/> | Globally Disabled | Reauthenticate | Reinitialize |
| 5 | Force Authorized ▼ | <input type="checkbox"/> | <input type="checkbox"/> | <input type="checkbox"/> | Globally Disabled | Reauthenticate | Reinitialize |
| 6 | Force Authorized ▼ | <input type="checkbox"/> | <input type="checkbox"/> | <input type="checkbox"/> | Globally Disabled | Reauthenticate | Reinitialize |
| 7 | Force Authorized ▼ | <input type="checkbox"/> | <input type="checkbox"/> | <input type="checkbox"/> | Globally Disabled | Reauthenticate | Reinitialize |
| 8 | Force Authorized ▼ | <input type="checkbox"/> | <input type="checkbox"/> | <input type="checkbox"/> | Globally Disabled | Reauthenticate | Reinitialize |

Figure 4-5-3-1: Network Access Server Configuration Page Screenshot

The page includes the following fields:

System Configuration

| Object | Description |
|---|---|
| <ul style="list-style-type: none"> • Mode | <p>Indicates if NAS is globally enabled or disabled on the switch. If globally disabled, all ports are allowed forwarding of frames.</p> |
| <ul style="list-style-type: none"> • Reauthentication Enabled | <p>If checked, successfully authenticated supplicants/clients are reauthenticated after the interval specified by the Reauthentication Period. Reauthentication for 802.1X-enabled ports can be used to detect if a new device is plugged into a switch port or if a supplicant is no longer attached.</p> <p>For MAC-based ports, reauthentication is only useful if the RADIUS server configuration has changed. It does not involve communication between the switch and the client, and therefore doesn't imply that a client is still present on a port.</p> |
| <ul style="list-style-type: none"> • Reauthentication Period | <p>Determines the period, in seconds, after which a connected client must be reauthenticated. This is only active if the Reauthentication Enabled checkbox is checked. Valid values are in the range 1 to 3600 seconds.</p> |
| <ul style="list-style-type: none"> • EAPOL Timeout | <p>Determines the time for retransmission of Request Identity EAPOL frames. Valid values are in the range 1 to 65535 seconds. This has no effect for MAC-based ports.</p> |
| <ul style="list-style-type: none"> • Aging Period | <p>This setting applies to the following modes, i.e. modes using the Port Security functionality to secure MAC addresses:</p> <ul style="list-style-type: none"> ■ Single 802.1X ■ Multi 802.1X ■ MAC-Based Auth. <p>When the NAS module uses the Port Security module to secure MAC addresses, the Port Security module needs to check for activity on the MAC address in question at regular intervals and free resources if no activity is seen within a given period of time. This parameter controls exactly this period and can be set to a number between 10 and 1000000 seconds.</p> <p>If reauthentication is enabled and the port is in a 802.1X-based mode, this is not so critical, since supplicants that are no longer attached to the port will get removed upon the next reauthentication, which will fail. But if reauthentication is not enabled, the only way to free resources is by aging the entries.</p> <p>For ports in MAC-based Auth. mode, reauthentication doesn't cause direct</p> |

| | |
|---|---|
| | <p>communication between the switch and the client, so this will not detect whether the client is still attached or not, and the only way to free any resources is to age the entry.</p> |
| <ul style="list-style-type: none"> • Hold Time | <p>This setting applies to the following modes, i.e. modes using the Port Security functionality to secure MAC addresses:</p> <ul style="list-style-type: none"> ■ Single 802.1X ■ Multi 802.1X ■ MAC-Based Auth. <p>If a client is denied access, either because the RADIUS server denies the client access or because the RADIUS server request times out (according to the timeout specified on the "Configuration→Security→AAA" page), the client is put on hold in the Unauthorized state. The hold timer does not count during an on-going authentication.</p> <p>In MAC-based Auth. mode, the switch will ignore new frames coming from the client during the hold time.</p> <p>The Hold Time can be set to a number between 10 and 1000000 seconds.</p> |
| <ul style="list-style-type: none"> • RADIUS-Assigned QoS Enabled | <p>RADIUS-assigned QoS provides a means to centrally control the traffic class to which traffic coming from a successfully authenticated supplicant is assigned on the switch. The RADIUS server must be configured to transmit special RADIUS attributes to take advantage of this feature.</p> <p>The "RADIUS-Assigned QoS Enabled" checkbox provides a quick way to globally enable/disable RADIUS-server assigned QoS Class functionality. When checked, the individual ports' ditto setting determines whether RADIUS-assigned QoS Class is enabled for that port. When unchecked, RADIUS-server assigned QoS Class is disabled for all ports.</p> |
| <ul style="list-style-type: none"> • RADIUS-Assigned VLAN Enabled | <p>RADIUS-assigned VLAN provides a means to centrally control the VLAN on which a successfully authenticated supplicant is placed on the switch. Incoming traffic will be classified to and switched on the RADIUS-assigned VLAN. The RADIUS server must be configured to transmit special RADIUS attributes to take advantage of this feature.</p> <p>The "RADIUS-Assigned VLAN Enabled" checkbox provides a quick way to globally enable/disable RADIUS-server assigned VLAN functionality. When checked, the individual ports' ditto setting determines whether RADIUS-assigned VLAN is enabled for that port. When unchecked, RADIUS-server assigned VLAN is disabled for all ports.</p> |

| | |
|---|---|
| <ul style="list-style-type: none"> • Guest VLAN Enabled | <p>A Guest VLAN is a special VLAN - typically with limited network access - on which 802.1X-unaware clients are placed after a network administrator-defined timeout. The switch follows a set of rules for entering and leaving the Guest VLAN as listed below.</p> <p>The "Guest VLAN Enabled" checkbox provides a quick way to globally enable/disable Guest VLAN functionality. When checked, the individual ports' ditto setting determines whether the port can be moved into Guest VLAN. When unchecked, the ability to move to the Guest VLAN is disabled for all ports.</p> |
| <ul style="list-style-type: none"> • Guest VLAN ID | <p>This is the value that a port's Port VLAN ID is set to if a port is moved into the Guest VLAN. It is only changeable if the Guest VLAN option is globally enabled.</p> <p>Valid values are in the range [1; 4095].</p> |
| <ul style="list-style-type: none"> • Max. Reauth. Count | <p>The number of times that the switch transmits an EAPOL Request Identity frame without response before considering entering the Guest VLAN is adjusted with this setting. The value can only be changed if the Guest VLAN option is globally enabled.</p> <p>Valid values are in the range [1; 255].</p> |
| <ul style="list-style-type: none"> • Allow Guest VLAN if EAPOL Seen | <p>The switch remembers if an EAPOL frame has been received on the port for the life-time of the port. Once the switch considers whether to enter the Guest VLAN, it will first check if this option is enabled or disabled. If disabled (unchecked; default), the switch will only enter the Guest VLAN if an EAPOL frame has not been received on the port for the life-time of the port. If enabled (checked), the switch will consider entering the Guest VLAN even if an EAPOL frame has been received on the port for the life-time of the port.</p> <p>The value can only be changed if the Guest VLAN option is globally enabled.</p> |

4.5.3.2 Network Access Overview

This page provides an overview of the current NAS port states for the selected switch. The Network Access Overview screen in [Figure 4-5-3-2](#) appears.

| Port | Admin State | Port State | Last Source | Last ID | QoS Class | Port VLAN ID |
|------|------------------|-------------------|-------------|---------|-----------|--------------|
| 1 | Force Authorized | Globally Disabled | | | - | |
| 2 | Force Authorized | Globally Disabled | | | - | |
| 3 | Force Authorized | Globally Disabled | | | - | |
| 4 | Force Authorized | Globally Disabled | | | - | |
| 5 | Force Authorized | Globally Disabled | | | - | |
| 6 | Force Authorized | Globally Disabled | | | - | |
| 7 | Force Authorized | Globally Disabled | | | - | |
| 8 | Force Authorized | Globally Disabled | | | - | |

Figure 4-5-3-2: Network Access Server Switch Status Page Screenshot

The page includes the following fields:

| Object | Description |
|---|---|
| <ul style="list-style-type: none"> • Port | The switch port number. Click to navigate to detailed NAS statistics for this port. |
| <ul style="list-style-type: none"> • Admin State | The port's current administrative state. Refer to NAS Admin State for a description of possible values. |
| <ul style="list-style-type: none"> • Port State | The current state of the port. Refer to NAS Port State for a description of the individual states. |
| <ul style="list-style-type: none"> • Last Source | The source MAC address carried in the most recently received EAPOL frame for EAPOL-based authentication, and the most recently received frame from a new client for MAC-based authentication. |
| <ul style="list-style-type: none"> • Last ID | The user name (supplicant identity) carried in the most recently received Response Identity EAPOL frame for EAPOL-based authentication, and the source MAC address from the most recently received frame from a new client for MAC-based authentication. |
| <ul style="list-style-type: none"> • QoS Class | QoS Class assigned to the port by the RADIUS server if enabled. |
| <ul style="list-style-type: none"> • Port VLAN ID | <p>The VLAN ID that NAS has put the port in. The field is blank, if the Port VLAN ID is not overridden by NAS.</p> <p>If the VLAN ID is assigned by the RADIUS server, "(RADIUS-assigned)" is appended to the VLAN ID. Read more about RADIUS-assigned VLANs here.</p> <p>If the port is moved to the Guest VLAN, "(Guest)" is appended to the VLAN ID. Read more about Guest VLANs here.</p> |

Buttons

: Click to refresh the page immediately.

Auto-refresh : Check this box to refresh the page automatically. Automatic refresh occurs every 3 seconds.

4.5.3.3 Network Access Statistics

This page provides detailed NAS statistics for a specific switch port running EAPOL-based IEEE 802.1X authentication. For MAC-based ports, it shows selected backend server (RADIUS Authentication Server) statistics, only. Use the port select box to select which port details to be displayed. The Network Access Statistics screen in [Figure 4-5-3-3](#) appears.

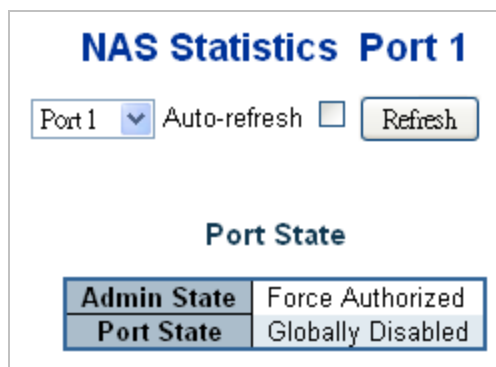

Figure 4-5-3-3: Network Access Statistics Page Screenshot

The page includes the following fields:

Port State

| Object | Description |
|-----------------------|--|
| • Admin State | The port's current administrative state. Refer to NAS Admin State for a description of possible values. |
| • Port State | The current state of the port. Refer to NAS Port State for a description of the individual states. |
| • QoS Class | The QoS class assigned by the RADIUS server. The field is blank if no QoS class is assigned. |
| • Port VLAN ID | The VLAN ID that NAS has put the port in. The field is blank, if the Port VLAN ID is not overridden by NAS. If the VLAN ID is assigned by the RADIUS server, "(RADIUS-assigned)" is appended to the VLAN ID. Read more about RADIUS-assigned VLANs here. If the port is moved to the Guest VLAN, "(Guest)" is appended to the VLAN ID. Read more about Guest VLANs here. |

Port Counters

| Object | Description | | | |
|---|---|---------------------------------|---|--|
| <ul style="list-style-type: none"> • EAPOL Counters | <p>These supplicant frame counters are available for the following administrative states:</p> <ul style="list-style-type: none"> ■ Force Authorized ■ Force Unauthorized ■ Port-based 802.1X ■ Single 802.1X ■ Multi 802.1X | | | |
| | Direction | Name | IEEE Name | Description |
| | Rx | Total | dot1xAuthEapolFramesRx | The number of valid EAPOL frames of any type that have been received by the switch. |
| | Rx | Response ID | dot1xAuthEapolRespIdFramesRx | The number of valid EAPOL Response Identity frames that have been received by the switch. |
| | Rx | Responses | dot1xAuthEapolRespFramesRx | The number of valid EAPOL response frames (other than Response Identity frames) that have been received by the switch. |
| | Rx | Start | dot1xAuthEapolStartFramesRx | The number of EAPOL Start frames that have been received by the switch. |
| | Rx | Logoff | dot1xAuthEapolLogoffFramesRx | The number of valid EAPOL Logoff frames that have been received by the switch. |
| | Rx | Invalid Type | dot1xAuthInvalidEapolFramesRx | The number of EAPOL frames that have been received by the switch in which the frame type is not recognized. |
| Rx | Invalid Length | dot1xAuthEapLengthErrorFramesRx | The number of EAPOL frames that have been received by the switch in | |

which the Packet Body Length field is invalid.

| | | | |
|----|-------------------|-----------------------------|---|
| Tx | Total | dot1xAuthEapolFramesTx | The number of EAPOL frames of any type that have been transmitted by the switch. |
| Tx | Request ID | dot1xAuthEapolReqIdFramesTx | The number of EAPOL Request Identity frames that have been transmitted by the switch. |
| Tx | Requests | dot1xAuthEapolReqFramesTx | The number of valid EAPOL Request frames (other than Request Identity frames) that have been transmitted by the switch. |

• **Backend Server Counters**

These backend (RADIUS) frame counters are available for the following administrative states:

- **Port-based 802.1X**
- **Single 802.1X**
- **Multi 802.1X**
- **MAC-based Auth.**

| Direction | Name | IEEE Name | Description |
|-----------|--------------------------|----------------------------------|---|
| Rx | Access Challenges | dot1xAuthBackendAccessChallenges | <p>802.1X-based: Counts the number of times that the switch receives the first request from the backend server following the first response from the supplicant. Indicates that the backend server has communication with the switch.</p> <p>MAC-based: Counts all Access Challenges received from the backend server for this port (left-most table) or client (right-most</p> |

| | | | |
|----|------------------------|--|---|
| | | | table). |
| Rx | Other Requests | dot1xAuthBackendOther RequestsToSupplicant | <p>802.1X-based: Counts the number of times that the switch sends an EAP Request packet following the first to the supplicant. Indicates that the backend server chose an EAP-method.</p> <p>MAC-based: Not applicable.</p> |
| Rx | Auth. Successes | dot1xAuthBackendAuth Successes | <p>802.1X- and MAC-based: Counts the number of times that the switch receives a success indication. Indicates that the supplicant/client has successfully authenticated to the backend server.</p> |
| Rx | Auth. Failures | dot1xAuthBackendAuth Fails | <p>802.1X- and MAC-based: Counts the number of times that the switch receives a failure message. This indicates that the supplicant/client has not authenticated to the backend server.</p> |
| Tx | Responses | dot1xAuthBackendResponses | <p>802.1X-based: Counts the number of times that the switch attempts to send a supplicant's first response packet to the backend server. Indicates the switch attempted communication with the backend server. Possible retransmissions are not counted.</p> <p>MAC-based: Counts all the backend server packets sent from the switch</p> |

| | <p>towards the backend server for a given port (left-most table) or client (right-most table). Possible retransmissions are not counted.</p> | | | | | | | | | | | | | | | |
|---|--|---|-----------|-------------|--------------------|-------------------------------|--|----------------|---|---|----------------|--------------------------------|---|-----------------|---|---|
| <p>• Last Supplicant/Client Info</p> | <p>Information about the last supplicant/client that attempted to authenticate. This information is available for the following administrative states:</p> <ul style="list-style-type: none"> ■ Port-based 802.1X ■ Single 802.1X ■ Multi 802.1X ■ MAC-based Auth. <table border="1" data-bbox="523 792 1493 1615"> <thead> <tr> <th data-bbox="523 792 675 842">Name</th> <th data-bbox="675 792 938 842">IEEE Name</th> <th data-bbox="938 792 1493 842">Description</th> </tr> </thead> <tbody> <tr> <td data-bbox="523 842 675 958">MAC Address</td> <td data-bbox="675 842 938 958">dot1xAuthLastEapolFrameSource</td> <td data-bbox="938 842 1493 958">The MAC address of the last supplicant/client.</td> </tr> <tr> <td data-bbox="523 958 675 1075">VLAN ID</td> <td data-bbox="675 958 938 1075">-</td> <td data-bbox="938 958 1493 1075">The VLAN ID on which the last frame from the last supplicant/client was received.</td> </tr> <tr> <td data-bbox="523 1075 675 1323">Version</td> <td data-bbox="675 1075 938 1323">dot1xAuthLastEapolFrameVersion</td> <td data-bbox="938 1075 1493 1323"> <p>802.1X-based: The protocol version number carried in the most recently received EAPOL frame.</p> <p>MAC-based: Not applicable.</p> </td> </tr> <tr> <td data-bbox="523 1323 675 1615">Identity</td> <td data-bbox="675 1323 938 1615">-</td> <td data-bbox="938 1323 1493 1615"> <p>802.1X-based: The user name (supplicant identity) carried in the most recently received Response Identity EAPOL frame.</p> <p>MAC-based: Not applicable.</p> </td> </tr> </tbody> </table> | Name | IEEE Name | Description | MAC Address | dot1xAuthLastEapolFrameSource | The MAC address of the last supplicant/client. | VLAN ID | - | The VLAN ID on which the last frame from the last supplicant/client was received. | Version | dot1xAuthLastEapolFrameVersion | <p>802.1X-based: The protocol version number carried in the most recently received EAPOL frame.</p> <p>MAC-based: Not applicable.</p> | Identity | - | <p>802.1X-based: The user name (supplicant identity) carried in the most recently received Response Identity EAPOL frame.</p> <p>MAC-based: Not applicable.</p> |
| Name | IEEE Name | Description | | | | | | | | | | | | | | |
| MAC Address | dot1xAuthLastEapolFrameSource | The MAC address of the last supplicant/client. | | | | | | | | | | | | | | |
| VLAN ID | - | The VLAN ID on which the last frame from the last supplicant/client was received. | | | | | | | | | | | | | | |
| Version | dot1xAuthLastEapolFrameVersion | <p>802.1X-based: The protocol version number carried in the most recently received EAPOL frame.</p> <p>MAC-based: Not applicable.</p> | | | | | | | | | | | | | | |
| Identity | - | <p>802.1X-based: The user name (supplicant identity) carried in the most recently received Response Identity EAPOL frame.</p> <p>MAC-based: Not applicable.</p> | | | | | | | | | | | | | | |

4.5.4 Port Security

4.5.4.1 Port Limit Control

This page allows you to configure the Port Security global and per-port settings.

Port Security allows for limiting the number of users on a given port. A user is identified by a MAC address and VLAN ID. If Port Security is enabled on a port, the limit specifies the maximum number of users on the port. If this number is exceeded, an action is taken depending on violation mode. The violation mode can be one of the four different described below.

The Port Security configuration consists of two sections, a global and a per-port.. The Port Limit Control Configuration screen in [Figure 4-5-4-1](#) appears.

Port Security Configuration

Global Configuration

| | |
|----------------------|--------------------------|
| Aging Enabled | <input type="checkbox"/> |
| Aging Period | 3600 seconds |
| Hold Time | 300 seconds |

Port Configuration

| Port | Mode | Limit | Violation Mode | Violation Limit | State |
|------|------------|-------|----------------|-----------------|----------|
| * | <All> ▼ | 4 | <All> ▼ | 4 | |
| 1 | Disabled ▼ | 4 | Protect ▼ | 4 | Disabled |
| 2 | Disabled ▼ | 4 | Protect ▼ | 4 | Disabled |
| 3 | Disabled ▼ | 4 | Protect ▼ | 4 | Disabled |
| 4 | Disabled ▼ | 4 | Protect ▼ | 4 | Disabled |
| 5 | Disabled ▼ | 4 | Protect ▼ | 4 | Disabled |
| 6 | Disabled ▼ | 4 | Protect ▼ | 4 | Disabled |
| 7 | Disabled ▼ | 4 | Protect ▼ | 4 | Disabled |
| 8 | Disabled ▼ | 4 | Protect ▼ | 4 | Disabled |
| 9 | Disabled ▼ | 4 | Protect ▼ | 4 | Disabled |
| 10 | Disabled ▼ | 4 | Protect ▼ | 4 | Disabled |

Figure 4-5-4-1: Port Limit Control Configuration Overview Page Screenshot

The page includes the following fields:

System Configuration

| Object | Description |
|--|--|
| <ul style="list-style-type: none"> Aging Enabled | If checked, secured MAC addresses are subject to aging as discussed under Aging Period . |

| | |
|---|--|
| <ul style="list-style-type: none"> • Aging Period | <p>If Aging Enabled is checked, then the aging period is controlled with this input. If other modules are using the underlying port security for securing MAC addresses, they may have other requirements to the aging period. The underlying port security will use the shorter requested aging period of all modules that use the functionality.</p> <p>The Aging Period can be set to a number between 10 and 10,000,000 seconds. To understand why aging may be desired, consider the following scenario: Suppose an end-host is connected to a 3rd party switch or hub, which in turn is connected to a port on this switch on which Limit Control is enabled. The end-host will be allowed to forward if the limit is not exceeded. Now suppose that the end-host logs off or powers down. If it wasn't for aging, the end-host would still take up resources on this switch and will be allowed to forward. To overcome this situation, enable aging. With aging enabled, a timer is started once the end-host gets secured. When the timer expires, the switch starts looking for frames from the end-host, and if such frames are not seen within the next Aging Period, the end-host is assumed to be disconnected, and the corresponding resources are freed on the switch.</p> |
| <ul style="list-style-type: none"> • Hold Time | <p>The hold time - measured in seconds - is used to determine how long a MAC address is held in the MAC table if it has been found to violate the limit. Valid range is between 10 and 10000000 seconds with a default of 300 seconds.</p> <p>The reason for holding a violating MAC address in the MAC table is primarily to ensure that the same MAC address doesn't give rise to continuous notifications (if notifications on violation count is enabled).</p> |

Port Configuration

The table has one row for each port and a number of columns, which are:

| Object | Description |
|--|--|
| <ul style="list-style-type: none"> • Port | <p>The port number for which the configuration below applies.</p> |
| <ul style="list-style-type: none"> • Mode | <p>Controls whether Limit Control is enabled on this port. Both this and the Global Mode must be set to Enabled for Limit Control to be in effect. Notice that other modules may still use the underlying port security features without enabling Limit Control on a given port.</p> |
| <ul style="list-style-type: none"> • Limit | <p>The maximum number of MAC addresses that can be secured on this port. This number cannot exceed 1024. If the limit is exceeded, the corresponding action is</p> |

| | |
|--|---|
| | <p>taken.</p> <p>The switch is "born" with a total number of MAC addresses from which all ports draw whenever a new MAC address is seen on a Port Security-enabled port. Since all ports draw from the same pool, it may happen that a configured maximum cannot be granted, if the remaining ports have already used all available MAC addresses.</p> |
| <ul style="list-style-type: none"> • Violation Mode | <p>If Limit is reached, the switch can take one of the following actions:</p> <p>Protect: Do not allow more than Limit MAC addresses on the port, but take no further action.</p> <p>Restrict: If Limit is reached, subsequent MAC addresses on the port will be counted and marked as violating. Such MAC addresses are removed from the MAC table when the hold time expires. At most Violation Limit MAC addresses can be marked as violating at any given time.</p> <p>Shutdown: If Limit is reached, one additional MAC address will cause the port to be shut down. This implies that all secured MAC addresses be removed from the port, and no new addresses be learned. There are three ways to re-open the port:</p> <ol style="list-style-type: none"> 1) In the "Configuration→Ports" page's "Configured" column, first disable the port, then restore the original mode. 2) Make a Port Security configuration change on the port. 3) Boot the switch. |
| <ul style="list-style-type: none"> • Violation Limit | <ul style="list-style-type: none"> ■ The maximum number of MAC addresses that can be marked as violating on this port. This number cannot exceed 1024. Default is 4. It is only used when Violation Mode is Restrict. |
| <ul style="list-style-type: none"> • State | <p>This column shows the current state of the port as seen from the Limit Control's point of view. The state takes one of four values:</p> <ul style="list-style-type: none"> ■ Disabled: Limit Control is either globally disabled or disabled on the port. ■ Ready: The limit is not yet reached. This can be shown for all actions. ■ Limit Reached: Indicates that the limit is reached on this port. This state can only be shown if Action is set to None or Trap. <p>Shutdown: Indicates that the port is shut down by the Limit Control module. This state can only be shown if Action is set to Shutdown or Trap & Shutdown.</p> |

Buttons

Apply : Click to apply changes

Reset : Click to undo any changes made locally and revert to previously saved values.

Refresh : Click to refresh the page. Note that non-committed changes will be lost.

4.5.4.2 Port Security Status

This page shows the Port Security status. Port Security is a module with no direct configuration. Configuration comes indirectly from other modules - the user modules. When a user module has enabled port security on a port, the port is set-up for software-based learning. In this mode, frames from unknown MAC addresses are passed on to the port security module, which in turn asks all user modules whether to allow this new MAC address to forward or block it. For a MAC address to be set in the forwarding state, all enabled user modules must unanimously agree on allowing the MAC address to forward. If only one chooses to block it, it will be blocked until that user module decides otherwise.

The status page is divided into two sections - one with a legend of user modules and one with the actual port status. The Port Security Status screen in [Figure 4-5-4-2](#) appears.

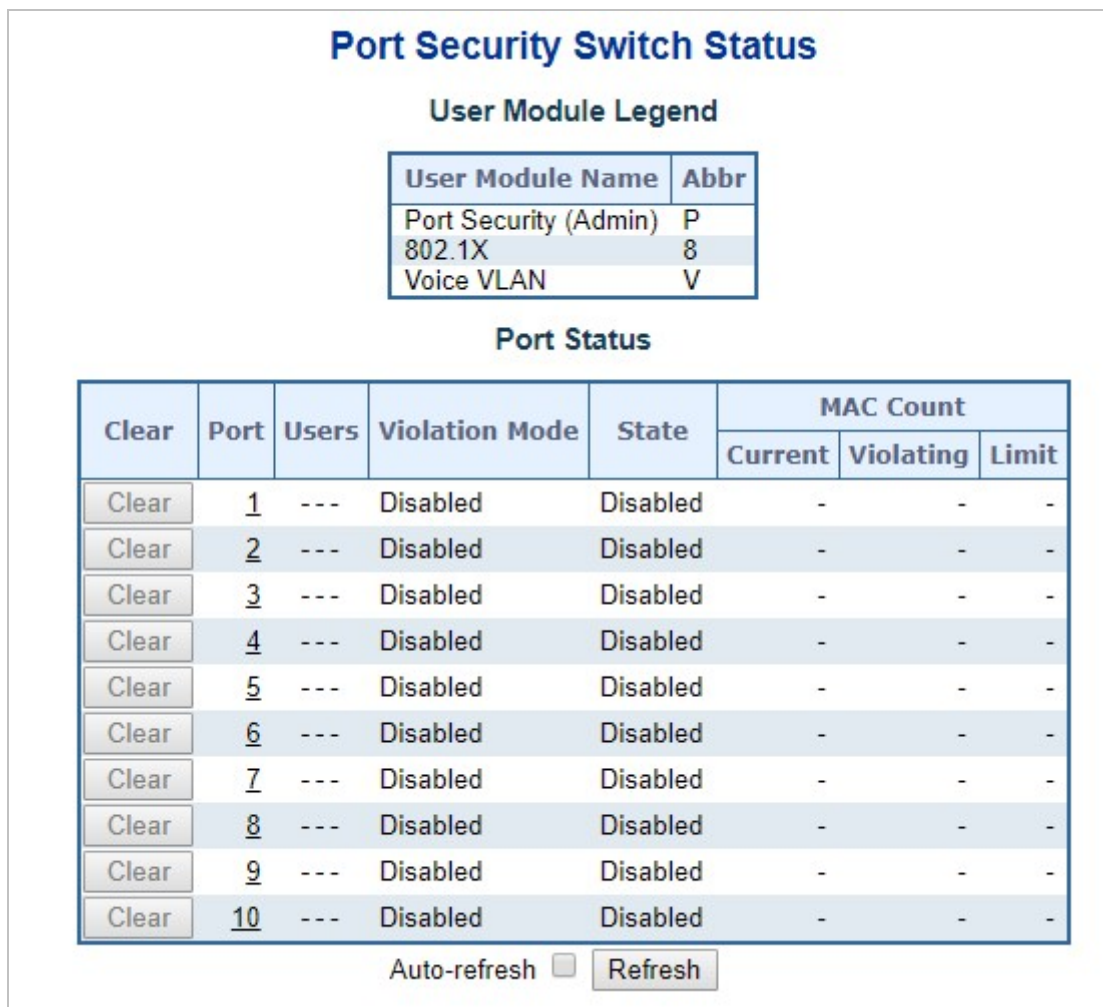

Figure 4-5-4-2: Port Security Status Screen Page Screenshot

The page includes the following fields:

User Module Legend

The legend shows all user modules that may request Port Security services.

| Object | Description |
|---|--|
| <ul style="list-style-type: none"> User Module Name | The full name of a module that may request Port Security services. |
| <ul style="list-style-type: none"> Abbr | A one-letter abbreviation of the user module. This is used in the Users column in the port status table. |

Port Status

The table has one row for each port on the selected switch in the switch and a number of columns, which are:

| Object | Description |
|---|---|
| <ul style="list-style-type: none"> Clear | Click to remove all MAC addresses on all VLANs on this port. The button is only clickable if number of secured MAC addresses is non-zero. |
| <ul style="list-style-type: none"> Port | The port number for which the status applies. Click the port number to see the status for this particular port. |
| <ul style="list-style-type: none"> Users | Each of the user modules has a column that shows whether that module has enabled Port Security or not. A '-' means that the corresponding user module is not enabled, whereas a letter indicates that the user module abbreviated by that letter has enabled port security. |
| <ul style="list-style-type: none"> Violation Mode | Shows the configured Violation Mode of the port. It can take one of four values: Disabled: Port Security is not administratively enabled on this port. Protect: Port Security is administratively enabled in Protect mode. Restrict: Port Security is administratively enabled in Restrict mode. Shutdown: Port Security is administratively enabled in Shutdown mode. |
| <ul style="list-style-type: none"> State | Shows the current state of the port. It can take one of four values: <ul style="list-style-type: none"> ■ Disabled: No user modules are currently using the Port Security service. ■ Ready: The Port Security service is in use by at least one user module, and is awaiting frames from unknown MAC addresses to arrive. ■ Limit Reached: The Port Security service is enabled by at least the Limit Control user module, and that module has indicated that the limit is reached and no more MAC addresses should be taken in. ■ Shutdown: The Port Security service is enabled by at least the Limit Control user module, and that module has indicated that the limit is exceeded. No MAC addresses can be learned on the port until it is administratively |

| | |
|---|---|
| | re-opened on the Limit Control configuration web page. |
| <ul style="list-style-type: none"> • MAC Count (Current, Limit) | <p>The two columns indicate the number of currently learned MAC addresses (forwarding as well as blocked) and the maximum number of MAC addresses that can be learned on the port, respectively.</p> <p>If no user modules are enabled on the port, the Current column will show a dash (-).</p> <p>If the Limit Control user module is not enabled on the port, the Limit column will show a dash (-).</p> |

Buttons

Auto-refresh : Check this box to refresh the page automatically. Automatic refresh occurs every 3 seconds.

: Click to refresh the page immediately.

4.5.4.3 Port Security Detail

This page shows the MAC addresses secured by the Port Security module. Port Security is a module with no direct configuration. Configuration comes indirectly from other modules - the user modules. When a user module has enabled port security on a port, the port is set-up for software-based learning. In this mode, frames from unknown MAC addresses are passed on to the port security module, which in turn asks all user modules whether to allow this new MAC address to forward or block it. For a MAC address to be set in the forwarding state, all enabled user modules must unanimously agree on allowing the MAC address to forward. If only one chooses to block it, it will be blocked until that user module decides otherwise. The Port Security Detail screen in [Figure 4-5-4-3](#) appears.

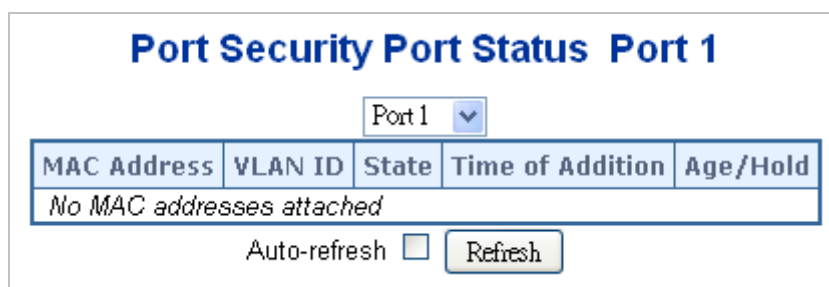

Figure 4-5-4-3: Port Security Detail Screen Page Screenshot

The page includes the following fields:

| Object | Description |
|--|--|
| <ul style="list-style-type: none"> • MAC Address & VLAN ID | The MAC address and VLAN ID that is seen on this port. If no MAC addresses are learned, a single row stating "No MAC addresses attached" is displayed. |
| <ul style="list-style-type: none"> • State | Indicates whether the corresponding MAC address is blocked or forwarding. In the blocked state, it will not be allowed to transmit or receive traffic. |

| | |
|---|--|
| <ul style="list-style-type: none">• Time of Addition | Shows the date and time when this MAC address was first seen on the port. |
| <ul style="list-style-type: none">• Age/Hold | <ul style="list-style-type: none">● If at least one user module has decided to block this MAC address, it will stay in the blocked state until the hold time (measured in seconds) expires.● If all user modules have decided to allow this MAC address to forward, and aging is enabled, the Port Security module will periodically check that this MAC address still forwards traffic.● If the age period (measured in seconds) expires and no frames have been seen, the MAC address will be removed from the MAC table. Otherwise a new age period will begin.● If aging is disabled or a user module has decided to hold the MAC address indefinitely, a dash (-) will be shown. |

4.5.5 Access Control Lists

ACL is an acronym for Access Control List. It is the list table of ACEs, containing access control entries that specify individual users or groups permitted or denied to specific traffic objects, such as a process or a program.

Each accessible traffic object contains an identifier to its ACL. The privileges determine whether there are specific traffic object access rights.

ACL implementations can be quite complex, for example, when the ACEs are prioritized for the various situation. In networking, the ACL refers to a list of service ports or network services that are available on a host or server, each with a list of hosts or servers permitted or denied to use the service. ACL can generally be configured to control inbound traffic, and in this context, they are similar to firewalls.

ACE is an acronym for **Access Control Entry**. It describes access permission associated with a particular ACE ID.

There are three ACE frame types (**Ethernet Type**, **ARP**, and **IPv4**) and two ACE actions (**permit** and **deny**). The ACE also contains many detailed, different parameter options that are available for individual application.

4.5.5.1 Access Control List Status

This page shows the ACL status by different ACL users. Each row describes the ACE that is defined. It is a conflict if a specific ACE is not applied to the hardware due to hardware limitations. The maximum number of ACEs is **512** on each switch. The Voice VLAN OUI Table screen in [Figure 4-5-5-1](#) appears.

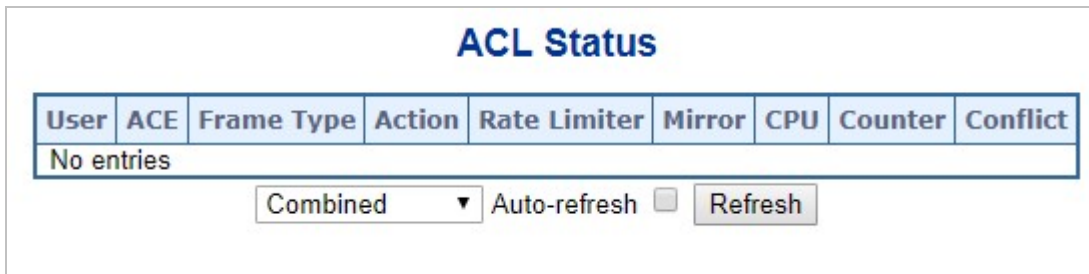

Figure 4-5-5-1: ACL Status Page Screenshot

The page includes the following fields:

| Object | Description |
|---------------------|---|
| • User | Indicates the ACL user. |
| • ACE | Indicates the ACE ID on local switch. |
| • Frame Type | Indicates the frame type of the ACE. Possible values are: <ul style="list-style-type: none"> ■ Any: The ACE will match any frame type. ■ EType: The ACE will match Ethernet Type frames. Note that an Ethernet Type based ACE will not get matched by IP and ARP frames. ■ ARP: The ACE will match ARP/RARP frames. |

| | |
|-----------------------|---|
| | <ul style="list-style-type: none"> ■ IPv4: The ACE will match all IPv4 frames. ■ IPv4/ICMP: The ACE will match IPv4 frames with ICMP protocol. ■ IPv4/UDP: The ACE will match IPv4 frames with UDP protocol. ■ IPv4/TCP: The ACE will match IPv4 frames with TCP protocol. ■ IPv4/Other: The ACE will match IPv4 frames, which are not ICMP/UDP/TCP. ■ IPv6: The ACE will match all IPv6 standard frames. |
| • Action | <p>Indicates the forwarding action of the ACE.</p> <ul style="list-style-type: none"> ■ Permit: Frames matching the ACE may be forwarded and learned. ■ Deny: Frames matching the ACE are dropped. |
| • Rate Limiter | <p>Indicates the rate limiter number of the ACE. The allowed range is 1 to 16. When Disabled is displayed, the rate limiter operation is disabled.</p> |
| • CPU | <p>Forward packet that matched the specific ACE to CPU</p> |
| • Counter | <p>The counter indicates the number of times the ACE was hit by a frame.</p> |
| • Conflict | <p>Indicates the hardware status of the specific ACE. The specific ACE is not applied to the hardware due to hardware limitations.</p> |

Buttons

Auto-refresh Check this box to refresh the page automatically. Automatic refresh occurs every 3 seconds.

: Click to refresh the page.

4.5.5.2 Access Control List Configuration

This page shows the Access Control List (ACL), which is made up of the ACEs defined on this switch. Each row describes the ACE that is defined. The maximum number of ACEs is **512** on each switch.

Click on the lowest plus sign to add a new ACE to the list. The reserved ACEs used for internal protocol, cannot be edited or deleted, the order sequence cannot be changed and the priority is highest. The Access Control List Configuration screen in [Figure 4-5-5-2](#) appears.

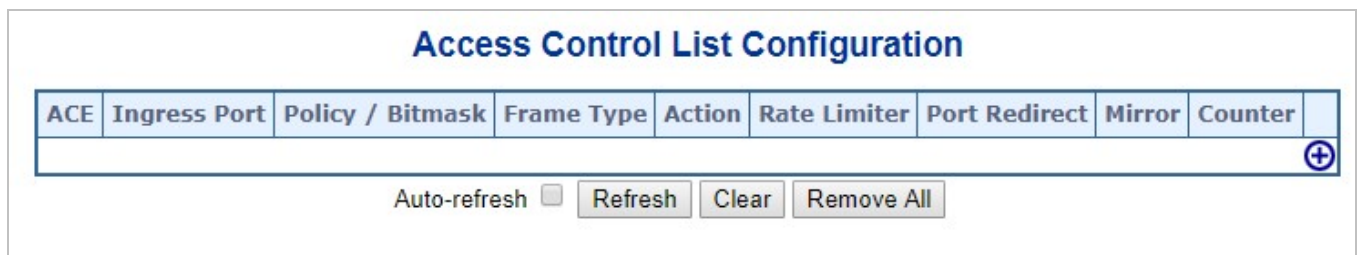







Figure 4-5-5-2: Access Control List Configuration Page Screenshot

The page includes the following fields:

| Object | Description |
|-------------------------------|--|
| • ACE | Indicates the ACE ID. |
| • Ingress Port | Indicates the ingress port of the ACE. Possible values are: <ul style="list-style-type: none"> ■ All: The ACE will match all ingress port. ■ Port: The ACE will match a specific ingress port. |
| • Policy / Bitmask | Indicates the policy number and bitmask of the ACE. |
| • Frame Type | Indicates the frame type of the ACE. Possible values are: <ul style="list-style-type: none"> ■ Any: The ACE will match any frame type. ■ EType: The ACE will match Ethernet Type frames. Note that an Ethernet Type based ACE will not get matched by IP and ARP frames. ■ ARP: The ACE will match ARP/RARP frames. ■ IPv4: The ACE will match all IPv4 frames. ■ IPv4/ICMP: The ACE will match IPv4 frames with ICMP protocol. ■ IPv4/UDP: The ACE will match IPv4 frames with UDP protocol. ■ IPv4/TCP: The ACE will match IPv4 frames with TCP protocol. ■ IPv4/Other: The ACE will match IPv4 frames, which are not ICMP/UDP/TCP. ■ IPv6: The ACE will match all IPv6 standard frames. |
| • Action | Indicates the forwarding action of the ACE. <ul style="list-style-type: none"> ■ Permit: Frames matching the ACE may be forwarded and learned. ■ Deny: Frames matching the ACE are dropped. ■ Filter: Frames matching the ACE are filtered. |
| • Rate Limiter | Indicates the rate limiter number of the ACE. The allowed range is 1 to 16. When Disabled is displayed, the rate limiter operation is disabled. |
| • Port Redirect | Indicates the port redirect operation of the ACE. Frames matching the ACE are redirected to the port number. The allowed values are Disabled or a specific port number. When Disabled is displayed, the port redirect operation is disabled. |
| • Mirror | Specify the mirror operation of this port. Frames matching the ACE are mirrored to the destination mirror port. The allowed values are: Enabled : Frames received on the port are mirrored. Disabled : Frames received on the port are not mirrored. The default value is "Disabled". |
| • Counter | The counter indicates the number of times the ACE was hit by a frame. |
| • Modification Buttons | You can modify each ACE (Access Control Entry) in the table using the following buttons: |

| | |
|--|---|
| | <ul style="list-style-type: none"> : Inserts a new ACE before the current row. : Edits the ACE row. : Moves the ACE up the list. : Moves the ACE down the list. : Deletes the ACE. : The lowest plus sign adds a new entry at the bottom of the ACE listings. |
|--|---|

Buttons

Auto-refresh Check this box to refresh the page automatically. Automatic refresh occurs every 3 seconds.

: Click to refresh the page; any changes made locally will be undone.

: Click to clear the counters.

: Click to remove all ACEs.

4.5.5.3 ACE Configuration

Configure an **ACE (Access Control Entry)** on this page. An ACE consists of several parameters. These parameters vary according to the frame type that you select. First select the ingress port for the ACE, and then select the frame type. Different parameter options are displayed depending on the frame type selected. A frame that hits this ACE matches the configuration that is defined here. The ACE Configuration screen in [Figure 4-5-5-3](#) appears.

ACE Configuration

| | | | |
|----------------------|-------|---------------------|------------|
| Ingress Port | All ▼ | Action | Permit ▼ |
| Policy Filter | Any ▼ | Rate Limiter | Disabled ▼ |
| Frame Type | Any ▼ | Mirror | Disabled ▼ |
| | | Logging | Disabled ▼ |
| | | Shutdown | Disabled ▼ |
| | | Counter | 0 |

VLAN Parameters

| | |
|-----------------------|-------|
| 802.1Q Tagged | Any ▼ |
| VLAN ID Filter | Any ▼ |
| Tag Priority | Any ▼ |

Figure 4-5-5-3: ACE Configuration Page Screenshot

The page includes the following fields:

| Object | Description |
|---|--|
| <ul style="list-style-type: none"> • Ingress Port | <p>Select the ingress port for which this ACE applies.</p> <ul style="list-style-type: none"> ■ Any: The ACE applies to any port. ■ Port n: The ACE applies to this port number, where n is the number of the switch port. |
| <ul style="list-style-type: none"> • Policy Filter | <p>Specify the policy number filter for this ACE.</p> <ul style="list-style-type: none"> ■ Any: No policy filter is specified. (policy filter status is "don't-care".) ■ Specific: If you want to filter a specific policy with this ACE, choose this value. Two field for entering an policy value and bitmask appears. |
| <ul style="list-style-type: none"> • Policy Value | <p>When "Specific" is selected for the policy filter, you can enter a specific policy value. The allowed range is 0 to 255.</p> |
| <ul style="list-style-type: none"> • Policy Bitmask | <p>When "Specific" is selected for the policy filter, you can enter a specific policy bitmask. The allowed range is 0x0 to 0xff.</p> |
| <ul style="list-style-type: none"> • Frame Type | <p>Select the frame type for this ACE. These frame types are mutually exclusive.</p> <ul style="list-style-type: none"> ■ Any: Any frame can match this ACE. ■ Ethernet Type: Only Ethernet Type frames can match this ACE. The IEEE 802.3 describes the value of Length/Type Field specifications to be greater than or equal to 1536 decimal (equal to 0600 hexadecimal). ■ ARP: Only ARP frames can match this ACE. Notice the ARP frames won't match the ACE with Ethernet type. ■ IPv4: Only IPv4 frames can match this ACE. Notice the IPv4 frames won't match the ACE with Ethernet type. ■ IPv6: Only IPv6 frames can match this ACE. Notice the IPv6 frames won't match the ACE with Ethernet type. |
| <ul style="list-style-type: none"> • Action | <p>Specify the action to take with a frame that hits this ACE.</p> <ul style="list-style-type: none"> ■ Permit: The frame that hits this ACE is granted permission for the ACE operation. ■ Deny: The frame that hits this ACE is dropped. |
| <ul style="list-style-type: none"> • Rate Limiter | <p>Specify the rate limiter in number of base units. The allowed range is 1 to 16. Disabled indicates that the rate limiter operation is disabled.</p> |
| <ul style="list-style-type: none"> • Port Redirect | <p>Frames that hit the ACE are redirected to the port number specified here. The allowed range is the same as the switch port number range. Disabled indicates that the port redirect operation is disabled.</p> |
| <ul style="list-style-type: none"> • Mirror | <p>Specify the mirror operation of this port. Frames matching the ACE are mirrored to the destination mirror port. The rate limiter will not affect frames on the mirror port. The allowed values are:</p> |

| | |
|---|---|
| | <p>Enabled: Frames received on the port are mirrored.</p> <p>Disabled: Frames received on the port are not mirrored.</p> <p>The default value is "Disabled"</p> |
| <ul style="list-style-type: none"> • Logging | <p>Specify the logging operation of the ACE. The allowed values are:</p> <ul style="list-style-type: none"> ■ Enabled: Frames matching the ACE are stored in the System Log. ■ Disabled: Frames matching the ACE are not logged. <p>Note: The logging feature only works when the packet length is less than 1518(without VLAN tags) and the System Log memory size and logging rate is limited.</p> |
| <ul style="list-style-type: none"> • Shutdown | <p>Specify the port shut down operation of the ACE. The allowed values are:</p> <ul style="list-style-type: none"> ■ Enabled: If a frame matches the ACE, the ingress port will be disabled. ■ Disabled: Port shut down is disabled for the ACE. <p>Note: The shutdown feature only works when the packet length is less than 1518(without VLAN tags).</p> |
| <ul style="list-style-type: none"> • Counter | <p>The counter indicates the number of times the ACE was hit by a frame.</p> |

■ **MAC Parameters**

| Object | Description |
|--|---|
| <ul style="list-style-type: none"> • SMAC Filter | <p>(Only displayed when the frame type is Ethernet Type or ARP.)</p> <p>Specify the source MAC filter for this ACE.</p> <ul style="list-style-type: none"> ■ Any: No SMAC filter is specified. (SMAC filter status is "don't-care".) ■ Specific: If you want to filter a specific source MAC address with this ACE, choose this value. A field for entering an SMAC value appears. |
| <ul style="list-style-type: none"> • SMAC Value | <p>When "Specific" is selected for the SMAC filter, you can enter a specific source MAC address. The legal format is "xx-xx-xx-xx-xx-xx" or "xx.xx.xx.xx.xx.xx" or "xxxxxxxxxxx" (x is a hexadecimal digit). A frame that hits this ACE matches this SMAC value.</p> |
| <ul style="list-style-type: none"> • DMAC Filter | <p>Specify the destination MAC filter for this ACE.</p> <ul style="list-style-type: none"> ■ Any: No DMAC filter is specified. (DMAC filter status is "don't-care".) ■ MC: Frame must be multicast. ■ BC: Frame must be broadcast. ■ UC: Frame must be unicast. ■ Specific: If you want to filter a specific destination MAC address with this ACE, choose this value. A field for entering a DMAC value appears. |
| <ul style="list-style-type: none"> • DMAC Value | <p>When "Specific" is selected for the DMAC filter, you can enter a specific destination MAC address. The legal format is "xx-xx-xx-xx-xx-xx" or "xx.xx.xx.xx.xx.xx" or "xxxxxxxxxxx" (x is a hexadecimal digit). A frame that hits this ACE matches this</p> |

| | |
|--|-------------|
| | DMAC value. |
|--|-------------|

■ VLAN Parameters

| Object | Description |
|---|--|
| <ul style="list-style-type: none"> • 802.1Q Tagged | <p>Specify whether frames can hit the action according to the 802.1Q tagged. The allowed values are:</p> <p>Any: Any value is allowed ("don't-care").</p> <p>Enabled: Tagged frame only.</p> <p>Disabled: Untagged frame only.</p> <p>The default value is "Any".</p> |
| <ul style="list-style-type: none"> • VLAN ID Filter | <p>Specify the VLAN ID filter for this ACE.</p> <ul style="list-style-type: none"> ■ Any: No VLAN ID filter is specified. (VLAN ID filter status is "don't-care".) ■ Specific: If you want to filter a specific VLAN ID with this ACE, choose this value. A field for entering a VLAN ID number appears. |
| <ul style="list-style-type: none"> • VLAN ID | <p>When "Specific" is selected for the VLAN ID filter, you can enter a specific VLAN ID number. The allowed range is 1 to 4095. A frame that hits this ACE matches this VLAN ID value.</p> |
| <ul style="list-style-type: none"> • Tag Priority | <p>Specify the tag priority for this ACE. A frame that hits this ACE matches this tag priority. The allowed number range is 0 to 7. The value Any means that no tag priority is specified (tag priority is "don't-care".)</p> |

■ ARP Parameters

The ARP parameters can be configured when Frame Type "ARP" is selected.

| Object | Description |
|---|---|
| <ul style="list-style-type: none"> • ARP/RARP | <p>Specify the available ARP/RARP opcode (OP) flag for this ACE.</p> <ul style="list-style-type: none"> ■ Any: No ARP/RARP OP flag is specified. (OP is "don't-care".) ■ ARP: Frame must have ARP/RARP opcode set to ARP. ■ RARP: Frame must have ARP/RARP opcode set to RARP. ■ Other: Frame has unknown ARP/RARP Opcode flag. |
| <ul style="list-style-type: none"> • Request/Reply | <p>Specify the available ARP/RARP opcode (OP) flag for this ACE.</p> <ul style="list-style-type: none"> ■ Any: No ARP/RARP OP flag is specified. (OP is "don't-care".) ■ Request: Frame must have ARP Request or RARP Request OP flag set. ■ Reply: Frame must have ARP Reply or RARP Reply OP flag. |
| <ul style="list-style-type: none"> • Sender IP Filter | <p>Specify the sender IP filter for this ACE.</p> <ul style="list-style-type: none"> ■ Any: No sender IP filter is specified. (Sender IP filter is "don't-care".) |

| | |
|--------------------------------|--|
| | <ul style="list-style-type: none"> ■ Host: Sender IP filter is set to Host. Specify the sender IP address in the SIP Address field that appears. ■ Network: Sender IP filter is set to Network. Specify the sender IP address and sender IP mask in the SIP Address and SIP Mask fields that appear. |
| • Sender IP Address | When "Host" or "Network" is selected for the sender IP filter, you can enter a specific sender IP address in dotted decimal notation. |
| • Sender IP Mask | When "Network" is selected for the sender IP filter, you can enter a specific sender IP mask in dotted decimal notation. |
| • Target IP Filter | <p>Specify the target IP filter for this specific ACE.</p> <ul style="list-style-type: none"> ■ Any: No target IP filter is specified. (Target IP filter is "don't-care".) ■ Host: Target IP filter is set to Host. Specify the target IP address in the Target IP Address field that appears. ■ Network: Target IP filter is set to Network. Specify the target IP address and target IP mask in the Target IP Address and Target IP Mask fields that appear. |
| • Target IP Address | When "Host" or "Network" is selected for the target IP filter, you can enter a specific target IP address in dotted decimal notation. |
| • Target IP Mask | When "Network" is selected for the target IP filter, you can enter a specific target IP mask in dotted decimal notation. |
| • ARP Sender MAC Match | <p>Specify whether frames can hit the action according to their sender hardware address field (SHA) settings.</p> <ul style="list-style-type: none"> ■ 0: ARP frames where SHA is not equal to the SMAC address. ■ 1: ARP frames where SHA is equal to the SMAC address. ■ Any: Any value is allowed ("don't-care"). |
| • RARP Target MAC Match | <p>Specify whether frames can hit the action according to their target hardware address field (THA) settings.</p> <ul style="list-style-type: none"> ■ 0: RARP frames where THA is not equal to the SMAC address. ■ 1: RARP frames where THA is equal to the SMAC address. ■ Any: Any value is allowed ("don't-care"). |
| • IP/Ethernet Length | <p>Specify whether frames can hit the action according to their ARP/RARP hardware address length (HLN) and protocol address length (PLN) settings.</p> <ul style="list-style-type: none"> ■ 0: ARP/RARP frames where the HLN is equal to Ethernet (0x06) and the (PLN) is equal to IPv4 (0x04). ■ 1: ARP/RARP frames where the HLN is equal to Ethernet (0x06) and the (PLN) is equal to IPv4 (0x04). ■ Any: Any value is allowed ("don't-care"). |
| • IP | <p>Specify whether frames can hit the action according to their ARP/RARP hardware address space (HRD) settings.</p> <ul style="list-style-type: none"> ■ 0: ARP/RARP frames where the HLD is equal to Ethernet (1). |

| | |
|---|--|
| | <ul style="list-style-type: none"> ■ 1: ARP/RARP frames where the HLD is equal to Ethernet (1). ■ Any: Any value is allowed ("don't-care"). |
| <ul style="list-style-type: none"> • Ethernet | <p>Specify whether frames can hit the action according to their ARP/RARP protocol address space (PRO) settings.</p> <ul style="list-style-type: none"> ■ 0: ARP/RARP frames where the PRO is equal to IP (0x800). ■ 1: ARP/RARP frames where the PRO is equal to IP (0x800). ■ Any: Any value is allowed ("don't-care"). |

■ **IP Parameters**

The IP parameters can be configured when Frame Type "IPv4" is selected.

| Object | Description |
|---|--|
| <ul style="list-style-type: none"> • IP Protocol Filter | <p>Specify the IP protocol filter for this ACE.</p> <ul style="list-style-type: none"> ■ Any: No IP protocol filter is specified ("don't-care"). ■ Specific: If you want to filter a specific IP protocol filter with this ACE, choose this value. A field for entering an IP protocol filter appears. ■ ICMP: Select ICMP to filter IPv4 ICMP protocol frames. Extra fields for defining ICMP parameters will appear. These fields are explained later in this help file. ■ UDP: Select UDP to filter IPv4 UDP protocol frames. Extra fields for defining UDP parameters will appear. These fields are explained later in this help file. ■ TCP: Select TCP to filter IPv4 TCP protocol frames. Extra fields for defining TCP parameters will appear. These fields are explained later in this help file. |
| <ul style="list-style-type: none"> • IP Protocol Value | <p>When "Specific" is selected for the IP protocol value, you can enter a specific value. The allowed range is 0 to 255. A frame that hits this ACE matches this IP protocol value.</p> |
| <ul style="list-style-type: none"> • IP TTL | <p>Specify the Time-to-Live settings for this ACE.</p> <ul style="list-style-type: none"> ■ zero: IPv4 frames with a Time-to-Live field greater than zero must not be able to match this entry. ■ non-zero: IPv4 frames with a Time-to-Live field greater than zero must be able to match this entry. ■ Any: Any value is allowed ("don't-care"). |
| <ul style="list-style-type: none"> • IP Fragment | <p>Specify the fragment offset settings for this ACE. This involves the settings for the More Fragments (MF) bit and the Fragment Offset (FRAG OFFSET) field for an IPv4 frame.</p> <ul style="list-style-type: none"> ■ No: IPv4 frames where the MF bit is set or the FRAG OFFSET field is greater than zero must not be able to match this entry. |

| | |
|--|---|
| | <ul style="list-style-type: none"> ■ Yes: IPv4 frames where the MF bit is set or the FRAG OFFSET field is greater than zero must be able to match this entry. ■ Any: Any value is allowed ("don't-care"). |
| <ul style="list-style-type: none"> • IP Option | <p>Specify the options flag setting for this ACE.</p> <ul style="list-style-type: none"> ■ No: IPv4 frames where the options flag is set must not be able to match this entry. ■ Yes: IPv4 frames where the options flag is set must be able to match this entry. ■ Any: Any value is allowed ("don't-care"). |
| <ul style="list-style-type: none"> • SIP Filter | <p>Specify the source IP filter for this ACE.</p> <ul style="list-style-type: none"> ■ Any: No source IP filter is specified. (Source IP filter is "don't-care".) ■ Host: Source IP filter is set to Host. Specify the source IP address in the SIP Address field that appears. ■ Network: Source IP filter is set to Network. Specify the source IP address and source IP mask in the SIP Address and SIP Mask fields that appear. |
| <ul style="list-style-type: none"> • SIP Address | <p>When "Host" or "Network" is selected for the source IP filter, you can enter a specific SIP address in dotted decimal notation.</p> |
| <ul style="list-style-type: none"> • SIP Mask | <p>When "Network" is selected for the source IP filter, you can enter a specific SIP mask in dotted decimal notation.</p> |
| <ul style="list-style-type: none"> • DIP Filter | <p>Specify the destination IP filter for this ACE.</p> <ul style="list-style-type: none"> ■ Any: No destination IP filter is specified. (Destination IP filter is "don't-care".) ■ Host: Destination IP filter is set to Host. Specify the destination IP address in the DIP Address field that appears. ■ Network: Destination IP filter is set to Network. Specify the destination IP address and destination IP mask in the DIP Address and DIP Mask fields that appear. |
| <ul style="list-style-type: none"> • DIP Address | <p>When "Host" or "Network" is selected for the destination IP filter, you can enter a specific DIP address in dotted decimal notation.</p> |
| <ul style="list-style-type: none"> • DIP Mask | <p>When "Network" is selected for the destination IP filter, you can enter a specific DIP mask in dotted decimal notation.</p> |

■ **IPv6 Parameters**

| Object | Description |
|---|---|
| <ul style="list-style-type: none"> • Next Header Filter | <p>Specify the IPv6 next header filter for this ACE.</p> <ul style="list-style-type: none"> ■ Any: No IPv6 next header filter is specified ("don't-care"). ■ Specific: If you want to filter a specific IPv6 next header filter with this ACE, choose this value. A field for entering an IPv6 next header filter |

| | |
|--|--|
| | <p>appears.</p> <ul style="list-style-type: none"> ■ ICMP: Select ICMP to filter IPv6 ICMP protocol frames. Extra fields for defining ICMP parameters will appear. These fields are explained later in this help file. ■ UDP: Select UDP to filter IPv6 UDP protocol frames. Extra fields for defining UDP parameters will appear. These fields are explained later in this help file. ■ TCP: Select TCP to filter IPv6 TCP protocol frames. Extra fields for defining TCP parameters will appear. These fields are explained later in this help file. |
| <ul style="list-style-type: none"> • Next Header Value | <p>When "Specific" is selected for the IPv6 next header value, you can enter a specific value. The allowed range is 0 to 255. A frame that hits this ACE matches this IPv6 protocol value.</p> |
| <ul style="list-style-type: none"> • SIP Filter | <p>Specify the source IPv6 filter for this ACE.</p> <ul style="list-style-type: none"> ■ Any: No source IPv6 filter is specified. (Source IPv6 filter is "don't-care".) ■ Specific: Source IPv6 filter is set to Network. Specify the source IPv6 address and source IPv6 mask in the SIP Address fields that appear. |
| <ul style="list-style-type: none"> • SIP Address | <p>When "Specific" is selected for the source IPv6 filter, you can enter a specific SIPv6 address. The field only supported last 32 bits for IPv6 address.</p> |
| <ul style="list-style-type: none"> • SIP BitMask | <p>When "Specific" is selected for the source IPv6 filter, you can enter a specific SIPv6 mask. The field only supported last 32 bits for IPv6 address. Notice the usage of bitmask, if the binary bit value is "0", it means this bit is "don't-care".</p> <p>The real matched pattern is [sipv6_address & sipv6_bitmask] (last 32 bits). For example, if the SIPv6 address is 2001::3 and the SIPv6 bitmask is 0xFFFFFFFF (bit 0 is "don't-care" bit), then SIPv6 address 2001::2 and 2001::3 are applied to this rule.</p> |
| <ul style="list-style-type: none"> • Hop Limit | <p>Specify the hop limit settings for this ACE.</p> <ul style="list-style-type: none"> ■ zero: IPv6 frames with a hop limit field greater than zero must not be able to match this entry. ■ non-zero: IPv6 frames with a hop limit field greater than zero must be able to match this entry. ■ Any: Any value is allowed ("don't-care"). |

■ **ICMP Parameters**

| Object | Description |
|---|--|
| <ul style="list-style-type: none"> • ICMP Type Filter | <p>Specify the ICMP filter for this ACE.</p> <ul style="list-style-type: none"> ■ Any: No ICMP filter is specified (ICMP filter status is "don't-care"). ■ Specific: If you want to filter a specific ICMP filter with this ACE, you can |

| | |
|---|---|
| | enter a specific ICMP value. A field for entering an ICMP value appears. |
| <ul style="list-style-type: none"> • ICMP Type Value | <p>When "Specific" is selected for the ICMP filter, you can enter a specific ICMP value.</p> <p>The allowed range is 0 to 255. A frame that hits this ACE matches this ICMP value.</p> |
| <ul style="list-style-type: none"> • ICMP Code Filter | <p>Specify the ICMP code filter for this ACE.</p> <ul style="list-style-type: none"> ■ Any: No ICMP code filter is specified (ICMP code filter status is "don't-care"). ■ Specific: If you want to filter a specific ICMP code filter with this ACE, you can enter a specific ICMP code value. A field for entering an ICMP code value appears. |
| <ul style="list-style-type: none"> • ICMP Code Value | <p>When "Specific" is selected for the ICMP code filter, you can enter a specific ICMP code value.</p> <p>The allowed range is 0 to 255. A frame that hits this ACE matches this ICMP code value.</p> |

■ **TCP/UDP Parameters**

| Object | Description |
|---|---|
| <ul style="list-style-type: none"> • TCP/UDP Source Filter | <p>Specify the TCP/UDP source filter for this ACE.</p> <ul style="list-style-type: none"> ■ Any: No TCP/UDP source filter is specified (TCP/UDP source filter status is "don't-care"). ■ Specific: If you want to filter a specific TCP/UDP source filter with this ACE, you can enter a specific TCP/UDP source value. A field for entering a TCP/UDP source value appears. ■ Range: If you want to filter a specific TCP/UDP source range filter with this ACE, you can enter a specific TCP/UDP source range value. A field for entering a TCP/UDP source value appears. |
| <ul style="list-style-type: none"> • TCP/UDP Source No. | <p>When "Specific" is selected for the TCP/UDP source filter, you can enter a specific TCP/UDP source value. The allowed range is 0 to 65535. A frame that hits this ACE matches this TCP/UDP source value.</p> |
| <ul style="list-style-type: none"> • TCP/UDP Source Range | <p>When "Range" is selected for the TCP/UDP source filter, you can enter a specific TCP/UDP source range value. The allowed range is 0 to 65535. A frame that hits this ACE matches this TCP/UDP source value.</p> |
| <ul style="list-style-type: none"> • TCP/UDP Destination Filter | <p>Specify the TCP/UDP destination filter for this ACE.</p> <ul style="list-style-type: none"> ■ Any: No TCP/UDP destination filter is specified (TCP/UDP destination filter status is "don't-care"). ■ Specific: If you want to filter a specific TCP/UDP destination filter with this ACE, you can enter a specific TCP/UDP destination value. A field for |

| | |
|---|--|
| | <p>entering a TCP/UDP destination value appears.</p> <ul style="list-style-type: none"> ■ Range: If you want to filter a specific range TCP/UDP destination filter with this ACE, you can enter a specific TCP/UDP destination range value. A field for entering a TCP/UDP destination value appears. |
| <ul style="list-style-type: none"> • TCP/UDP Destination Number | <p>When "Specific" is selected for the TCP/UDP destination filter, you can enter a specific TCP/UDP destination value. The allowed range is 0 to 65535. A frame that hits this ACE matches this TCP/UDP destination value.</p> |
| <ul style="list-style-type: none"> • TCP/UDP Destination Range | <p>When "Range" is selected for the TCP/UDP destination filter, you can enter a specific TCP/UDP destination range value. The allowed range is 0 to 65535. A frame that hits this ACE matches this TCP/UDP destination value.</p> |
| <ul style="list-style-type: none"> • TCP FIN | <p>Specify the TCP "No more data from sender" (FIN) value for this ACE.</p> <ul style="list-style-type: none"> ■ 0: TCP frames where the FIN field is set must not be able to match this entry. ■ 1: TCP frames where the FIN field is set must be able to match this entry. ■ Any: Any value is allowed ("don't-care"). |
| <ul style="list-style-type: none"> • TCP SYN | <p>Specify the TCP "Synchronize sequence numbers" (SYN) value for this ACE.</p> <ul style="list-style-type: none"> ■ 0: TCP frames where the SYN field is set must not be able to match this entry. ■ 1: TCP frames where the SYN field is set must be able to match this entry. ■ Any: Any value is allowed ("don't-care"). |
| <ul style="list-style-type: none"> • TCP RST | <p>Specify the TCP "Reset the connection" (RST) value for this ACE.</p> <ul style="list-style-type: none"> ■ 0: TCP frames where the RST field is set must not be able to match this entry. ■ 1: TCP frames where the RST field is set must be able to match this entry. ■ Any: Any value is allowed ("don't-care"). |
| <ul style="list-style-type: none"> • TCP PSH | <p>Specify the TCP "Push Function" (PSH) value for this ACE.</p> <ul style="list-style-type: none"> ■ 0: TCP frames where the PSH field is set must not be able to match this entry. ■ 1: TCP frames where the PSH field is set must be able to match this entry. ■ Any: Any value is allowed ("don't-care"). |
| <ul style="list-style-type: none"> • TCP ACK | <p>Specify the TCP "Acknowledgment field significant" (ACK) value for this ACE.</p> <ul style="list-style-type: none"> ■ 0: TCP frames where the ACK field is set must not be able to match this entry. ■ 1: TCP frames where the ACK field is set must be able to match this entry. ■ Any: Any value is allowed ("don't-care"). |
| <ul style="list-style-type: none"> • TCP URG | <p>Specify the TCP "Urgent Pointer field significant" (URG) value for this ACE.</p> <ul style="list-style-type: none"> ■ 0: TCP frames where the URG field is set must not be able to match this entry. ■ 1: TCP frames where the URG field is set must be able to match this entry. |

| | |
|--|--|
| | <ul style="list-style-type: none"> ■ Any: Any value is allowed ("don't-care"). |
|--|--|

■ **Ethernet Type Parameters**

The Ethernet Type parameters can be configured when Frame Type "Ethernet Type" is selected.

| Object | Description |
|--|--|
| <ul style="list-style-type: none"> • EtherType Filter | <p>Specify the Ethernet type filter for this ACE.</p> <ul style="list-style-type: none"> ■ Any: No EtherType filter is specified (EtherType filter status is "don't-care"). ■ Specific: If you want to filter a specific EtherType filter with this ACE, you can enter a specific EtherType value. A field for entering a EtherType value appears. |
| <ul style="list-style-type: none"> • Ethernet Type Value | <p>When "Specific" is selected for the EtherType filter, you can enter a specific EtherType value.</p> <p>The allowed range is 0x600 to 0xFFFF but excluding 0x800(IPv4), 0x806(ARP) and 0x86DD(IPv6). A frame that hits this ACE matches this EtherType value.</p> |

Buttons

: Click to apply changes

: Click to undo any changes made locally and revert to previously saved values.

: Return to the previous page.

4.5.5.4 ACL Ports Configuration

Configure the ACL parameters (ACE) of each switch port. These parameters will affect frames received on a port unless the frame matches a specific ACE. The ACL Ports Configuration screen in [Figure 4-5-5-4](#) appears.

ACL Ports Configuration

| Port | Policy ID | Action | Rate Limiter ID | Port Redirect | Mirror | Logging | Shutdown | State | Counter |
|------|-----------|----------|-----------------|---------------|------------|------------|------------|-----------|---------|
| * | 0 | <All> ▼ | <All> ▼ | <All> ▼ | <All> ▼ | <All> ▼ | <All> ▼ | <All> ▼ | * |
| 1 | 0 | Permit ▼ | Disabled ▼ | Disabled ▼ | Disabled ▼ | Disabled ▼ | Disabled ▼ | Enabled ▼ | 0 |
| 2 | 0 | Permit ▼ | Disabled ▼ | Disabled ▼ | Disabled ▼ | Disabled ▼ | Disabled ▼ | Enabled ▼ | 18006 |
| 3 | 0 | Permit ▼ | Disabled ▼ | Disabled ▼ | Disabled ▼ | Disabled ▼ | Disabled ▼ | Enabled ▼ | 0 |
| 4 | 0 | Permit ▼ | Disabled ▼ | Disabled ▼ | Disabled ▼ | Disabled ▼ | Disabled ▼ | Enabled ▼ | 0 |
| 5 | 0 | Permit ▼ | Disabled ▼ | Disabled ▼ | Disabled ▼ | Disabled ▼ | Disabled ▼ | Enabled ▼ | 0 |
| 6 | 0 | Permit ▼ | Disabled ▼ | Disabled ▼ | Disabled ▼ | Disabled ▼ | Disabled ▼ | Enabled ▼ | 0 |
| 7 | 0 | Permit ▼ | Disabled ▼ | Disabled ▼ | Disabled ▼ | Disabled ▼ | Disabled ▼ | Enabled ▼ | 0 |
| 8 | 0 | Permit ▼ | Disabled ▼ | Disabled ▼ | Disabled ▼ | Disabled ▼ | Disabled ▼ | Enabled ▼ | 0 |
| 9 | 0 | Permit ▼ | Disabled ▼ | Disabled ▼ | Disabled ▼ | Disabled ▼ | Disabled ▼ | Enabled ▼ | 0 |
| 10 | 0 | Permit ▼ | Disabled ▼ | Disabled ▼ | Disabled ▼ | Disabled ▼ | Disabled ▼ | Enabled ▼ | 0 |

Figure 4-5-5-4: ACL Ports Configuration Page Screenshot

The page includes the following fields:

| Object | Description |
|--------------------------|--|
| • Port | The logical port for the settings contained in the same row. |
| • Policy ID | Select the policy to apply to this port. The allowed values are 0 through 255 . The default value is 0. |
| • Action | Select whether forwarding is permitted ("Permit") or denied ("Deny"). The default value is "Permit". |
| • Rate Limiter ID | Select which rate limiter to apply on this port. The allowed values are Disabled or the values 1 through 16 . The default value is "Disabled". |
| • Port Redirect | Select which port frames are redirected on. The allowed values are Disabled or a specific port number and it can't be set when action is permitted. The default value is "Disabled". |
| • Mirror | Specify the mirror operation of this port. The allowed values are: Enabled : Frames received on the port are mirrored. Disabled : Frames received on the port are not mirrored. The default value is "Disabled". |
| • Logging | Specify the logging operation of this port. The allowed values are: ■ Enabled : Frames received on the port are stored in the System Log. ■ Disabled : Frames received on the port are not logged. The default value is "Disabled". <i>Please note that the System Log memory size and logging rate are limited.</i> |
| • Shutdown | Specify the port shut down operation of this port. The allowed values are: ■ Enabled : If a frame is received on the port, the port will be disabled. |

| | |
|--|---|
| | <ul style="list-style-type: none"> ■ Disabled: Port shut down is disabled. The default value is "Disabled". |
| <ul style="list-style-type: none"> • State | <p>Specify the port state of this port. The allowed values are:</p> <ul style="list-style-type: none"> ■ Enabled: To reopen ports by changing the volatile port configuration of the ACL user module. ■ Disabled: To close ports by changing the volatile port configuration of the ACL user module. <p>The default value is "Enabled".</p> |
| <ul style="list-style-type: none"> • Counter | <p>Counts the number of frames that match this ACE.</p> |

Buttons

: Click to apply changes

: Click to undo any changes made locally and revert to previously saved values.

: Click to refresh the page; any changes made locally will be undone.

: Click to clear the counters.

4.5.5.5 ACL Rate Limiters

Configure the rate limiter for the ACL of the switch.

The ACL Rate Limiter Configuration screen in [Figure 4-5-5-5](#) appears.

ACL Rate Limiter Configuration

| Rate Limiter ID | Rate | Unit |
|-----------------|------|---------|
| * | 10 | <All> ▼ |
| 1 | 10 | pps ▼ |
| 2 | 10 | pps ▼ |
| 3 | 10 | pps ▼ |
| 4 | 10 | pps ▼ |
| 5 | 10 | pps ▼ |
| 6 | 10 | pps ▼ |
| 7 | 10 | pps ▼ |
| 8 | 10 | pps ▼ |
| 9 | 10 | pps ▼ |
| 10 | 10 | pps ▼ |
| 11 | 10 | pps ▼ |
| 12 | 10 | pps ▼ |
| 13 | 10 | pps ▼ |
| 14 | 10 | pps ▼ |
| 15 | 10 | pps ▼ |
| 16 | 10 | pps ▼ |

Figure 4-5-5-5: ACL Rate Limiter Configuration Page Screenshot

The page includes the following fields:

| Object | Description |
|--------------------------|---|
| • Rate Limiter ID | The rate limiter ID for the settings contained in the same row. |
| • Rate (pps) | The allowed values are: 0-3276700 in pps or 0, 100, 200, 300, ..., 1000000 in kbps. |
| • Unit | Specify the rate unit. The allowed values are: pps : packets per second. kbps : Kbits per second. |

Buttons

: Click to apply changes

: Click to undo any changes made locally and revert to previously saved values.

4.5.6 DHCP Snooping

DHCP Snooping is used to block intruder on the untrusted ports of DUT when it tries to intervene by injecting a bogus DHCP reply packet to a legitimate conversation between the DHCP client and server.

DHCP Snooping Overview

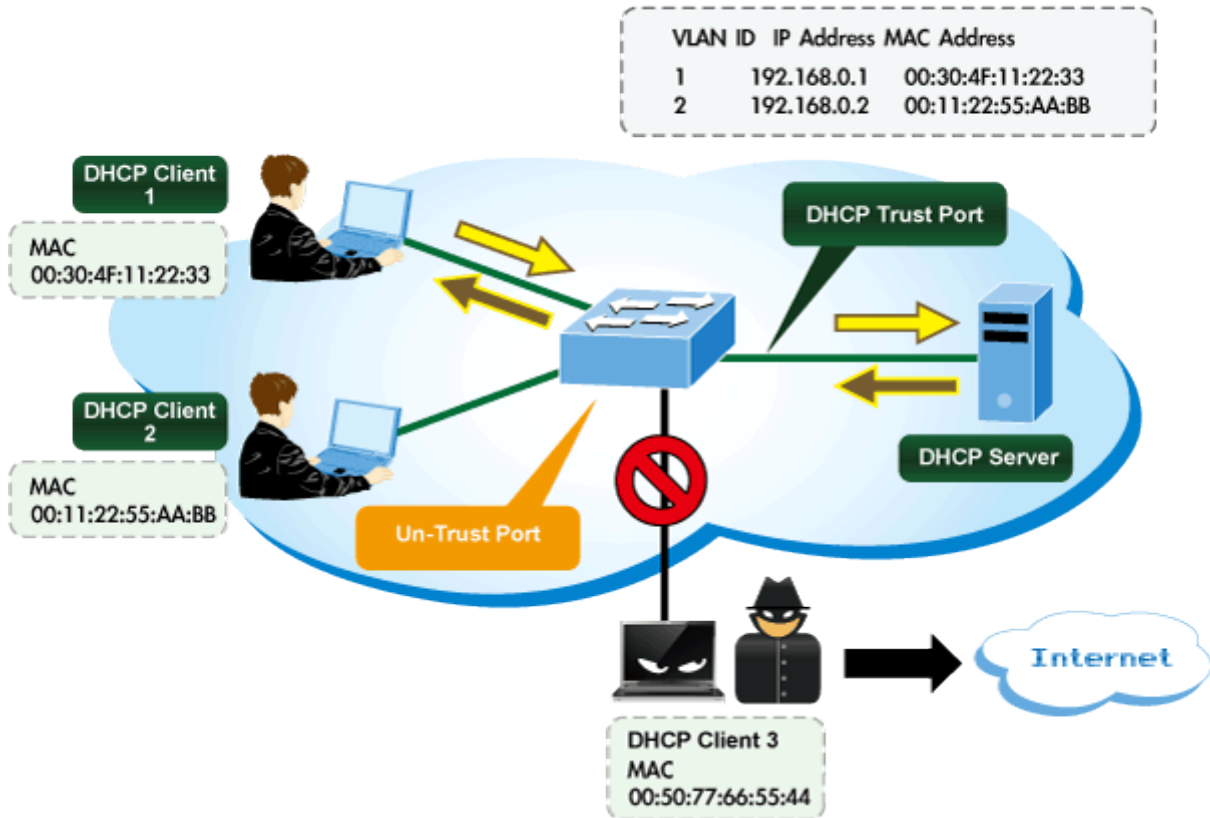

4.5.6.1 DHCP Snooping Configuration

Configure DHCP Snooping on this page. in [Figure 4-5-6-1](#) appears.

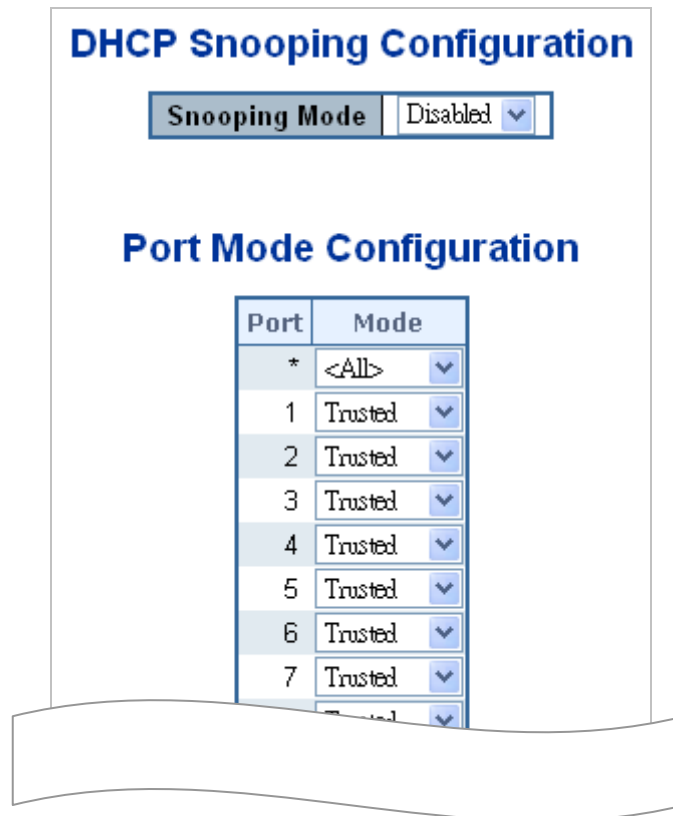



Figure 4-5-6-1: DHCP Snooping Configuration Screen Page Screenshot

The page includes the following fields:

| Object | Description |
|--|---|
| <ul style="list-style-type: none"> Snooping Mode | <p>Indicates the DHCP snooping mode operation. Possible modes are:</p> <ul style="list-style-type: none"> ■ Enabled: Enable DHCP snooping mode operation. When enable DHCP snooping mode operation, the request DHCP messages will be forwarded to trusted ports and only allowed reply packets from trusted ports. ■ Disabled: Disable DHCP snooping mode operation. |
| <ul style="list-style-type: none"> Port Mode Configuration | <p>Indicates the DHCP snooping port mode. Possible port modes are:</p> <ul style="list-style-type: none"> ■ Trusted: Configures the port as trusted sources of the DHCP message. ■ Untrusted: Configures the port as untrusted sources of the DHCP message. |

Buttons

 : Click to apply changes

 : Click to undo any changes made locally and revert to previously saved values.

4.5.6.2 Snooping Table

This page displays the dynamic IP assigned information after DHCP Snooping mode is disabled. All DHCP clients obtained the dynamic IP address from the DHCP server will be listed in this table except for local VLAN interface IP addresses. Entries in the Dynamic DHCP snooping Table are shown on this page. The Dynamic DHCP Snooping Table screen in [Figure 4-5-6-2](#) appears.

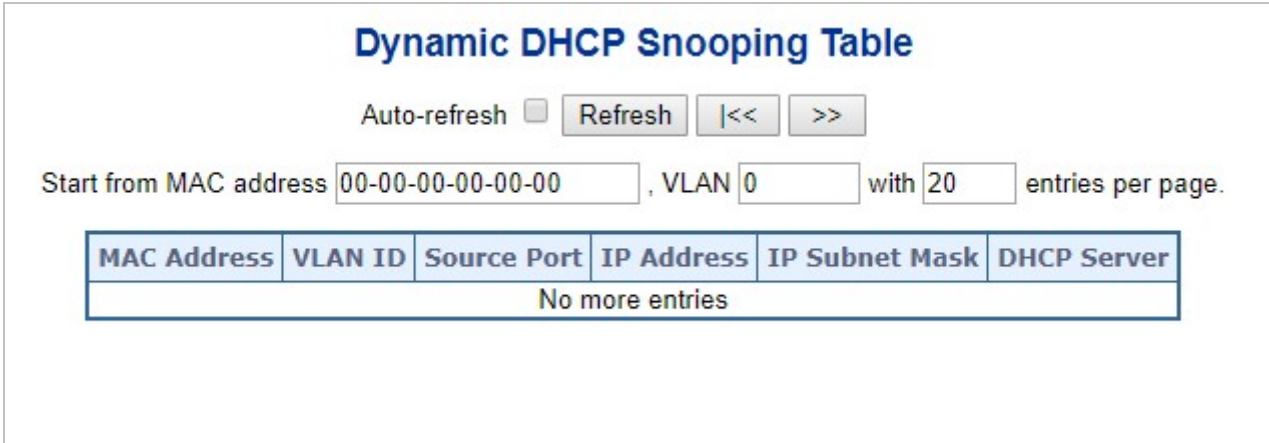

Figure 4-5-6-2: Dynamic DHCP Snooping Table Screen Page Screenshot

| Object | Description |
|------------------------------|---|
| • MAC Address | User MAC address of the entry. |
| • VLAN ID | VLAN-ID in which the DHCP traffic is permitted. |
| • Source Port | Switch Port Number for which the entries are displayed. |
| • IP Address | User IP address of the entry. |
| • IP Subnet Mask | User IP subnet mask of the entry. |
| • DHCP Server Address | DHCP Server address of the entry. |

Buttons

Auto-refresh : Check this box to refresh the page automatically. Automatic refresh occurs every 3 seconds.

Refresh: Refreshes the displayed table starting from the input fields

Clear: Flushes all dynamic entries.

>>: It will use the last entry of the currently displayed table as a basis for the next lookup. When the end is reached the text "No more entries" is shown in the displayed table

|<<: To start over

4.5.7 IP Source Guard

4.5.7.1 IP Source Guard Configuration

IP Source Guard is a secure feature used to restrict IP traffic on **DHCP snooping untrusted ports** by filtering traffic based on the DHCP Snooping Table or manually configured IP Source Bindings. It helps prevent IP spoofing attacks when a host tries to spoof and use the IP address of another host. This page provides IP Source Guard related configuration. The IP Source Guard Configuration screen in [Figure 4-5-7-1](#) appears.

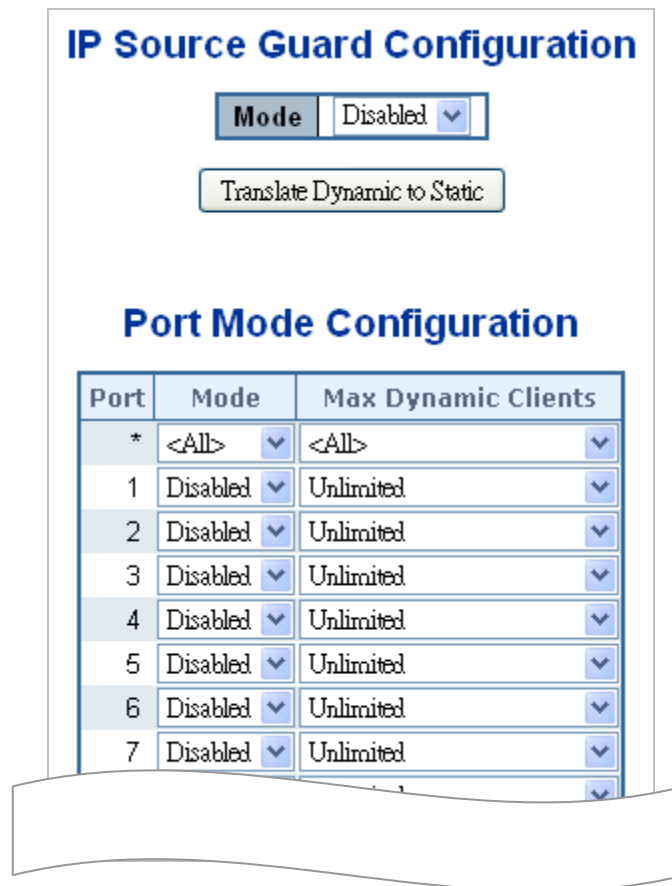

Figure 4-5-7-1: IP Source Guard Configuration Screen Page Screenshot

The page includes the following fields:

| Object | Description |
|--|---|
| <ul style="list-style-type: none"> • Mode of IP Source Guard Configuration | Enable the Global IP Source Guard or disable the Global IP Source Guard. All configured ACEs will be lost when the mode is enabled. |
| <ul style="list-style-type: none"> • Port Mode Configuration | Specify IP Source Guard is enabled on which ports. Only when both Global Mode and Port Mode on a given port are enabled, IP Source Guard is enabled on this given port. |
| <ul style="list-style-type: none"> • Max Dynamic Clients | Specify the maximum number of dynamic clients can be learned on given ports. This value can be 0, 1, 2 and unlimited. If the port mode is enabled and the value |

| | |
|--|--|
| | of max dynamic client is equal 0, it means only allow the IP packets forwarding that are matched in static entries on the specific port. |
|--|--|

Buttons

Translate Dynamic to Static: Click to translate all dynamic entries to static entries.

Apply: Click to apply changes

Reset: Click to undo any changes made locally and revert to previously saved values.

4.5.7.2 Static IP Source Guard Table

This page provides Static IP Source Guard Table. The Static IP Source Guard Table screen in [Figure 4-5-7-2](#) appears.

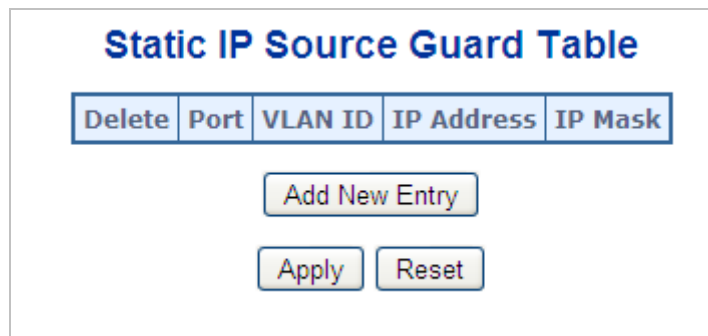

Figure 4-5-7-2: Static IP Source Guard Table Screen Page Screenshot

The page includes the following fields:

| Object | Description |
|----------------------|---|
| • Delete | Check to delete the entry. It will be deleted during the next save. |
| • Port | The logical port for the settings. |
| • VLAN ID | The VLAN ID for the settings. |
| • IP Address | Allowed Source IP address. |
| • MAC Address | Allowed Source MAC address. |

Buttons

Add New Entry: Click to add a new entry to the Static IP Source Guard table.

Apply: Click to apply changes

Reset: Click to undo any changes made locally and revert to previously saved values.

4.5.7.3 Dynamic IP Source Guard Table

This page provides Static IP Source Guard Table. The Static IP Source Guard Table screen in [Figure 4-5-7-3](#) appears.

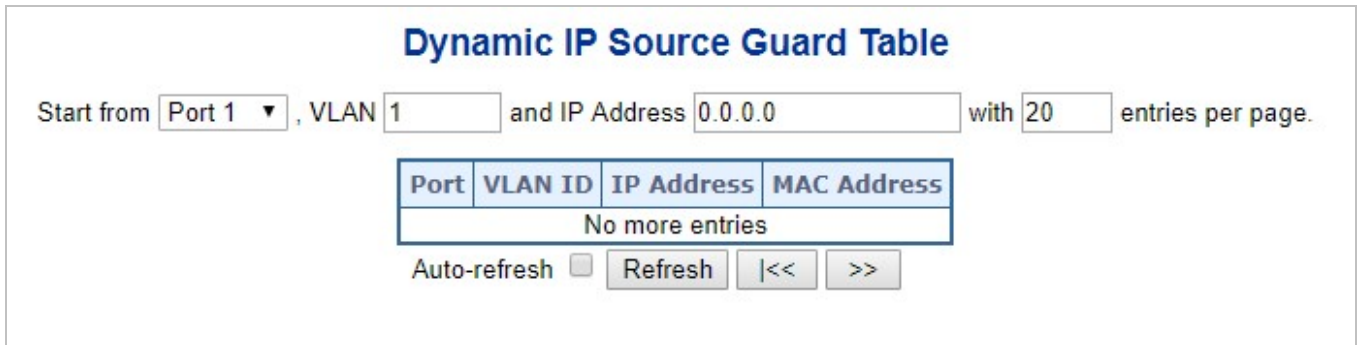

Figure 4-5-7-3: Static IP Source Guard Table Screen Page Screenshot

The page includes the following fields:

| Object | Description |
|---------------|---|
| • Port | Switch Port Number for which the entries are displayed. |
| • VLAN ID | VLAN-ID in which the IP traffic is permitted. |
| • IP Address | User IP address of the entry. |
| • MAC Address | Source MAC address. |

Buttons

Auto-refresh : Check this box to refresh the page automatically. Automatic refresh occurs every 3 seconds

Refresh : Refreshes the displayed table starting from the input fields..

Clear : Flushes all dynamic entries.

>> : Updates the table starting from the first entry in the Dynamic IP Source Guard Table.

|<< : Updates the table, starting with the entry after the last entry currently displayed.

4.5.8 ARP Inspection

4.5.8.1 ARP Inspection

ARP Inspection is a secure feature. Several types of attacks can be launched against a host or devices connected to Layer 2 networks by "poisoning" the ARP caches. This feature is used to block such attacks. Only valid ARP requests and responses can go through DUT. This page provides ARP Inspection related configuration. The ARP Inspection Configuration screen in Figure 4-5-8-1 appears.

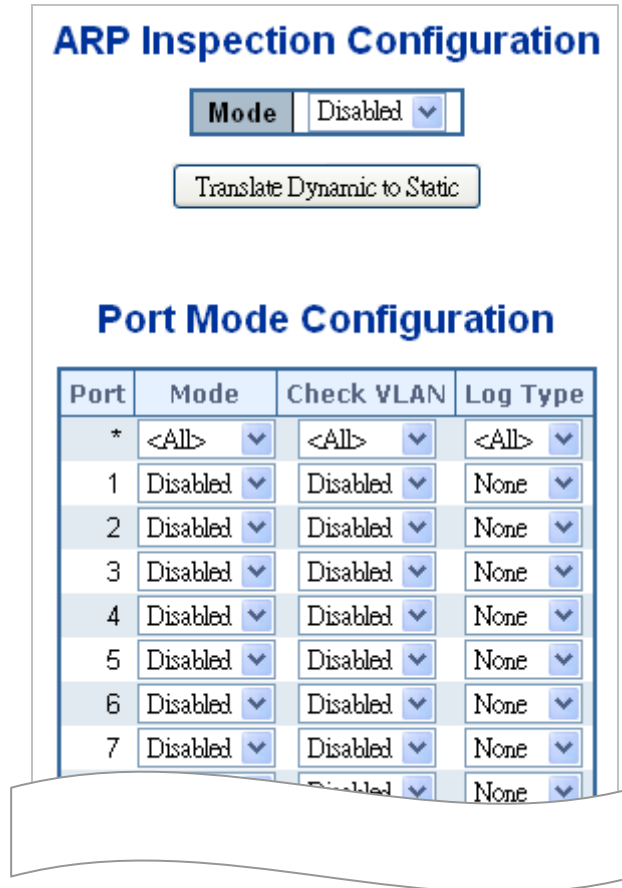

Figure 4-5-8-1: ARP Inspection Configuration Screen Page Screenshot

The page includes the following fields:

| Object | Description |
|---|---|
| <ul style="list-style-type: none"> • Mode of ARP Inspection Configuration | Enable the Global ARP Inspection or disable the Global ARP Inspection. |
| <ul style="list-style-type: none"> • Port Mode Configuration | Specify ARP Inspection is enabled on which ports. Only when both Global Mode and Port Mode on a given port are enabled, ARP Inspection is enabled on this given port. Possible modes are: <ul style="list-style-type: none"> ■ Enabled: Enable ARP Inspection operation. |

- **Disabled**: Disable ARP Inspection operation.

If you want to inspect the VLAN configuration, you have to enable the setting of "**Check VLAN**". The default setting of "Check VLAN" is disabled. When the setting of "Check VLAN" is disabled, the log type of ARP Inspection will refer to the port setting. And the setting of "Check VLAN" is enabled, the log type of ARP Inspection will refer to the VLAN setting. Possible setting of "**Check VLAN**" are:

- **Enabled**: Enable check VLAN operation.
- **Disabled**: Disable check VLAN operation.

Only the Global Mode and Port Mode on a given port are enabled, and the setting of "Check VLAN" is disabled, the log type of ARP Inspection will refer to the port setting. There are four **log types** and possible types are:

- **None**: Log nothing.
- **Deny**: Log denied entries.
- **Permit**: Log permitted entries.
- **ALL**: Log all entries.

Buttons

Translate Dynamic to Static: Click to translate all dynamic entries to static entries.

Apply: Click to apply changes

Reset: Click to undo any changes made locally and revert to previously saved values.

4.5.8.2 ARP Inspection Static Table

This page provides Static ARP Inspection Table. The Static ARP Inspection Table screen in [Figure 4-5-8-2](#) appears.

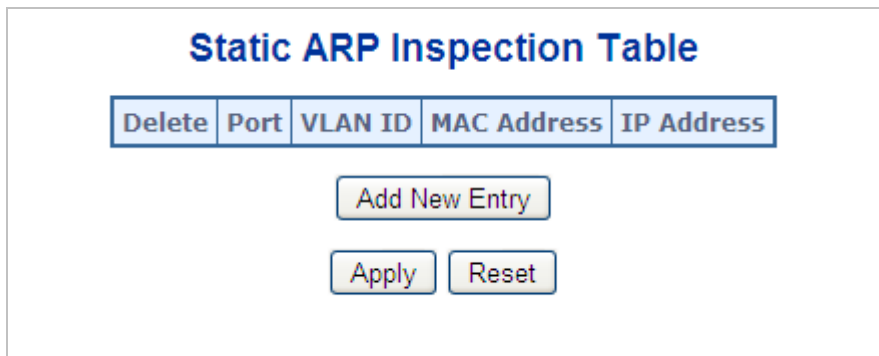

Figure 4-5-8-2: Static ARP Inspection Table Screen Page Screenshot

The page includes the following fields:

| Object | Description |
|----------------------|---|
| • Delete | Check to delete the entry. It will be deleted during the next save. |
| • Port | The logical port for the settings. |
| • VLAN ID | The VLAN ID for the settings. |
| • MAC Address | Allowed Source MAC address in ARP request packets. |
| • IP Address | Allowed Source IP address in ARP request packets. |

Buttons

Add New Entry: Click to add a new entry to the Static ARP Inspection table.

Apply: Click to apply changes

Reset: Click to undo any changes made locally and revert to previously saved values.

4.5.8.3 Dynamic ARP Inspection Table

Entries in the Dynamic ARP Inspection Table are shown on this page. The Dynamic ARP Inspection Table contains up to 1024 entries, and is sorted first by port, then by VLAN ID, then by MAC address, and then by IP address. The Dynamic ARP Inspection Table screen in [Figure 5-8-3](#) appears.

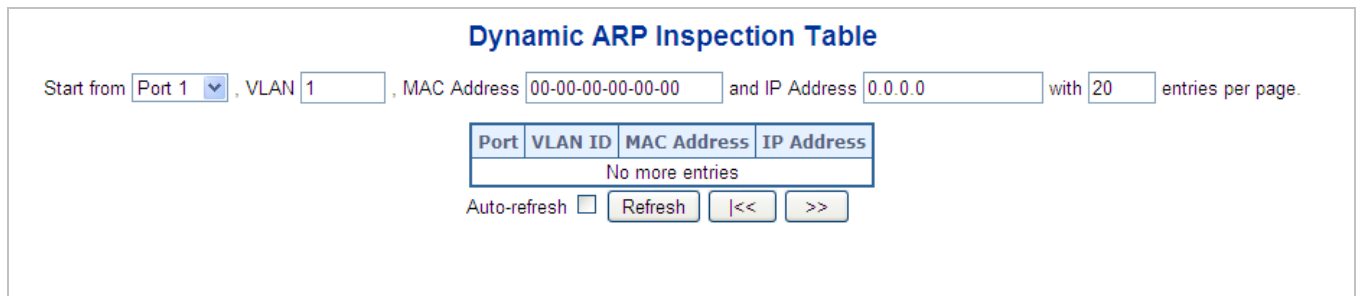

Figure 5-8-3: Dynamic ARP Inspection Table Screenshot

Navigating the ARP Inspection Table

Each page shows up to 99 entries from the Dynamic ARP Inspection table, default being 20, selected through the "**entries per Page**" input field. When first visited, the web page will show the first 20 entries from the beginning of the Dynamic ARP Inspection Table.

The "**Start from port address**", "**VLAN**", "**MAC address**" and "**IP address**" input fields allow the user to select the starting point in the Dynamic ARP Inspection Table. Clicking the "**Refresh**" button will update the displayed table starting from that or the closest next Dynamic ARP Inspection Table match. In addition, the two input fields will - upon a "**Refresh**" button click - assume the value of the first displayed entry, allowing for continuous refresh with the same start address.

The ">" will use the last entry of the currently displayed as a basis for the next lookup. When the end is reached the text "No more entries" is shown in the displayed table. Use the "<<" button to start over. The page includes the following fields:

| Object | Description |
|----------------------|---|
| • Port | The port number for which the status applies. Click the port number to see the status for this particular port. |
| • VLAN ID | The VLAN ID of the entry. |
| • MAC Address | The MAC address of the entry. |
| • IP Address | The IP address of the entry. |

Buttons

Auto-refresh : Check this box to refresh the page automatically. Automatic refresh occurs every 3 seconds.

: Refreshes the displayed table starting from the "Start from MAC address" and "VLAN" input fields.

: Flushes all dynamic entries.

: Updates the table starting from the first entry in the MAC Table, i.e. the entry with the lowest VLAN ID and MAC address.

: Updates the table, starting with the entry after the last entry currently displayed.

4.6 Power over Ethernet

4.6.1 PoE

Providing up to 4/8 PoE, in-line power interfaces, the IGS-5225-4UP1T2S/IGS-5225-8P2T2S PoE Switch can easily build a power central-controlled IP phone system, IP Camera system, AP group for the enterprise. For instance, 4/8 cameras/APs can be easily installed around the corners of the company for surveillance demands or a wireless roaming environment in the office can be built. Without the power-socket limitation, the IGS-5225-4UP1T2S/IGS-5225-8P2T2S PoE Switch makes the installation of cameras or WLAN AP easier and more efficient.

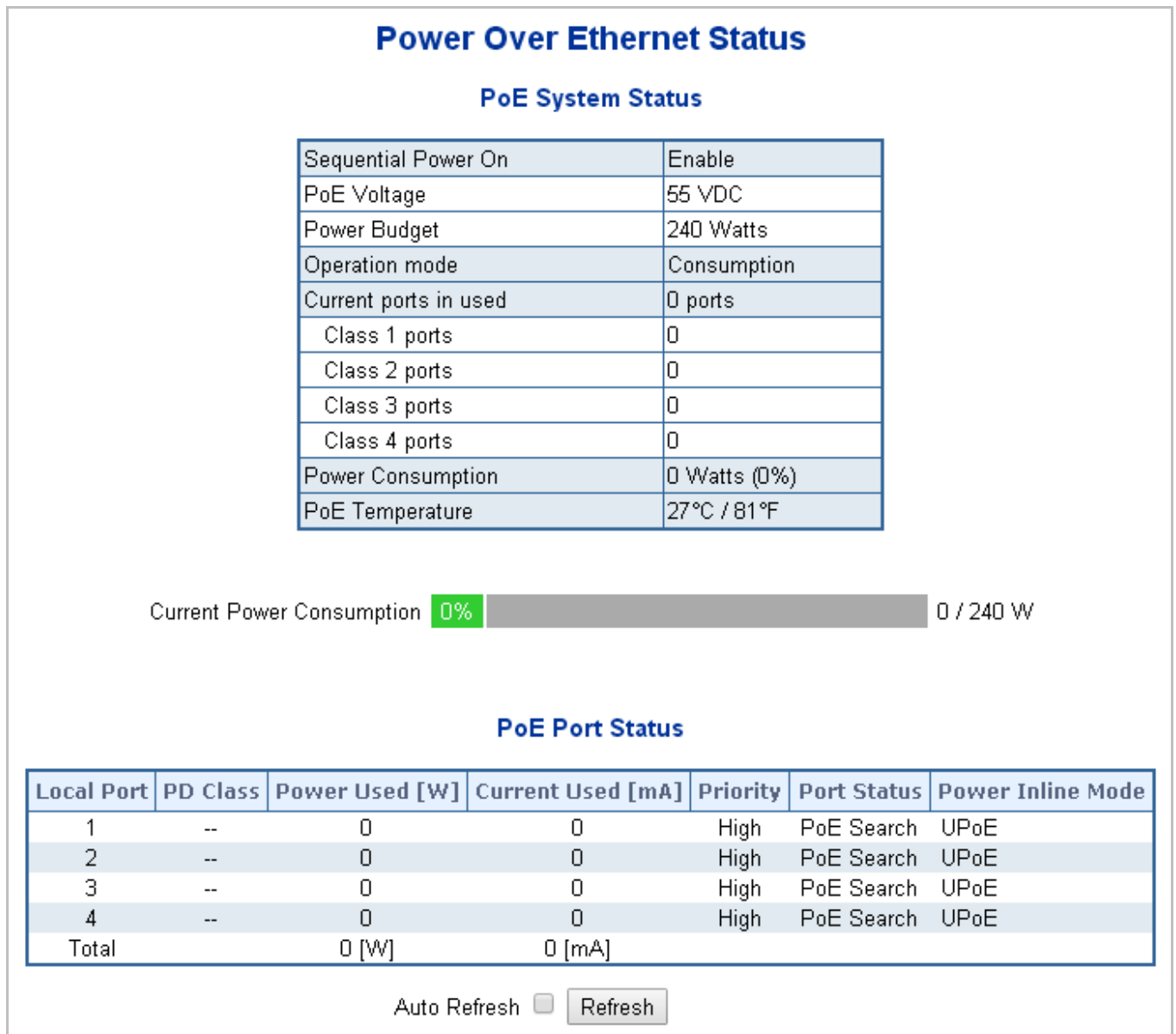







Figure 4-6-1-1: Power over Ethernet Status

4.6.1.1 Power over Ethernet Powered Device

| | |
|---|--|
|  <p>3~5 watts</p> | <p>Voice over IP phones</p> <p>Enterprises can install PoE VoIP phones, ATA and other Ethernet/non-Ethernet end-devices in the center where UPS is installed for un-interruptible power system and power control system.</p> |
|  <p>6~12 watts</p> | <p>Wireless LAN Access Points</p> <p>Access points can be installed at museums, sightseeing sites, airports, hotels, campuses, factories, warehouses, etc.</p> |
|  <p>10~12 watts</p> | <p>IP Surveillance</p> <p>IP cameras can be installed at enterprises, museums, campuses, hospitals, banks, etc. without worrying about electrical outlets.</p> |
|  <p>3~12 watts</p> | <p>PoE Splitter</p> <p>PoE Splitter split the PoE 56V DC over the Ethernet cable into 5/12V DC power output. It frees the device deployment from restrictions due to power outlet locations, which eliminate the costs for additional AC wiring and reduces the installation time.</p> |
|  <p>3~25 watts</p> | <p>High Power PoE Splitter</p> <p>High PoE Splitter split the PoE 56V DC over the Ethernet cable into 24/12V DC power output. It frees the device deployment from restrictions due to power outlet locations, which eliminate the costs for additional AC wiring and reduces the installation time.</p> |
|  <p>30~60 watts</p> | <p>High Power Speed Dome</p> <p>Its state-of-the-art design fits in various network environments like traffic centers, shopping malls, railway stations, warehouses, airports and production facilities for the most demanding outdoor surveillance applications. No electricians are needed to install AC sockets.</p> |

4.6.1.2 System Configuration

In a power over Ethernet system, operating power is applied from a power source (PSU or -power supply unit) over the LAN infrastructure to **powered devices (PDs)**, which are connected to ports. Under some conditions, the total output power required by PDs can exceed the maximum available power provided by the PSU. The system may come with a PSU capable of supplying less power than the total potential power consumption of all the PoE ports in the system. In order to maintain the activity of the majority of ports, power management is implemented.

The PSU input power consumption is monitored by measuring voltage and current .The input power consumption is equal to the system's aggregated power consumption .The power management concept allows all ports to be active and activates additional ports, as long as the aggregated power of the system is lower than the power level at which additional PDs cannot be connected .When this value is exceeded, ports will be deactivated, according to user-defined priorities. The power budget is managed according to the following user-definable parameters: maximum available power, ports priority, maximum allowable power per port.

Reserved Power determined by

There are five modes for configuring how the ports/PDs may reserve power and when to shut down ports.

■ **Classification mode**

In this mode each port automatically determines how much power to reserve according to the class the connected PD belongs to, and reserves the power accordingly. Four different port classes exist and one for 4, 7, 15.4 and 30.8 watts.

| Class | Usage | Range of maximum power used by the PD | Class Description |
|-------|----------|--|----------------------------|
| 0 | Default | 0.44 to 12.95 watts | Classification unimplement |
| 1 | Optional | 0.44 to 3.84 watts | Very low power |
| 2 | Optional | 3.84 to 6.49 watts | Low power |
| 3 | Optional | 6.49 to 12.95 watts (or to 15.4 watts) | Mid power |
| 4 | Optional | 12.95 to 60 watts (or to 72 watts) | High power |

■ **Allocation mode**

In this mode the user allocates the amount of power that each port may reserve. The allocated/reserved power for each port/PD is specified in the Maximum Power fields. The ports are shut down when total reserved powered exceeds the amount of power that the power supply can deliver.



In this mode the port power will not be turned on if the PD requests more available power.

■ **LLDP mode**

In this mode the ports of PoE power are managed and determined by LLDP Media Protocol.

4.6.1.3 Power over Ethernet Configuration

This section allows the user to inspect and configure the current PoE configuration settings, as [Figure 4-6-1-2](#) appears.

Power Over Ethernet Configuration

| | |
|-----------------------------------|--------------------------|
| System PoE Admin Mode | Enable ▼ |
| PoE Temperature Protection | Enable ▼ |
| PoE Management Mode | allocation-consumption ▼ |
| PoE Legacy Mode | Disable ▼ |
| Power Supply Budget[W] | 240 |
| Temperature Threshold | 70 Degrees C |
| PoE Usage Threshold | 85 % |

When selecting different PoE management modes refer to the user manual for proper operation.

Figure 4-6-1-2: PoE Configuration Screenshot

The page includes the following fields:

| Object | Description |
|---|--|
| <ul style="list-style-type: none"> • System PoE Admin Mode | Allows user to enable or disable PoE function. It will causes all of PoE ports to supply or not supply power. |
| <ul style="list-style-type: none"> • PoE Temperature Protection | Allows user to enable or disable PoE Temperature Protection. |
| <ul style="list-style-type: none"> • PoE Management Mode | <p>There are Six modes for configuring how the ports/PDs may reserve power and when to shut down ports.</p> <ul style="list-style-type: none"> ■ Class-Consumption mode: System offers PoE power according to PD real power consumption. ■ Class-Reserved-Power mode: System reserves PoE power to PD according to PoE class level. ■ Allocation-Consumption mode: System offers PoE power according to PD real power consumption. ■ Allocation-Reserved-Power mode: Users are allowed to assign how much PoE power for each port and system will reserve PoE power to PD. ■ LLDP-Consumption mode: System offers PoE power according to PD real power consumption. ■ LLDP-Reserved-Power mode: System reserves PoE power to PD according to LLDP configuration. |
| <ul style="list-style-type: none"> • PoE Legacy Mode | A port is powered using high-inrush current, which is used by legacy PDs with a power . |

| | |
|--|--|
| <ul style="list-style-type: none"> • Power Supply Budget [W] | Set limit value of the total PoE port providing power to the PDs. |
| <ul style="list-style-type: none"> • Temperature Threshold | Allows setting over temperature protection threshold value. If its system temperature is over the threshold then system will lower total PoE power budget automatically. |
| <ul style="list-style-type: none"> • PoE Usage Threshold | Allows setting how much PoE power budget could be limited. |

Buttons



: Click to apply changes



: Click to undo any changes made locally and revert to previously saved values.



The wire gauge for the terminal block should be in the range of 12 ~ 22 AWG@25 degrees C.

PD Classifications

A PD may be classified by the PSE based on the classification information provided by the PD. The intent of PD classification is to provide information about the maximum power required by the PD during operation. However, to improve power management at the PSE, the PD provides a signature about **Class level**.

The PD is classified based on power. The classification of the PD is the maximum power that the PD will draw across all input voltages and operational modes.

A PD will return to Class 0 to 4 in accordance with the maximum power draw as specified by [Table 4-6-1-1](#).

| Class | Usage | Range of maximum power used by the PD | Class Description |
|-------|----------|--|----------------------------|
| 0 | Default | 0.44 to 12.95 watts | Classification unimplement |
| 1 | Optional | 0.44 to 3.84 watts | Very low power |
| 2 | Optional | 3.84 to 6.49 watts | Low power |
| 3 | Optional | 6.49 to 12.95 watts (or to 15.4 watts) | Mid power |
| 4 | Optional | 12.95 to 60 watts (or to 72 watts) | High power |

Table 4-6-1-1 Device Class.

4.6.1.4 Port Configuration

This section allows the user to inspect and configure the current PoE port settings as [Figure 4-6-1-3](#) shows.

| Power Over Ethernet Configuration | | | | |
|-----------------------------------|----------|-------------|----------|---------------------|
| Port | PoE Mode | Schedule | Priority | Power Allocation[W] |
| * | <All> ▼ | <All> ▼ | <All> ▼ | 0 |
| 1 | Enable ▼ | Profile 1 ▼ | High ▼ | 0 |
| 2 | Enable ▼ | Profile 1 ▼ | High ▼ | 0 |
| 3 | Enable ▼ | Profile 1 ▼ | High ▼ | 0 |

Figure 4-6-1-3: Power over Ethernet Configuration Screenshot

The page includes the following fields:

| Object | Description |
|---|---|
| <ul style="list-style-type: none"> • PoE Mode | <p>There are three modes for PoE mode.</p> <ul style="list-style-type: none"> ■ Enable: enable PoE function.. ■ Disable: disable PoE function. ■ Schedule: enable PoE function in schedule mode. |
| <ul style="list-style-type: none"> • Schedule | <p>Indicates the schedule profile mode. Possible profiles are:</p> <ul style="list-style-type: none"> ■ Profile1 ■ Profile2 ■ Profile3 ■ Profile4 |
| <ul style="list-style-type: none"> • Priority | <p>The Priority represents PoE ports priority. There are three levels of power priority named Low, High and Critical.</p> <p>The priority is used in case the total power consumption is over the total power budget. In this case, the port with the lowest priority will be turned off, and power for the port of higher priority will be offered.</p> |
| <ul style="list-style-type: none"> • Power Allocation | <p>It can limit the port PoE supply wattage. Per port maximum value must be less than 36W watts; total ports values must be less than the Power Reservation value. Once power overload is detected, the port will automatically shut down and continue to be in detection mode until Pad's power consumption is lower than the power limit value.</p> |

Buttons

: Click to apply changes

: Click to undo any changes made locally and revert to previously saved values.

4.6.1.5 PoE Status

This page allows the user to inspect the total power consumption, total power reserved and current status for all PoE ports. The screen in [Figure 4-6-1-4](#) appears.

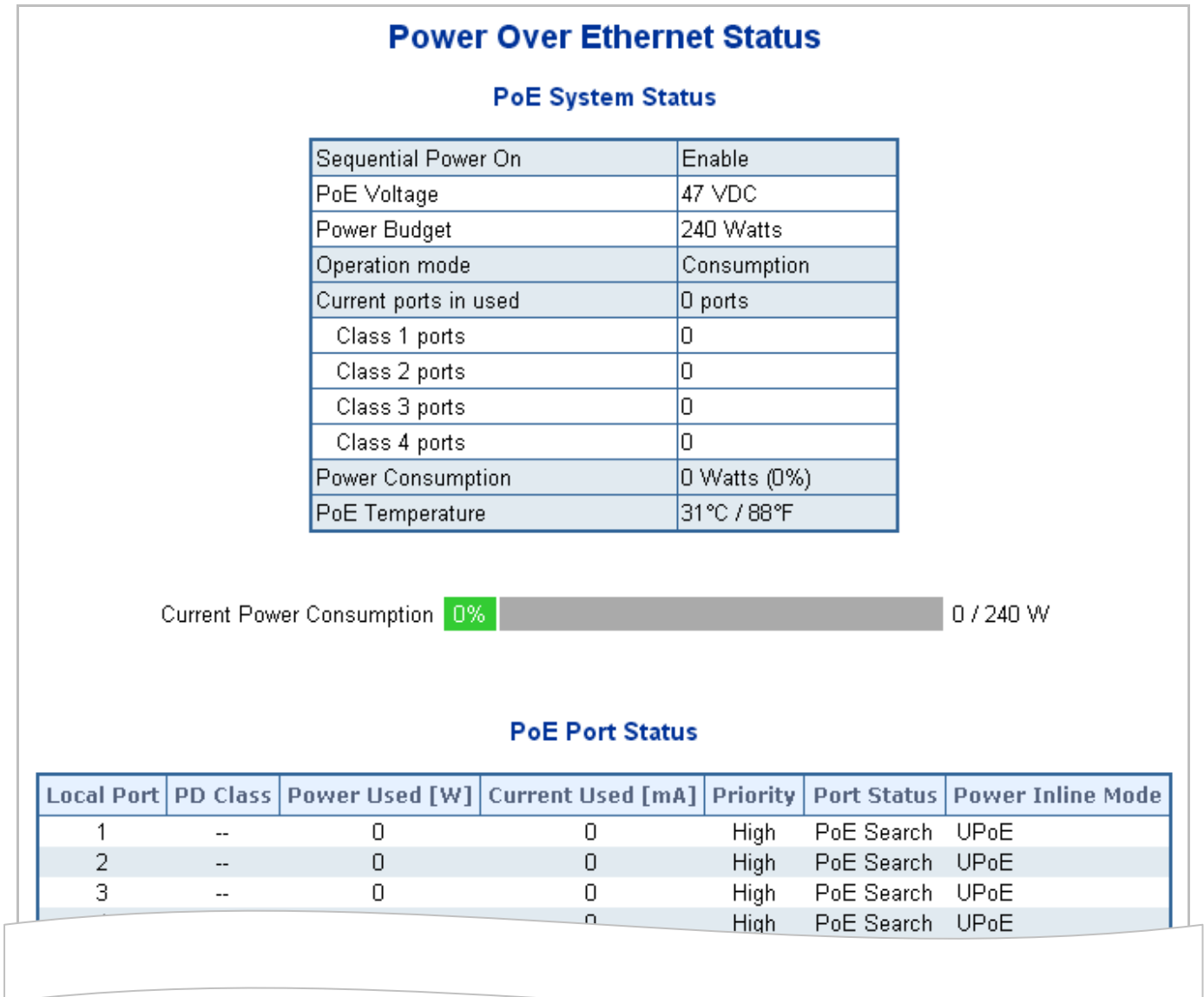

Figure 4-6-1-4: PoE Status Screenshot

The page includes the following fields:

| Object | Description |
|------------------------------|--|
| • Sequential Power On | Displays the current sequential power on mode. |
| • PoE Voltage | Displays the current PoE voltage. |
| • System Power Budget | Displays the maximum PoE power budget. |
| • Operation Mode | Displays the current PoE operation mode. |
| • Current Budget | Displays the current maximum PoE budget. |

| | |
|------------------------------------|---|
| • Current Ports in Use | Displays the current PoE ports in use. |
| • Class 1 ~ 4 ports | Displays the current ports of PoE class 1 ~ 4. |
| • Power Consumption | Displays the current power consumption (total watts and percentage) |
| • PoE Temperature | Displays the current operating temperature of the first PoE chip unit. |
| • Current Power Consumption | Shows the total watts usage of Managed PoE Switch. |
| • Total Power Reserved | Shows how much the total power is reserved for all PDs. |
| • Temperature | Displays the current operating temperature of the PoE chip unit. |
| • Local Port | This is the logical port number for this row. |
| • PD Class | Displays the class of the PD attached to the port, as established by the classification process. Class 0 is the default for PDs. The PD is powered based on PoE Class level if system is working in Classification mode. A PD will return Class to 0 to 4 in accordance with the maximum power draw as specified by Table 4-6-1-1 . |
| • Power Used [W] | The Power Used shows how much power the PD currently is using. |
| • Current Used [mA] | The Power Used shows how much current the PD currently is using. |
| • Priority | The Priority shows the port's priority configured by the user. |
| • Port Status | The Port Status shows the port's status. |
| • Power Inline Mode | Displays per PoE port operating in mid-span, end-span or UPoE mode. |
| • Total | Shows the total power and current usage of all PDs. |

Buttons

Auto-refresh Check this box to enable an automatic refresh of the page at regular intervals.

: Click to refresh the page immediately.

4.6.1.6 Port Sequential

This page allows the user to configure the PoE Ports started up interval time. The PoE Port will start up one by one as [Figure 4-6-1-5](#) shows.

Port Sequential Power up Interval

| | |
|--|--|
| Sequential Power up Option | Enable <input type="button" value="v"/> |
| Sequential Power up Interval | 5 <input type="text"/> (3 ~ 30) seconds |
| Sequential Power up Port Option | By port <input type="button" value="v"/> |

Figure 4-6-1-5: PoE Port Sequential Power Up Interval Configuration Screenshot



The PoE port will start up after the whole system program has finished running.

The page includes the following fields:

| Object | Description |
|--|---|
| <ul style="list-style-type: none"> • Sequential Power up Option | Allows user to enable or disable Sequential Power up function. |
| <ul style="list-style-type: none"> • Sequential Power up Interval | Allows user to configure the PoE Port Start Up interval time. |
| <ul style="list-style-type: none"> • Sequential Power up Port Option | There are two modes for Starting Up the PoE Port By Port: The PoE Port will start up by following Port number. By Priority: The PoE Port will start up by following the PoE Priority. |

Buttons



: Click to apply changes



: Click to undo any changes made locally and revert to previously saved values.

4.6.1.7 PoE Schedule

This page allows the user to define PoE schedule and schedule power recycle.

PoE Schedule

Besides being used as an IP Surveillance, the Managed PoE switch is certainly applicable to constructing any PoE network including VoIP and Wireless LAN. Under the trend of energy saving worldwide and contributing to the environmental protection on the Earth, the Managed PoE switch can effectively control the power supply besides its capability of giving high watts power.

The **“PoE schedule”** function helps you to enable or disable PoE power feeding for each PoE port during specified time intervals and it is a powerful function to help SMBs or Enterprises save power and budget.

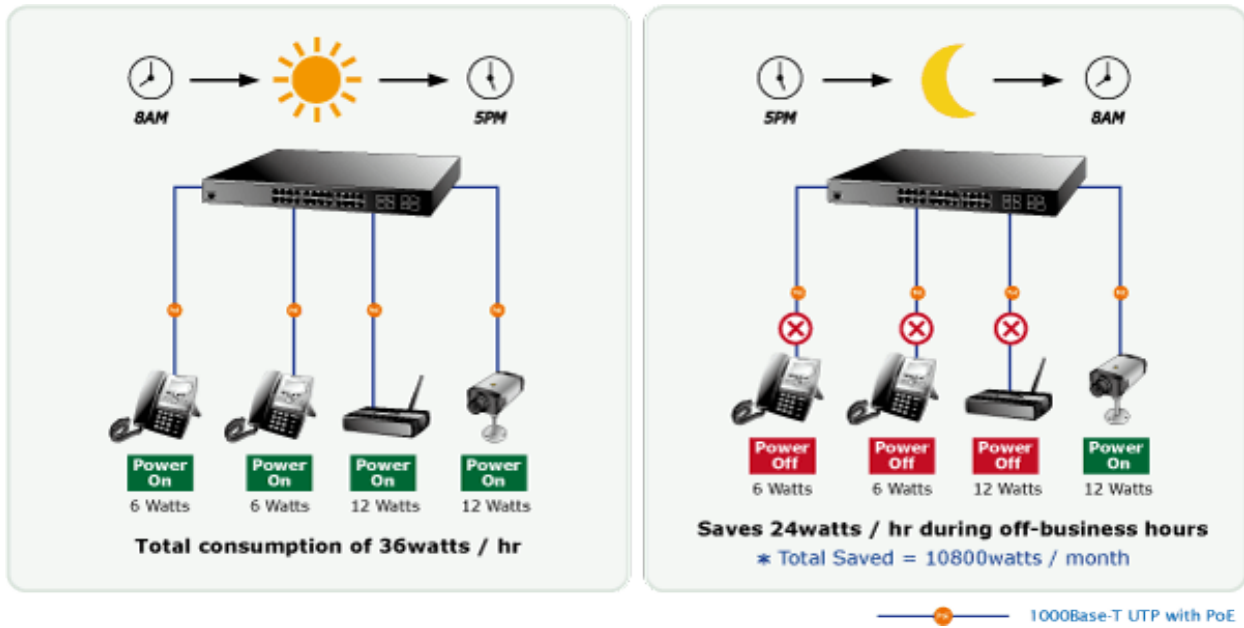

Scheduled Power Recycling

The Managed PoE switch allows each of the connected PoE IP cameras to reboot in a specific time each week. Therefore, it will reduce the chance of IP camera crash resulting from buffer overflow. The screen in Figure 4-6-1-6 appears.

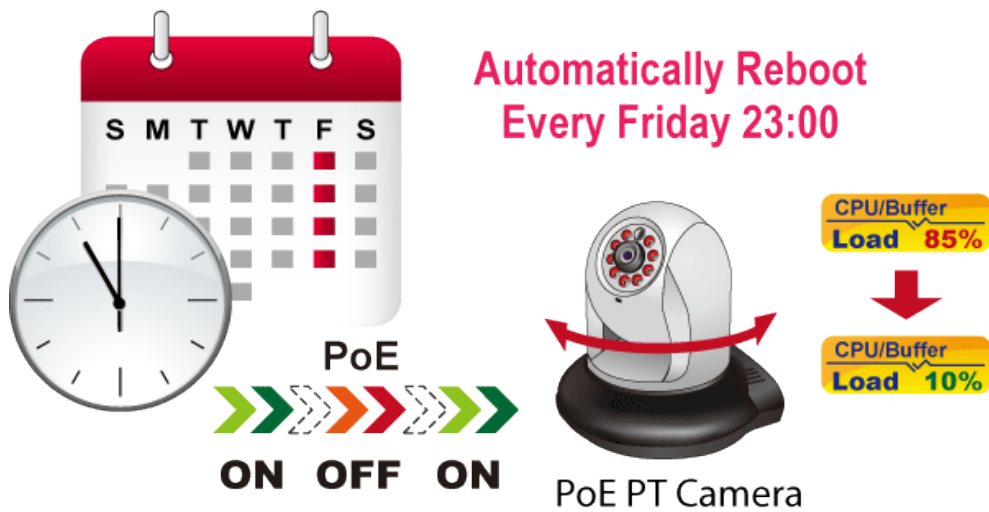

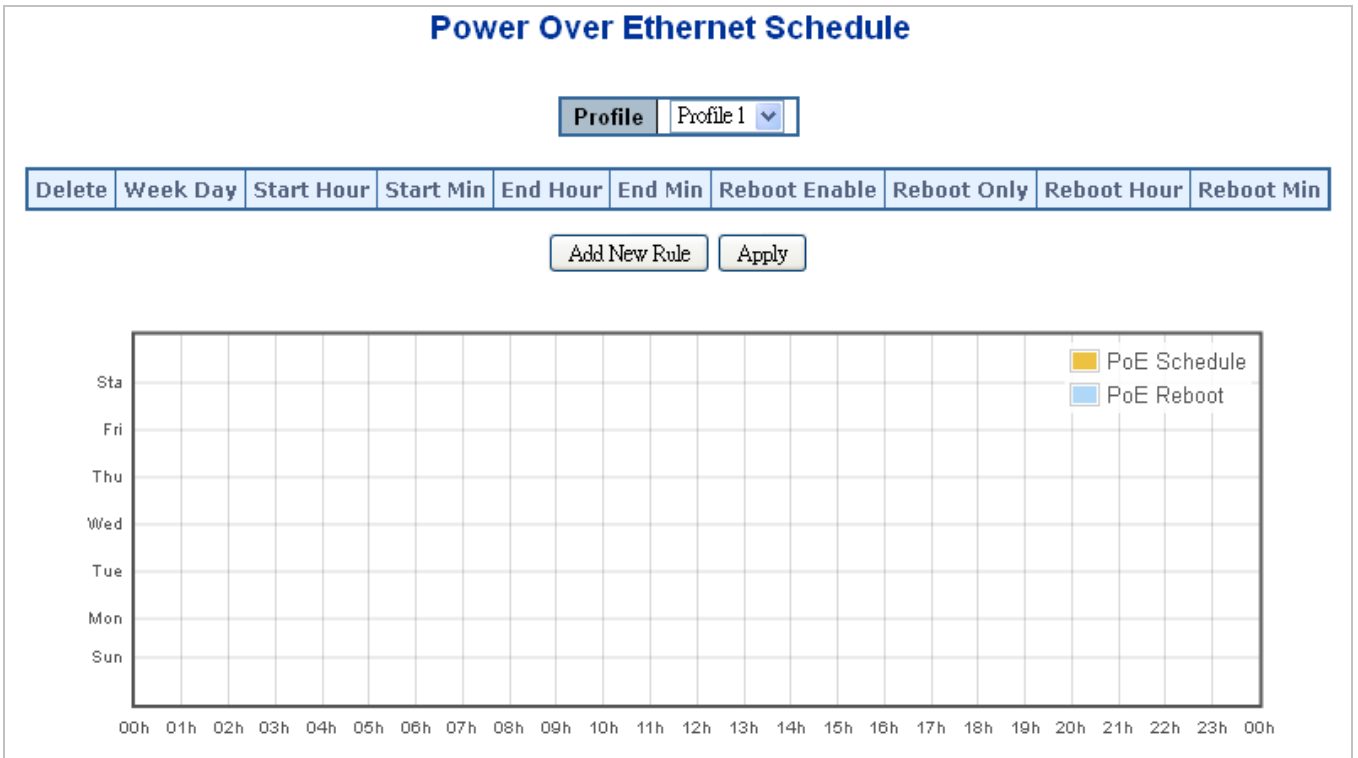

Figure 4-6-1-6: PoE Schedule Screenshot

Please press the **Add New Rule** button to start setting PoE Schedule function. You have to set PoE schedule to profile and then go back to PoE Port Configuration, and select **"Schedule"** mode from per port **"PoE Mode"** option. You can then indicate which schedule profile could be applied to the PoE port.

The page includes the following fields:

| Object | Description |
|--|---|
| <ul style="list-style-type: none"> Profile | Set the schedule profile mode. Possible profiles are: Profile1 Profile2 Profile3 Profile4 |
| <ul style="list-style-type: none"> Week Day | Allows user to set week day for defining PoE function should be enabled on the day. |
| <ul style="list-style-type: none"> Start Hour | Allows user to set what hour does PoE function enables. |
| <ul style="list-style-type: none"> Start Min | Allows user to set what minute does PoE function enables. |
| <ul style="list-style-type: none"> End Hour | Allows user to set what hour does PoE function disables. |
| <ul style="list-style-type: none"> End Min | Allows user to set what minute does PoE function disables. |
| <ul style="list-style-type: none"> Reboot Enable | Allows user to enable or disable whole PoE port reboot by PoE reboot schedule. |

| | |
|--|--|
| | <p>Please be noticed that if you want to PoE schedule and PoE reboot schedule work at the same time, please use this function, and don't use Reboot Only function.</p> <p>This function offers administrator to reboot PoE device at indicate time if administrator has this kind of requirement.</p> |
| <ul style="list-style-type: none"> • Reboot Only | <p>Allows user to reboot PoE function by PoE reboot schedule. Please be noticed that if administrator enable this function, PoE schedule will not to set time to profile. This function is just for PoE port reset at an indicated time.</p> |
| <ul style="list-style-type: none"> • Reboot Hour | <p>Allows user to set what hour PoE reboots. This function only for PoE reboot schedule.</p> |
| <ul style="list-style-type: none"> • Reboot Min | <p>Allows user to set what minute PoE reboots. This function only for PoE reboot schedule.</p> |

Buttons

Add New Rule : click to add new rule.

Apply : Click to apply changes

Delete : Check to delete the entry.

4.6.1.8 PoE Alive Check Configuration

The IGS-5225-4UP1T2S/IGS-5225-8P2T2S PoE Switch can be configured to monitor connected PD's status in real-time via ping action. Once the PD stops working and without response, IGS-5225-4UP1T2S/IGS-5225-8P2T2S PoE Switch is going to restart PoE port power, and bring the PD back to work. It will greatly enhance the reliability and reduces administrator management burden.

This page provides you how to configure PD Alive Check. The screen in Figure 4-6-1-7 appears.

| Port | Mode | Ping PD IP Address | Interval Time(10~300s) | Retry Count(1~5) | Action | Reboot Time(30~180s) |
|------|-----------|--------------------|-------------------------|-------------------|---------|-----------------------|
| * | <All> ▼ | 0.0.0.0 | 30 | 2 | <All> ▼ | 90 |
| 1 | Disable ▼ | 0.0.0.0 | 30 | 2 | None ▼ | 90 |
| 2 | Disable ▼ | 0.0.0.0 | 30 | 2 | None ▼ | 90 |

Figure 4-6-1-7: PD Alive Check Configuration Screenshot

The page includes the following fields:

| Object | Description |
|--|---|
| <ul style="list-style-type: none"> • Mode | Allows user to enable or disable per port PD Alive Check function. As default value all ports are disabled. |
| <ul style="list-style-type: none"> • Ping PD IP Address | This column allows user to set PoE device IP address here for system making ping to the PoE device. Please be noticed that the PD's IP address must be set to the same network segment with IGS-5225-4UP1T2S/8P4S/8P2S/8P2S2X PoE Switch. |
| <ul style="list-style-type: none"> • Interval Time (10~300s) | This column allows user to set how long system should be issue a ping request to PD for detecting PD is alive or dead. Interval time range is from 10 seconds to 300 seconds. |
| <ul style="list-style-type: none"> • Retry Count (1~5) | This column allows user to set how many times system rerry ping to PD. For example, if we set count 2, the meaning is that if system retry ping to the PD and the PD doesn't response continuously, the PoE port will be reset. |
| <ul style="list-style-type: none"> • Action | Allows user to set which action will be apply if the PD witout any response. IGS-5225-4UP1T2S/8P4S/8P2S/8P2S2X PoE Switch offers 3 actions as following. <ul style="list-style-type: none"> ➤ PD Reboot: It menas system will reset the PoE port that connected the PD. ➤ Reboot & Alarm: It means system will reset the PoE port and issue an alarm message via Syslog, SMTP. ➤ Alarm: It means system will issue an alarm message via Syslog, SMTP. |
| <ul style="list-style-type: none"> • Reboot Time (30~180s) | This column allows user to set the PoE device rebooting time, due to there are so many kind of PoE device on the market and theyhave different rebooting time. The PD Alive-check is not a defining standard, so the PoE device on the market doesn't report reboots done information to IGS-5225-4UP1T2S/8P4S/8P2S/8P2S2X PoE Switch, so user has to make sure how long the PD will be finished to boot, and then set the time value to this column. System is going to check the PD again according to the reboot time. If ou can not make sure precisely booting time, we suggest you to set it longer. |

Buttons

: Click it to save changes.

: Click it to reset configuration which doesn't to be saved yet.

4.6.1.9 LLDP PoE Neighbors

This page provides a status overview for all LLDP PoE neighbors. The displayed table contains a row for each port on which an LLDP PoE neighbor is detected. The columns hold the following information: The screen in Figure 4-6-1-8 appears.

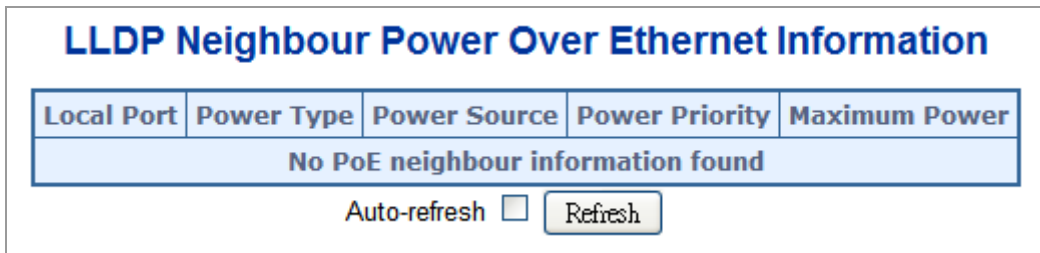

Figure 4-6-1-8: LLDP PoE Neighbor Screenshot

Please note that administrator has to enable LLDP port from LLDP configuration, please refer to the following example (The screen in Figure 4-6-1-9 appears.) To enable LLDP function from port1 to port3, administrator has to plug a PD that supports PoE LLDP function, and then administrator is going to see the PoE information of the PD from LLDP.

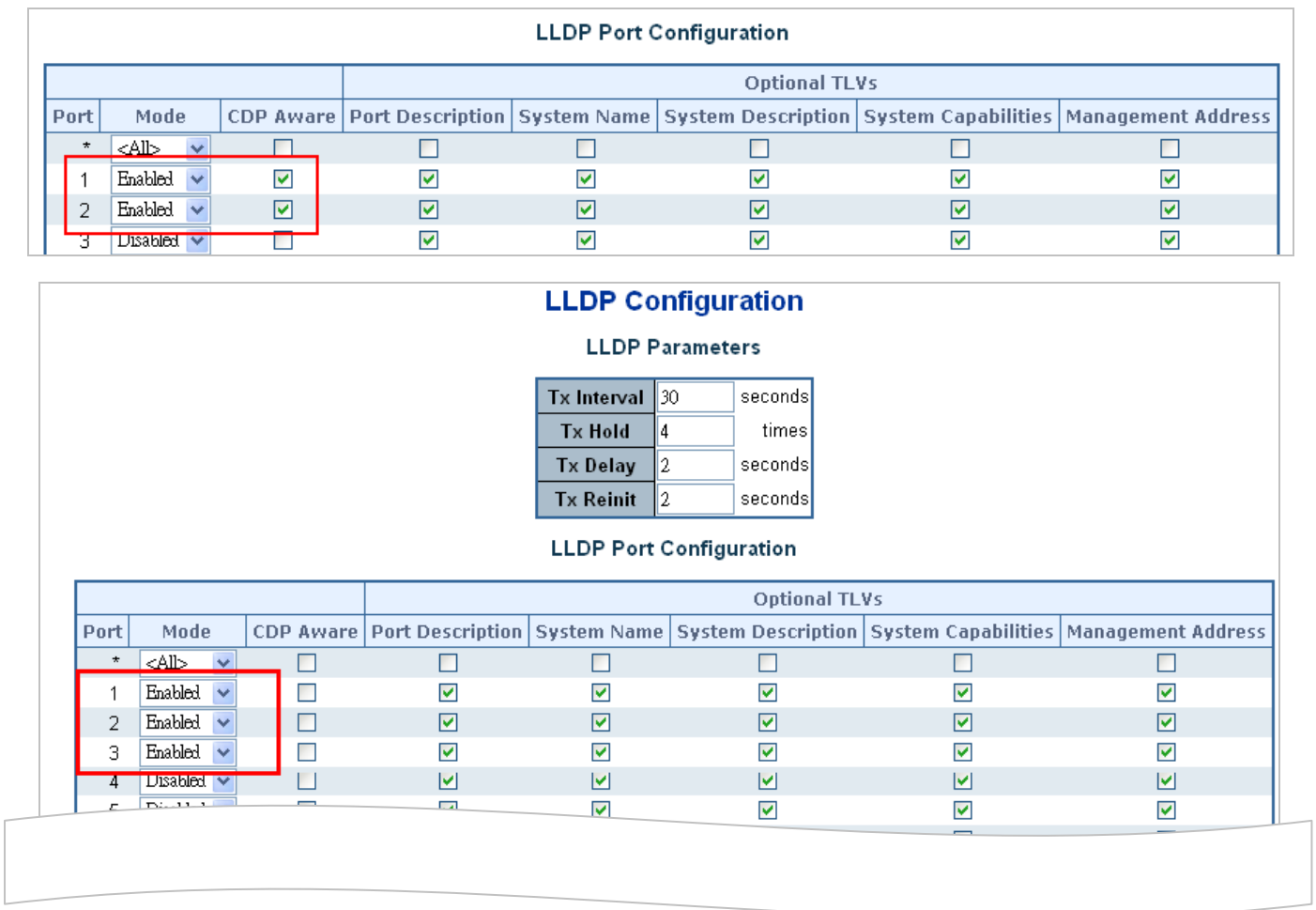

Figure 4-6-1-9: LLDP Configuration Screenshot.

4.7 Ring

4.7.1 Ring

ITU-T G.8032 **Ethernet Ring protection switching (ERPS)** is a link layer protocol applied on Ethernet loop protection to provide sub-50ms protection and recovery switching for Ethernet traffic in a ring topology.

ERPS provides a faster redundant recovery than Spanning Tree topology. The action is similar to STP or RSTP, but the algorithms between them are not the same. In the Ring topology, every switch should be enabled with Ring function and two ports should be assigned as the member ports in the ERPS. Only one switch in the Ring group would be set as the RPL owner switch that one port would be blocked, called **owner port**, and PRL neighbor switch has one port that one port would be blocked, called **neighbor port** that connect to owner port directly and this link is called the **Ring Protection Link** or **RPL**. Each switch will send ETH-CCM message to check the link status in the ring group. When the failure of network connection occurs, the nodes block the failed link and report the signal failure message, the RPL owner switch will automatically unblocks the PRL to recover from the failure.

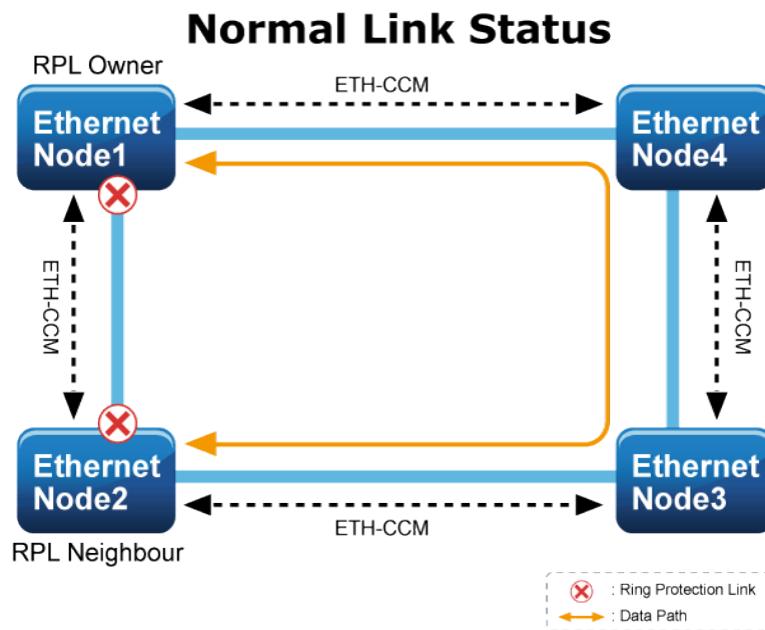

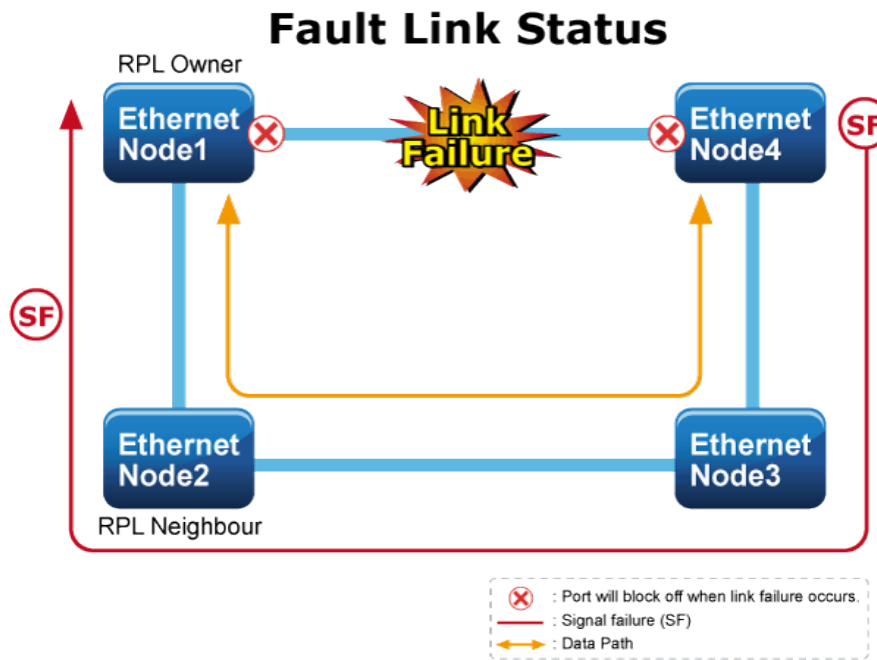

4.7.1.1 MEP Configuration

The Maintenance Entity Point instances are configured here; screen in [Figure 4-7-1-1](#) appears.

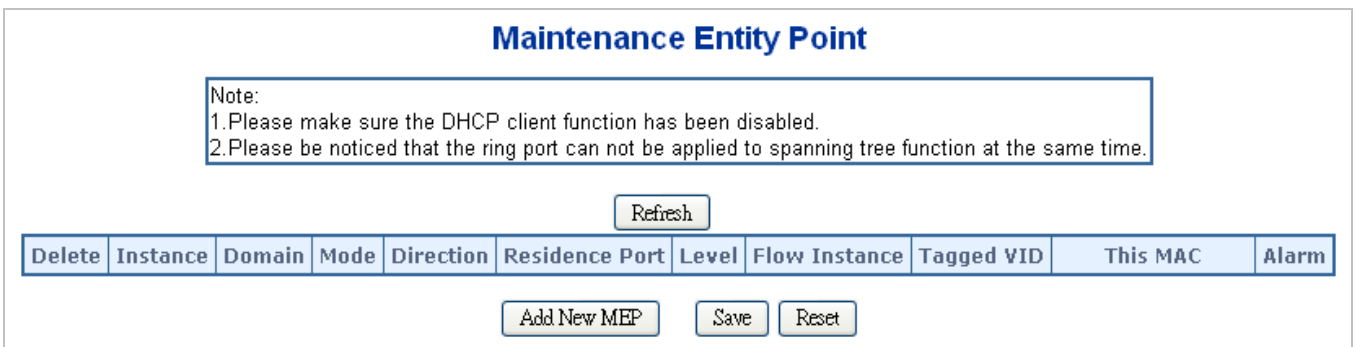

Figure 4-7-1-1: MEP configuration page screenshot

The page includes the following fields:

| Object | Description |
|-------------------|--|
| • Delete | This box is used to mark a MEP for deletion in next Save operation. |
| • Instance | The ID of the MEP. Click on the ID of a MEP to enter the configuration page. |
| • Domain | <p>Port: This is a MEP in the Port Domain. 'Flow Instance' is a Port.</p> <p>Esp: Future use</p> <p>Evc: This is a MEP in the EVC Domain. 'Flow Instance' is a EVC</p> <p>Mpls: Future use</p> |
| • Mode | <p>MEP: This is a Maintenance Entity End Point.</p> <p>MIP: This is a Maintenance Entity Intermediate Point.</p> |

| | |
|-------------------------|--|
| • Direction | <p>Ingress: This is a Ingress (down) MEP - monitoring ingress traffic on 'Residence Port'.</p> <p>Egress: This is a Egress (up) MEP - monitoring egress traffic on 'Residence Port'.</p> |
| • Residence Port | The port where MEP is monitoring - see 'Direction'. |
| • Level | The MEG level of this MEP. |
| • Flow Instance | The MEP is related to this flow - See 'Domain'. |
| • Tagged VID | <p>Port MEP: An outer C/S-tag (depending on VLAN Port Type) is added with this VID.</p> <p>Entering '0' means no TAG added.</p> |
| • This MAC | The MAC of this MEP - can be used by other MEP when unicast is selected (Info only). |
| • Alarm | There is an active alarm on the MEP. |

Buttons

Add New MEP

: Click to add a new MEP entry

Refresh

: Click to refresh the page immediately.

Save

: Click to save changes.

Reset

: Click to undo any changes made locally and revert to previously saved values.

4.7.1.2 Detailed MEP Configuration

This page allows the user to inspect and configure the current MEP Instance.; screen in [Figure 4-7-1-2](#) appears.

MEP Configuration

Instance Data

| Instance | Domain | Mode | Direction | Residence Port | Flow Instance | Tagged VID | EPS Instance | This MAC |
|----------|--------|------|-----------|----------------|---------------|------------|--------------|-------------------|
| 1 | Port | Mep | Down | 1 | 1 | 0 | 0 | 00-01-C1-00-00-01 |

Instance Configuration

| Level | Format | Domain Name | MEG ID | MEP ID | Tagged VID | cLevel | cMEG | cMEP | cAIS | cLCK | cSSF | aBLK | aTSF |
|-------|---------|-------------|---------------|--------|------------|-------------------------------------|-------------------------------------|-------------------------------------|-------------------------------------|-------------------------------------|-------------------------------------|-------------------------------------|-------------------------------------|
| 0 | ITU ICC | | ICC000MEG0000 | 1 | 0 | <input checked="" type="checkbox"/> | <input checked="" type="checkbox"/> | <input checked="" type="checkbox"/> | <input checked="" type="checkbox"/> | <input checked="" type="checkbox"/> | <input checked="" type="checkbox"/> | <input checked="" type="checkbox"/> | <input checked="" type="checkbox"/> |

Peer MEP Configuration

| Delete | Peer MEP ID | Unicast Peer MAC | cLOC | cRDI | cPeriod | cPriority |
|-------------------|-------------|------------------|------|------|---------|-----------|
| No Peer MEP Added | | | | | | |

Functional Configuration

| Continuity Check | | | APS Protocol | | | | |
|--------------------------|----------|------------|--------------------------|----------|-------|-------|------------|
| Enable | Priority | Frame rate | Enable | Priority | Cast | Type | Last Octet |
| <input type="checkbox"/> | 0 | 1 f/sec | <input type="checkbox"/> | 0 | Multi | R-APS | 1 |

Figure 4-7-1-2: Detail MEP configuration page screenshot

The page includes the following fields:

Instance Data:

| Object | Description |
|------------------|-----------------------------|
| • Instance | The ID of the MEP. |
| • Domain | See help on MEP create WEB. |
| • Mode | See help on MEP create WEB. |
| • Direction | See help on MEP create WEB. |
| • Residence Port | See help on MEP create WEB. |
| • Flow Instance | See help on MEP create WEB. |
| • Tagged VID | See help on MEP create WEB. |
| • This MAC | See help on MEP create WEB. |

Instance Configuration:

| Object | Description |
|----------|--|
| • Level | See help on MEP create WEB. |
| • Format | This is the configuration of the two possible Maintenance Association Identifier |

| | |
|---------------------------|--|
| | <p>formats.</p> <p>ITU ICC: This is defined by ITU. 'ICC' can be max. 6 char. 'MEG id' can be max. 7 char.</p> <p>IEEE String: This is defined by IEEE. 'Domain Name' can be max. 8 char. 'MEG id' can be max. 8 char.</p> |
| • Domain Name | This is either ITU ICC (MEG ID value[1-6]) or IEEE Maintenance Domain Name - depending on 'Format'. See 'Format'. |
| • MEG Id | This is either ITU UMC (MEG ID value[7-13]) or IEEE Short MA Name - depending on 'Format'. See 'Format'. In case of ITU ICC format this can be max. 7 char. If only 6 char. is entered the MEG ID value[13] will become NULL. |
| • MEP Id | This value will become the transmitted two byte CCM MEP ID. |
| • cLevel | Fault Cause indicating that a CCM is received with a lower level than the configured for this MEP. |
| • cMEG | Fault Cause indicating that a CCM is received with a MEG ID different from configured for this MEP. |
| • cMEP | Fault Cause indicating that a CCM is received with a MEP ID different from all 'Peer MEP ID' configured for this MEP. |
| • cAIS | Fault Cause indicating that AIS PDU is received. |
| • cLCK | Fault Cause indicating that LCK PDU is received. |
| • cSSF | Fault Cause indicating that server layer is indicating Signal Fail. |
| • aBLK | The consequent action of blocking service frames in this flow is active. |
| • aTSF | The consequent action of indicating Trail Signal Fail to-wards protection is active. |
| • Delete | This box is used to mark a Peer MEP for deletion in next Save operation. |
| • Peer MEP ID | This value will become an expected MEP ID in a received CCM - see 'cMEP'. |
| • Unicast Peer MAC | This MAC will be used when unicast is selected with this peer MEP. Also this MAC is used to create HW checking of receiving CCM PDU (LOC detection) from this MEP. |
| • cLOC | Fault Cause indicating that no CCM has been received (in 3,5 periods) - from this peer MEP. |
| • cRDI | Fault Cause indicating that a CCM is received with Remote Defect Indication - from this peer MEP. |
| • cPeriod | Fault Cause indicating that a CCM is received with a period different what is configured for this MEP - from this peer MEP. |
| • cPriority | Fault Cause indicating that a CCM is received with a priority different what is configured for this MEP - from this peer MEP. |

Buttons

Add New Peer MEP: Click to add a new peer MEP.

Functional Configuration

Continuity Check:

| Object | Description |
|---|--|
| <ul style="list-style-type: none"> • Enable | Continuity Check based on transmitting/receiving CCM PDU can be enabled/disabled. The CCM PDU is always transmitted as Multi-cast Class 1. |
| <ul style="list-style-type: none"> • Priority | The priority to be inserted as PCP bits in TAG (if any). In case of enable of Continuity Check and Loss Measurement both implemented on SW based CCM, 'Priority' has to be the same. |
| <ul style="list-style-type: none"> • Frame rate | <p>Selecting the frame rate of CCM PDU. This is the inverse of transmission period as described in Y.1731. This value has the following uses:</p> <ul style="list-style-type: none"> * The transmission rate of the CCM PDU. * Fault Cause cLOC is declared if no CCM PDU has been received within 3.5 periods - see 'cLOC'. * Fault Cause cPeriod is declared if a CCM PDU has been received with different period - see 'cPeriod'. <p>Selecting 300f/sec or 100f/sec will configure HW based CCM (if possible). Selecting other frame rates will configure SW based CCM. In case of enable of Continuity Check and Loss Measurement both implemented on SW based CCM, 'Frame Rate' has to be the same.</p> |

APS Protocol:

| Object | Description |
|---|---|
| <ul style="list-style-type: none"> • Enable | Automatic Protection Switching protocol information transportation based on transmitting/receiving R-APS/L-APS PDU can be enabled/disabled. Must be enabled to support ERPS/ELPS implementing APS. This is only valid with one Peer MEP configured. |
| <ul style="list-style-type: none"> • Priority | The priority to be inserted as PCP bits in TAG (if any). |
| <ul style="list-style-type: none"> • Cast | Selection of APS PDU transmitted unicast or multi-cast. The unicast MAC will be taken from the 'Unicast Peer MAC' configuration. Unicast is only valid for L-APS - see 'Type'. The R-APS PDU is always transmitted with multi-cast MAC described in G.8032. |

| | |
|---|---|
| <ul style="list-style-type: none"> • Type | <p>R-APS: APS PDU is transmitted as R-APS - this is for ERPS.</p> <p>L-APS: APS PDU is transmitted as L-APS - this is for ELPS.</p> |
| <ul style="list-style-type: none"> • Last Octet | <p>This is the last octet of the transmitted and expected RAPS multi-cast MAC. In G.8031 (03/2010) a RAPS multi-cast MAC is defined as 01-19-A7-00-00-XX. In current standard the value for this last octet is '01' and the usage of other values is for further study.</p> |

Buttons

- : Click to go to Fault Management page.
- : Click to go to Performance Monitor page.
- : Click to refresh the page immediately.
- : Click to save changes.
- : Click to undo any changes made locally and revert to previously saved values.

4.7.1.3 Ethernet Ring Protocol Switch

The Ethernet Ring Protection Switch instances are configured here; screen in [Figure 4-7-1-3](#) appears.

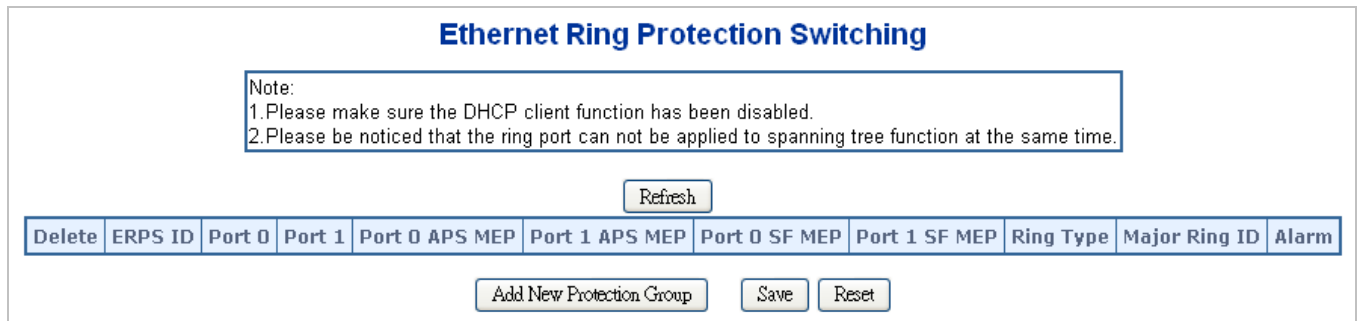

Figure 4-7-1-3: Ethernet Ring Protocol Switch page screenshot

The page includes the following fields:

| Object | Description |
|--|--|
| <ul style="list-style-type: none"> • Delete | This box is used to mark an ERPS for deletion in next Save operation. |
| <ul style="list-style-type: none"> • Port 0 | This will create a Port 0 of the switch in the ring. |
| <ul style="list-style-type: none"> • Port 1 | This will create "Port 1" of the switch in the Ring. As interconnected sub-ring will have only one ring port, "Port 1" is configured as "0" for interconnected sub-ring. "0" in this field indicates that no "Port 1" is associated with this instance |
| <ul style="list-style-type: none"> • Port 0 SF MEP | The Port 0 Signal Fail reporting MEP. |
| <ul style="list-style-type: none"> • Port 1 SF MEP | The Port 1 Signal Fail reporting MEP. As only one SF MEP is associated with |

| | |
|------------------|--|
| | interconnected sub-ring without virtual channel, it is configured as "0" for such ring instances. "0" in this field indicates that no Port 1 SF MEP is associated with this instance. |
| • Port 0 APS MEP | The Port 0 APS PDU handling MEP. |
| • Port 1 APS MEP | The Port 1 APS PDU handling MEP. As only one APS MEP is associated with interconnected sub-ring without virtual channel, it is configured as "0" for such ring instances. "0" in this field indicates that no Port 1 APS MEP is associated with this instance. |
| • Ring Type | Type of Protecting ring. It can be either major ring or sub-ring. |
| • Major Ring ID | Major ring group ID for the interconnected sub-ring. It is used to send topology change updates on major ring. If ring is major, this value is same as the protection group ID of this ring. |
| • Alarm | There is an active alarm on the ERPS. |

Buttons

Add New Protection Group: Click to add a new Protection group entry.

Refresh: Click to refresh the page immediately.

Save: Click to save changes.

Reset: Click to undo any changes made locally and revert to previously saved values.

4.7.1.4 Ethernet Ring Protocol Switch Configuration

This page allows the user to inspect and configure the current ERPS Instance; screen in [Figure 4-7-1-4](#) appears.

ERPS Configuration 1

Auto-refresh

Instance Data

| ERPS ID | Port 0 | Port 1 | Port 0 SF MEP | Port 1 SF MEP | Port 0 APS MEP | Port 1 APS MEP | Ring Type |
|---------|--------|--------|---------------|---------------|----------------|----------------|------------|
| 1 | 1 | 2 | 1 | 2 | 1 | 2 | Major Ring |

Instance Configuration

| Configured | Guard Time | WTR Time | Hold Off Time | Version | Revertive | VLAN config |
|--------------------------------------|------------|----------|---------------|---------|-------------------------------------|-------------|
| ● | 500 | 1min | 0 | v2 | <input checked="" type="checkbox"/> | VLAN Config |

RPL Configuration

| RPL Role | RPL Port | Clear |
|----------|----------|--------------------------|
| None | None | <input type="checkbox"/> |

Instance Command

| Command | Port |
|---------|------|
| None | None |

Instance State

| Protection State | Port 0 | Port 1 | Transmit APS | Port 0 Receive APS | Port 1 Receive APS | WTR Remaining | RPL Un-blocked | No APS Received | Port 0 Block Status | Port 1 Block Status | FOP Alarm |
|------------------|--------|--------|--------------|--------------------|--------------------|---------------|--------------------------------------|------------------------------------|---------------------|---------------------|--------------------------------------|
| Protected | SF | SF | SF DNF BPRO | | | 0 | ● | ● | Blocked | Blocked | ● |

Figure 4-7-1-4: Ethernet Ring Protocol Switch Configuration page screenshot

The page includes the following fields:

Instance Data:

| Object | Description |
|------------------|---|
| • ERPS ID | The ID of the Protection group. |
| • Port 0 | See help on ERPS create WEB. |
| • Port 1 | See help on ERPS create WEB. |
| • Port 0 SF MEP | See help on ERPS create WEB. |
| • Port 1 SF MEP | See help on ERPS create WEB. |
| • Port 0 APS MEP | See help on ERPS create WEB. |
| • Port 1 APS MEP | See help on ERPS create WEB. |
| • Ring Type | Type of Protecting ring. It can be either major ring or sub-ring. |

Instance Configuration:

| Object | Description |
|-----------------|---|
| • Configuration | <p>Red: This ERPS is only created and has not yet been configured - is not active.</p> <p>Green: This ERPS is configured - is active.</p> |

| | |
|--|--|
| <ul style="list-style-type: none"> • Guard Time | <p>Guard timeout value to be used to prevent ring nodes from receiving outdated R-APS messages.</p> <p>The period of the guard timer can be configured in 10 ms steps between 10 ms and 2 seconds, with a default value of 500 ms</p> |
| <ul style="list-style-type: none"> • WTR Time | <p>The Wait To Restore timing value to be used in revertive switching.</p> <p>The period of the WTR time can be configured by the operator in 1 minute steps between 5 and 12 minutes with a default value of 5 minutes.</p> |
| <ul style="list-style-type: none"> • Hold Off Time | <p>The timing value to be used to make persistent check on Signal Fail before switching.</p> <p>The range of the hold off timer is 0 to 10 seconds in steps of 100 ms</p> |
| <ul style="list-style-type: none"> • Version | <p>ERPS Protocol Version - v1 or v2</p> |
| <ul style="list-style-type: none"> • Revertive | <p>In Revertive mode, after the conditions causing a protection switch has cleared, the traffic channel is restored to the working transport entity, i.e., blocked on the RPL.</p> <p>In Non-Revertive mode, the traffic channel continues to use the RPL, if it is not failed, after a protection switch condition has cleared.</p> |
| <ul style="list-style-type: none"> • VLAN Config | <p>VLAN configuration of the Protection Group. Click on the "VLAN Config" link to configure VLANs for this protection group.</p> |

PRL Configuration:

| Object | Description |
|---|---|
| <ul style="list-style-type: none"> • PRL Role | <p>It can be either RPL owner or RPL Neighbor.</p> |
| <ul style="list-style-type: none"> • PRL Port | <p>This allows to select the east port or west port as the RPL block.</p> |
| <ul style="list-style-type: none"> • Clear | <p>If the owner has to be changed, then the clear check box allows to clear the RPL owner for that ERPS ring.</p> |

Instance Command:

| Object | Description |
|--|--|
| <ul style="list-style-type: none"> • Command | <p>Administrative command. A port can be administratively configured to be in either manual switch or forced switch state.</p> |
| <ul style="list-style-type: none"> • Port | <p>Port selection - Port0 or Port1 of the protection Group on which the command is applied.</p> |

Instance State:

| Object | Description |
|------------------------------|---|
| • Protection State | ERPS state according to State Transition Tables in G.8032. |
| • Port 0 | OK: State of East port is ok SF: State of East port is Signal Fail |
| • Port 1 | OK: State of West port is ok SF: State of West port is Signal Fail |
| • Transmit APS | The transmitted APS according to State Transition Tables in G.8032. |
| • Port 0 Receive APS | The received APS on Port 0 according to State Transition Tables in G.8032. |
| • Port 1 Receive APS | The received APS on Port 1 according to State Transition Tables in G.8032. |
| • WTR Remaining | Remaining WTR timeout in milliseconds. |
| • RPL Un-blocked | APS is received on the working flow. |
| • No APS Received | RAPS PDU is not received from the other end. |
| • Port 0 Block Status | Block status for Port 0 (Both traffic and R-APS block status). R-APS channel is never blocked on sub-rings without virtual channel. |
| • Port 1 Block Status | Block status for Port 1 (Both traffic and R-APS block status). R-APS channel is never blocked on sub-rings without virtual channel. |
| • FOP Alarm | Failure of Protocol Defect(FOP) status. If FOP is detected, red LED glows; else green LED glows. |

Buttons

: Click to save changes.

Auto-refresh : Check this box to refresh the page automatically. Automatic refresh occurs every 6 seconds.

: Click to refresh the page immediately.

: Click to undo any changes made locally and revert to previously saved values.

4.7.1.5 Ethernet Ring Protocol Switch

This page allows the user to configure the ERPS by wizard; screen in [Figure 4-7-1-5](#) appears.

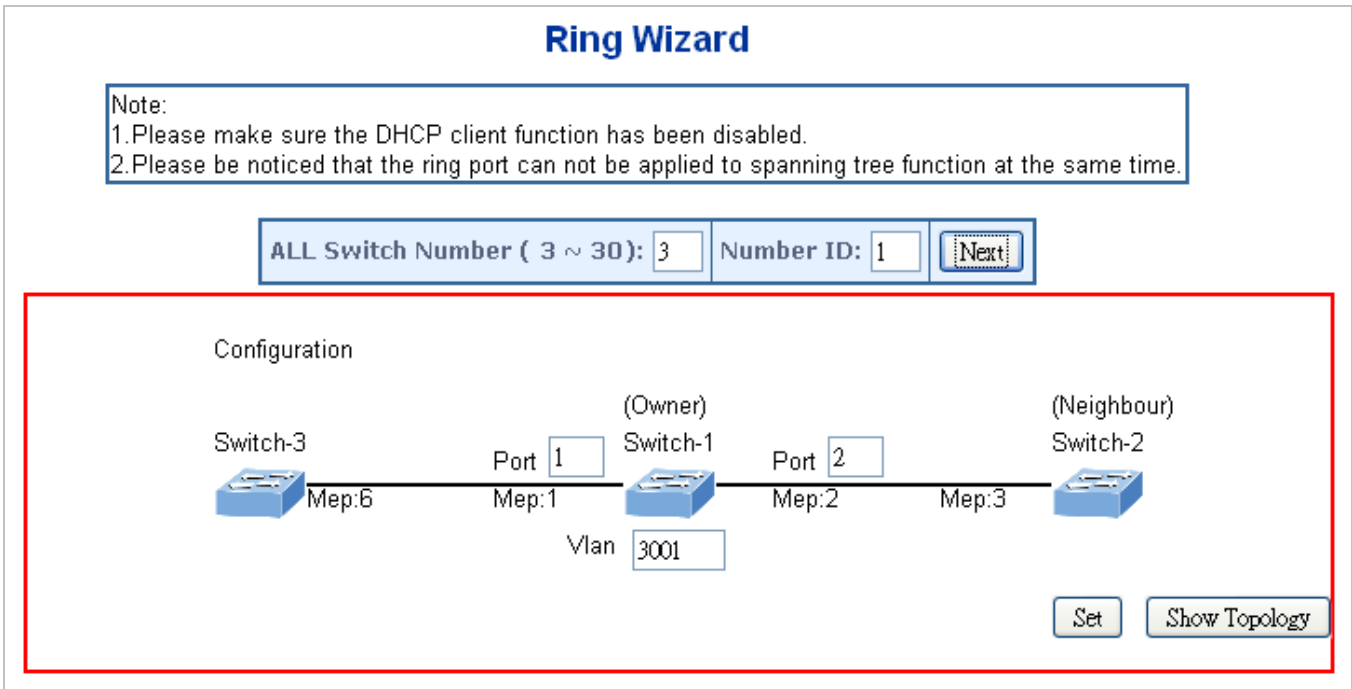



Figure 4-7-1-5: Ring Wizard page screenshot

The page includes the following fields:

| Object | Description |
|--|--|
| <ul style="list-style-type: none"> All Switch Numbers | Set all the switch numbers for the ring group. The default number is 3 and maximum number is 30. |
| <ul style="list-style-type: none"> Number ID | The switch where you are requesting ERPS. |
| <ul style="list-style-type: none"> Port | Configures the port number for the MEP. |
| <ul style="list-style-type: none"> VLAN | Set the ERPS VLAN. |

Buttons

: Click to configure ERPS.

: Click to save changes.

: Click to show the ring topology.

4.7.1.6 Ring Wizard Example

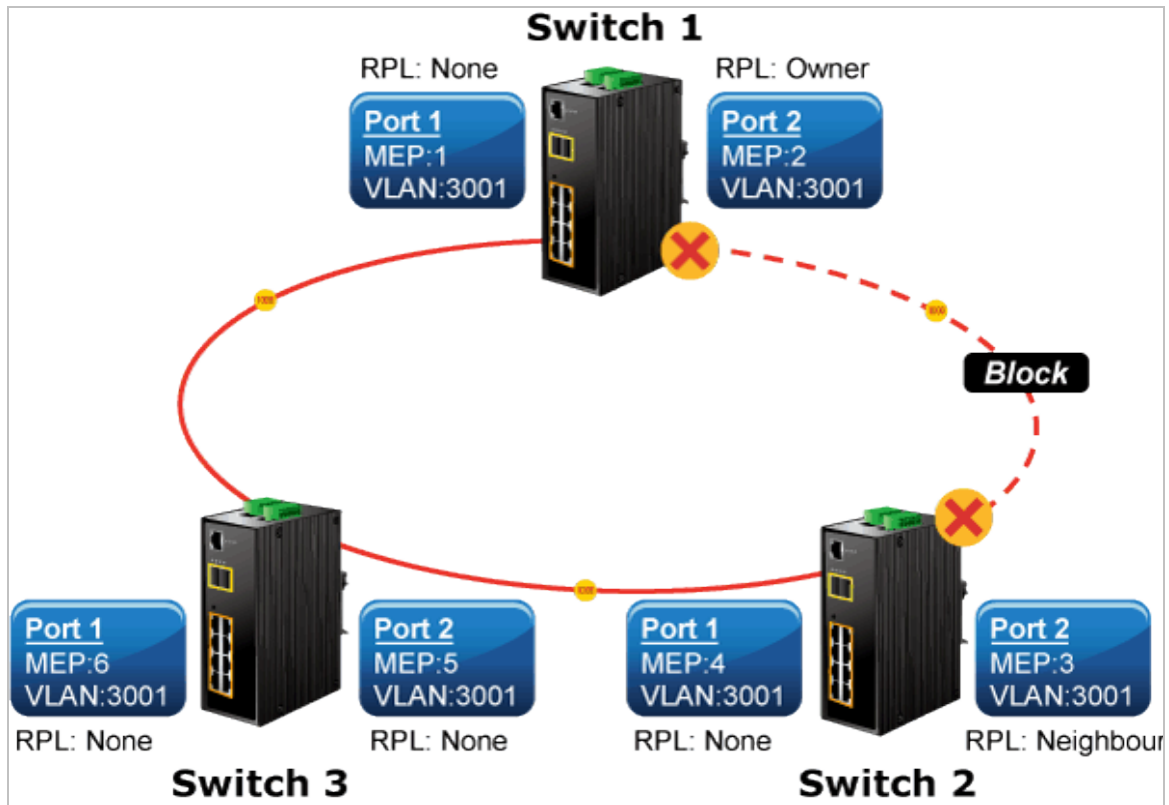

Figure 4-7-1-6: Ring Example Diagram

The above topology often occurs on using ERPS protocol. The multi switch constitutes a single ERPS ring; all of the switches only are configured as an ERPS in VLAN 3001, thereby constituting a single MRPP ring.

| Switch ID | Port | MEP ID | RPL Type | VLAN Group |
|-----------|--------|--------|-----------------|------------|
| Switch 1 | Port 1 | 1 | None | 3001 |
| | Port 2 | 2 | Owner | 3001 |
| Switch 2 | Port 1 | 4 | None | 3001 |
| | Port 2 | 3 | Neighbor | 3001 |
| Switch 3 | Port 1 | 6 | None | 3001 |
| | Port 2 | 5 | None | 3001 |

Table 4-7-1-1: ERPS Configuration Table

The scenario described as follows:

1. Disable DHCP client and set proper static IP for Switch 1, 2 & 3. In this example, switch 1 is 192.168.0.101; switch 2 is 192.168.0.102 and switch 3 is 192.168.0.103.
2. On switch 1, 2 & 3, disable spanning tree protocol to avoid confliction with ERPS.

Setup steps

Set ERPS Configuration on Switch 1

Connect PC to switch 1 directly; don't connect to port 1 & 2

Logging on the Switch 1 and click "Ring > Ring Wizard"

Set "All Switch Number" = 3 and "Number ID" = 1; click "Next" button to set the ERPS configuration for Switch 1.



ALL Switch Number (3 ~ 30): Number ID:

Set "MEP1" = Port1, "MEP2" = Port2 and VLAN ID = 3001; click "Set" button to save the ERPS configuration for Switch 1.

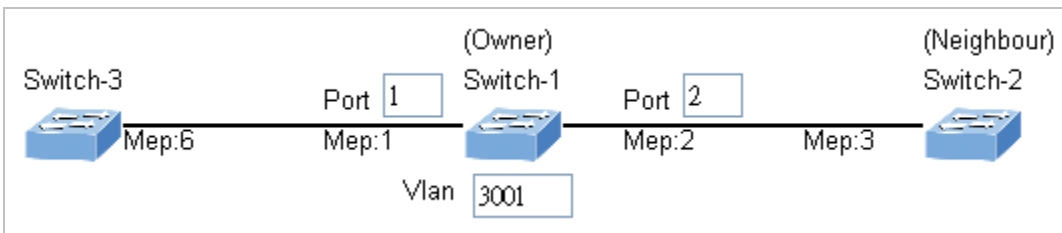

Set ERPS Configuration on Switch 2

Connect PC to switch 2 directly; don't connect to port 1 & 2

Logging on the Switch 2 and click "Ring > Ring Wizard"

Set "All Switch Number" = 3 and "Number ID" = 2; click "Next" button to set the ERPS configuration for Switch 2.

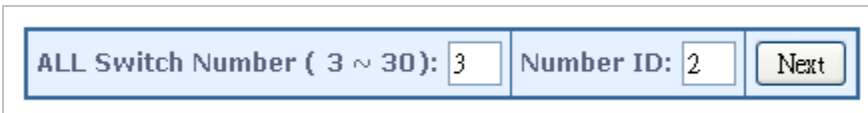

ALL Switch Number (3 ~ 30): Number ID:

Set "MEP3" = Port2, "MEP4" = Port1 and VLAN ID = 3001; click "Set" button to save the ERPS configuration for Switch 2.

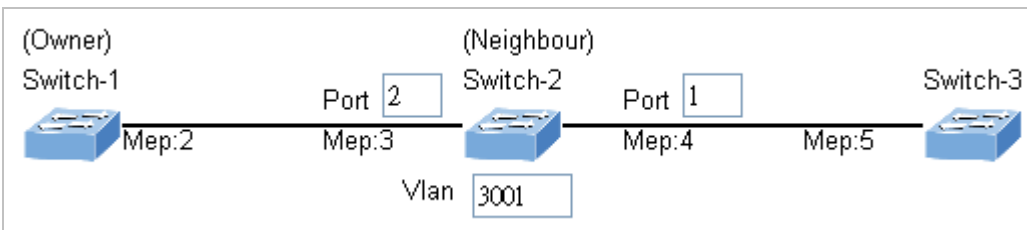

Set ERPS Configuration on Switch 3

Connect PC to switch 3 directly; don't connect to port 1 & 2

Logging on the Switch 3 and click "Ring > Ring Wizard"

Set "All Switch Number" = 3 and "Number ID" = 3; click "Next" button to set the ERPS configuration for Switch 3.

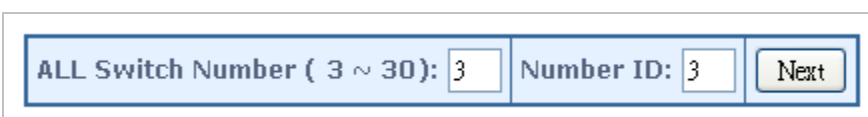

ALL Switch Number (3 ~ 30): Number ID:

Set "MEP5" = Port2, "MEP6" = Port1 and VLAN ID = 3001; click "Set" button to save the ERPS configuration for Switch 3.

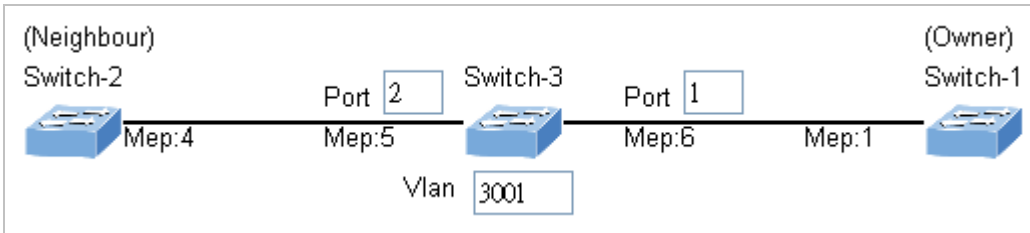

To avoid loop, please don't connect switch 1, 2 & 3 together in the ring topology before configuring the end of ERPS .

Follow the configuration or ERPS wizard to connect the Switch 1, 2 and 3 together to establish ERPS application:

MEP2 ↔ MEP3 = Switch1 / Port2 ↔ Switch2 / Port2

MEP4 ↔ MEP5 = Switch2 / Port1 ↔ Switch3 / Port2

MEP1 ↔ MEP6 = Switch1 / Port1 ↔ Switch3 / Port1.

4.8 ONVIF

4.8.1 ONVIF

ONVIF (Open Network Video Interface Forum) is a global and open industry forum with the goal of facilitating the development and use of a global open standard for the interface of physical IP-based security products – or, in other words, to create a standard for how IP products within video surveillance and other physical security areas can communicate with each other. The ONVIF specification aims to achieve interoperability between network video products regardless of manufacturer.

4.8.1.1 ONVIF Device Search

Entries in the ONVIF Devices Table are shown on this page. The ONVIF Devices Table can sorted first by VLAN ID, Model, MAC Address then by IP Address. The ONVIF Devices Table screen in [Figure 4-8-1-1](#) appears.

ONVIF Device Search

Query by:

| | | |
|--------------------------------------|--|--|
| <input type="checkbox"/> VLAN | | |
| <input type="checkbox"/> Model | | |
| <input type="checkbox"/> MAC Address | | |
| <input type="checkbox"/> IP Address | | |

Please click "Search" to query or update the current list

| Port | Device Type | Device Name | Manufacturer | Model | IP address | MAC address | VLAN | Select Device |
|------|-------------|-------------|--------------|----------|---------------|-------------------|------|--------------------------|
| 16 | IP camera | ICA-3250 | PLANET | ICA-3250 | 192.168.0.127 | 00-30-4F-BB-9A-4E | 1 | <input type="checkbox"/> |

Auto Search

Please Select the ONVIF Device and click "Apply" for adding into "ONVIF Device List"

Figure 4-8-1-1: ONVIF Devices Table Status Page Screenshot

Navigating the ONVIF Devices Table

The "Start from MAC address" and "VLAN", "Model", "MAC Address" and "IP Address" input fields allow the user to select the starting point in the ONVIF Devices Table. Clicking the "Refresh" button will update the displayed table which is match from ONVIF Devices Table.

The page includes the following fields:

| Object | Description |
|---------------|---|
| • Port | This is the logical port number for this row. |
| • Device Type | The ONVIF Device's Type of the entry. |

| | |
|------------------------|--|
| • Device Name | The ONVIF Device's Name of the entry. |
| • Manufacturer | The ONVIF Device's Manufacturer of the entry. |
| • Model | The ONVIF Device's Model Name of the entry. |
| • IP Address | The ONVIF Device's IP Address of the entry. |
| • MAC Address | The ONVIF Device's MAC address of the entry. |
| • VLAN | The ONVIF Device's VLAN ID of the entry. |
| • Select Device | Allows to tick for selecting ONVIF Devices for adding into ONVIF List Table. |

Buttons

- : Click to search the connecting ONVIF devices.
- : Click to apply changes
- : Click to undo any changes made locally and revert to previously saved values.

Auto-search Automatic search occurs every 60 seconds.

4.8.1.2 ONVIF Device List

This page provides an overview of ONVIF Device entries. Each page shows up to 10 entries from the ONVIF Device List table, default being 10, selected through the "entries per page" input field. When first visited, the web page will show the first 10 entries from the beginning of the ONVIF Device List table; screen in [Figure 4-8-1-2](#) appears.

ONVIF Device List

Query by:

Login(Optional)

Please click "Refresh" to query or update the current list

1

0

ONVIF Camera(s) online ONVIF Camera(s) offline

entries per page.

| Port | Status | Device Type | Device Name | Manufacturer | Model | IP address | MAC address | Power Used[W] | Action |
|------|---|-------------|-------------|--------------|----------|---------------|-------------------|---------------|---|
| 16 | ● | IP camera | ICA-3250 | PLANET | ICA-3250 | 192.168.0.127 | 00-30-4F-BB-9A-4E | 5.4 | <input type="button" value="↻"/> <input type="button" value="🔗"/> <input type="button" value="🗑️"/> |

Auto Refresh

Figure 4-8-1-2: ONVIF Device List Page Screenshot

The page includes the following fields:

| Object | Description |
|--------------------------|--|
| • Login(Optional) | Allows for filling one set of User name and Password. |
| • Port | This is the logical port number for this row. |
| • Status | Red: The ONVIF device is not active. Green: The ONVIF device is active.The ONVIF Device's Type of the entry. |
| • Device Type | The ONVIF Device's Type of the entry. |
| • Device Name | The ONVIF Device's Name of the entry. |
| • Manufacturer | The ONVIF Device's Manufacturer of the entry. |
| • Model | The ONVIF Device's Model Name of the entry. |
| • IP Address | The ONVIF Device's IP Address of the entry. |
| • MAC Address | The ONVIF Device's MAC address of the entry. |
| • Power Used [W] | The Power Used shows how much power the ONVIF device currently is using. |
| • Action | There are three actions: Access: Clicks for accessing into the ONVIF device's WEBUI. Reboot: Clicks for rebooting the ONVIF device. Delete: Clicks for deleting the ONVIF device from ONVIF Device List. |

Buttons

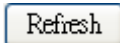
: Click to refresh the page immediately.

Auto-refresh Check this box to refresh the page automatically. Automatic refresh occurs every 30 seconds.

: Updates the ONVIF device entries, press to the first page.

: Updates the ONVIF device entries, press to the front page.

: Updates the ONVIF device entries, press to the next page.

: Updates the ONVIF device entries, press to the final page.

4.8.1.3 MAP Upload / Edit

This page allows the clients for uploading e-MAP, the file size can not over 151k; screen in [Figure 4-8-1-3](#) appears.

Upload Map

| | |
|---------------------|---|
| MAP Select | MAP1 ▼ |
| Description: | asd |
| File size: | 28521Byte |
| File: | <input type="button" value="Choose File"/> No file chosen |

Preview Map
Current Map

Figure 4-8-1-3: Map Upload / Edit Page Screenshot

The page includes the following fields:

| Object | Description |
|----------------------|---|
| • MAP Select | Allows to select Map1/2/3 for uploading Map. |
| • Description | Indicates the map's description. |
| • File size | Shows Map's size. |
| • File | Allows to choose and browse specific map file from laptop device. |
| • Preview Map | The Preview use of Map. |
| • Current Map | The Current use of Map. |

Buttons

: Click to choose the file.

: Click to upload the file.

4.8.1.4 Floor Map

This page allows the clients for planning the ONVIF devices with the uploaded e-Map. It can select the ONVIF devices from Device List and it also can modify the e-Map's Zoom and Scale; screen in [Figure 4-8-1-4](#) appears.

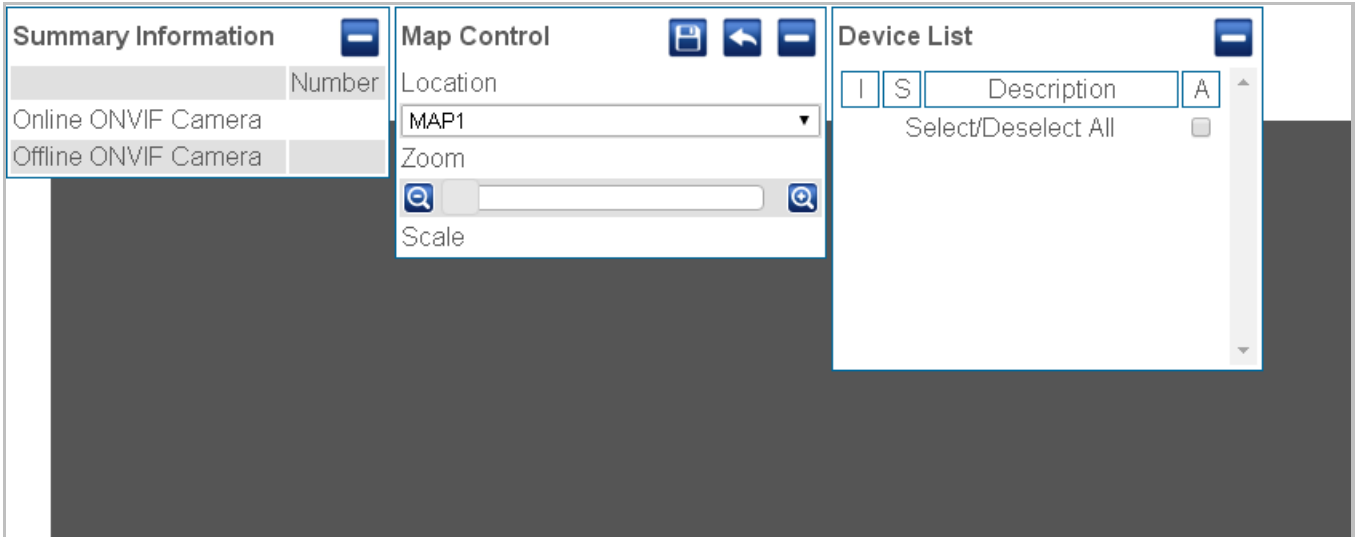

Figure 4-8-1-4: Floor Map Page Screenshot

The page includes the following fields:

| Object | Description |
|--|---|
| <ul style="list-style-type: none"> • Summary Information | Shows the number of Online and Offline ONVIF cameras. |
| <ul style="list-style-type: none"> • Map Control | Allows to choose Location of Map1/2/3 and zoom in/out of Map. |
| <ul style="list-style-type: none"> • Device List | Allows to select ONVIF devices. |

4.9 Maintenance

4.9.1 Switch Maintenance

This chapter is teaching how to upgrade the firmware, how to save the switch running configure and how to download/upload the configure file and etc.

4.9.1.1 Web Firmware Upgrade

This page facilitates an update of the firmware controlling the switch. The Web Firmware Upgrade screen in [Figure 4-9-1-1](#) appears.



Figure 4-9-1-1: Web Firmware Upgrade Page Screenshot

To open **Firmware Upgrade** screen, perform the following:

1. Click **Maintenance** -> **Web Firmware Upgrade**.
2. The Firmware Upgrade screen is displayed as in [Figure 4-9-1-1](#)
3. Click the "**Choose File**" button of the Main page; the system would pop up the file selection menu to choose firmware.
4. Select on the firmware and then click "**Upload**". The **Software Upload Progress** would show the file with upload status.
5. Once the software is loaded to the system successfully, the following screen appears. The system will load the new software after reboot.

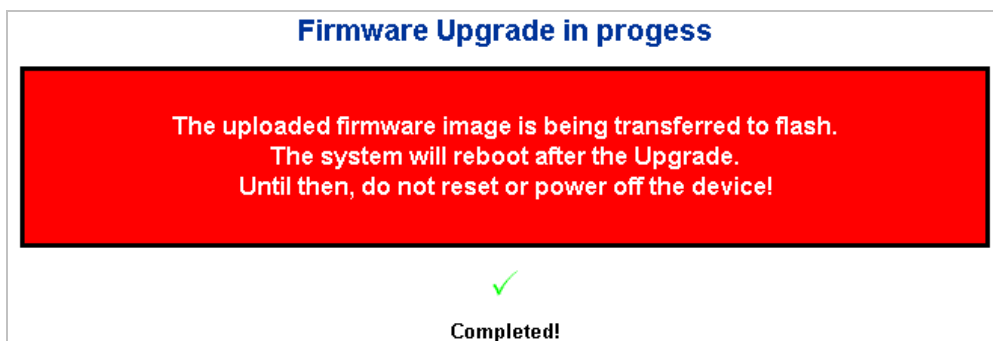

Figure 4-9-1-2: Software Successfully Loaded Notice Screen



DO NOT Power OFF the **Industrial Managed Switch** until the update progress is complete.



Do not quit the Firmware Upgrade page without pressing the “**OK**” button after the image is loaded. Or the system won't apply the new firmware. User has to repeat the firmware upgrade processes.

4.9.1.2 Save Startup Config

This function allows to save the current configuration, thereby ensuring that the current active configuration can be used at the next reboot as the screen in [Figure 4-9-1-3](#) appears. After saving the configuration, the screen in [Figure 4-9-1-4](#) will appear.



Figure 4-9-1-3: Configuration Save Page Screenshot



Figure 4-9-1-4: Finish Saving Page Screenshot

4.9.1.3 Configuration Download

The switch stores its configuration in a number of text files in CLI format. The files are either virtual (RAM-based) or stored in flash on the switch.

There are three system files:

- running-config: A virtual file that represents the currently active configuration on the switch. This file is volatile.
- startup-config: The startup configuration for the switch, read at boot time.
- default-config: A read-only file with vendor-specific configuration. This file is read when the system is restored to default settings.

It is also possible to store up to two other files and apply them to running-config, thereby switching configuration.

Configuration Download page allows the download the running-config, startup-config and default-config on the switch. Please refer to the [Figure 4-9-1-5](#) shown below.

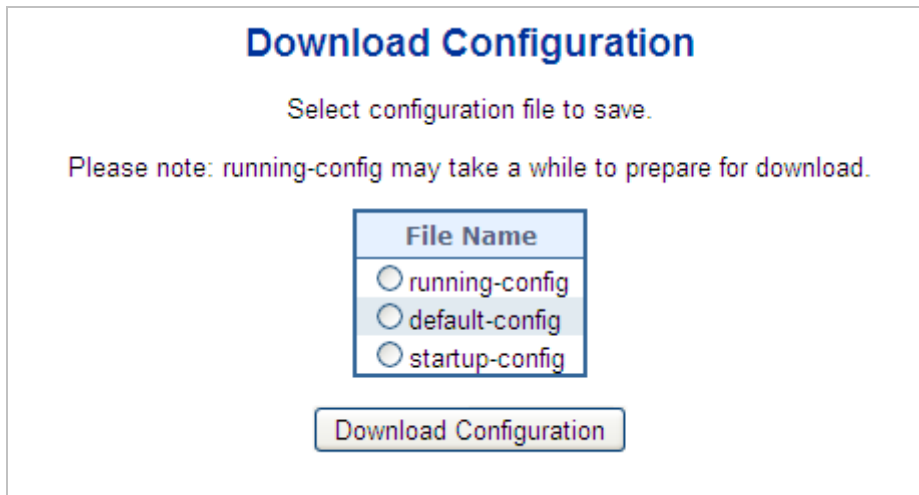

Figure 4-9-1-5: Configuration Download Page Screenshot

4.9.1.4 Configuration Upload

Configuration Upload page allows the upload the running-config and startup-config on the switch. Please refer to the Figure 4-9-1-6 shown below.

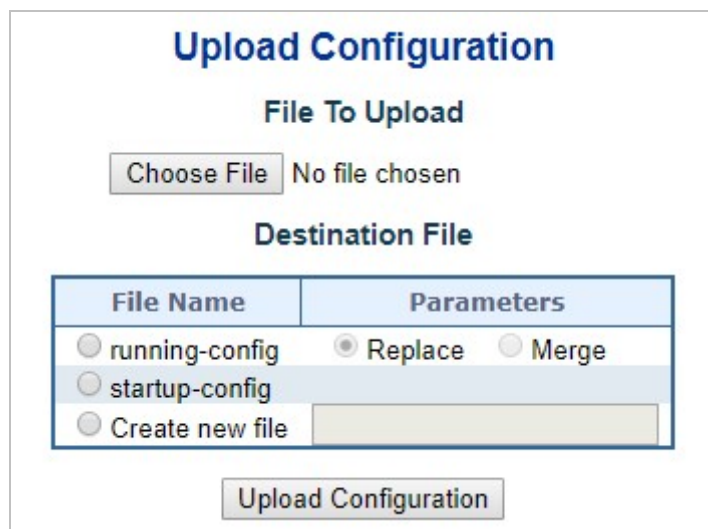

Figure 4-9-1-6: Configuration Upload Page Screenshot

If the destination is running-config, the file will be applied to the switch configuration. This can be done in two ways:

- Replace mode: The current configuration is fully replaced with the configuration in the uploaded file.
- Merge mode: The uploaded file is merged into *running-config*.

If the file system is full (i.e. contains the three system files mentioned above plus two other files), it is not possible to create new files, but an existing file must be overwritten or another deleted first.

4.9.1.5 Configuration Activate

The Configure Activate page allows to activate the startup-config and default-config files present on the switch. Please refer to

the Figure 4-9-1-7 shown below.

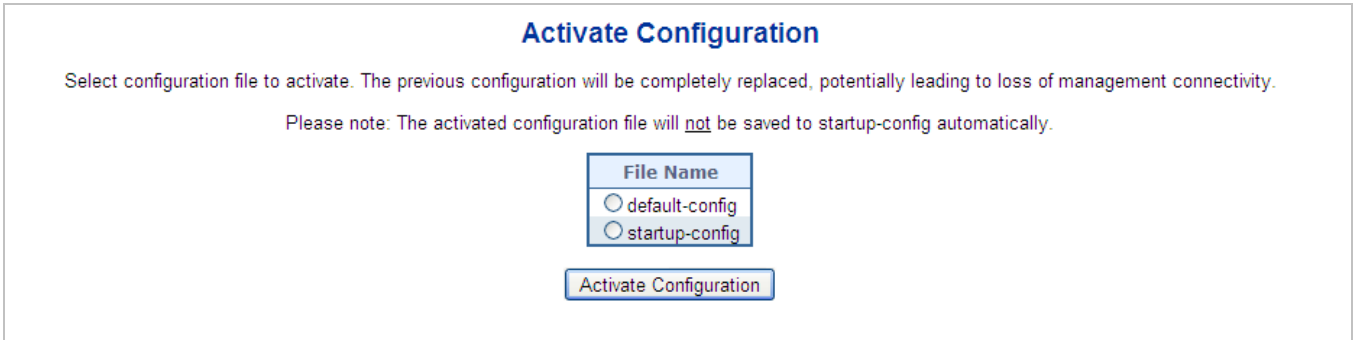



Figure 4-9-1-7: Configuration Activate Page Screenshot

It is possible to activate any of the configuration files present on the switch, except for *running-config* which represents the currently active configuration.

Select the file to activate and click . This will initiate the process of completely replacing the existing configuration with that of the selected file.

4.9.1.6 Configuration Delete

The Configure Delete page allows to delete the startup-config and default-config files which are stored in FLASH. If this is done and the switch is rebooted without a prior Save operation, this effectively resets the switch to default configuration. Please refer to the Figure 4-9-1-8 shown below.

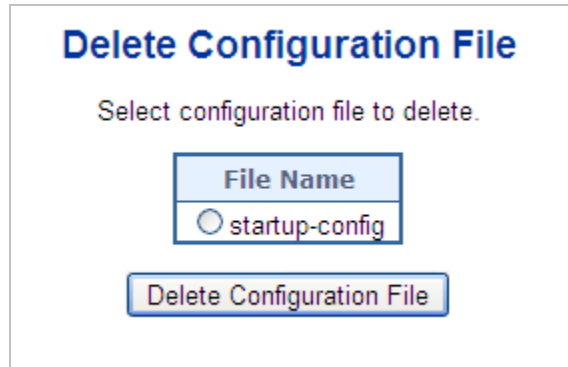

Figure 4-9-1-8: Configuration Delete Page Screenshot

4.9.1.7 Image Select

This page provides information about the active and alternate (backup) firmware images in the device, and allows you to revert to the alternate image. The web page displays two tables with information about the active and alternate firmware images. The Image Select screen in [Figure 4-9-1-9](#) appears.



In case the active firmware image is the alternate image, only the "Active Image" table is shown. In this case, the Activate Alternate Image button is also disabled.



1. If the alternate image is active (due to a corruption of the primary image or by manual intervention), uploading a new firmware image to the device will automatically use the primary image slot and activate this.
2. The firmware version and date information may be empty for older firmware releases. This does not constitute an error.

Software Image Selection

| Active Image | |
|----------------|---------------------------|
| Image | managed |
| Version | 1.440180704 |
| Date | 2018-07-05T11:49:46+08:00 |

| Alternate Image | |
|-----------------|---------------------------|
| Image | managed.bk |
| Version | 1.440180704 |
| Date | 2018-07-05T11:49:46+08:00 |

Activate Alternate Image

Figure 4-9-1-9: Software Image Selection Page Screenshot

The page includes the following fields:

| Object | Description |
|------------------|--|
| • Image | The flash index name of the firmware image. The name of primary (preferred) image is image, the alternate image is named image.bk. |
| • Version | The version of the firmware image. |
| • Date | The date when the firmware was produced. |

Buttons

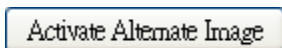

Click to use the alternate image. This button may be disabled depending on system state.

4.9.1.8 Factory Default

You can reset the configuration of the **Industrial Managed Switch** on this page. Only the IP configuration is retained. The new configuration is available immediately, which means that no restart is necessary. The Factory Default screen in [Figure 4-9-1-10](#)

appears.

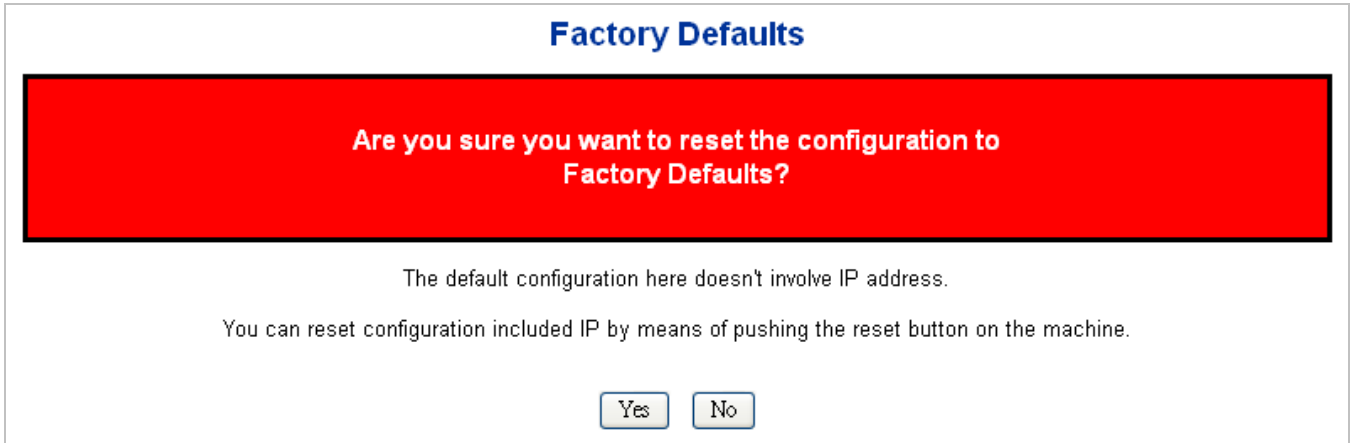



Figure 4-9-1-10: Factory Default Page Screenshot

Buttons

: Click to reset the configuration to Factory Defaults.

: Click to return to the Port State page without resetting the configuration.



To reset the **Industrial Managed Switch** to the Factory default setting, you can also press the hardware reset button at the front panel about 10 seconds. After the device is rebooted, you can login the management Web interface within the same subnet of 192.168.0.xx.

4.9.1.9 Configuration Download

The **Reboot** page enables the device to be rebooted from a remote location. Once the Reboot button is pressed, user has to re-login the Web interface about 60 seconds later; the System Reboot screen in [Figure 4-9-1-11](#) appears.

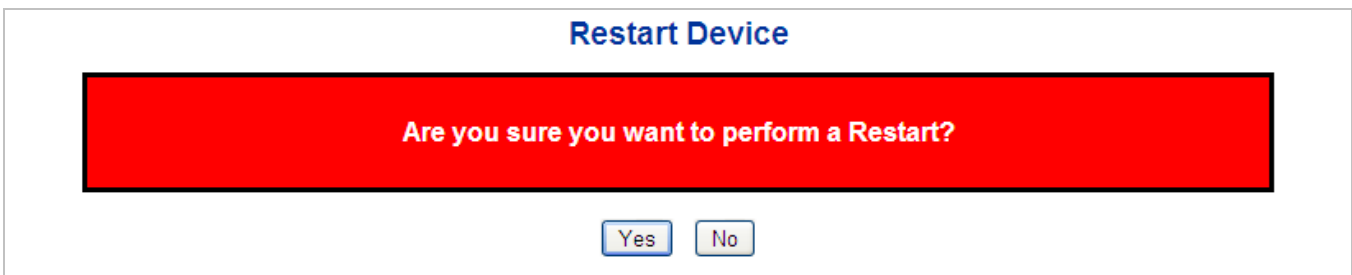



Figure 4-9-1-11: System Reboot Page Screenshot

Buttons

: Click to reboot the system.

: Click to return to the Port State page without rebooting the system.



You can also check the **SYS LED** on the front panel to identify whether the System is loaded completely or not. If the SYS LED is blinking, then it is in the firmware load stage; if the SYS LED light is on, you can use the Web browser to login the **Industrial Managed Switch**.

4.9.2 Diagnostics

This section provide the Physical layer and IP layer network diagnostics tools for troubleshoot. The diagnostic tools are designed for network manager to help them quickly diagnose problems between point to point and better service customers.

Use the Diagnostics menu items to display and configure basic administrative details of the Industrial Managed Switch. Under System the following topics are provided to configure and view the system information:

This section has the following items:

- **Ping**
- **IPv6 Ping**
- **Remote IP Ping**
- **Cable Diagnostics**

Ping

The ping and IPv6 ping allow you to issue ICMP PING packets to troubleshoot IP connectivity issues. The Industrial Managed Switch transmit ICMP packets, and the sequence number and roundtrip time are displayed upon reception of a reply.

Cable Diagnostics

The Cable Diagnostics performing tests on copper cables. These functions have the ability to identify the cable length and operating conditions, and to isolate a variety of common faults that can occur on the Cat5 twisted-pair cabling. There might be two statuses as follow:

- If the link is established on the twisted-pair interface in 1000BASE-T mode, the Cable Diagnostics can run without disruption of the link or of any data transfer.
- If the link is established in 100BASE-TX or 10BASE-T, the Cable Diagnostics cause the link to drop while the diagnostics are running.

After the diagnostics are finished, the link is reestablished. And the following functions are available.

- Coupling between cable pairs.
- Cable pair termination
- Cable Length

4.9.2.1 Ping

This page allows you to issue ICMP PING packets to troubleshoot IP connectivity issues.

After you press “**Start**”, 5 ICMP packets are transmitted, and the sequence number and roundtrip time are displayed upon reception of a reply. The page refreshes automatically until responses to all packets are received, or until a timeout occurs. The ICMP Ping screen in [Figure 4-9-2-1](#) appears.

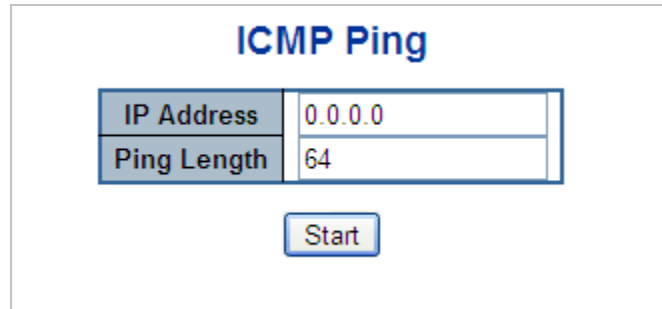
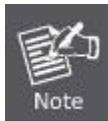

Figure 4-9-2-1: ICMP Ping Page Screenshot

The page includes the following fields:

| Object | Description |
|--|---|
| <ul style="list-style-type: none"> • IP Address | The destination IP Address. |
| <ul style="list-style-type: none"> • Ping Length | The payload size of the ICMP packet. Values range from 2 bytes to 1452 bytes. |



Be sure the target IP Address is within the same network subnet of the **Industrial Managed Switch**, or you had setup the correct gateway IP address.

Buttons



: Click to transmit ICMP packets.

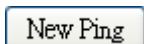

: Click to re-start diagnostics with PING.

4.9.2.2 IPv6 Ping

This page allows you to issue ICMPv6 PING packets to troubleshoot IPv6 connectivity issues.

After you press “**Start**”, 5 ICMPv6 packets are transmitted, and the sequence number and roundtrip time are displayed upon reception of a reply. The page refreshes automatically until responses to all packets are received, or until a timeout occurs. The ICMPv6 Ping screen in [Figure 4-9-2-2](#) appears.

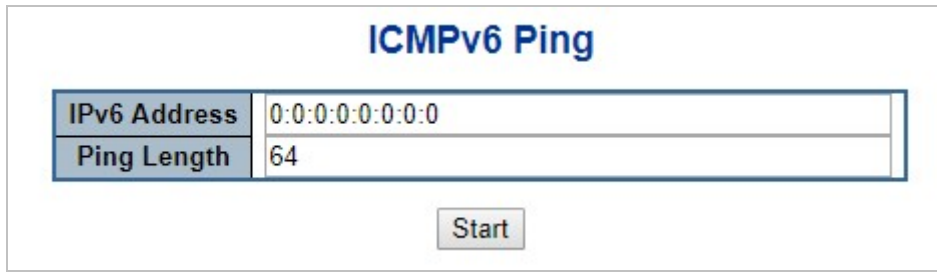

Figure 4-9-2-2: ICMPv6 Ping Page Screenshot

The page includes the following fields:

| Object | Description |
|--|---|
| <ul style="list-style-type: none"> • IP Address | The destination IP Address. |
| <ul style="list-style-type: none"> • Ping Length | The payload size of the ICMP packet. Values range from 2 bytes to 1452 bytes. |

Buttons

Start: Click to transmit ICMP packets.

New Ping: Click to re-start diagnostics with PING.

4.9.2.3 Remote IP Ping Test

This page allows you to issue ICMP PING packets to troubleshoot IP connectivity issues on special port.

After you press “**Test**”, 5 ICMP packets are transmitted, and the sequence number and roundtrip time are displayed upon reception of a reply. The page refreshes automatically until responses to all packets are received, or until a timeout occurs. The ICMP Ping screen in [Figure 4-9-2-3](#) appears.

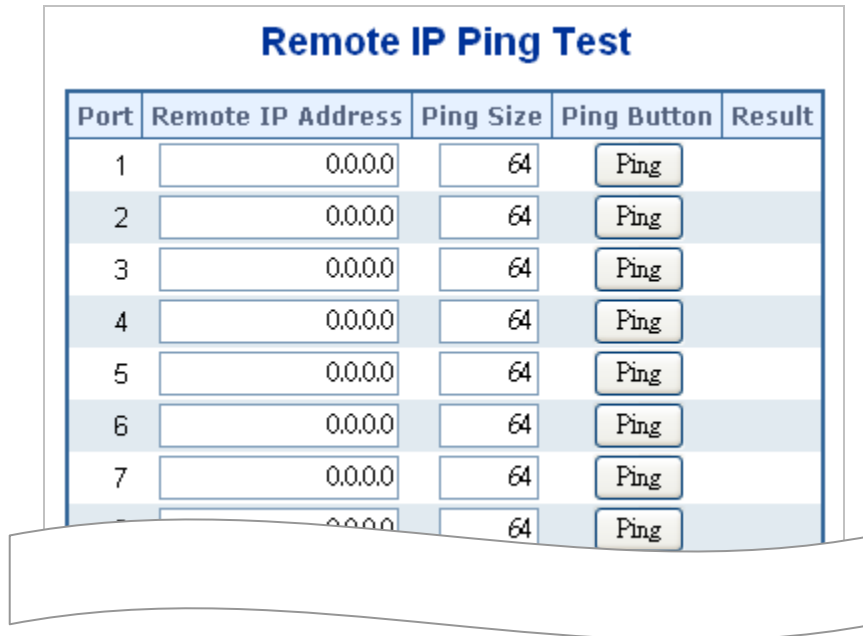

Figure 4-9-2-3: Remote IP Ping Test Page Screenshot

The page includes the following fields:

| Object | Description |
|---------------------|---|
| • Port | The logical port for the settings. |
| • Remote IP Address | The destination IP Address. |
| • Ping Size | The payload size of the ICMP packet. Values range from 8 bytes to 1400 bytes. |
| • Result | Display the ping result. |

Buttons



: Click to apply changes



: Click to undo any changes made locally and revert to previously saved values.



: Clears the IP Address and the result of ping value.

4.9.2.4 Cable Diagnostics

This page is used for running the Cable Diagnostics.

Press to run the diagnostics. This will take approximately 5 seconds. If all ports are selected, this can take approximately 15 seconds. When completed, the page refreshes automatically, and you can view the cable diagnostics results in the cable status table. Note that Cable Diagnostics is only accurate for cables of length 7 - 140 meters.

10 and 100 Mbps ports will be linked down while running cable diagnostic. Therefore, running cable diagnostic on a 10 or 100 Mbps management port will cause the switch to stop responding until VeriPHY is complete. The VeriPHY Cable Diagnostics screen in [Figure 4-9-2-4](#) appears.

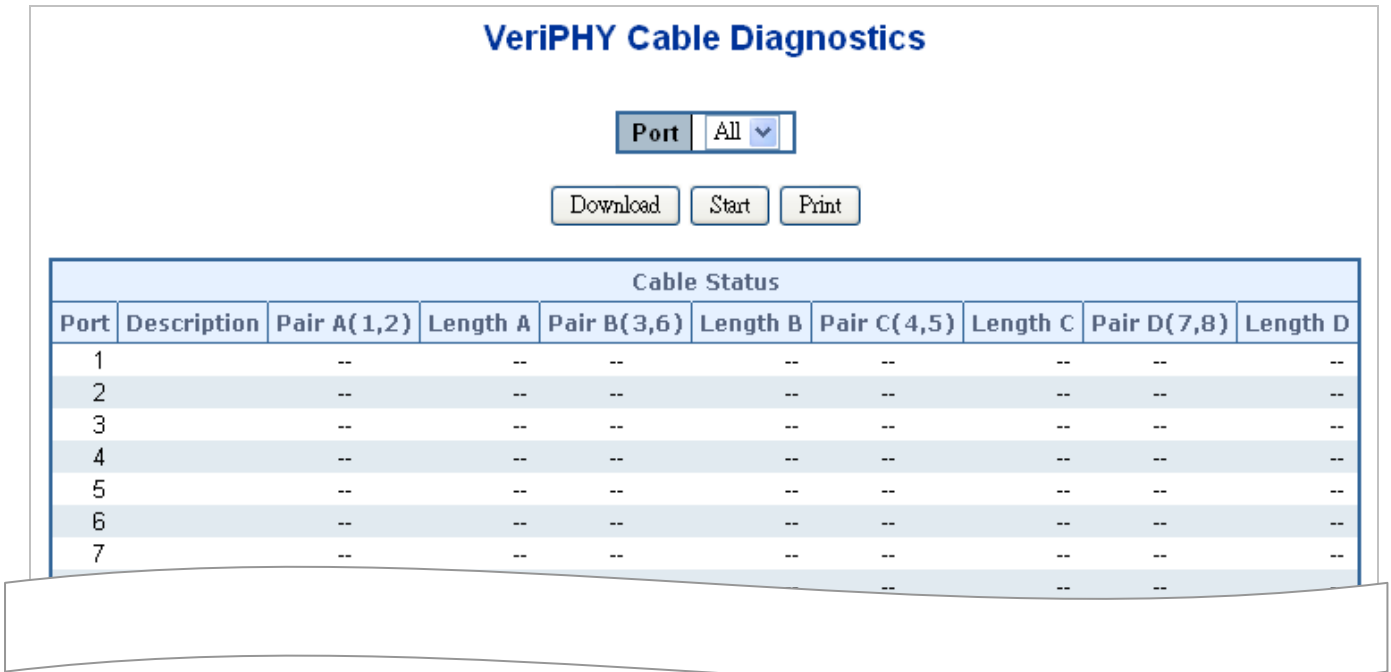

Figure 4-9-2-4 VeriPHY Cable Diagnostics Page Screenshot

The page includes the following fields:

| Object | Description |
|-----------------------|--|
| • Port | The port where you are requesting Cable Diagnostics. |
| • Description | Display per port description. |
| • Cable Status | <p>Port: Port number.</p> <p>Pair: The status of the cable pair.</p> <p>OK - Correctly terminated pair</p> <p>Open - Open pair</p> <p>Short - Shorted pair</p> <p>Short A - Cross-pair short to pair A</p> <p>Short B - Cross-pair short to pair B</p> <p>Short C - Cross-pair short to pair C</p> <p>Short D - Cross-pair short to pair D</p> <p>Cross A - Abnormal cross-pair coupling with pair A</p> |

| | |
|--|---|
| | <p>Cross B - Abnormal cross-pair coupling with pair B</p> <p>Cross C - Abnormal cross-pair coupling with pair C</p> <p>Cross D - Abnormal cross-pair coupling with pair D</p> <p>Length: The length (in meters) of the cable pair. The resolution is 3 meters</p> |
|--|---|

Buttons



Click to run the diagnostics.

5. SWITCH OPERATION

5.1 Address Table

The **Industrial Managed Switch** is implemented with an address table. This address table is composed of many entries. Each entry is used to store the address information of some nodes in the network, including MAC address, port no, etc. This information comes from the learning process of **Industrial Managed Switch**.

5.2 Learning

When one packet comes in from any port, the **Industrial Managed Switch** will record the source address, port no., and the other related information in address table. This information will be used to decide either forwarding or filtering for future packets.

5.3 Forwarding & Filtering

When one packet comes from some port of the **Industrial Managed Switch**, it will also check the destination address besides the source address learning. The **Industrial Managed Switch** will look up the address-table for the destination address. If not found, this packet will be forwarded to all the other ports except the port, which this packet comes in. And these ports will transmit this packet to the network it connected. If found, and the destination address is located at a different port from this packet comes in, the **Industrial Managed Switch** will forward this packet to the port where this destination address is located according to the information from address table. But, if the destination address is located at the same port with this packet comes in, then this packet will be filtered, thereby increasing the network throughput and availability.

5.4 Store-and-Forward

Store-and-Forward is one type of packet-forwarding techniques. A Store-and-Forward **Industrial Managed Switch** stores the incoming frame in an internal buffer and do the complete error checking before transmission. Therefore, no error packets occur; it is the best choice when a network needs efficiency and stability.

The **Industrial Managed Switch** scans the destination address from the packet-header, searches the routing table provided for the incoming port and forwards the packet, only if required. The fast forwarding makes the switch attractive for connecting servers directly to the network, thereby increasing throughput and availability. However, the switch is most commonly used to segment existence hubs, which nearly always improves the overall performance. An Ethernet switching can be easily configured in any Ethernet network environment to significantly boost bandwidth using the conventional cabling and adapters.

Due to the learning function of the **Industrial Managed Switch**, the source address and corresponding port number of each incoming and outgoing packet are stored in a routing table. This information is subsequently used to filter packets whose destination address is in the same segment as the source address. This confines network traffic to its respective domain and reduce the overall load on the network.

The **Industrial Managed Switch** performs "**Store and Fforward**"; therefore, no error packets occur. More reliably, it reduces the re-transmission rate. No packet loss will occur.

5.5 Auto-Negotiation

The STP ports on the Switch have built-in "**Auto-negotiation**". This technology automatically sets the best possible bandwidth when a connection is established with another network device (usually at Power On or Reset). This is done by detecting the modes and speeds both connected devices are capable of. Both 10BASE-T and 100BASE-TX devices can connect with the port in either half- or full-duplex mode. 1000BASE-T can be only connected in full-duplex mode.

6. TROUBLESHOOTING

This chapter contains information to help you solve issues. If the **Industrial Managed Switch** is not functioning properly, make sure the **Industrial Managed Switch** was set up according to instructions in this manual.

■ The Link LED is not lit.

Solution:

Check the cable connection and remove duplex mode of the **Industrial Managed Switch**.

■ Some stations cannot talk to other stations located on the other port.

Solution:

Please check the VLAN settings, trunk settings, or port enabled/disabled status.

■ Performance is bad.

Solution:

Check the full duplex status of the **Industrial Managed Switch**. If the **Industrial Managed Switch** is set to full duplex and the partner is set to half duplex, then the performance will be poor. Please also check the in/out rate of the port.

■ Why the Switch doesn't connect to the network.

Solution:

1. Check the LNK/ACT LED on the switch.
2. Try another port on the Switch.
3. Make sure the cable is installed properly.
4. Make sure the cable is the right type.
5. Turn off the power. After a while, turn on power again.

■ 100BASE-T port link LED is lit, but the traffic is irregular.

Solution:

Check that the attached device is not set to dedicate full duplex. Some devices use a physical or software switch to change duplex modes. Auto-negotiation may not recognize this type of full-duplex setting.

■ Switch does not power up.

Solution:

1. AC power cord is not inserted or faulty.
2. Check that the AC power cord is inserted correctly.
3. Replace the power cord if the cord is inserted correctly; check that the AC power source is working by connecting a different device in place of the switch.
4. If that device works, refer to the next step.
5. If that device does not work, check the AC power.

APPENDIX A: Networking Connection

A.1 Switch's Data RJ45 Pin Assignments - 1000Mbps, 1000BASE-T

| PIN NO | MDI | MDI-X |
|--------|--------|--------|
| 1 | BI_DA+ | BI_DB+ |
| 2 | BI_DA- | BI_DB- |
| 3 | BI_DB+ | BI_DA+ |
| 4 | BI_DC+ | BI_DD+ |
| 5 | BI_DC- | BI_DD- |
| 6 | BI_DB- | BI_DA- |
| 7 | BI_DD+ | BI_DC+ |
| 8 | BI_DD- | BI_DC- |

Implicit implementation of the crossover function within a twisted-pair cable, or at a wiring panel, while not expressly forbidden, is beyond the scope of this standard.

A.2 10/100Mbps, 10/100BASE-TX

When connecting your Switch to another Fast Ethernet switch, a bridge or a hub, a straight or crossover cable is necessary. Each port of the Switch supports auto-MDI/MDI-X detection. That means you can directly connect the Switch to any Ethernet devices without making a crossover cable. The following table and diagram show the standard RJ45 receptacle/ connector and their pin assignments:

| RJ45 Connector pin assignment | | |
|-------------------------------|----------------------------------|--|
| PIN NO | MDI Media Dependent Interface | MDI-X Media Dependent Interface-Cross |
| 1 | Tx + (transmit) | Rx + (receive) |
| 2 | Tx - (transmit) | Rx - (receive) |
| 3 | Rx + (receive) | Tx + (transmit) |
| 4, 5 | Not used | |
| 6 | Rx - (receive) | Tx - (transmit) |
| 7, 8 | Not used | |

The standard cable, RJ45 pin assignment

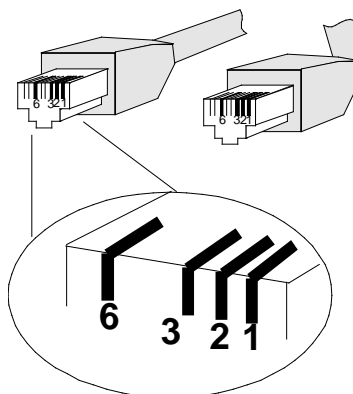

The standard RJ45 receptacle/connector

There are 8 wires on a standard UTP/STP cable and each wire is color-coded. The following shows the pin allocation and color of straight-through cable and crossover cable connection:

| Straight Cable | | SIDE 1 | SIDE 2 | | | | | | | |
|-----------------|---|--------|--------|---|---|---|---|--------|--------------------|--------------------|
| 1 | 2 | 3 | 4 | 5 | 6 | 7 | 8 | SIDE 1 | 1 = White / Orange | 1 = White / Orange |
| 1 | 2 | 3 | 4 | 5 | 6 | 7 | 8 | | 2 = Orange | 2 = Orange |
| 1 | 2 | 3 | 4 | 5 | 6 | 7 | 8 | SIDE 2 | 3 = White / Green | 3 = White / Green |
| 1 | 2 | 3 | 4 | 5 | 6 | 7 | 8 | | 4 = Blue | 4 = Blue |
| 1 | 2 | 3 | 4 | 5 | 6 | 7 | 8 | SIDE 1 | 5 = White / Blue | 5 = White / Blue |
| 1 | 2 | 3 | 4 | 5 | 6 | 7 | 8 | | 6 = Green | 6 = Green |
| 1 | 2 | 3 | 4 | 5 | 6 | 7 | 8 | SIDE 2 | 7 = White / Brown | 7 = White / Brown |
| 1 | 2 | 3 | 4 | 5 | 6 | 7 | 8 | | 8 = Brown | 8 = Brown |
| Crossover Cable | | SIDE 1 | SIDE 2 | | | | | | | |
| 1 | 2 | 3 | 4 | 5 | 6 | 7 | 8 | SIDE 1 | 1 = White / Orange | 1 = White / Green |
| 1 | 2 | 3 | 4 | 5 | 6 | 7 | 8 | | 2 = Orange | 2 = Green |
| 1 | 2 | 3 | 4 | 5 | 6 | 7 | 8 | SIDE 2 | 3 = White / Green | 3 = White / Orange |
| 1 | 2 | 3 | 4 | 5 | 6 | 7 | 8 | | 4 = Blue | 4 = Blue |
| 1 | 2 | 3 | 4 | 5 | 6 | 7 | 8 | SIDE 1 | 5 = White / Blue | 5 = White / Blue |
| 1 | 2 | 3 | 4 | 5 | 6 | 7 | 8 | | 6 = Green | 6 = Orange |
| 1 | 2 | 3 | 4 | 5 | 6 | 7 | 8 | SIDE 2 | 7 = White / Brown | 7 = White / Brown |
| 1 | 2 | 3 | 4 | 5 | 6 | 7 | 8 | | 8 = Brown | 8 = Brown |

Figure A-1: Straight-through and Crossover Cable

Please make sure your connected cables are with the same pin assignment and color as the above picture before deploying the cables into your network.

APPENDIX B : GLOSSARY

A

ACE

ACE is an acronym for **A**ccess **C**ontrol **E**ntry. It describes access permission associated with a particular ACE ID.

There are three ACE frame types (Ethernet Type, ARP, and IPv4) and two ACE actions (permit and deny).

The ACE also contains many detailed, different parameter options that are available for individual application.

ACL

ACL is an acronym for **A**ccess **C**ontrol **L**ist. It is the list table of ACEs, containing access control entries that specify individual users or groups permitted or denied to specific traffic objects, such as a process or a program.

Each accessible traffic object contains an identifier to its ACL. The privileges determine whether there are specific traffic object access rights.

ACL implementations can be quite complex, for example, when the ACEs are prioritized for the various situation. In networking, the ACL refers to a list of service ports or network services that are available on a host or server, each with a list of hosts or servers permitted or denied to use the service. ACL can generally be configured to control inbound traffic, and in this context, they are similar to firewalls.

There are 3 web pages associated with the manual ACL configuration:

ACL|Access Control List: The web page shows the ACEs in a prioritized way, highest (top) to lowest (bottom). Default the table is empty. An ingress frame will only get a hit on one ACE even though there are more matching ACEs. The first matching ACE will take action (permit/deny) on that frame and a counter associated with that ACE is incremented. An ACE can be associated with a policy, 1 ingress port, or any ingress port (the whole switch). If an ACE Policy is created then that policy can be associated with a group of ports under the "Ports" web page. There are number of parameters that can be configured with an ACE. Read the web page help text to get further information for each of them. The maximum number of ACEs is 64.

ACL|Ports: The ACL Port configuration is used to assign a Policy ID to an ingress port. This is useful to group ports to obey the same traffic rules. Traffic Policy is created under the "Access Control List". You can you also set up specific traffic properties (Action / Rate Limiter / Port copy, etc) for each ingress port. They will though only apply if the frame gets past the ACE matching without getting matched. In that case a counter associated with that port is incremented. See the web page help text for each specific port property.

ACL|Rate Limiters: On this page, you can configure the rate limiters. There can be 15 different rate limiters, each ranging from 1 to 1024K packets per second. Under "Ports" and "Access Control List", you can assign a Rate Limiter ID to the ACE(s) or ingress port(s).

AES

AES is an acronym for **A**dvanced **E**ncryption **S**tandard. The encryption key protocol is applied in 802.1x standard to improve WLAN security. It is an encryption standard by the U.S. government, which will replace DES and 3DES. AES has a fixed block size of 128 bits and a key size of 128, 192, or 256 bits.

AMS

AMS is an acronym for **A**uto **M**edia **S**elect. AMS is used for dual media ports (ports supporting both copper (cu) and fiber (SFP) cables. AMS automatically determines if an SFP or a CU cable is inserted and switches to the corresponding media. If both SFP and cu cables are inserted, the port will select the preferred media.

APS

APS is an acronym for **A**utomatic **P**rotection **S**witching. This protocol is used to secure switching that is done bidirectional in both ends of a protection group, as defined in G.8031.

Aggregation

Using multiple ports in parallel to increase the link speed beyond the limits of a port and to increase the redundancy for higher availability.

(Also *Port Aggregation, Link Aggregation*).

ARP

ARP is an acronym for **A**ddress **R**esolution **P**rotocol. It is a protocol that used to convert an IP address into a physical address, such as an Ethernet address. ARP allows a host to communicate with other hosts when only the Internet address of its neighbors is known. Before using IP, the host sends a broadcast ARP request containing the Internet address of the desired destination system.

ARP Inspection

ARP Inspection is a secure feature. Several types of attacks can be launched against a host or devices connected to Layer 2 networks by "poisoning" the ARP caches. This feature is used to block such attacks. Only valid ARP requests and responses can go through the switch device.

Auto-Negotiation

Auto-negotiation is the process where two different devices establish the mode of operation and the speed settings that can be shared by those devices for a link.

C

CC

CC is an acronym for Continuity Check. It is a MEP functionality that is able to detect loss of continuity in a network by transmitting CCM frames to a peer MEP.

CCM

CCM is an acronym for Continuity Check Message. It is a OAM frame transmitted from a MEP to its peer MEP and used to implement CC functionality.

CDP

CDP is an acronym for Cisco Discovery Protocol.

D

DEI

DEI is an acronym for Drop Eligible Indicator. It is a 1-bit field in the VLAN tag.

DES

DES is an acronym for Data Encryption Standard. It provides a complete description of a mathematical algorithm for encrypting (enciphering) and decrypting (deciphering) binary coded information.

Encrypting data converts it to an unintelligible form called cipher. Decrypting cipher converts the data back to its original form called plaintext. The algorithm described in this standard specifies both enciphering and deciphering operations which are based on a binary number called a key.

DHCP

DHCP is an acronym for Dynamic Host Configuration Protocol. It is a protocol used for assigning dynamic IP addresses to devices on a network.

DHCP used by networked computers (clients) to obtain IP addresses and other parameters such as the default gateway, subnet mask, and IP addresses of DNS servers from a DHCP server.

The DHCP server ensures that all IP addresses are unique, for example, no IP address is assigned to a second client while the first client's assignment is valid (its lease has not expired). Therefore, IP address pool management is done by the server and not by a human network administrator.

Dynamic addressing simplifies network administration because the software keeps track of IP addresses rather than requiring an administrator to manage the task. This means that a new computer can be added to a network without the hassle of manually assigning it a unique IP address.

DHCP Relay

DHCP Relay is used to forward and to transfer DHCP messages between the clients and the server when they are not on the same subnet domain.

The DHCP option 82 enables a DHCP relay agent to insert specific information into a DHCP request packets when forwarding client DHCP packets to a DHCP server and remove the specific information from a DHCP reply packets when forwarding server DHCP packets to a DHCP client. The DHCP server can use this information to implement IP address or other assignment policies. Specifically the option works by setting two sub-options: Circuit ID (option 1) and Remote ID (option2). The Circuit ID sub-option is supposed to include information specific to which circuit the request came in on. The Remote ID sub-option was designed to carry information relating to the remote host end of the circuit.

The definition of Circuit ID in the switch is 4 bytes in length and the format is "vlan_id" "module_id" "port_no". The parameter of "vlan_id" is the first two bytes represent the VLAN ID. The parameter of "module_id" is the third byte for the module ID. The parameter of "port_no" is the fourth byte and it means the port number. The Remote ID is 6 bytes in length, and the value is equal the DHCP relay agents MAC address.

DHCP Snooping

DHCP Snooping is used to block intruder on the untrusted ports of the switch device when it tries to intervene by injecting a bogus DHCP reply packet to a legitimate conversation between the DHCP client and server.

DNS

DNS is an acronym for **D**omain **N**ame **S**ystem. It stores and associates many types of information with domain names. Most importantly, DNS translates human-friendly domain names and computer hostnames into computer-friendly IP addresses. For example, the domain name www.example.com might translate to 192.168.0.1.

DoS

DoS is an acronym for **D**enial of **S**ervice. In a denial-of-service (DoS) attack, an attacker attempts to prevent legitimate users from accessing information or services. By targeting at network sites or network connection, an attacker may be able to prevent network users from accessing email, web sites, online accounts (banking, etc.), or other services that rely on the affected computer.

Dotted Decimal Notation

Dotted Decimal Notation refers to a method of writing IP addresses using decimal numbers and dots as separators between octets.

An IPv4 dotted decimal address has the form x.y.z.w, where x, y, z, and w are decimal numbers between 0 and 255.

DSCP

DSCP is an acronym for **D**ifferentiated **S**ervices **C**ode **P**oint. It is a field in the header of IP packets for packet classification purposes.

E

EEE

EEE is an abbreviation for Energy Efficient Ethernet defined in IEEE 802.3az.

EPS

EPS is an abbreviation for Ethernet Protection Switching defined in ITU/T G.8031.

Ethernet Type

Ethernet Type, or EtherType, is a field in the Ethernet MAC header, defined by the Ethernet networking standard. It is used to indicate which protocol is being transported in an Ethernet frame.

F

FTP

FTP is an acronym for **F**ile **T**ransfer **P**rotocol. It is a transfer protocol that uses the Transmission Control Protocol (TCP) and provides file writing and reading. It also provides directory service and security features.

Fast Leave

IGMP snooping Fast Leave processing allows the switch to remove an interface from the forwarding-table entry without first sending out group specific queries to the interface. The VLAN interface is pruned from the multicast tree for the multicast group specified in the original leave message. Fast-leave processing ensures optimal bandwidth management for all hosts on a switched network, even when multiple multicast groups are in use simultaneously.

H

HTTP

HTTP is an acronym for **H**ypertext **T**ransfer **P**rotocol. It is a protocol that used to transfer or convey information on the World Wide Web (WWW).

HTTP defines how messages are formatted and transmitted, and what actions Web servers and browsers should take in response to various commands. For example, when you enter a URL in your browser, this actually sends an HTTP command to the Web server directing it to fetch and transmit the requested web page. The other main standard that controls how the World Wide Web works is HTML, which covers how web pages are formatted and displayed.

Any Web server machine contains, in addition to the web page files it can serve, an HTTP daemon, a program that is designed to wait for HTTP requests and handle them when they arrive. The Web browser is an HTTP client, sending requests to server machines. An HTTP client initiates a request by establishing a

Transmission Control Protocol (TCP) connection to a particular port on a remote host (port 80 by default). An HTTP server listening on that port waits for the client to send a request message.

HTTPS

HTTPS is an acronym for **H**ypertext **T**ransfer **P**rotocol over **S**ecure Socket Layer. It is used to indicate a secure HTTP connection.

HTTPS provide authentication and encrypted communication and is widely used on the World Wide Web for security-sensitive communication such as payment transactions and corporate logons.

HTTPS is really just the use of Netscape's Secure Socket Layer (SSL) as a sublayer under its regular HTTP application layering. (HTTPS uses port 443 instead of HTTP port 80 in its interactions with the lower layer, TCP/IP.) SSL uses a 40-bit key size for the RC4 stream encryption algorithm, which is considered an adequate degree of encryption for commercial exchange.

I

ICMP

ICMP is an acronym for **I**nternet **C**ontrol **M**essage **P**rotocol. It is a protocol that generated the error response, diagnostic or routing purposes. ICMP messages generally contain information about routing difficulties or simple exchanges such as time-stamp or echo transactions. For example, the PING command uses ICMP to test an Internet connection.

IEEE 802.1X

IEEE 802.1X is an IEEE standard for port-based Network Access Control. It provides authentication to devices attached to a LAN port, establishing a point-to-point connection or preventing access from that port if authentication fails. With 802.1X, access to all switch ports can be centrally controlled from a server, which means that authorized users can use the same credentials for authentication from any point within the network.

IGMP

IGMP is an acronym for **I**nternet **G**roup **M**anagement **P**rotocol. It is a communications protocol used to manage the membership of Internet Protocol multicast groups. IGMP is used by IP hosts and adjacent multicast routers to establish multicast group memberships. It is an integral part of the IP multicast specification, like ICMP for unicast connections. IGMP can be used for online video and gaming, and allows more efficient use of resources when supporting these uses.

IGMP Querier

A router sends IGMP Query messages onto a particular link. This router is called the Querier.

IMAP

IMAP is an acronym for **I**nternet **M**essage **A**ccess **P**rotocol. It is a protocol for email clients to retrieve email messages from a mail server.

IMAP is the protocol that IMAP clients use to communicate with the servers, and SMTP is the protocol used to transport mail to an IMAP server.

The current version of the Internet Message Access Protocol is IMAP4. It is similar to Post Office Protocol version 3 (POP3), but offers additional and more complex features. For example, the IMAP4 protocol leaves your email messages on the server rather than downloading them to your computer. If you wish to remove your messages from the server, you must use your mail client to generate local folders, copy messages to your local hard drive, and then delete and expunge the messages from the server.

IP

IP is an acronym for **I**nternet **P**rotocol. It is a protocol used for communicating data across a internet network.

IP is a "best effort" system, which means that no packet of information sent over it is assured to reach its destination in the same condition it was sent. Each device connected to a Local Area Network (LAN) or Wide Area Network (WAN) is given an Internet Protocol address, and this IP address is used to identify the device uniquely among all other devices connected to the extended network.

The current version of the Internet protocol is IPv4, which has 32-bits Internet Protocol addresses allowing for in excess of four billion unique addresses. This number is reduced drastically by the practice of webmasters taking addresses in large blocks, the bulk of which remain unused. There is a rather substantial movement to adopt a new version of the Internet Protocol, IPv6, which would have 128-bits Internet Protocol addresses. This number can be represented roughly by a three with thirty-nine zeroes after it. However, IPv4 is still the protocol of choice for most of the Internet.

IPMC

IPMC is an acronym for **IP M**ulti**C**ast.

IP Source Guard

IP Source Guard is a secure feature used to restrict IP traffic on DHCP snooping untrusted ports by filtering traffic based on the DHCP Snooping Table or manually configured IP Source Bindings. It helps prevent IP spoofing attacks when a host tries to spoof and use the IP address of another host.

L

LACP

LACP is an IEEE 802.3ad standard protocol. The **L**ink **A**ggregation **C**ontrol **P**rotocol allows bundling several physical ports together to form a single logical port.

LLDP

LLDP is an IEEE 802.1ab standard protocol.

The **L**ink **L**ayer **D**iscovery **P**rotocol(LLDP) specified in this standard allows stations attached to an IEEE 802 LAN to advertise, to other stations attached to the same IEEE 802 LAN, the major capabilities provided by the system

incorporating that station, the management address or addresses of the entity or entities that provide management of those capabilities, and the identification of the stations point of attachment to the IEEE 802 LAN required by those management entities. The information distributed via this protocol is stored by its recipients in a standard Management Information Base (MIB), making it possible for the information to be accessed by a Network Management System (NMS) using a management protocol such as the Simple Network Management Protocol (SNMP).

LLDP-MED

LLDP-MED is an extension of IEEE 802.1ab and is defined by the telecommunication industry association (TIA-1057).

LOC

LOC is an acronym for Loss Of Connectivity and is detected by a MEP and is indicating lost connectivity in the network. Can be used as a switch criteria by EPS

M

MAC Table

Switching of frames is based upon the DMAC address contained in the frame. The switch builds up a table that maps MAC addresses to switch ports for knowing which ports the frames should go to (based upon the DMAC address in the frame). This table contains both static and dynamic entries. The static entries are configured by the network administrator if the administrator wants to do a fixed mapping between the DMAC address and switch ports.

The frames also contain a MAC address (SMAC address), which shows the MAC address of the equipment sending the frame. The SMAC address is used by the switch to automatically update the MAC table with these dynamic MAC addresses. Dynamic entries are removed from the MAC table if no frame with the corresponding SMAC address have been seen after a configurable age time.

MEP

MEP is an acronym for Maintenance Entity Endpoint and is an endpoint in a Maintenance Entity Group (ITU-T Y.1731).

MD5

MD5 is an acronym for Message-Digest algorithm 5. MD5 is a message digest algorithm, used cryptographic hash function with a 128-bit hash value. It was designed by Ron Rivest in 1991. MD5 is officially defined in RFC 1321 - The MD5 Message-Digest Algorithm.

Mirroring

For debugging network problems or monitoring network traffic, the switch system can be configured to mirror frames from multiple ports to a mirror port. (In this context, mirroring a frame is the same as copying the frame.)

Both incoming (source) and outgoing (destination) frames can be mirrored to the mirror port.

MLD

MLD is an acronym for **M**ulticast **L**istener **D**iscovery for IPv6. MLD is used by IPv6 routers to discover multicast listeners on a directly attached link, much as IGMP is used in IPv4. The protocol is embedded in ICMPv6 instead of using a separate protocol.

MVR

Multicast VLAN Registration (MVR) is a protocol for Layer 2 (IP)-networks that enables multicast-traffic from a source VLAN to be shared with subscriber-VLANs. The main reason for using MVR is to save bandwidth by preventing duplicate multicast streams being sent in the core network, instead the stream(s) are received on the MVR-VLAN and forwarded to the VLANs where hosts have requested it/them (Wikipedia).

N

NAS

NAS is an acronym for Network Access Server. The NAS is meant to act as a gateway to guard access to a protected source. A client connects to the NAS, and the NAS connects to another resource asking whether the client's supplied credentials are valid. Based on the answer, the NAS then allows or disallows access to the protected resource. An example of a NAS implementation is IEEE 802.1X.

NetBIOS

NetBIOS is an acronym for **N**etwork **B**asic **I**nput/**O**utput **S**ystem. It is a program that allows applications on separate computers to communicate within a Local Area Network (LAN), and it is not supported on a Wide Area Network (WAN).

The NetBIOS giving each computer in the network both a NetBIOS name and an IP address corresponding to a different host name, provides the session and transport services described in the Open Systems Interconnection (OSI) model.

NFS

NFS is an acronym for **N**etwork **F**ile **S**ystem. It allows hosts to mount partitions on a remote system and use them as though they are local file systems.

NFS allows the system administrator to store resources in a central location on the network, providing authorized users continuous access to them, which means NFS supports sharing of files, printers, and other resources as persistent storage over a computer network.

NTP

NTP is an acronym for **N**etwork **T**ime **P**rotocol, a network protocol for synchronizing the clocks of computer systems. NTP uses UDP (datagrams) as transport layer.

O

OAM

OAM is an acronym for **O**peration **A**dministration and **M**aintenance. It is a protocol described in ITU-T Y.1731 used to implement carrier Ethernet functionality. MEP functionality like CC and RDI is based on this.

Optional TLVs.

An LLDP frame contains multiple TLVs. For some TLVs it is configurable if the switch includes the TLV in the LLDP frame. These TLVs are known as optional TLVs. If an optional TLV is disabled the corresponding information is not included in the LLDP frame.

OUI

OUI is the organizationally unique identifier. An OUI address is a globally unique identifier assigned to a vendor by IEEE. You can determine which vendor a device belongs to according to the OUI address which forms the first 24 bits of an MAC address.

P

PCP

PCP is an acronym for Priority Code Point. It is a 3-bit field storing the priority level for the 802.1Q frame. It is also known as User Priority.

PD

PD is an acronym for **P**owered **D**evice. In a PoE system the power is delivered from a PSE (power sourcing equipment) to a remote device. The remote device is called a PD.

PHY

PHY is an abbreviation for Physical Interface Transceiver and is the device that implement the Ethernet physical layer (IEEE-802.3).

PING

Ping is a program that sends a series of packets over a network or the Internet to a specific computer in order to generate a response from that computer. The other computer responds with an acknowledgment that it received the packets. Ping was created to verify whether a specific computer on a network or the Internet exists and is connected.

Ping uses Internet Control Message Protocol (ICMP) packets. The Ping Request is the packet from the origin computer, and the Ping Reply is the packet response from the target.

Policer

A policer can limit the bandwidth of received frames. It is located in front of the ingress queue.

POP3

POP3 is an acronym for **P**ost **O**ffice **P**rotocol version 3. It is a protocol for email clients to retrieve email messages from a mail server.

POP3 is designed to delete mail on the server as soon as the user has downloaded it. However, some implementations allow users or an administrator to specify that mail be saved for some period of time. POP can be thought of as a "store-and-forward" service.

An alternative protocol is Internet Message Access Protocol (IMAP). IMAP provides the user with more capabilities for retaining e-mail on the server and for organizing it in folders on the server. IMAP can be thought of as a remote file server.

POP and IMAP deal with the receiving of e-mail and are not to be confused with the Simple Mail Transfer Protocol (SMTP). You send e-mail with SMTP, and a mail handler receives it on your recipient's behalf. Then the mail is read using POP or IMAP. IMAP4 and POP3 are the two most prevalent Internet standard protocols for e-mail retrieval. Virtually all modern e-mail clients and servers support both.

PPPoE

PPPoE is an acronym for Point-to-Point Protocol over Ethernet. It is a network protocol for encapsulating Point-to-Point Protocol (PPP) frames inside Ethernet frames. It is used mainly with ADSL services where individual users connect to the ADSL transceiver (modem) over Ethernet and in plain Metro Ethernet networks (Wikipedia).

Private VLAN

In a private VLAN, communication between ports in that private VLAN is not permitted. A VLAN can be configured as a private VLAN.

PTP

PTP is an acronym for Precision Time Protocol, a network protocol for synchronizing the clocks of computer systems.

Q

QCE

QCE is an acronym for **Q**oS **C**ontrol **E**ntry. It describes QoS class associated with a particular QCE ID.

There are six QCE frame types: Ethernet Type, VLAN, UDP/TCP Port, DSCP, TOS, and Tag Priority. Frames can be classified by one of 4 different QoS classes: "Low", "Normal", "Medium", and "High" for individual application.

QCL

QCL is an acronym for **Q**oS **C**ontrol **L**ist. It is the list table of QCEs, containing QoS control entries that classify to a specific QoS class on specific traffic objects.

Each accessible traffic object contains an identifier to its QCL. The privileges determine specific traffic object to specific QoS class.

QL

QL In SyncE this is the Quality Level of a given clock source. This is received on a port in a SSM indicating the quality of the clock received in the port.

QoS

QoS is an acronym for **Q**uality **o**f **S**ervice. It is a method to guarantee a bandwidth relationship between individual applications or protocols.

A communications network transports a multitude of applications and data, including high-quality video and delay-sensitive data such as real-time voice. Networks must provide secure, predictable, measurable, and sometimes guaranteed services.

Achieving the required QoS becomes the secret to a successful end-to-end business solution. Therefore, QoS is the set of techniques to manage network resources.

QoS class

Every incoming frame is classified to a QoS class, which is used throughout the device for providing queuing, scheduling and congestion control guarantees to the frame according to what was configured for that specific QoS class. There is a one to one mapping between QoS class, queue and priority. A QoS class of 0 (zero) has the lowest priority.

R

RARP

RARP is an acronym for **R**everse **A**ddress **R**esolution **P**rotocol. It is a protocol that is used to obtain an IP address for a given hardware address, such as an Ethernet address. RARP is the complement of ARP.

RADIUS

RADIUS is an acronym for **R**emote **A**uthentication **D**ial In **U**ser **S**ervice. It is a networking protocol that provides centralized access, authorization and accounting management for people or computers to connect and use a network service.

RDI

RDI is an acronym for **R**emote **D**efect **I**ndication. It is an OAM functionality that is used by a MEP to indicate defect detected to the remote peer MEP

Router Port

A router port is a port on the Ethernet switch that leads switch towards the Layer 3 multicast device.

RSTP

In 1998, the IEEE with document 802.1w introduced an evolution of STP: the **R**apid **S**panning **T**ree **P**rotocol, which provides for faster spanning tree convergence after a topology change. Standard IEEE 802.1D-2004 now incorporates RSTP and obsoletes STP, while at the same time being backwards-compatible with STP.

S

SAMBA

Samba is a program running under UNIX-like operating systems that provides seamless integration between UNIX and Microsoft Windows machines. Samba acts as file and print servers for Microsoft Windows, IBM OS/2, and other SMB client machines. Samba uses the Server Message Block (SMB) protocol and Common Internet File System (CIFS), which is the underlying protocol used in Microsoft Windows networking.

Samba can be installed on a variety of operating system platforms, including Linux, most common Unix platforms, OpenVMS, and IBM OS/2.

Samba can also register itself with the master browser on the network so that it would appear in the listing of hosts in Microsoft Windows "Neighborhood Network".

SHA

SHA is an acronym for **S**ecure **H**ash **A**lgorithm. It designed by the National Security Agency (NSA) and published by the NIST as a U.S. Federal Information Processing Standard. Hash algorithms compute a fixed-length digital representation (known as a message digest) of an input data sequence (the message) of any length.

Shaper

A shaper can limit the bandwidth of transmitted frames. It is located after the ingress queues.

SMTP

SMTP is an acronym for **S**imple **M**ail **T**ransfer **P**rotocol. It is a text-based protocol that uses the Transmission Control Protocol (TCP) and provides a mail service modeled on the FTP file transfer service. SMTP transfers mail messages between systems and notifications regarding incoming mail.

SNAP

The SubNetwork Access Protocol (SNAP) is a mechanism for multiplexing, on networks using IEEE 802.2 LLC, more protocols than can be distinguished by the 8-bit 802.2 Service Access Point (SAP) fields. SNAP supports identifying protocols by Ethernet type field values; it also supports vendor-private protocol identifier.

SNMP

SNMP is an acronym for **S**imple **N**etwork **M**anagement **P**rotocol. It is part of the Transmission Control Protocol/Internet Protocol (TCP/IP) protocol for network management. SNMP allow diverse network objects to participate in a network management architecture. It enables network management systems to learn network problems by receiving traps or change notices from network devices implementing SNMP.

SNTP

SNTP is an acronym for **S**imple **N**etwork **T**ime **P**rotocol, a network protocol for synchronizing the clocks of computer systems. SNTP uses UDP (datagrams) as transport layer.

SPROUT

Stack **P**rotocol using **R**outing **T**echnology. An advanced protocol for almost instantaneous discovery of topology changes within a stack as well as election of a master switch. SPROUT also calculates parameters for setting up each switch to perform shortest path forwarding within the stack.

SSID

Service **S**et **I**dentifier is a name used to identify the particular 802.11 wireless LANs to which a user wants to attach. A client device will receive broadcast messages from all access points within range advertising their SSIDs, and can choose one to connect to based on pre-configuration, or by displaying a list of SSIDs in range and asking the user to select one (wikipedia).

SSH

SSH is an acronym for **S**ecure **S**hell. It is a network protocol that allows data to be exchanged using a secure channel between two networked devices. The encryption used by SSH provides confidentiality and integrity of data over an insecure network. The goal of SSH was to replace the earlier rlogin, TELNET and rsh protocols, which did not provide strong authentication or guarantee confidentiality (Wikipedia).

SSM

SSM In SyncE this is an abbreviation for Synchronization Status Message and is containing a QL indication.

STP

Spanning **T**ree **P**rotocol is an OSI layer-2 protocol which ensures a loop free topology for any bridged LAN. The original STP protocol is now obsolete by RSTP.

SyncE

SyncE Is an abbreviation for Synchronous Ethernet. This functionality is used to make a network 'clock frequency' synchronized. Not to be confused with real time clock synchronized (IEEE 1588).

T

TACACS+

TACACS+ is an acronym for **T**erminal **A**ccess **C**ontroller **A**ccess **C**ontrol **S**ystem **P**lus. It is a networking protocol which provides access control for routers, network access servers and other networked computing devices via one or more centralized servers. TACACS+ provides separate authentication, authorization and accounting services.

Tag Priority

Tag Priority is a 3-bit field storing the priority level for the 802.1Q frame.

TCP

TCP is an acronym for **T**ransmission **C**ontrol **P**rotocol. It is a communications protocol that uses the Internet Protocol (IP) to exchange the messages between computers.

The TCP protocol guarantees reliable and in-order delivery of data from sender to receiver and distinguishes data for multiple connections by concurrent applications (for example, Web server and e-mail server) running on the same host.

The applications on networked hosts can use TCP to create connections to one another. It is known as a connection-oriented protocol, which means that a connection is established and maintained until such time as the message or messages to be exchanged by the application programs at each end have been exchanged. TCP is responsible for ensuring that a message is divided into the packets that IP manages and for reassembling the packets back into the complete message at the other end.

Common network applications that use TCP include the World Wide Web (WWW), e-mail, and File Transfer Protocol (FTP).

TELNET

TELNET is an acronym for **T**eletype **N**etwork. It is a terminal emulation protocol that uses the Transmission Control Protocol (TCP) and provides a virtual connection between TELNET server and TELNET client.

TELNET enables the client to control the server and communicate with other servers on the network. To start a Telnet session, the client user must log in to a server by entering a valid username and password. Then, the client user can enter commands through the Telnet program just as if they were entering commands directly on the server console.

TFTP

TFTP is an acronym for **T**rivial **F**ile **T**ransfer **P**rotocol. It is transfer protocol that uses the User Datagram Protocol (UDP) and provides file writing and reading, but it does not provides directory service and security features.

Toss

Toss is an acronym for **T**ype **o**f **S**ervice. It is implemented as the IPv4 Toss priority control. It is fully decoded to determine the priority from the 6-bit Toss field in the IP header. The most significant 6 bits of the Toss field are fully decoded into 64 possibilities, and the singular code that results is compared against the corresponding bit in the IPv4 ToS priority control bit (0~63).

TLV

TLV is an acronym for **T**ype **L**ength **V**alue. A LLDP frame can contain multiple pieces of information. Each of these pieces of information is known as TLV.

TKIP

TKIP is an acronym for **T**emporal **K**ey **I**ntegrity **P**rotocol. It used in WPA to replace WEP with a new encryption algorithm. TKIP comprises the same encryption engine and RC4 algorithm defined for WEP. The key used for encryption in TKIP is 128 bits and changes the key used for each packet.

U

UDP

UDP is an acronym for **U**ser **D**atagram **P**rotocol. It is a communications protocol that uses the Internet Protocol (IP) to exchange the messages between computers.

UDP is an alternative to the Transmission Control Protocol (TCP) that uses the Internet Protocol (IP). Unlike TCP, UDP does not provide the service of dividing a message into packet datagrams, and UDP doesn't provide reassembling and sequencing of the packets. This means that the application program that uses UDP must be able to make sure that the entire message has arrived and is in the right order. Network applications that want to save processing time because they have very small data units to exchange may prefer UDP to TCP.

UDP provides two services not provided by the IP layer. It provides port numbers to help distinguish different user requests and, optionally, a checksum capability to verify that the data arrived intact.

Common network applications that use UDP include the Domain Name System (DNS), streaming media applications such as IPTV, Voice over IP (VoIP), and Trivial File Transfer Protocol (TFTP).

UPnP

UPnP is an acronym for **U**niversal **P**lug and **P**lay. The goals of UPnP are to allow devices to connect seamlessly and to simplify the implementation of networks in the home (data sharing, communications, and entertainment) and in corporate environments for simplified installation of computer components

User Priority

User Priority is a 3-bit field storing the priority level for the 802.1Q frame.

V

VLAN

A method to restrict communication between switch ports. VLANs can be used for the following applications:

VLAN unaware switching: This is the default configuration. All ports are VLAN unaware with Port VLAN ID 1 and members of VLAN 1. This means that MAC addresses are learned in VLAN 1, and the switch does not remove or insert VLAN tags.

VLAN aware switching: This is based on the IEEE 802.1Q standard. All ports are VLAN aware. Ports connected to VLAN aware switches are members of multiple VLANs and transmit tagged frames. Other ports are members of one VLAN, set up with this Port VLAN ID, and transmit untagged frames.

Provider switching: This is also known as Q-in-Q switching. Ports connected to subscribers are VLAN unaware, members of one VLAN, and set up with this unique Port VLAN ID. Ports connected to the service provider are VLAN aware, members of multiple VLANs, and set up to tag all frames. Untagged frames

received on a subscriber port are forwarded to the provider port with a single VLAN tag. Tagged frames received on a subscriber port are forwarded to the provider port with a double VLAN tag.

VLAN ID

VLAN ID is a 12-bit field specifying the VLAN to which the frame belongs.

Voice VLAN

Voice VLAN is VLAN configured specially for voice traffic. By adding the ports with voice devices attached to voice VLAN, we can perform QoS-related configuration for voice data, ensuring the transmission priority of voice traffic and voice quality.

W

WEP

WEP is an acronym for **W**ired **E**quivalent **P**rivacy. WEP is a deprecated algorithm to secure IEEE 802.11 wireless networks. Wireless networks broadcast messages using radio, so are more susceptible to eavesdropping than wired networks. When introduced in 1999, WEP was intended to provide confidentiality comparable to that of a traditional wired network (Wikipedia).

Wi-Fi

Wi-Fi is an acronym for **W**ireless **F**idelity. It is meant to be used generically when referring of any type of 802.11 network, whether 802.11b, 802.11a, dual-band, etc. The term is promulgated by the Wi-Fi Alliance.

WPA

WPA is an acronym for **W**i-Fi **P**rotected **A**ccess. It was created in response to several serious weaknesses researchers had found in the previous system, Wired Equivalent Privacy (WEP). WPA implements the majority of the IEEE 802.11i standard, and was intended as an intermediate measure to take the place of WEP while 802.11i was prepared. WPA is specifically designed to also work with pre-WPA wireless network interface cards (through firmware upgrades), but not necessarily with first generation wireless access points. WPA2 implements the full standard, but will not work with some older network cards (Wikipedia).

WPA-PSK

WPA-PSK is an acronym for **W**i-Fi **P**rotected **A**ccess - **P**re **S**hared **K**ey. WPA was designed to enhance the security of wireless networks. There are two flavors of WPA: enterprise and personal. Enterprise is meant for use with an IEEE 802.1X authentication server, which distributes different keys to each user. Personal WPA utilizes less scalable 'pre-shared key' (PSK) mode, where every allowed computer is given the same passphrase. In PSK mode, security depends on the strength and secrecy of the passphrase. The design of WPA is based on a Draft 3 of the IEEE 802.11i standard (Wikipedia)

WPA-Radius

WPA-Radius is an acronym for **W**i-Fi **P**rotected **A**ccess - Radius (802.1X authentication server). WPA was designed to enhance the security of wireless networks. There are two flavors of WPA: enterprise and personal. Enterprise is meant for use with an IEEE 802.1X authentication server, which distributes different keys to each user. Personal WPA utilizes

less scalable 'pre-shared key' (PSK) mode, where every allowed computer is given the same passphrase. In PSK mode, security depends on the strength and secrecy of the passphrase. The design of WPA is based on a Draft 3 of the IEEE 802.11i standard (Wikipedia)

WPS

WPS is an acronym for **W**i-Fi **P**rotected **S**etup. It is a standard for easy and secure establishment of a wireless home network. The goal of the WPS protocol is to simplify the process of connecting any home device to the wireless network (Wikipedia).

WRED

WRED is an acronym for **W**eighted **R**andom **E**arly **D**etection. It is an active queue management mechanism that provides preferential treatment of higher priority frames when traffic builds up within a queue. A frame's DP level is used as input to WRED. A higher DP level assigned to a frame results in a higher probability that the frame is dropped during times of congestion.

WTR

WTR is an acronym for **W**ait **T**o **R**estore. This is the time a fail on a resource has to be 'not active' before restoration back to this (previously failing) resource is done.