

User's Manual

Layer 3 24-Port 10G SFP+ + 4-Port 100G QSFP28 Managed Switch



▶ XGS-6350-24X4C



Trademarks

Copyright © PLANET Technology Corp. 2019.

Contents are subject to revision without prior notice.

PLANET is a registered trademark of PLANET Technology Corp. All other trademarks belong to their respective owners.

Disclaimer

PLANET Technology does not warrant that the hardware will work properly in all environments and applications, and makes no warranty and representation, either implied or expressed, with respect to the quality, performance, merchantability, or fitness for a particular purpose. PLANET has made every effort to ensure that this User's Manual is accurate; PLANET disclaims liability for any inaccuracies or omissions that may have occurred.

Information in this User's Manual is subject to change without notice and does not represent a commitment on the part of PLANET. PLANET assumes no responsibility for any inaccuracies that may be contained in this User's Manual. PLANET makes no commitment to update or keep current the information in this User's Manual, and reserves the right to make improvements to this User's Manual and/or to the products described in this User's Manual, at any time without notice.

If you find information in this manual that is incorrect, misleading, or incomplete, we would appreciate your comments and suggestions.

FCC Warning

This equipment has been tested and found to comply with the limits for a Class A digital device, pursuant to Part 15 of the FCC Rules. These limits are designed to provide reasonable protection against harmful interference when the equipment is operated in a commercial environment. This equipment generates, uses, and can radiate radio frequency energy and, if not installed and used in accordance with the Instruction manual, may cause harmful interference to radio communications. Operation of this equipment in a residential area is likely to cause harmful interference in which case the user will be required to correct the interference at his own expense.

CE Mark Warning

This is a Class A product. In a domestic environment, this product may cause radio interference, in which case the user may be required to take adequate measures.

Energy Saving Note of the Device

This power required device does not support Standby mode operation. For energy saving, please remove the power cable to disconnect the device from the power circuit. In view of saving the energy and reducing the unnecessary power consumption, it is strongly suggested to remove the power connection for the device if this device is not intended to be active.

WEEE Warning



To avoid the potential effects on the environment and human health as a result of the presence of hazardous substances in electrical and electronic equipment, end users of electrical and electronic equipment should understand the meaning of the crossed-out wheeled bin symbol. Do not dispose of WEEE as unsorted municipal waste and have to collect such WEEE separately.

Revision

PLANET Layer 3 24-Port 10G SFP+ + 4-Port 100G QSFP28 Managed Switch User's Manual

FOR MODEL: XGS-6350-24X4C

REVISION: 1.0 (October, 2019)

Part No: EM-XGS-6350-24X4C

Contents

Chapter 1.	INTRODUCTION	18
1.1	Packet Contents.....	18
1.2	Product Features	21
1.3	Product Specifications	24
Chapter 2.	INSTALLATION	29
2.1	Hardware Description	29
2.1.1	Switch Front Panel.....	29
2.1.2	LED Indications.....	30
2.1.3	Switch Rear Panel	30
2.2	Installing the Managed Switch	31
2.2.1	Desktop Installation	31
2.2.2	Rack Mounting.....	31
2.2.3	Installing the SFP/SFP+/QSFP28 100G SFP Transceiver	32
Chapter 3.	Switch Management	36
3.1	Management Options.....	36
3.1.1	Out-Of-Band Management	36
3.1.2	In-band Management.....	40
3.1.3	Help Function.....	46
3.1.4	Canceling a Command	46
3.1.5	Saving Configuration	46
Chapter 4.	Basic Configuration	47
4.1	System Management Configuration.....	47
4.1.1	File Management Configuration.....	47
4.1.2	Basic System Management Configuration.....	51
4.1.3	HTTP Configuration	52
4.2	Terminal Configuration	53
4.2.1	VTY Configuration Introduction.....	53
4.2.2	Configuration Task	53
4.2.3	Monitor and Maintenance	54
4.2.4	VTY Configuration Example.....	54
4.3	Network Management Configuration	54
4.3.1	Configuring SNMP	54
4.3.2	RMON Configuration	61
4.3.3	Configuring PDP	64
4.3.4	Introduction	66
4.3.5	Configuration Tasks	67
4.3.6	SSH server Configuration Example	68

Chapter 5.	Network Management Configuration	69
5.1	Network Management Configuration	69
5.1.1	SNMP Configuration	69
5.1.2	Overview	69
5.1.3	SNMP Notification	69
5.1.4	SNMP Tasks	69
5.2	LLC2 Configuration Task.....	70
5.2.1	Configuring Idle Time Value.....	70
5.2.2	Configuring the Time Value of Waiting for Acknowledgement	70
5.2.3	Configuring Busy Time Value of Remote Terminal.....	71
5.2.4	Configuring Time Value of Response	71
5.2.5	Configuring the Time of Rejection.....	72
5.2.6	Configuring the Retial Times.....	73
5.2.7	Configuring the Size of Window for Resending	73
5.2.8	Configuring the Size of Accumulated Data Packet	74
5.2.9	Setting the Acknowledgement Time-Delay	74
5.2.10	Setting the Maximum Numbers of Acknowledgement	74
5.2.11	Showing LLC2 Link Information	75
5.2.12	Debugging LLC2 Link Information	75
5.2.13	Example of LLC2 Configuration	75
5.2.14	Configuring SDLC as Two-Way and Concurrent Mode	76
5.2.15	Configuring SDLC Timer and Re-Sending Times	76
5.2.16	Configuring the Number of SDLC Frame and Information Frame	77
5.2.17	Controlling the Size of Cache	77
5.2.18	Controlling the polling of slave station	77
5.2.19	Configuring SDLC Interface as Half-Duplex Mode	78
5.2.20	Configuring XID Value.....	78
5.2.21	Configuring the Maximum Value of SDLC Information Frame	78
5.2.22	Monitoring SDLC Workstation.....	79
Chapter 6.	Security Configuration	80
6.1	AAAConfiguration	80
6.1.1	AAA Overview.....	80
6.1.2	AAA Configuration Process	82
6.1.3	AAA Authentication Configuration Task List.....	83
6.1.4	AAA Authentication Configuration Task.....	83
6.1.5	AAA Authentication Configuration Example.....	88
6.1.6	AAA Authorization Configuration Task List.....	88
6.1.7	AAA Authorization Configuration Task	88
6.1.8	AAA Authorization Example	89
6.1.9	AAA Accounting Configuration Task List	90
6.1.10	AA Accounting Configuration Task	90
6.2	Configuring RADIUS	92
6.2.1	Introduction	92
6.2.2	RADIUS Configuration Task List	94
6.2.3	RADIUS Configuration Task List.....	94
6.2.4	RADIUS Configuration Task.....	94
6.2.5	RADIUS Configuration Examples	96

6.3	Web Authentication Configuration.....	97
6.3.1	Overview.....	97
6.3.2	Configuring Web Authentication.....	100
6.3.3	Monitoring and Maintaining Web Authentication.....	102
6.3.4	Web Authentication Configuration Example.....	103
Chapter 7.	Web Configuration	105
7.1	HTTP Switch Configuration.....	105
7.1.1	HTTP Configuration.....	105
7.1.2	HTTPS Configuration.....	106
7.2	Configuration Preparation.....	107
7.2.1	Accessing the Switch through HTTP.....	107
7.2.2	Accessing a Switch through Secure Links.....	108
7.2.3	Introduction of Web Interface.....	108
7.3	Basic Configuration.....	111
7.3.1	Hostname Configuration.....	112
7.3.2	Time Management.....	112
7.4	Configuration of the Physical Interface.....	113
7.4.1	Configuring Port Description.....	113
7.4.2	Configuring the Attributes of the Port.....	114
7.4.3	Rate control.....	114
7.4.4	Port mirroring.....	115
7.4.5	Loopback Detection.....	115
7.4.6	Port security.....	115
7.4.7	Storm control.....	117
7.5	Layer 2 Configuration.....	119
7.5.1	VLAN Settings.....	119
7.5.2	PDP Configuration.....	120
7.5.3	LDP Configuration.....	121
7.5.4	Link Aggregation Configuration.....	122
7.5.5	STP Configuration.....	123
7.5.6	GMP Snooping Configuration.....	124
7.5.7	Setting Static ARP.....	126
7.5.8	Ring Protection Configuration.....	126
7.5.9	DDM Configuration.....	128
7.6	Layer 3 Configuration.....	128
7.6.1	Configuring the VLAN Interface.....	129
7.6.2	Setting the Static Route.....	129
7.6.3	IGMP Proxy.....	130
7.7	Advanced Configuration.....	131
7.7.1	QoS Configuration.....	131
7.7.2	MAC Access Control List.....	132
7.7.3	IP Access Control List.....	133
7.8	Network Management Configuration.....	136
7.8.1	SNMP Configuration.....	136
7.8.2	RMON.....	137
7.9	Diagnosis Tools.....	140
7.9.1	Ping.....	140
7.10	System Management.....	141

7.10.1	User Management	141
7.10.2	Log Management.....	142
7.10.3	Managing the Configuration Files	142
7.10.4	Software Management.....	143
7.10.5	Rebooting the Device	144
Chapter 8.	Interface Configuration	146
8.1	Introduction	146
8.1.1	Supported Interface Types.....	146
8.1.2	Interface Configuration Introduction.....	147
8.2	Interface Configuration.....	148
8.2.1	Configuring Interface Common Attribute.....	148
8.2.2	Monitoring and Maintaining Interface.....	149
8.2.3	Configuring Logistical Interface	150
8.3	Interface Configuration Example.....	152
8.3.1	Configuring Public Attribute of Interface	152
Chapter 9.	Interface Range Configuration	153
9.1	Interface Range Configuration Task.....	153
9.1.1	Understanding Interface Range	153
9.1.2	Entering Interface Range Mode	153
9.1.3	Configuration Example	153
Chapter 10.	Port Physical Characteristics Configuration	154
10.1	Configuring the Ethernet Interface	154
10.1.1	Selecting Ethernet Interface	154
10.1.2	Configuring Rate	154
10.1.3	Configuring Flow Control on the Interface	154
Chapter 11.	Port Additional Characteristics Configuration Interface Configuration	156
11.1	Configuring the Ethernet Interface	156
11.1.1	Configuring Flow Control for the Port	156
11.1.2	Configuring the Rate Unit for the Port.....	156
11.1.3	Configuring the Storm Control on the Port.....	156
11.2	Secure Port Configuration.....	157
11.2.1	Overview	157
11.2.2	Configuration Task of the Secure Port	157
11.3	Configuring the Secure Port.....	157
11.3.1	Configuring the Secure Port Mode	157
11.3.2	Configuring the Static MAC Address of the Secure Port	158
Chapter 12.	Configuring Port Mirroring	159
12.1	Configuring Port Mirroring Task.....	159
12.1.1	Configuring Port Mirroring.....	159

12.1.2	Displaying Port Mirroring Information	159
Chapter 13.	Configuring MAC Address Attribute	160
13.1	MAC Address Configuration Task List.....	160
13.2	MAC address Configuration Task.....	160
13.2.1	Configuring Static Mac Address.....	160
13.2.2	Configuring MAC Address Aging Time.....	160
13.2.3	Displaying MAC Address Table.....	161
13.2.4	Clearing Dynamic MAC Address	161
Chapter 14.	Configuring MAC List	162
14.1	MAC List Configuration Task.....	162
14.1.1	Creating MAC List.....	162
14.1.2	Configuring Items of MAC List.....	162
14.1.3	Applying MAC List	163
Chapter 15.	Configuring 802.1x	164
15.1	802.1x Configuration Task List.....	164
15.2	802.1x Configuration Task.....	164
15.2.1	Configuring 802.1x Port Authentication	164
15.2.2	Configuring 802.1x Multiple Port Authentication	165
15.2.3	Configuring Maximum Times for 802.1x ID Authentication	165
15.2.4	Configuring 802.1x Re-authentication	166
15.2.5	Configuring 802.1x Transmission Frequency	166
15.2.6	Configuring 802.1x User Binding.....	166
15.2.7	Configuring Authentication Method for 802.1x Port	166
15.2.8	Selecting Authentication Type for 802.1x Port	167
15.2.9	Configuring 802.1x Accounting	167
15.2.10	Configuring 802.1x guest-vlan	168
15.2.11	Forbidding Supplicant with Multiple Network Cards	168
15.2.12	Resuming Default 802.1x Configuration	168
15.2.13	Monitoring 802.1x Authentication Configuration and State.....	169
15.3	802.1x Configuration Example.....	169
Chapter 16.	VLAN Configuration	171
16.1	VLAN Introduction.....	171
16.2	VLAN Configuration Task List	171
16.3	VLAN Configuration Task.....	171
16.3.1	Adding/Deleting VLAN	171
16.3.2	Configuring Switch Port	172
16.3.3	Creating/Deleting VLAN Interface.....	173
16.3.4	Configuring Super VLAN Interface	173
16.3.5	Monitoring Configuration and State of VLAN.....	174
16.4	Configuration Examples.....	174

Chapter 17.	GVRP Configuration	175
17.1	Configuring GVRP	175
17.2	Introduction	175
17.3	Configuring Task List.....	175
17.3.1	GVRP Configuration Task List	175
17.4	GVRP Configuration Task	175
17.4.1	Enabling/Disabling GVRP Globally	175
17.4.2	Enabling/Disabling GVRP on the Interface	175
17.4.3	Monitoring and Maintenance of GVRP	176
17.5	Configuration Example.....	176
Chapter 18.	Private VLAN Settings	178
18.1	Private VLAN Settings	178
18.2	Overview of Private VLAN	178
18.3	Private VLAN Type and Port Type in Private VLAN	178
18.3.1	Having One Primary VLAN Type	178
18.3.2	Having Two Secondary VLAN Types	178
18.3.3	Port Types Under the Private VLAN Port.....	178
18.3.4	Modifying the Fields in VLAN TAG.....	179
18.4	Private VLAN Configuration Task List	179
18.5	Private VLAN Configuration Tasks.....	179
18.5.1	Configuring Private VLAN.....	179
18.5.2	Configuring the Association of Private VLAN Domains	179
18.5.3	Configuring the L2 Port of Private VLAN to Be the Host Port.....	180
18.5.4	Configuring the L2 Port of Private VLAN to Be the Promiscuous Port	180
18.5.5	Modifying Related Fields of Egress Packets in Private VLAN	181
18.5.6	Displaying the Configuration Information of Private VLAN	181
18.6	Configuration Example.....	181
Chapter 19.	STP Configuration	184
19.1	Configuring STP.....	184
19.1.1	STP Introduction	184
19.1.2	SSTP Configuration Task List.....	185
19.1.3	SSTP Configuration Task.....	185
19.1.4	Configuring VLAN STP	188
19.1.5	RSTP Configuration Task List.....	189
19.1.6	RSTP Configuration Task.....	190
19.2	Configuring MTSP.....	192
19.2.1	MSTP Overview	192
19.2.2	MSTP Configuration Task List.....	199
19.2.3	MSTP Configuration Task	201
Chapter 20.	STP Optional Characteristic Configuration	211
20.1	Configuring STP Optional Characteristic	211
20.1.1	STP Optional Characteristic Introduction.....	211
20.1.2	Configuring STP Optional Characteristic	217

Chapter 21.	Link Aggregation Configuration	222
21.1	Configuring Port Aggregation	222
21.1.1	Overview	222
21.1.2	Port Aggregation Configuration Task List.....	222
21.1.3	Port Aggregation Configuration Task	222
Chapter 22.	PDP Configuration	225
22.1	PDP Overview.....	225
22.1.1	Overview	225
22.1.2	PDP Configuration Tasks	225
22.1.3	PDP Configuration Example	226
Chapter 23.	LLDP Configuration	228
23.1	LLDP	228
23.1.1	LLDP Introduction	228
23.1.2	LLDP Configuration Task List.....	228
23.1.3	LLDP Configuration Task	228
Chapter 24.	FlexLinkLite Configuration	232
24.1	FlexLinkLite Configuration	232
24.1.1	FlexLinkLite Overview.....	232
24.1.2	FlexLinkLite Configuration	233
24.1.3	FlexLinkLite Configuration Example	234
Chapter 25.	BackupLink Configuration	236
25.1	BackupLink Overview	236
25.1.1	Overview	236
25.1.2	Port Aggregation Configuration Task	236
Chapter 26.	EAPS Configuration	239
26.1	Introduction of Fast Ethernet Ring Protection	239
26.1.1	Overview	239
26.1.2	Related Concepts of Fast Ether-Ring Protection	239
26.1.3	Types of EAPS Packets	241
26.1.4	Fast Ethernet Ring Protection Mechanism	242
26.2	Fast Ethernet Ring Protection Configuration	243
26.2.1	Default EAPS Settings	243
26.2.2	Requisites before Configuration	243
26.2.3	MEAPS Configuration Tasks.....	244
26.2.4	Fast Ethernet Ring Protection Configuration	244
26.2.5	MEAPS configuration.....	246
Chapter 27.	MEAPS Settings	248

27.1	MEAPS Introduction.....	248
27.1.1	MEAPS Overview	248
27.1.2	Basic Concepts of MEAPS	249
27.1.3	Types of EAPS Packets.....	253
27.1.4	Fast Ethernet Ring Protection Mechanism	253
27.2	Fast Ethernet Ring Protection Configuration	260
27.2.1	Requisites before Configuration	260
27.2.2	MEAPS Configuration Tasks.....	261
27.2.3	Fast Ethernet Ring Protection Configuration	261
27.3	Appendix.....	265
27.3.1	Working Procedure of MEAPS.....	265
27.3.2	Complete state.....	265
27.3.3	MEAPS configuration.....	269
27.3.4	Unfinished Configurations (to be continued).....	275
Chapter 28.	ELPS Configuration	277
28.1	ELPS Overview.....	277
28.1.1	Overview	277
Chapter 29.	UDLD Configuration	283
29.1	Unidirectional Link Detection (UDLD)	283
29.1.1	UDLD Overview	283
29.1.2	UDLD Configuration Task List.....	285
29.1.3	UDLD Configuration Tasks.....	285
29.1.4	Configuration Example	288
Chapter 30.	IGMP-Snooping Configuration	292
30.1	IGMP-snooping Configuration.....	292
30.1.1	IGMP-snooping Configuration Task	292
Chapter 31.	IGMP-Proxy Configuration	299
31.1	IGMP-proxy Configuration	299
Chapter 32.	MLD-Snooping Configuration	303
32.1	MLD-Snooping Configuration.....	303
32.1.1	IPv6 Multicast Overview	303
32.1.2	MLD-Snooping Multicast Configuration Tasks	303
Chapter 33.	OAM Configuration	309
33.1	OAM Configuration	309
33.1.1	OAM Overview.....	309
33.1.2	OAM Configuration Task List	312
33.1.3	OAM Configuration Tasks	312

33.1.4	Configuration Example	318
Chapter 34.	CFM and Y1731 Configuration	322
34.1	Overview	322
34.1.1	Stipulations	322
34.2	CFM Configuration	322
34.2.1	CFM Configuration Task List	322
34.2.2	CFM Maintenance Task List	322
34.2.3	CFM Configuration	323
34.2.4	CFM Maintenance	324
34.2.5	Configuration Example	324
34.3	Y1731 Configuration	325
34.3.1	Configuration Task List	325
Chapter 35.	DHCP-Snooping Configuration	327
35.1	DHCP-Snooping Configuration	327
35.1.1	DHCP-Snooping Configuration Tasks	327
Chapter 36.	MACFF Configuration	334
36.1	MACFF Settings	334
36.1.1	Configuration Tasks	334
Chapter 37.	IEEE 1588 Transparent Clock Configuration	338
37.1	Task List for IEEE1588 Transparent Clock Configuration	338
37.2	Tasks for IEEE1588 Transparent Clock Configuration	338
37.3	Enabling the Transparent Clock	338
37.3.1	Creating the Transparent Clock Port	339
37.3.2	Configuring the Link Delay Calculation Mode	339
37.3.3	Configuring the Forwarding Mode of Sync Packets	339
37.3.4	Configuring the Domain Filtration Function	340
37.3.5	Setting the Transmission Interval of Pdelay_Req Packets	340
37.4	PTP TC Configuration Example	341
Chapter 38.	Layer 2 Tunnel Protocol Configuration	342
38.1	Configuring Layer-2 Protocol Tunnel	342
38.1.1	Introduction	342
38.1.2	Configuring Layer-2 Protocol Tunnel	342
38.1.3	Configuration Example of Layer 2 Protocol Tunnel	342
Chapter 39.	Loopback Detection Configuration	344
39.1	Setting Loopback Detection	344
39.1.1	Introduction of Loopback Detection	344
39.1.2	Loopback Detection Configuration Tasks	345

39.1.3	Setting Loopback Detection	345
39.1.4	Configuration Example	348
Chapter 40.	QoS Configuration	350
40.1	QoS Configuration	350
40.1.1	QoS Overview.....	350
40.1.2	QoS Configuration Task List	353
40.1.3	QoS Configuration Tasks	353
40.1.4	QoS Configuration Example	361
Chapter 41.	DoS Attack Prevention Configuration	362
41.1	DoS Attack Prevention Configuration.....	362
41.1.1	DoS Attack Overview	362
41.1.2	DoS Attack Prevention Configuration Task List.....	363
41.1.3	DoS Attack Prevention Configuration Tasks	363
41.1.4	DoS Attack Prevention Configuration Example	364
Chapter 42.	Attack Prevention Configuration	365
42.1	Attack Prevention Configuration	365
42.1.1	Overview	365
42.1.2	Attack Prevention Configuration Tasks	365
42.1.3	Attack Prevention Configuration	365
42.1.4	Attack Prevention Configuration Example	366
Chapter 43.	Network Protocol Configuration	367
43.1	Configuring IP Addressing.....	367
43.1.1	IP Introduction.....	367
43.1.2	Configuring IP Address Task List	368
43.1.3	Configuring IP Address	369
43.2	Configuring NAT	375
43.2.1	Introduction	375
43.2.2	NAT Configuration Task List.....	376
43.2.3	NAT Configuration Task	377
43.2.4	NAT Configuration Example.....	385
43.3	Configuring DHCP	388
43.3.1	Introduction	388
43.3.2	Configuring DHCP Client	389
43.3.3	Configuring DHCP Server	390
43.4	IP Service Configuration	394
43.4.1	Configuring IP Service	394
43.4.2	Configuring Access List	399
43.4.3	Configuring IP Access List Based on Physical Port	402
Chapter 44.	IP ACL Application Configuration	406

44.1	Applying the IP Access Control List	406
44.1.1	Applying ACL on Ports	406
Chapter 45.	Routing Configuration	407
45.1	Configuring RIP	407
45.1.1	Overview	407
45.1.2	Configuring RIP Task List.....	407
45.1.3	Configuring RIP Tasks	408
45.1.4	RIP Configuration Example.....	412
45.2	Configuring BEIGRP	413
45.2.1	Overview	413
45.2.2	BEIGRP Configuration Task List.....	413
45.2.3	BEIGRP Configuration Task.....	414
45.2.4	BEIGRP Configuration Example	418
45.3	Configuring OSPF	418
45.3.1	Overview	418
45.3.2	OSPF Configuration Task List.....	419
45.3.3	OSPF Configuration Task	419
45.3.4	OSPF Configuration Example.....	425
45.4	Configuring BGP	431
45.4.1	Overview	431
45.4.2	BGP Configuration Task.....	432
45.4.3	Monitoring and Maintaining BGP	441
45.4.4	BGP Configuration Example	443
Chapter 46.	IP Hardware Subnet Routing Configuration	453
46.1	IP Hardware Subnet Configuration Task	453
46.1.1	Overview	453
46.1.2	Configuring IP Hardware Subnet Routing.....	453
46.1.3	Checking the State of IP Hardware Subnet Routing.....	454
46.2	Configuration Example.....	454
Chapter 47.	IP-PBR Configuration	456
47.1	IP-PBR Configuration	456
47.1.1	Enabling or Disabling IP-PBR Globally	456
47.1.2	ISIS Configuration Task List.....	457
47.1.3	Monitoring and Maintaining MVC.....	457
47.1.4	IP-PBR Configuration Example	459
Chapter 48.	Multi-VRF CE Configuration	461
48.1	Multi-VRF CE Introduction	461
48.1.1	Overview	461
48.2	Multi-VRF CE Configuration.....	462
48.2.1	Default VRF Configuration	462
48.2.2	MCE Configuration Tasks	462

48.2.3	MCE Configuration	462
48.3	MCE Configuration Example.....	465
48.3.1	Configuring S11	465
48.3.2	Configuring MCE-S1	466
48.3.3	Configuring PE.....	468
48.3.4	Configuring MCE-S2	470
48.3.5	Setting S22	472
48.3.6	TestifyingVRF Connectivity	472
Chapter 49.	Reliability Configuration	474
49.1	Configuring Port Backup	474
49.1.1	Overview	474
49.1.2	Backup InterfaceConfigratoin Task List	474
49.1.3	Backup InterfaceConfigratoin Task	474
49.1.4	Examples of Port Backup Configuration	475
49.2	Configuring HSRP protocol.....	476
49.2.1	Overview	476
49.2.2	HSRP protocol Configuration tast list.....	477
49.2.3	HSRP protocol Configuration tast	477
49.2.4	Example of Hot Standby Configuration	478
49.3	Configuring VRRP	479
49.3.1	VRRP Overview	479
49.3.2	VRRP Configuration Task List.....	481
49.3.3	VRRP Configuration Tasks	481
49.3.4	VRRP Configuration Example.....	483
Chapter 50.	Multicast Configuration	486
50.1	Multicast Overview	486
50.1.1	Multicast Routing Realization	486
50.1.2	Multicast Routing Configuration Task List.....	487
50.2	Basic Multicast Routing Configuration	488
50.2.1	Starting up Multicast Routing	488
50.2.2	Starting up the Multicast Function on the Port	488
50.2.3	Configuring TTL Threshold	489
50.2.4	Cancelling Rapid Multicast Forwarding	489
50.2.5	Configuring Static Multicast Route.....	489
50.2.6	Configuring IP Multicast Boundary.....	490
50.2.7	Configuring IP Multicast Rate Control	491
50.2.8	Configuring IP Multicast Helper	491
50.2.9	Configuring Stub Multicast Route	492
50.2.10	Monitoring and Maintaining Multicast Route	493
50.3	IGMP Configuration.....	494
50.3.1	Overview	494
50.3.2	IGMP Configuration	494
50.3.3	IGMP Characteristic Configuration Example	498
50.4	PIM-DM Configuration	500
50.4.1	PIM-DM Introduction	500
50.4.2	Configuring PIM-DM	501

50.4.3	PIM-DM State-Refresh Configuration Example	503
50.5	Configuring PIM-SM.....	503
50.5.1	PIM-SM Introduction	503
50.5.2	Configuring PIM-SM	505
50.5.3	Configuration Example	506
Chapter 51.	IPv6 Configuration	509
51.1	IPv6 Protocol's Configuration.....	509
51.2	Enabling IPv6.....	509
51.2.1	Setting the IPv6 Address	509
51.3	Setting the IPv6 Services.....	510
51.3.1	Setting the IPv6 Services.....	510
Chapter 52.	ND Configuration	513
52.1	ND Overview	513
52.1.1	Address Resolution.....	513
52.1.2	ND Configuration	514
Chapter 53.	RIPNG Configuration	517
53.1	Configuring RIPNG	517
53.1.1	Overview.....	517
53.1.2	Setting RIPng Configuration Task List	517
53.1.3	RIPng Configuration Tasks	518
53.1.4	RIPng Configuration Example	521
Chapter 54.	OSPFv3 Configuration	523
54.1	Overview	523
54.2	OSPFv3 Configuration Task List	524
54.3	OSPFv3 Configuration Tasks	524
54.3.1	Enabling OSPFv3	524
54.3.2	Setting the Parameters of the OSPFv3 Interface	525
54.3.3	Setting OSPFv3 on Different Physical Networks	525
54.3.4	Setting the OSPF Network Type	525
54.3.5	Setting the Parameters of the OSPFv3 Domain	526
54.3.6	Setting the Route Summary in the OSPFv3 Domain	526
54.3.7	Setting the Summary of the Forwarded Routes.....	527
54.3.8	Generating a Default Route	527
54.3.9	Choosing the Route ID on the Loopback Interface.....	527
54.3.10	Setting the Management Distance of OSPFv3	527
54.3.11	Setting the Timer of Routing Algorithm	528
54.3.12	Monitoring and Maintaining OSPFv3	528
54.4	OSPFv3 Configuration Example	529
54.4.1	Example for OSPFv3 Route Learning Settings	529
Chapter 55.	BFD Configuration	537

55.1	Overview	537
55.2	BFD Configuration Tasks	537
55.2.1	Activating Port BFD	537
55.2.2	Activating the Port BFD Query Mode.....	538
55.2.3	Activating Port BFD Echo	538
55.2.4	Enabling Port BFD Authentication	539
55.3	BFD Configuration Example	539
Chapter 56.	SNTP Configuration	541
56.1	Overview	541
56.1.1	Stipulations	541
56.2	SNTP Configuration	541
56.2.1	Overview	541
56.2.2	SNTP Configuration Task List.....	541
56.2.3	SNTP Configuration	542
Chapter 57.	Cluster Management Configuration	543
57.1	Overview	543
57.2	Cluster Management Configuration Task List	543
57.3	Cluster Management Configuration Task.....	543
57.3.1	Planning Cluster	543
57.3.2	Creating Cluster.....	544
57.3.3	Configuring Cluster	544
57.3.4	Monitoring the State of Standby Group	545
57.3.5	Using SNMP to Manage Cluster	545
57.3.6	Using Web to Manage Cluster	546

Chapter 1. INTRODUCTION

Thank you for purchasing PLANET L3 100G Managed Switch, XGS-6350-24X4C. The description of this model is as follows:

XGS-6350-24X4C	Layer 3 24-Port 10G SFP+ + 4-Port 100G QSFP28 Managed Switch
-----------------------	--

The term “**Managed Switch**” mentioned in this user’s manual refers to the **XGS-6350-24X4C**.

1.1 Packet Contents

Open the box of the Managed Switch and carefully unpack it. The box should contain the following items:

<input checked="" type="checkbox"/> The Managed Switch	x 1
<input checked="" type="checkbox"/> Quick Installation Guide	x 1
<input checked="" type="checkbox"/> Power Cord	x 1
<input checked="" type="checkbox"/> RJ45-to-DB9 Console Cable	x 1
<input checked="" type="checkbox"/> Rubber Feet	x 4
<input checked="" type="checkbox"/> Two Rack-mounting Brackets with Attachment Screws x 6	x 1
<input checked="" type="checkbox"/> SFP Dust Caps (installed on the machine)	x 28

If any of these are missing or damaged, please contact your dealer immediately; if possible, retain the carton including the original packing material, and use them again to repack the product in case there is a need to return it to us for repair.

Powerful 100Gbps Solution for All Long-Reach Networks

PLANET XGS-6350-24X4C is a high performance Layer 3 Managed Switch that meets the next generation Metro, Data Center, Campus and Enterprise network requirements. It has high-density **24 10G SFP+** and **4 40G/100GbE QSFP28** fiber interfaces delivered in a 1RU rugged case.

The XGS-6350-24X4C comes with the complete Layer 3 managed function with comprehensive protocols and applications to facilitate the rapid service deployment and management for both the traditional L2 and L3 networks. With support for advanced features, including **RIP, OSPF, BGP, PIM-DM/SM**, etc., this switch is ideal for the traditional or fully virtualized data center.

The administrator can flexibly choose the suitable transceivers according to the transmission distance or the transmission speed required extending the **1G/10G/40G/100G** network efficiently. Besides, with 800Gbps

switching capacity, the XGS-6350-24X4C can handle extremely large amounts of data in a secure topology linking to backbone or high capacity servers where audio, video streaming and multicast applications are utilized.

Extractive Power Supply Design to Increase Flexibility

The XGS-6350-24X4C is equipped with one extractive 100~240V AC power supply unit, so it is easy to replace the power for users. Besides, the XGS-6350-24X4C reserves another backup power slot on the rear panel and users can add the second AC or DC power to the redundant power supply installation. The AC power or DC power is optional. The redundant power system is specifically designed to handle the demands of high-tech facilities requiring the highest power integrity.

Layer 3 Routing Support

The XGS-6350-24X4C enables the administrator to conveniently boost network efficiency by configuring Layer 3 static routing manually, the **RIP (Routing Information Protocol)** or **OSPF (Open Shortest Path First)** settings automatically. The RIP can employ the hop count as a routing metric and prevent routing loops by implementing a limit on the number of hops allowed in a path from the source to a destination. The OSPF is an interior dynamic routing protocol for autonomous system based on link-state. The protocol creates a link-state database by exchanging link-states among Layer 3 switches, and then uses the Shortest Path First algorithm to generate a route table based on that database.

High Performance

The XGS-6350-24X4C boasts a high-performance switch architecture that is capable of providing non-blocking switch capacity and wire-speed throughput as high as **800Gbps**, which greatly simplifies the tasks of upgrading the LAN for catering to increasing bandwidth demands.

Abundant IPv6 Support

The XGS-6350-24X4C provides **IPv6 management** and enterprise-level secure features such as **SSH, ACL, WRR (Weighted Round Robin)** and **RADIUS** authentication. The XGS-6350-24X4C thus helps the enterprises to step in the IPv6 era with the lowest investment. In addition, you don't need to replace the network facilities when the IPv6 FTTx edge network is built.

Excellent and Secure Traffic Control

The XGS-6350-24X4C is loaded with powerful traffic management and WRR features to enhance services offered by telecoms and enterprises. The **WRR** functionalities include wire-speed Layer 4 traffic classifiers and bandwidth limitation which are particularly useful for multi-tenant unit, multi-business unit, Telco, or network service applications.

Powerful Security

The ACL policies supported can classify the traffic by source/destination IP addresses, source/destination MAC addresses, IP protocols, TCP/UDP, IP precedence, time ranges and ToS. Moreover, various policies can be conducted to forward the traffic. The XGS-6350-24X4C also provides IEEE 802.1x port based access authentication, which can be deployed with RADIUS, to ensure the port level security and block illegal users. Thus, the XGS-6350-24X4C empowers enterprises and campuses to take full advantage of the limited network resources and guarantees the best performance in VoIP and video conferencing transmission.

Robust Layer 2 Features

The XGS-6350-24X4C can be programmed for basic switch management functions such as port speed configuration, port aggregation, VLAN, Spanning Tree Protocol, WRR, bandwidth control and IGMP snooping. It also supports 802.1Q tagged VLAN, Q-in-Q, voice VLAN and GVRP Protocol. In addition, the number of VLAN interfaces is 1K and the number of VLAN IDs is 4K. By supporting port aggregation, the XGS-6350-24X4C allows the operation of a high-speed trunk combined with multiple ports. It enables up to 32 groups for trunking with a maximum of 8 ports for each group.

Efficient and Secure Management

For efficient management, the XGS-6350-24X4C Managed 100Gigabit Switch is equipped with console, Web and SNMP management interfaces. With its built-in Web-based management interface, the XGS-6350-24X4C offers an easy-to-use, platform-independent management and configuration facility. The XGS-6350-24X4C supports standard Simple Network Management Protocol (SNMP) and can be managed via any standard-based management software. For reducing product learning time, the XGS-6350-24X4C offers Cisco-like command via Telnet or console port. Moreover, the XGS-6350-24X4C offers secure remote management by supporting SSH connection which encrypts the packet content at each session.

Flexibility and Extension Solution

The XGS-6350-24X4C provides twenty four 10Gbps SFP+ and four 100Gbps QSFP28 Fiber interfaces. Each of the SFP+ slots supports **Dual Speed, 10GBASE-SR/LR or 100GBASE-SX/LX** and each of the QSFP28 slots supports native **100 Gigabit Ethernet, 40G and 4 x 10 Gigabit Ethernet modes**. Therefore, the administrator can flexibly choose the suitable SFP transceiver according to not only the transmission distance, but also the transmission speed required. The distance can be extended from 550 meters to 2km (multi-mode fiber) or up to 10/20/30/40/50/70/120 km (single-mode fiber or WDM fiber). They are well suited for applications within the enterprise data centers and distributions.

1.2 Product Features

➤ Physical Ports

- 24 10GBASE-SR/LR SFP+ slots, compatible with 1000BASE-SX/LX/BX SFP
- 4 QSFP28 slots with each supporting native 100 Gigabit Ethernet, 40G and 4 x 10 Gigabit Ethernet modes
- RJ45 to DB9 console interface for switch basic management and setup

➤ IP Routing Features

- Supports maximum 128 static routes and route summarization
- Supports dynamic routing protocol: RIP and OSPF

➤ Layer 2 Features

- Auto-MDI/MDI-X detection on each RJ45 port
- Prevents packet loss flow control
 - IEEE 802.3x pause frame flow control in full-duplex mode
 - Back-pressure flow control in half-duplex mode
- High performance Store-and-Forward architecture, broadcast storm control, port loopback detect
- 32K MAC address table, automatic source address learning and aging
- Supports VLAN
 - IEEE 802.1Q tag-based VLAN
 - GVRP for dynamic VLAN management
 - Up to 4094 active VLANs
 - Provider Bridging (VLAN Q-in-Q, IEEE 802.1ad) supported
 - Private VLAN Edge (PVE) supported
 - GVRP protocol for Management VLAN
 - Protocol-based VLAN
 - MAC-based VLAN
- Supports Link Aggregation
 - Maximum 32 trunk groups, up to 8 ports per trunk group
 - IEEE 802.3ad LACP (Link Aggregation Control Protocol)
 - Cisco ether-channel (static trunk)
- Supports Spanning Tree Protocol
 - IEEE 802.1D Classic Spanning Tree Protocol (STP)
 - IEEE 802.1w Rapid Spanning Tree Protocol (RSTP)
 - IEEE 802.1s Multiple Spanning Tree Protocol (MSTP), spanning tree by VLAN
 - BPDU & root guard
- Port mirroring to monitor the incoming or outgoing traffic on a particular port (many to many)

- Provides port mirror (many-to-1)

➤ **Quality of Service**

- 8 priority queues on all switch ports
- Supports strict priority and WRR (Weighted Round Robin) CoS policies
- Traffic classification
 - IEEE 802.1p CoS/ToS
 - IPv4/IPv6 DSCP
 - Port-based WRR
- Strict priority and WRR CoS policies

➤ **Multicast**

- Supports IPv4 IGMP snooping v1, v2 and v3, and IPv6 MLD v1 and v2 snooping
- Querier mode support
- Supports Multicast VLAN Register (MVR)

➤ **Security**

- IEEE 802.1x port-based network access authentication
- MAC-based network access authentication
- Built-in RADIUS client to co-operate with the RADIUS servers for IPv4 and IPv6
- TACACS+ login users access authentication
- IP-based Access Control List (ACL)
- MAC-based Access Control List
- Supports DHCP snooping
- Supports ARP inspection
- IP Source Guard prevents IP spoofing attacks
- Dynamic ARP Inspection discards ARP packets with invalid MAC address to IP address binding

➤ **Management**

- Management IP for IPv4 and IPv6
- Switch Management Interface
 - Console/Telnet Command Line Interface
 - Web switch management
 - SNMP v1, v2c, and v3 switch management
 - SSH secure access
- BOOTP and DHCP for IP address assignment
- Firmware upload/download via TFTP or HTTP Protocol for IPv4 and IPv6
- SNTP (Simple Network Time Protocol) for IPv4 and IPv6

- User privilege levels control
- Syslog server for IPv4 and IPv6
- Four RMON groups 1, 2, 3, 9 (history, statistics, alarms and events)
- Supports ping, trace route function for IPv4 and IPv6

1.3 Product Specifications

Product	XGS-6350-24X4C
Hardware Specifications	
QSFP28 Slots	4 with each supporting native 100/40 Gigabit Ethernet and 4 x 10 Gigabit Ethernet modes
SFP+ Slots	24 10GBASE-SR/LR SFP+ interfaces Compatible with 1000BASE-SX/LX/BX SFP transceiver
Console	1 x RJ45-to-DB9 serial port (9600, 8, N, 1)
Management	1 x RJ45 (10/100/1000BASE-T)
USB	1 x USB 2.0
Switch Architecture	Store-and-forward
Switch Capacity	800Gbps/non-blocking
Switch Throughput	960Mpps
Address Table	32K MAC address table with auto learning function
Shared Data Buffer	4MB
Flow Control	Back pressure for half duplex IEEE 802.3x pause frame for full duplex
Jumbo Frame	9KB
LED	System: PWR, SYS Ports: 40/100G QSFP Port: LNK/ACT
Dimensions (W x D x H)	442.5 x 364 x 44 mm, 1U height
Weight	5990g
Power Consumption	75 watts/210 BTU (maximum)
Power Requirements	AC 100~240V, 50/60Hz
Fan	4
Management Function	
System Configuration	Console; Telnet; SSH; Web browser; SNMP v1, v2c and v3
Management	Supports both IPv4 and IPv6 addressing Supports the user IP security inspection for IPv4/IPv6 SNMP Supports MIB and TRAP Supports IPv4/IPv6 TFTP Supports IPv4/IPv6 NTP

	<p>Supports RMON 1, 2, 3, 9 groups</p> <p>Supports the RADIUS authentication for IPv4/IPv6 Telnet user name and password</p> <p>Supports IPv4/IPv6 SSH</p> <p>The right configuration for users to adopt RADIUS server's shell management</p> <p>Supports CLI, console, Telnet</p> <p>Supports SNMPv1, v2c and v3</p> <p>Supports Security IP safety net management function: avoid unlawful landing at non-restrictive area</p> <p>Supports Syslog server for IPv4 and IPv6</p> <p>Supports TACACS+</p>
Layer 3 Function	
Routing Protocol	Static routing, RIP and OSPF
Routing Table	16K
DHCP	<p>DHCP client</p> <p>DHCP server, defaultroute</p> <p>DHCP relay</p>
VRRP	<p>Configure VRRP in interface VLAN;</p> <p>VRRP priority;</p> <p>VRRP standby;</p> <p>VRRP track</p>
Load Balancing	Use of equivalent routing, the correct load balancing function (by flow)
Layer 2 Function	
Port Configuration	<p>Port disable/enable</p> <p>Auto-negotiation 10/100/1000Mbps full and half duplex mode selection</p> <p>Flow control disable/enable</p> <p>Bandwidth control on each port</p> <p>Port loopback detect</p>
Port Status	Display each port's speed duplex mode, link status, flow control status and auto negotiation status
VLAN	<p>802.1Q tag-based VLAN, up to 4K VLAN entries</p> <p>802.1ad Q-in-Q (VLAN stacking)</p> <p>GVRP for VLAN management</p> <p>Private VLAN Edge (PVE) supported</p> <p>Protocol-based VLAN</p> <p>MAC-based VLAN</p> <p>IP subnet VLAN</p>
Bandwidth Control	TX/RX/both

Link Aggregation	<p>IEEE 802.3ad LACP/static trunk</p> <p>Supports 32 groups with 8 ports per trunk group</p>
QoS	<p>8 priority queues on all switch ports</p> <p>Supports strict priority and Weighted Round Robin (WRR) CoS policies</p> <p>Traffic classification:</p> <ul style="list-style-type: none"> - IEEE 802.1p CoS/ToS - IPv4/IPv6 DSCP - Port-based WRR
Multicast	<p>IGMP v1/v2/v3 snooping</p> <p>Querier mode support</p> <p>MLD v1/v2 snooping</p> <p>Querier mode support</p> <p>Multicast VLAN Register (MVR)</p>
Access Control List	<p>Supports Standard and Expanded ACL</p> <p>IP-based ACL/MAC-based ACL</p> <p>Time-based ACL</p> <p>Up to 1K entries</p>
Bandwidth Control	<p>At least 64Kbps stream</p>
Security	<p>Port isolation</p> <p>Supports IP + MAC + port binding</p> <p>Identification and filtering of L2/L3/L4 based ACL</p> <p>Defends against DOS or TCP attacks</p> <p>Suppression of broadcast, multicast and unknown unicast packet</p> <p>DHCP snooping, DHCP option 82</p> <p>Command line authority control based on user levels</p>
Authentication	<p>IEEE 802.1x port-based network access control</p> <p>AAA authentication: TACACS+ and IPv4/IPv6 over RADIUS</p>
SNMP MIBs	<p>RFC 1213 MIB-II</p> <p>RFC 1215 Internet Engineering Task Force</p> <p>RFC 1271 RMON</p> <p>RFC 1354 IP-Forwarding MIB</p> <p>RFC 1493 Bridge MIB</p> <p>RFC 1643 Ether-like MIB</p> <p>RFC 1907 SNMPv2</p> <p>RFC 2011 IP/ICMP MIB</p> <p>RFC 2012 TCP MIB</p> <p>RFC 2013 UDP MIB</p> <p>RFC 2096 IP forward MIB</p>

	<p>RFC 2233 if MIB</p> <p>RFC 2452 TCP6 MIB</p> <p>RFC 2454 UDP6 MIB</p> <p>RFC 2465 IPv6 MIB</p> <p>RFC 2466 ICMP6 MIB</p> <p>RFC 2573 SNMPv3 notification</p> <p>RFC 2574 SNMPv3 VACM</p> <p>RFC 2674 Bridge MIB Extensions</p>
Standard Conformance	
Regulatory Compliance	FCC Part 15 Class A, CE
Standards Compliance	<p>IEEE 802.3z Gigabit 1000BASE-SX/LX</p> <p>IEEE 802.3ae 10Gb/s Ethernet</p> <p>IEEE 802.3x flow control and back pressure</p> <p>IEEE 802.3ad port trunk with LACP</p> <p>IEEE 802.1D Spanning Tree Protocol</p> <p>IEEE 802.1w Rapid Spanning Tree Protocol</p> <p>IEEE 802.1s Multiple Spanning Tree Protocol</p> <p>IEEE 802.1p Class of Service</p> <p>IEEE 802.1Q VLAN tagging</p> <p>IEEE 802.1X port authentication network control</p> <p>IEEE 802.1ab LLDP</p> <p>RFC 768 UDP</p> <p>RFC 793 TFTP</p> <p>RFC 791 IP</p> <p>RFC 792 ICMP</p> <p>RFC 2068 HTTP</p> <p>RFC 1112 IGMP v1</p> <p>RFC 2236 IGMP v2</p> <p>RFC 3376 IGMP v3</p> <p>RFC 2710 MLD v1</p> <p>RFC 3810 MLD v2</p> <p>RFC 2328 OSPF v2</p> <p>RFC 1058 RIP v1</p> <p>RFC 2453 RIP v2</p>
Environment	
Operating	<p>Temperature: 0 ~ 50 degrees C (24 x 10G SFP+ + 2 x QSFP28)</p> <p>Relative Humidity: 10 ~ 85% (non-condensing)</p>
Storage	Temperature: -40 ~ 80 degrees C

	Relative Humidity: 5 ~ 95% (non-condensing)
--	---

Chapter 2. INSTALLATION

This section describes how to install your **Managed Switch** and make connections to the **Managed Switch**. Please read the following topics and perform the procedures in the order being presented. To install your **Managed Switch** on a desktop or shelf, simply complete the following steps.

In this paragraph, we will describe how to install the **Managed Switch** and the installation points attended to it.

2.1 Hardware Description

2.1.1 Switch Front Panel

The unit front panel provides a simple interface monitoring the switch. Figure 2-1 shows the front panels of the Managed Switches.

XGS-6350-24X4C Front Panel

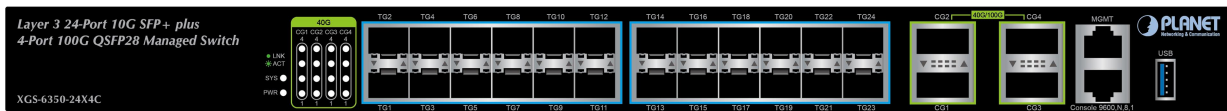

Figure 2-1 XGS-6350-24X4C front panel

■ 100 Gigabit SFP Slot

100GBASE-SR4/LR4 QSFP28 slot, SFP (Small Factor Pluggable) Transceiver Module supports from 100 meters (multi-mode fiber), to up to 10 kilometers (single mode fiber)

■ 10 Gigabit SFP Slot

10GBASE-SR/LR mini-GBIC slot, SFP (Small Factor Pluggable) Transceiver Module supports from 300 meters (multi-mode fiber), to up to 10 kilometers (single mode fiber)

■ Console Port

The console port is an RJ45 port connector. It is an interface for connecting a terminal directly. Through the console port, it provides rich diagnostic information including IP address setting, factory reset, port management, link status and system setting. Users can use the attached DB9 to RJ45 console cable in the package and connect to the console port on the device. After the connection, users can run any terminal emulation program (Hyper Terminal, ProComm Plus, Telix, Winterm and so on) to enter the startup screen of the device.

■ Management Port

The management port is designed for accessing to the Web UI of Managed Switch for configuration.

2.1.2 LED Indications

The front panel LEDs indicates instant status of port links, data activity, system operation, stack status and system power.

XGS-6350-24X4C LED Indication

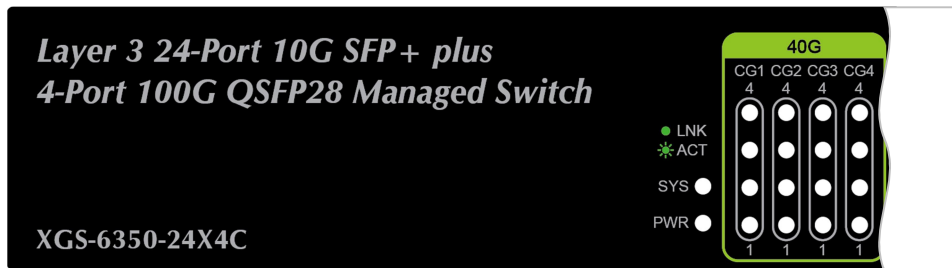

Figure 2-2 XGS-6350-24X4C LED Panel

System

LED	Color	Function
PWR	Green	Lights to indicate that the Switch has power.
	Off	Power is off.
SYS	Green	Blinks to indicate the system diagnosis is completed; lights to indicate the system is normally starting up.

SFP+ Interfaces

LED	Color	Function
LNK/ACT	Green	Blinks to indicate the data is transmitting and receiving through the port; lights to indicate the link on the port is normal.

40G Status LED (Divided into 4 10G)

LED	Color	Function
LNK/ACT (CG1~CG4)	Green	Operating in 100G mode, the LED does not light; when the QSFP+ corresponding port indicator is lit, 4 indicators indicate the LINK/ACT status of the 4 10GE ports corresponding to the QSFP+ port.

2.1.3 Switch Rear Panel

The rear panel of the Managed Switch indicates AC inlet power sockets, which accept input power from 100

to 240V AC, 50-60Hz. Figure 2-3 shows the rear panel of this Managed Switch.

XGS-6350-24X4C Rear Panel



Figure 2-3 Rear Panel of XGS-6350-24X4C

■ AC Power Receptacle

For compatibility with electric service in most areas of the world, the Managed Switch's power supply automatically adjusts to line power in the range of 100-240VAC and 50/60 Hz.

Plug the female end of the power cord firmly into the receptacle on the rear panel of the Managed Switch. Plug the other end of the power cord into an electric service outlet and then the power will be ready.

2.2 Installing the Managed Switch

This section describes how to install your **Managed Switch** and make connections to the **Managed Switch**. Please read the following topics and perform the procedures in the order being presented. To install your **Managed Switch** on a desktop or shelf, simply complete the following steps.

In this paragraph, we will describe how to install the **Managed Switch** and the installation points attended to it.

2.2.1 Desktop Installation

To install the Managed Switch on desktop or shelf, please follow these steps:

Step 1: Attach the rubber feet to the recessed areas on the bottom of the Managed Switch.

Step 2: Place the Managed Switch on the desktop or the shelf near an AC power source.

Step 3: Keep enough ventilation space between the Managed Switch and the surrounding objects.

Step 4: Connect the Managed Switch to network devices.

Connect one end of a standard fiber cable to the 10G SFP+ and 100G QSFP28 SFP slots on the front of the Managed Switch. Connect the other end of the fiber cable to the network devices such as switches, storages, routers or others.

Step 5: Supply power to the Managed Switch.

Connect one end of the power cable to the Managed Switch. Connect the power plug of the power cable into a standard wall outlet. When the Managed Switch receives power, the Power LED should remain solid Green.

2.2.2 Rack Mounting

To install the Managed Switch in a 19-inch standard rack, please follow the instructions described below.

Step 1: Place the Managed Switch on a hard flat surface, with the front panel positioned towards the front side.

Step 2: Attach the rack-mount bracket to each side of the Managed Switch with supplied screws attached to the package.



You must use the screws supplied with the mounting brackets. Damage caused to the parts by using incorrect screws would invalidate the warranty.

Step 3: Secure the brackets tightly.

Step 4: Follow the same steps to attach the second bracket to the opposite side.

Step 5: After the brackets are attached to the Managed Switch, use suitable screws to securely attach the brackets to the rack.

Step 6: Proceeds with Steps 4 and 5 of session 2.2.1 Desktop Installation to connect the network cabling and supply power to the Managed Switch.

2.2.3 Installing the SFP/SFP+/QSFP28 100G SFP Transceiver

The sections describe how to insert an SFP/SFP+/QSFP28 100G SFP transceiver into an SFP/SFP+/QSFP28 100G SFP slot. The SFP/SFP+/QSFP28 100G SFP transceivers are hot-pluggable and hot-swappable. You can plug in and out the transceiver to/from any SFP/SFP+/QSFP28 100G SFP port without having to power down the Managed Switch, as Figure 2-4 shows.

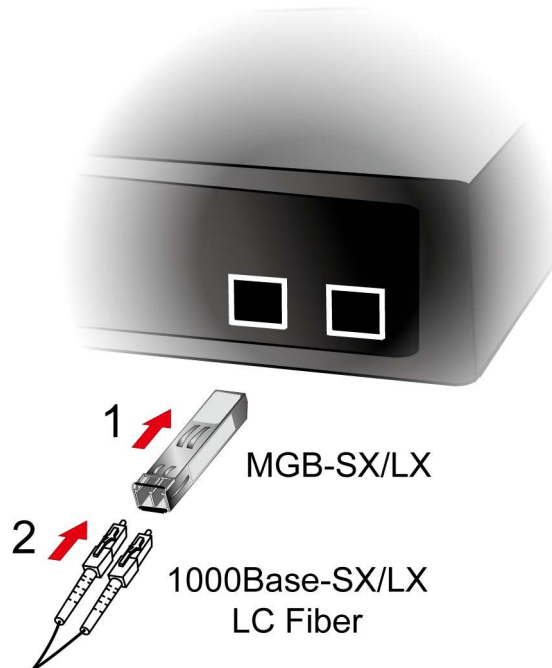

Figure 2-4 Plug in the SFP transceiver

■ **Approved PLANET SFP/SFP+/QSFP28 100G SFP Transceivers**

PLANET Managed Switch supports both single mode and multi-mode SFP/SFP+/QSFP28 100G SFP

transceivers. The following list of approved PLANET SFP/SFP+/QSFP28 100G SFP transceiver is correct at the time of publication:

Gigabit Ethernet Transceiver (1000BASE-XSFP)

Model	Speed (Mbps)	Connector Interface	Fiber Mode	Distance	Wavelength (nm)	Operating Temp.
MGB-GT	1000	Copper	--	100m	--	0 ~ 60 degrees C
MGB-SX	1000	LC	Multi Mode	550m	850nm	0 ~ 60 degrees C
MGB-SX2	1000	LC	Multi Mode	2km	1310nm	0 ~ 60 degrees C
MGB-LX	1000	LC	Single Mode	10km	1310nm	0 ~ 60 degrees C
MGB-L30	1000	LC	Single Mode	30km	1310nm	0 ~ 60 degrees C
MGB-L50	1000	LC	Single Mode	50km	1550nm	0 ~ 60 degrees C
MGB-L70	1000	LC	Single Mode	70km	1550nm	0 ~ 60 degrees C
MGB-L120	1000	LC	Single Mode	120km	1550nm	0 ~ 60 degrees C
MGB-TSX	1000	LC	Multi Mode	550m	850nm	-40 ~ 75 degrees C
MGB-TLX	1000	LC	Single Mode	10km	1310nm	-40 ~ 75 degrees C
MGB-TL30	1000	LC	Single Mode	30km	1310nm	-40 ~ 75 degrees C
MGB-TL70	1000	LC	Single Mode	70km	1550nm	-40 ~ 75 degrees C

Gigabit Ethernet Transceiver (1000BASE-BX, Single Fiber Bi-directional SFP)

Model	Speed (Mbps)	Connector Interface	Fiber Mode	Distance	Wavelength (TX/RX)	Operating Temp.
MGB-LA10	1000	WDM(LC)	Single Mode	10km	1310nm/1550nm	0 ~ 60 degrees C
MGB-LB10	1000	WDM(LC)	Single Mode	10km	1550nm/1310nm	0 ~ 60 degrees C
MGB-LA20	1000	WDM(LC)	Single Mode	20km	1310nm/1550nm	0 ~ 60 degrees C
MGB-LB20	1000	WDM(LC)	Single Mode	20km	1550nm/1310nm	0 ~ 60 degrees C
MGB-LA40	1000	WDM(LC)	Single Mode	40km	1310nm/1550nm	0 ~ 60 degrees C
MGB-LB40	1000	WDM(LC)	Single Mode	40km	1550nm/1310nm	0 ~ 60 degrees C
MGB-LA60	1000	WDM(LC)	Single Mode	60km	1310nm/1550nm	0 ~ 60 degrees C
MGB-LB60	1000	WDM(LC)	Single Mode	60km	1550nm/1310nm	0 ~ 60 degrees C
MGB-TLA10	1000	WDM(LC)	Single Mode	10km	1310nm/1550nm	-40 ~ 75 degrees C
MGB-TLB10	1000	WDM(LC)	Single Mode	10km	1550nm/1310nm	-40 ~ 75 degrees C
MGB-TLA20	1000	WDM(LC)	Single Mode	20km	1310nm/1550nm	-40 ~ 75 degrees C
MGB-TLB20	1000	WDM(LC)	Single Mode	20km	1550nm/1310nm	-40 ~ 75 degrees C
MGB-TLA40	1000	WDM(LC)	Single Mode	40km	1310nm/1550nm	-40 ~ 75 degrees C
MGB-TLB40	1000	WDM(LC)	Single Mode	40km	1550nm/1310nm	-40 ~ 75 degrees C
MGB-TLA60	1000	WDM(LC)	Single Mode	60km	1310nm/1550nm	-40 ~ 75 degrees C
MGB-TLB60	1000	WDM(LC)	Single Mode	60km	1550nm/1310nm	-40 ~ 75 degrees C

10Gbps SFP+ (10G Ethernet/10GBASE)

Model	Speed (Mbps)	Connector Interface	Fiber Mode	Distance	Wavelength (nm)	Operating Temp.
MTB-SR	10G	LC	Multi Mode	Up to 300m	850nm	0 ~ 60 degrees C
MTB-LR	10G	LC	Single Mode	10km	1310nm	0 ~ 60 degrees C

10Gbps SFP+ (10GBASE-BX, Single Fiber Bi-directional SFP)

Model	Speed (Mbps)	Connector Interface	Fiber Mode	Distance	Wavelength (TX)	Wavelength (RX)	Operating Temp.
MTB-LA20	10G	WDM(LC)	Single Mode	20km	1270nm	1330nm	0 ~ 60 degrees C
MTB-LB20	10G	WDM(LC)	Single Mode	20km	1330nm	1270nm	0 ~ 60 degrees C
MTB-LA40	10G	WDM(LC)	Single Mode	40km	1270nm	1330nm	0 ~ 60 degrees C
MTB-LB40	10G	WDM(LC)	Single Mode	40km	1330nm	1270nm	0 ~ 60 degrees C
MTB-LA60	10G	WDM(LC)	Single Mode	60km	1270nm	1330nm	0 ~ 60 degrees C
MTB-LB60	10G	WDM(LC)	Single Mode	60km	1330nm	1270nm	0 ~ 60 degrees C

100Gbps QSFP28 SFP (100G Ethernet/100GBASE)

Model	Speed (Mbps)	Connector Interface	Fiber Mode	Distance	Wavelength (nm)	Operating Temp.
QSFP-100G-SR4	100G	MPO	Multi Mode	Up to 100m	850nm	0 ~ 70 degrees C
QSFP-100G-LR4	100G	LC	Single Mode	10km	1310nm	0 ~ 70 degrees C



It is recommended to use PLANET SFP/SFP+/QSFP28 100G SFP on the Managed Switch. If you insert an SFP/SFP+/QSFP28 100G SFP transceiver that is not supported, the Managed Switch will not recognize it.

1. Before we connect the XGS-6350-24X4C to the other network device, we have to make sure both sides of the SFP transceivers are with the same media type, for example: 1000BASE-SX to 1000BASE-SX, 1000BASE-LX to 1000BASE-LX.
2. Check whether the fiber-optic cable type matches with the SFP transceiver requirement.
 - To connect to 1000BASE-SX SFP transceiver, please use the multi-mode fiber cable with one side being the male duplex LC connector type.
 - To connect to 1000BASE-LX SFP transceiver, please use the single-mode fiber cable with one side being the male duplex LC connector type.

■ **Connect the Fiber Cable**

1. Insert the duplex LC connector into the SFP/SFP+ transceiver.
2. Connect the other end of the cable to a device with SFP/SFP+ transceiver installed.
3. Check the LNK/ACT LED of the SFP/SFP+ slot on the front of the Managed Switch. Ensure that the

SFP/SFP+ transceiver is operating correctly.

4. Check the Link mode of the SFP/SFP+ port if the link fails. To function with some fiber-NICs or media converters, user has to set the port Link mode to “**10GForce**” or “**1000M Force**”.

■ **Remove the Transceiver Module**

1. Make sure there is no network activity anymore.
2. Remove the Fiber-optic Cable gently.
3. Lift up the lever of the MGB module and turn it to a horizontal position.
4. Pull out the module gently through the lever.



Figure 2-5: How to Pull Out the SFP/SFP+Transceiver



Note

Never pull out the module without lifting up the lever of the module and turning it to a horizontal position. Directly pulling out the module could damage the module and the SFP/SFP+ module slot of the Managed Switch.

Chapter 3. Switch Management

3.1 Management Options

After purchasing the switch, the user needs to configure the switch for network management. Switch provides two management options: in-band management and out-of-band management.

3.1.1 Out-Of-Band Management

Out-of-band management is the management through Console interface. Generally, the user will use out-of-band management for the initial switch configuration, or when in-band management is not available. For instance, the XGS-6350-24X4C default IP address is 192.168.0.254 or the user can try to assign a new IP address to the switch via the console interface to be able to access the switch through Telnet.

The procedures for managing the switch via Console interface are listed below:

Step 1: Setting up the environment:

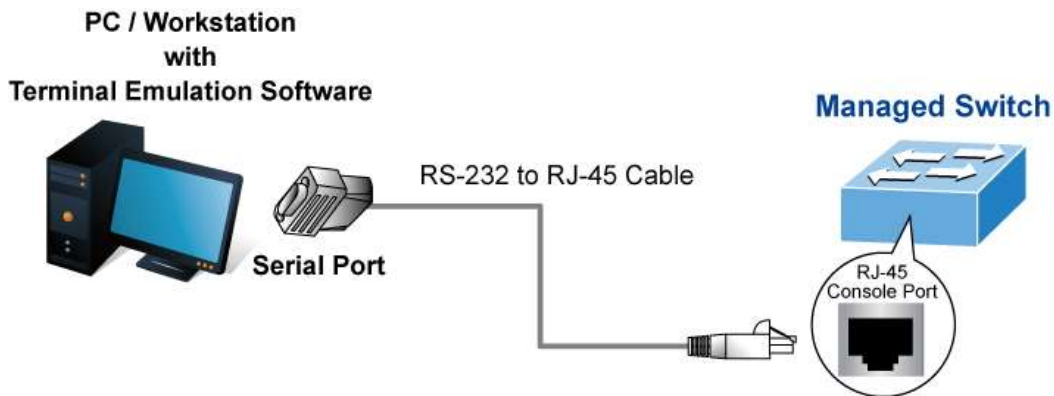

Figure 3-1 Out-of-Band Management Configuration Environment

As shown in the above, the serial port (RS232) is connected to the switch with the serial cable provided. The table below lists all the devices used in the connection.

Device Name	Description
PC machine	Has functional keyboard and RS232, with terminal emulator installed, such as Tera Term and hyper terminal.
Serial port cable	One end is connected to the RS232 serial port; the other end to the console port.
Switch	Functional console port required.

Step 2: Entering the HyperTerminal

Open the HyperTerminal included in Windows after the connection is established. The example below is based on the HyperTerminal included in Windows XP.

- 1) Click Start menu -- All Programs -- Accessories -- Communication -- **HyperTerminal**.

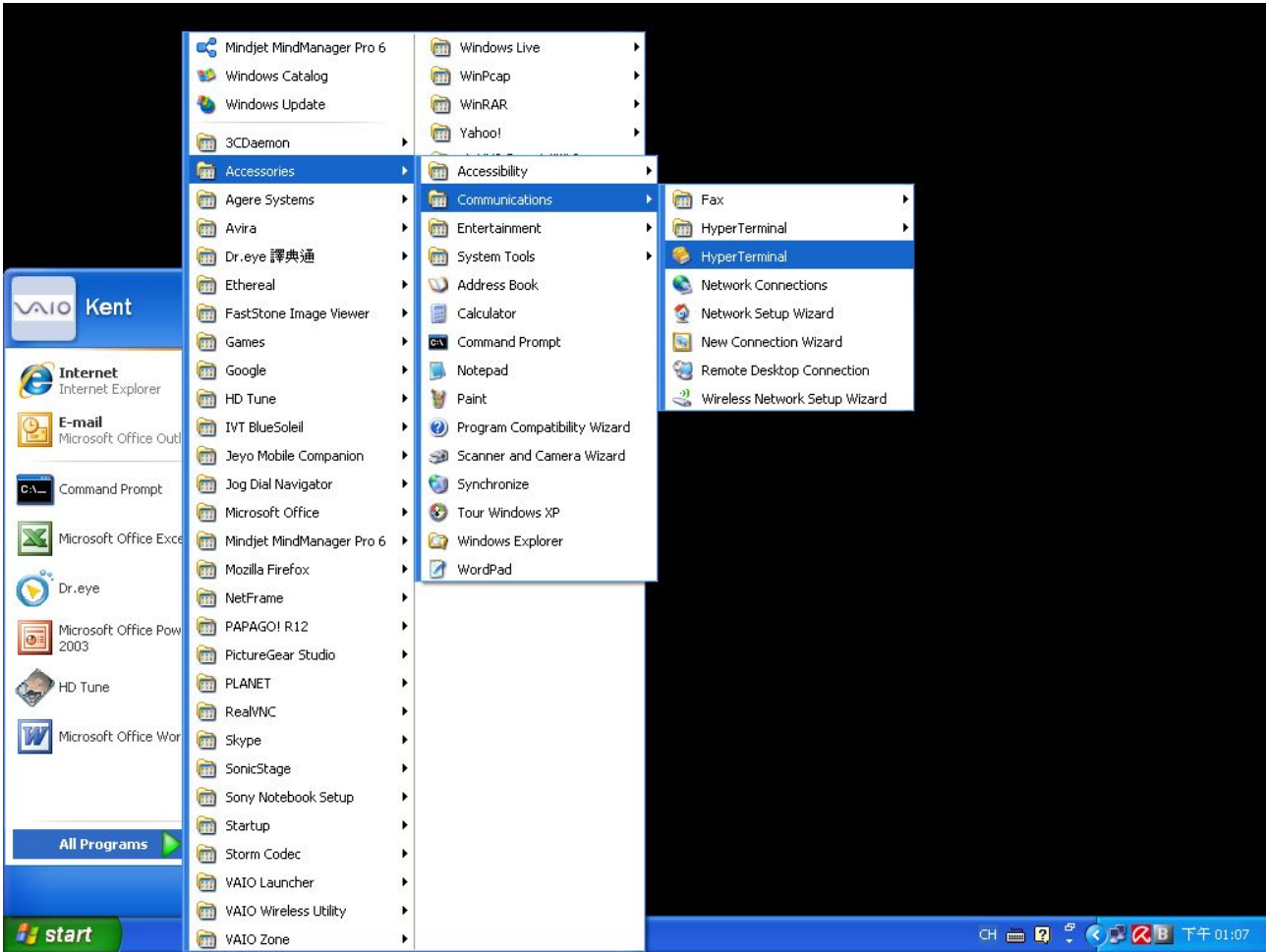

Figure 3-2 Opening Hyper Terminal

- 2) Type a name for opening HyperTerminal, such as "Switch".

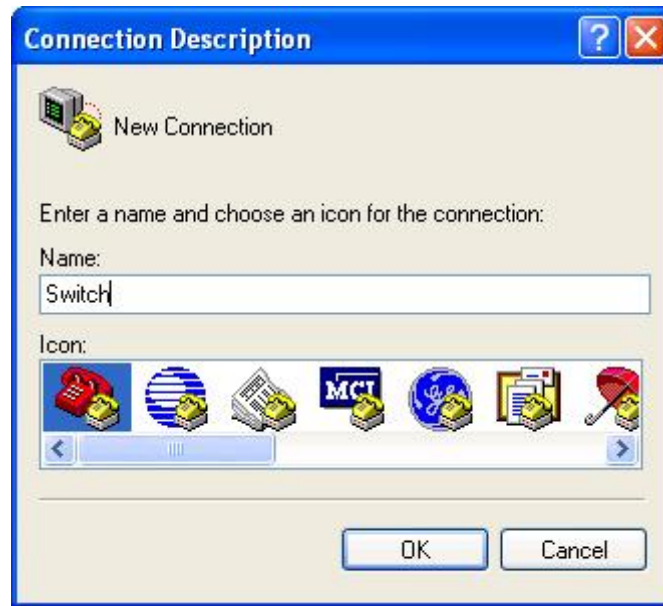

Figure 3-3 Opening HyperTerminal

3) In the “Connect using” drop-list, select the RS-232 serial port used by the PC, e.g., COM1, and click “OK”.



Figure3-4 Opening HyperTerminal

4) COM1 property appears and select “9600” for “Baud rate”, “8” for “Data bits”, “none” for “Parity checksum”, “1” for stop bit and “none” for traffic control; or you can also click “Restore default” and click “OK”.

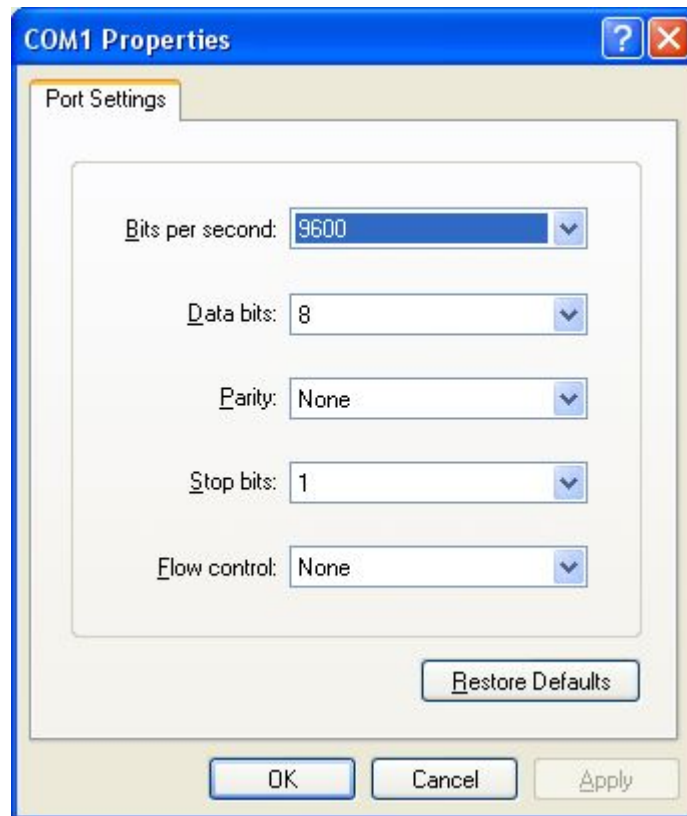

Figure3-5 Opening HyperTerminal

Step 3: Entering switch CLI interface

Power on the switch and the following appears in the HyperTerminal windows, that is the CLI configuration mode for Switch.

```
Jan 18 21: 48: 00 User admin logout on console 0
```

```
System Bootstrap, Version 0.1.1, Serial No: A98005YM01012076
```

```
Copyright (c) 2018 PLANET Technology Corporation
```

```
PLANET XGS-6350-24X4C
```

```
Current time: 1970-1-1 0: 00: 00
```

```
SDRAM Fast Test.....PASS!
```

```
Flash Fast Test.....PASS!
```

```
RTC Test.....PASS!
```

```
Loading flash:/switch.bin.....
```

```
Start Decompressing flash:/switch.bin
```

```
#####
```

```
Switch console 0 is now available
```

```
Press RETURN to get started
```

```
Jan 1 00: 00: 42 User default logout on console 0
```

```
Jan  1 00:00:52 %MEM-6-EXT_REGION_CREATE 14c99c4: Create extend region for region
1 rank 0, 1417805 blocks 56712246 bytes
User Access Verification
```

```
Username: admin
```

```
Password:
```

```
Welcome to PLANET XGS-6350-24X4C Ethernet Switch
```

```
Switch>
```

The user can now enter commands to manage the switch. For a detailed description of the commands, please refer to the following chapters.

3.1.2 In-band Management

In-band management refers to the management by logging in to the switch using Telnet, or using HTTP, or using SNMP management software to configure the switch. In-band management enables management of the switch for some devices attached to the switch. In the case when in-band management fails due to switch configuration changes, out-of-band management can be used for configuring and managing the switch.

3.1.2.1 Management via Telnet

To manage the switch with Telnet, the following conditions should be met:

- 1) Switch has an IPv4/IPv6 address configured;
- 2) The host IP address (Telnet client) and the switch's VLAN interface IPv4/IPv6 address is in the same network segment;
- 3) If 2) is not met, Telnet client can connect to an IPv4/IPv6 address of the switch via other devices, such as a router.

The switch is a Layer 3 switch that can be configured with several IPv4/IPv6 addresses. The following example assumes the shipment status of the switch where only VLAN1 exists in the system. The following describes the steps for a Telnet client to connect to the switch's VLAN1 interface by Telnet (with IPv4 address as an example):

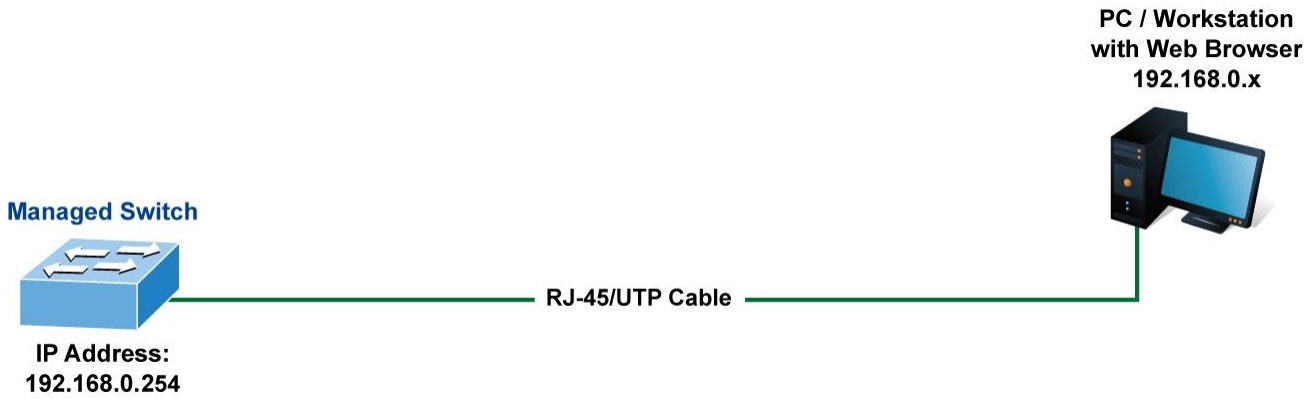

Figure3-6 Manage the Switch by Telnet

Step 1: Configure the IP addresses for the switch and start the Telnet Server function on the switch. First is the configuration of host IP address. This should be within the same network segment as the switch VLAN1 interface IP address. Suppose the switch VLAN1 interface IP address is 10.1.128.251/24. Then, a possible host IP address is 10.1.128.252/24. Run “ping 10.1.128.251” from the host and verify the result. Check for reasons if ping fails.

The IP address configuration commands for VLAN1 interface are listed below. Before in-band management is used, the switch must be configured with an IP address by out-of-band management (i.e. Console mode). The configuration commands are as follows (All switch configuration prompts are assumed to be “Switch” hereafter if not otherwise specified.):

```
Switch#  
Switch#config  
Switch_config#interface vlan 1  
Switch_config_v1#ip address 10.1.128.251 255.255.255.0  
Switch_config_v1#exit  
Switch_config#write
```

Step 2: Run Telnet Client program.

Run Telnet client program included in Windows with the specified Telnet target.

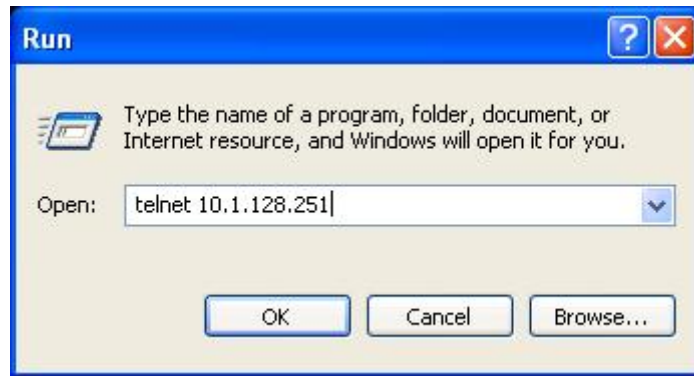

Figure3-7 Run telnet client program included in Windows

Step 3: Log in to the switch.

Log in to the Telnet configuration interface. Valid login name and password are required, otherwise, the switch will reject Telnet access. This is the method to protect the switch from unauthorized access.

Enter valid login name and password in the Telnet configuration interface, Telnet user will be able to enter the switch's CLI configuration interface. The commands used in the Telnet CLI interface after login is the same as that in the console interface.

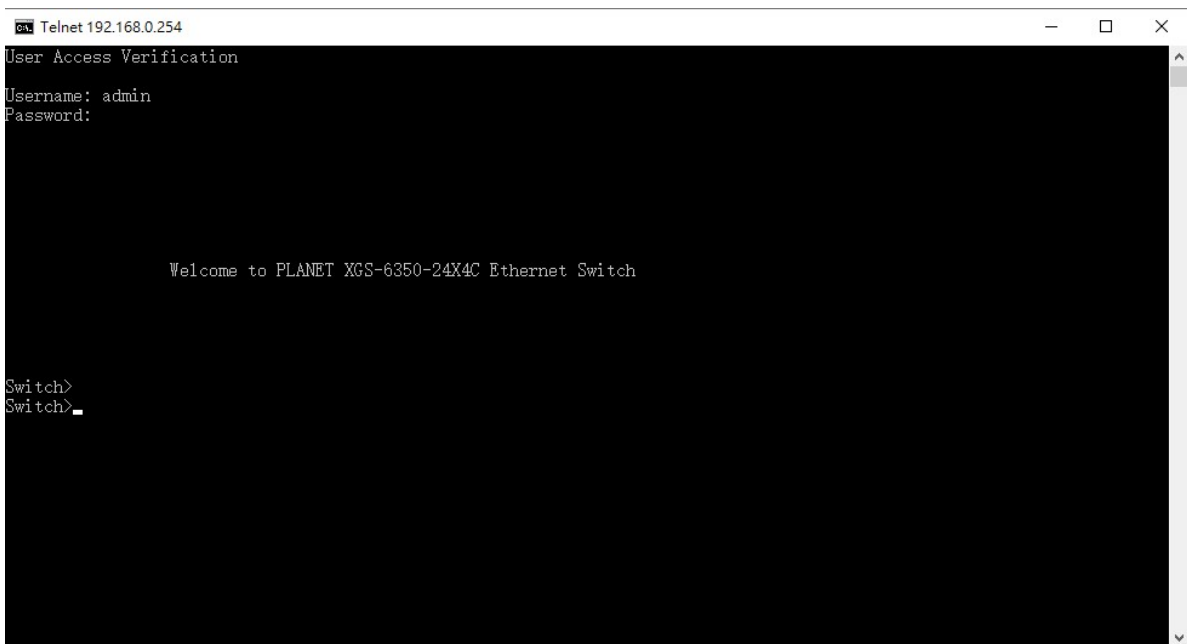

Figure3-8 Telnet Configuration Interface

3.1.2.2 Management via HTTP

To manage the switch via HTTP, the following conditions should be met:

- 1) Switch has an IPv4/IPv6 address configured;
- 2) The host IPv4/IPv6 address (HTTP client) and the switch's VLAN interface IPv4/IPv6 address are in the same network segment;

- 3) If 2) is not met, HTTP client should connect to an IPv4/IPv6 address of the switch via other devices, such as a router.

Similar to management the switch via Telnet, as soon as the host succeeds to ping/ping6 an IPv4/IPv6 address of the switch and to type the right login password, it can access the switch via HTTP. The configuration list is shown below:

Step 1: Configure the IP addresses for the switch and start the HTTP server function on the switch. For configuring the IP address on the switch through out-of-band management, see the Telnet management chapter.

To enable the Web configuration, users should type the CLI command IP http server in the global mode as shown below:

```
Switch#  
Switch#config  
Switch_config#ip http server
```



The HTTP server of XGS-6350-24X4C is enabled by default.

Step 2: Run HTTP protocol on the host.

Open the Web browser on the host and type the IP address of the switch, or run directly the HTTP protocol on the Windows. For example, the IP address of the switch is “10.1.128.251”;

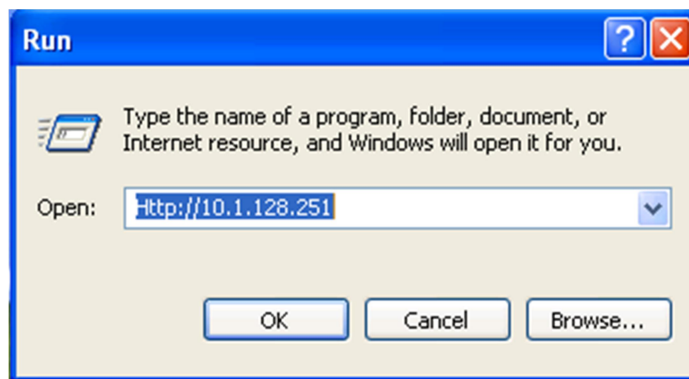

Figure3-9 Run HTTP Protocol

When accessing a switch with IPv6 address, it is recommended to use the Firefox browser with 1.5 or later version. For example, if the IPv6 address of the switch is 3ffe: 506: 1: 2:: 3, the IPv6 address of the switch should be **http: //[3ffe: 506:1:2:: 3]**. Please note the address should be in the square brackets.

Step 3: Log in to the switch.

Logging to the Web configuration interface. Valid login name and password are required, otherwise, the switch will reject HTTP access. This is the method to protect the switch from unauthorized access.

The Web login interface of XGS-6350-24X4C is shown below:



Figure3-10 Web Login Interface

Input the right username and password and then the main Web configuration interface is shown below.

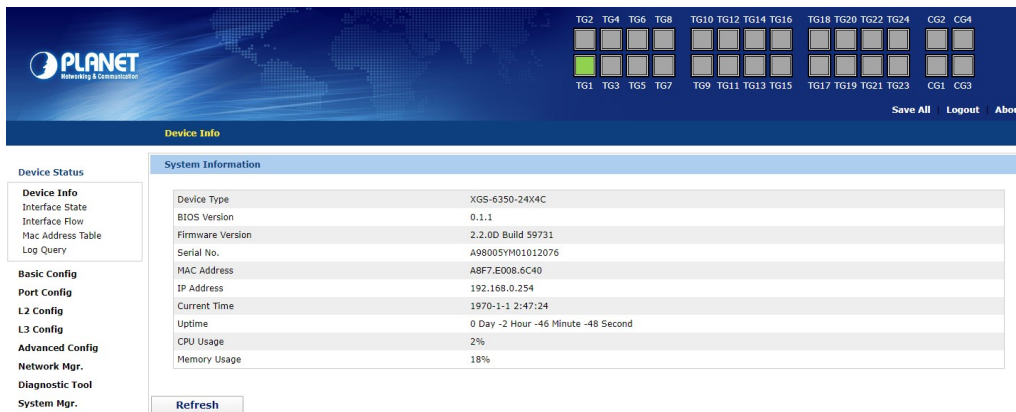

Figure3-11 Main Web Configuration Interface



When configuring the switch, the name of the switch is composed of English letters.

3.1.2.3 Manage the Switch via SNMP Network Management Software

The followings are required by SNMP network management software to manage switches:

- 1) IP addresses are configured on the switch;
- 2) The IP address of the client host and that of the VLAN interface on the switch it subordinates to

- should be in the same segment;
- 3) If 2) is not met, the client should be able to reach an IP address of the switch through devices like routers;
- 4) SNMP should be enabled.

The host with SNMP network management software should be able to ping the IP address of the switch, so that when running, SNMP network management software will be able to find it and implement read/write operation on it. Details about how to manage switches via SNMP network management software will not be covered in this manual; please refer to “Simple Network Management software user manual”.

CLI Interface

The switch provides three management interfaces for users: CLI (Command Line Interface) interface, Web interface and Simple Network Management software. The command line interfaces for the switch can be classified into several modes. Each command mode enables you to configure different groupware. The command that can be used currently is up to the command mode where you are. You can enter the question mark in different command modes to obtain the available command list. Common command modes are listed in the following table:

Command Mode	Login Mode	Prompt	Exit Mode
System monitoring mode	Enter Ctrl-p after the power is on.	monitor#	Run quit .
User mode	Log in.	Switch>	Run exit or quit .
Management mode	Enter enter or enable in user mode.	Switch#	Run exit or quit .
Office configuration mode	Enter config in management mode.	Switch_config#	Run exit or quit or Ctrl-z to directly back to the management mode.
Port configuration mode	Enter the interface command in office configuration mode, such as interface f0/1 .	Switch_config_f0/1#	Run exit or quit or Ctrl-z to directly back to the management mode.

Each command mode is unsuitable to subsets of some commands. If problem occurs when you enter commands, check the prompt and enter the question mark to obtain the available command list. Problem may occur when you run in incorrect command mode or you misspelled the command.

Pay attention to the changes of the interface prompt and the relative command mode in the following case:

```
Switch> enter
Password: <enter password>
Switch# config
Switch_config# interface f0/1
Switch_config_f0/1# quit
Switch_config# quit
Switch#
```

3.1.3 Help Function

Use the question mark (?) and the direction mark to help you enter commands:

- Enter a question mark. The currently available command list is displayed.
Switch> ?
- Enter several familiar characters and press the space key. The available command list starting with the entered familiar characters is displayed.
Switch> s?
- Enter a command, press the space key and enter the question mark. The command parameter list is displayed.
Switch> show ?
- Press the “up” key and the commands entered before can be displayed. Continue to press the “up” key and more commands are to be displayed. After that, press the “down” key and the next command to be entered is displayed under the current command.

3.1.4 Canceling a Command

To cancel a command or resume its default properties, add the keyword “no” before most commands. An example is given as follows:

```
no ip routing
```

3.1.5 Saving Configuration

You need to save configuration in case the system is restarted or the power is suddenly off. Saving configuration can quickly recover the original configuration. You can run **write** to save configuration in management mode or office configuration mode.

Chapter 4. Basic Configuration

4.1 System Management Configuration

4.1.1 File Management Configuration

4.1.1.1 Managing the file system

The filename in flash is no more than 20 characters and filenames are case insensitive.

4.1.1.2 Commands for the file system

The boldfaces in all commands are keywords. Others are parameters. The content in the square brakcet “[]” is optional.

Command	Description
format	Formats the file system and delete all data.
Differment [filename]	Displays files and directory names. The file name in the symbol “[]” means to display files starting with several letters. The file is displayed in the following format: Index numberfile name<FILE>lengthestablished time
delete filename	Deletes a file. The system will prompt if the file does not exist.
md dirname	Creates a directory.
rd dirname	Deletes a directory. The system will prompt if the directory is not existed.
more filename	Displays the content of a file. If the file content cannot be displayed by one page, it will be displayed by pages.
cd	Changes the path of the current file system.
pwd	Displays the current path.

4.1.1.3 Starting up from a file manually

monitor#boot flash <local_filename>

The previous command is to start a switch software in the flash, which may contain multiple switch software.

- Parameter description

Parameter	Description
<i>local_filename</i>	A file name stored in the flash memory Users must enter the file name.

- Example

monitor#boot flash switch.bin

4.1.1.4 Updating software

User can use this command to download switch system software locally or remotely to obtain version update or the custom-made function version (like data encryption and so on).

There are two ways of software update in monitor mode.

a) Through TFTP

monitor#copy tftpflash [ip_addr]

The previous commad is to copy file from the tftp server to the flash in the system. After you enter the command, the system will prompt you to enter the remote server name and the remote filename.

● Parameter description

Parameter	Description
ip_addr	IP address of the tftp server If there is no specified IP address, the system will prompt you to enter the IP address after the copy command is run.

● Example

The following example shows a **main.bin** file is read from the server, written into the switch and changed into the name **switch.bin**.

monitor#copy tftp flash

Prompt: Source file name[]?main.bin

Prompt: Remote-server ip address[] ?192.168.20.1

Prompt: Destination file name [main.bin]?switch.bin

please wait ...

```
#####
#####
#####
#####
#####
#####
#####
```

TFTP: successfully receive 3377 blocks ,1728902 bytes

monitor#

b) Through serial port communication protocol - zmodem

Use the **download** command to update software. Enter **download?** to obtain help.

monitor#download c0 <local_filename>

This command is to copy the file to the flash of system through zmodem. The system will prompt you to enter the port rate after you enter the command.

- Parameter description

Parameter	Description
<i>local_filename</i>	Filename stored in the flash Users must enter the filename.

- Example

The terminal program can be the Hyper Terminal program in WINDOWS 95, NT 4.0 or the terminal emulation program in WINDOWS 3.X.

monitor#download c0 switch.bin

Prompt: speed [9600]?115200

Then, modify the rate to 115200. After reconnection, select **send file** in the transfer menu of hyper terminal (terminal emulation). The **send file** dialog box appears as follows:

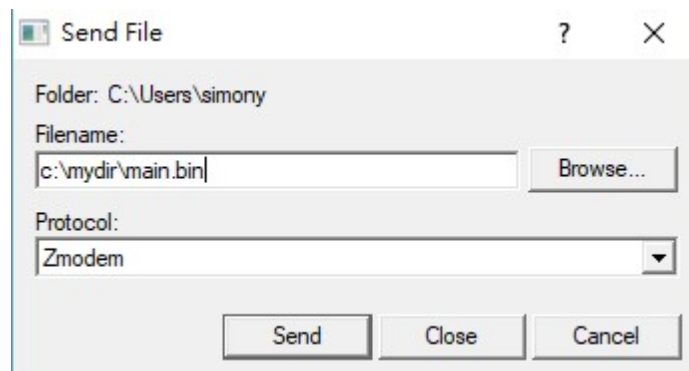

Figure 4-1 Send files

Enter the all-path of the switch software **main.bin** that our company provides in the filename input box, choose Zmodem as the protocol. Click **send** to send the file.

After the file is transferred, the following information appears:

ZMODEM: successfully receive 36 blocks ,18370 bytes

It indicates that the software update is completed, and then the baud rate of the hyper terminal should be reset to 9600.

4.1.1.5 Updating configuration

The switch configuration is saved as a file, the filename is startup-config. You can use commands similar to software update to update the configuration.

a) Through TFTP

monitor#copy tftp flash startup-config

b) Through serial port communication protocol – zmodem.

monitor#download c0 startup-config

4.1.1.6 Using ftp to perform the update of software and configuration

```
config #copy ftpflash [ip_addr|option]
```

Use ftp to perform the update of software and configuration in formal program management. Use the **copy** command to download a file from ftp server to switch, also to upload a file from file system of the switch to ftp server. After you enter the command, the system will prompt you to enter the remote server name and remote filename.

```
copy{ftp: [[[//login-name: [login-password]@]location]/directory]/filename]}flash: filename>}{flash<: filename>|ftp: [[[//login-name: [login-password]@]location]/directory]/filename}<blksize><mode><type>
```

- Parameter description

Parameter	Description
login-nam	Username of the ftp server If there is no specified username, the system will prompt you to enter the username after the copy command is run.
login-password	Password of the ftp server If there is no specified password, the system will prompt you to enter the password after the copy command is run.
nchecksize	The size of the file is not checked on the server.
vrf	Provides vrf binding function for the device that supports MPLS.
blksize	Size of the data transmission block Default value: 512
ip_addr	IP address of the ftp server If there is no specified IP address, the system will prompt you to enter the IP address after executing the copy command.
active	Means to connect the ftp server in active mode.
passive	Means to connect the ftp server in passive mode.
type	Set the data transmission mode (ascii or binary)

- Example

The following example shows a **main.bin** file is read from the server, written into the switch and changed into the name **switch.bin**.

```
config#copy ftp flash
```

```
Prompt: ftp user name[anonymous]? login-nam
```

```
Prompt: ftp user password[anonymous]? login-password
```

```
Prompt: Source file name[]?main.bin
```

Prompt: Remote-server ip address[?]192.168.20.1

Prompt: Destination file name[main.bin]?switch.bin

or

config#copy ftp: //login-nam: login-password@192.168.20.1/main.bin flash: switch.bin

#####

#####

FTP: successfully receive 3377 blocks ,1728902 bytes

config#

1. When the ftp server is out of service, the wait time is long. If this problem is caused by the tcp timeout time (the default value is 75s), you can configure the global command **ip tcp synwait-time** to modify the tcp connection time. However, it is not recommended to use it.



2. When you use ftp in some networking conditions, the rate of data transmission might be relatively slow. You can properly adjust the size of the transmission block to obtain the best effect. The default size is 512 characters, which guarantee a relatively high operation rate in most of the networks.

4.1.2 Basic System Management Configuration

4.1.2.1 Configuring Ethernet IP address

monitor#ip address <ip_addr><net_mask>

This command is to configure the IP address of the Ethernet. The default IP address is 192.168.0.254, and the network mask is 255.255.255.0.

- Parameter description

Parameter	Description
<i>ip_addr</i>	IP address of the Ethernet
<i>net_mask</i>	Mask of the Ethernet

- Example

monitor#ip address 192.168.1.1 255.255.255.0

4.1.2.2 Configuring default route

monitor#ip route default <ip_addr>

This command is used to configure the default route. You can configure only one default route.

- Parameter description

Parameter	Description
<i>ip_addr</i>	IP address of the gateway

- Example

monitor#ip route default 192.168.1.1

4.1.2.3 Using ping to test network connection state

monitor#ping <ip_address>

This command is to test network connection state.

- Parameter description

Parameter	Description
ip_address	Destination IP address

- Example

monitor#ping 192.168.20.100

PING 192.168.20.100: 56 data bytes

64 bytes from 192.168.20.100: icmp_seq=0. time=0. ms

64 bytes from 192.168.20.100: icmp_seq=1. time=0. ms

64 bytes from 192.168.20.100: icmp_seq=2. time=0. ms

64 bytes from 192.168.20.100: icmp_seq=3. time=0. ms

----192.168.20.100 PING Statistics----

4 packets transmitted, 4 packets received, 0% packet loss

round-trip (ms) min/avg/max = 0/0/0

4.1.3 HTTP Configuration

4.1.3.1 Configuring HTTP

- Enabling the http service
- Modifying the port number of the http service
- Configuring the access password of the http service
- Specifying the access control list for the http service

a) Enabling the http service

The http service is disabled by default.

The http service is enabled in the global configuration mode using the following command:

Command	Function
ip http server	Enables the http service.

b) Modifying the port number of the http service

The number of the listen port for the http service is 80.

The port number of the http service is modified in global configuration mode using the following command:

Command	Function
---------	----------

ip http port number	Modifies the port number of the http service.
---------------------	---

c) Configuring the access password of the http service

Http uses **enable** as the access password. You need to set the password **enable** if you want to perform authentication for http access. The password **enable** is set in global configuration mode using the following command:

Command	Function
Enable password {0 7} line	Sets the password enable .

d) Specifying the access control list for the http service

To control the host's access to http server, you can specify the access control list for http service. To specify an access control list, use the following command in global configuration mode:

Command	Function
ip http access-class STRING	Specifies an access control list for the http service.

4.1.3.2 Examples to http configuration

The following example uses default port (80) as the http service port, and the access address is limited to 192.168.20.0/24:

- ip acl configuration:

```
ip access-list standard http-acl
permit 192.168.20.0 255.255.255.0
```

- global configuration:

```
ip http access-class http-acl
ip http server
```

4.2 Terminal Configuration

4.2.1 VTY Configuration Introduction

The system uses the **line** command to configure terminal parameters. Through the command, you can configure the width and height that the terminal displays.

4.2.2 Configuration Task

The system has four types of lines: console, aid, asynchronous and virtual terminal. Different systems have different numbers of lines of these types. Refer to the following software and hardware configuration guide for the proper configuration.

Line Type	Interface	Description	Numbering
CON(CTY)	Console	To log in to the system for configuration.	0
VTY	Virtual and asynchronous	To connect Telnet, X.25 PAD, HTTP and Rlogin of synchronous ports (such as Ethernet and serial port) on the system	32 numbers starting from 1

4.2.2.1 Relationship between line and interface

a) Relationship between synchronous interface and VTY line

The virtual terminal line provides a synchronous interface to access to the system. When you connect to the system through VTY line, you actually connects to a virtual port on an interface. For each synchronous interface, there can be many virtual ports.

For example, if several Telnets are connecting to an interface (Ethernet or serial interface), you need to do the following steps for the VTY configuration:

- (1) Log in to the line configuration mode.
- (2) Configure the terminal parameters.

For VTY configuration, refer to Part 4.2.4 “VTY configuration example”.

4.2.3 Monitor and Maintenance

Run **showline** to chek the VTY configuration.

4.2.4 VTY Configuration Example

It shows how to cancel the limit of the line number per screen for all VTYS without **more** prompt:

```
config#line vty 0 32
config_line#length 0
```

4.3 Network Management Configuration

4.3.1 Configuring SNMP

4.3.1.1 Introduction

The SNMP system includes the following parts:

- SNMP management side (NMS)
- SNMP agent (AGENT)
- Management information base (MIB)

SNMP is a protocol working on the application layer. It provides the packet format between SNMP

management side and agent.

SNMP management side can be part of the network management system (NMS, like CiscoWorks). Agent and MIB are stored on the system. You need to define the relationship between network management side and agent before configuring SNMP on the system.

SNMP agent contains MIB variables. SNMP management side can check or modify value of these variables. The management side can get the variable value from agent or stores the variable value to agent. The agent collects data from MIB. MIB is the database of device parameter and network data. The agent also can respond to the loading of the management side or the request to configure data. SNMP agent can send trap to the management side. Trap sends alarm information to NMS indicating a certain condition of the network. Trap can point out improper user authentication, restart, link layer state(enable or disable), close of TCP connection, lose of the connection to adjacent systems or other important events.

a) SNMP notification

When some special events occur, the system will send 'inform' to SNMP management side. For example, when the agent system detects an abnormal condition, it will send information to the management side. SNMP notification can be treated as trap or inform request to send. Since the receiving side doesn't send any reply when receiving a trap, this leads to the receiving side cannot be sure that the trap has been received. Therefore the trap is not reliable. In comparison, SNMP management side that receives "inform request" uses PDU that SNMP echoes as the reply for this information. If no "inform request" is received on the management side, no echo will be sent. If the receiving side doesn't send any reply, then you can resend the "inform request". Then notifications can reach their destination.

Since inform requests are more reliable, they consume more resources of the system and network. The trap will be discarded when it is sent. The "inform request" has to be stored in the memory until the echo is received or the request timeouts. In addition, the trap is sent only once, while the "inform request" can be resent for many times. Resending "inform request" adds to network communications and causes more load on network. Therefore, trap and inform request provide balance between reliability and resource. If SNMP management side needs receiving every notification greatly, then the "inform request" can be used. If you give priority to the communication amount of the network and there is no need to receive every notification, then trap can be used.

This switch only supports trap, but we provide the extension for "inform request".

b) SNMP version

System of our company supports the following SNMP versions:

- SNMPv1---simple network management protocol, a complete Internet standard, which is defined in RFC1157.
- SNMPv2C--- Group-based Management framework of SNMPv2, Internet test protocol, which is defined in RFC1901.

Layer 3 switch of our company also supports the following SNMP:

- SNMPv3--- a simple network management protocol version 3, which is defined in RFC3410.

SNMPv1 uses group-based security format. Use IP address access control list and password to define the management side group that can access to agent MIB.

SNMPv3 provides secure access to devices by a combination of authenticating and encrypting packets over the network.

The security features provided in SNMPv3 are:

- Message integrity—Ensuring that a packet has not been tampered with in-transit.
- Authentication—Determining the message is from a valid source.
- Encryption—Scrambling the contents of a packet prevent it from being seen by an unauthorized source.

SNMPv3 provides for both security models and security levels. A security model is an authentication strategy that is set up for a user and the group in which the user resides. A security level is the permitted level of security within a security model. A combination of a security model and a security level will determine which security mechanism is employed when handling an SNMP packet. Three security models are available, that is, authentication and encryption, authentication and no encryption, no authentication.

You need to configure SNMP agent to the SNMP version that the management working station supports. The agent can communicate with many management sides.

c) Supported MIB

SNMP of our system supports all MIBII variables (which will be discussed in RFC 1213) and SNMP traps (which will be discussed in RFC 1215).

Our system provides its own MIB extension for each system.

4.3.1.2 SNMP Configuration Tasks

- Configuring SNMP view
- Creating or modifying the access control for SNMP community
- Configuring the contact method of system administrator and the system’s location
- Defining the maximum length of SNMP agent data packet
- Monitoring SNMP state
- Configuring SNMP trap
- Configuring SNMP binding source address
- Configuring NMPv3 group
- Configuring NMPv3 user
- Configuring NMPv3 EngineID

a) Configuring SNMP view

The SNMP view is to regulate the access rights (include or exclude) for MIB. Use the following command to configure the SNMP view.

Command	Description
snmp-server view <i>nameoid</i>	Adds the subtree or table of OID-specified

[exclude include]	MIB to the name of the SNMP view, and specifies the access right of the object identifier in the name of the SNMB view. Exclude: decline to be accessed Include: allow to be accessed
---------------------	---

The subsets that can be accessed in the SNMP view are the remaining objects that “include” MIB objects are divided by “exclude” objects. The objects that are not configured are not accessible by default. After configuring the SNMP view, you can implement SNMP view to the configuration of the SNMP group name, limiting the subsets of the objects that the group name can access.

b) Creating or modifying the access control for SNMP community

You can use the SNMP community character string to define the relationship between SNMP management side and agent. The community character string is similar to the password that enables the access system to log in to the agent. You can specify one or multiple properties relevant with the community character string. These properties are optional:

Allowing to use the community character string to obtain the access list of the IP address at the SNMP management side

Defining MIB views of all MIB object subsets that can access the specified community

Specifying the community with the right to read and write the accessible MIB objects

Configure the community character string in global configuration mode using the following command:

Command	Function
snmp-server community <i>string</i> [view <i>view-name</i>] [ro rw] [<i>word</i>]	Defines the group access character string.

You can configure one or multiple group character strings. Run **no snmp-server community** to remove the specified community character string.

For how to configure the community character string, refer to the part “SNMP Commands”.

c) Configuring the contact method of system administrator and the system’s location

SysContact and sysLocation are the management variables in the MIB’s system group, respectively defining the linkman’s identifier and actual location of the controlled node. These information can be accessed through **config**. files. You can use the following commands in global configuration mode.

Command	Function
snmp-server contact <i>text</i>	Sets the character string for the linkman of the node.
snmp-server location <i>text</i>	Sets the character string for the node location.

d) Defining the maximum length of SNMP agent data packet

When SNMP agent receives requests or sends respons, you can configure the maximum length of the data

packet. Use the following command in global configuration mode:

Command	Function
snmp-server packetsize <i>byte-count</i>	Sets the maximum length of the data packet.

e) Monitoring SNMP state

You can run the following command in global configuration mode to monitor SNMP output/input statistics, including illegal community character string items, number of mistakes and request variables.

Command	Function
show snmp	Monitores the SNMP state.

f) Configuring SNMP trap

Use the following command to configure the system to send the SNMP traps (the second task is optional):

- Configuring the system to send trap

Run the following commands in global configuration mode to configure the system to send trap to a host.

Command	Function
snmp-server host <i>host</i> <i>community-string</i> [<i>trap-type</i>]	Specifies the receiver of the trap message.
snmp-server host <i>host</i> [<i>traps</i> <i>informs</i>]{ <i>version</i> { <i>v1</i> <i>v2c</i> <i>v3</i> { <i>auth</i> <i>noauth</i> <i>priv</i> } }} <i>community-string</i> [<i>trap-type</i>]	Specifies the receiver, version number and username of the trap message. Note: For the trap of SNMPv3, you must configure SNMP engine ID for the host before the host is configured to receive the trap message.

When the system is started, the SNMP agent will automatically run. All types of traps are activated. You can use the command **snmp-server host** to specify which host will receive which kind of trap.

Some traps need to be controlled through other commands. For example, if you want SNMP link traps to be sent when an interface is opened or closed, you need to run **snmp trap link-status** in interface configuration mode to activate link traps. To close these traps, run the **interface configuration** command **snmp trap link-stat**.

You have to configure the command **snmp-server host** for the host to receive the traps.

- Modifying the running parameter of the trap

As an optional item, it can specify the source interface where traps originate, queue length of message or value of resending interval for each host.

To modify the running parameters of traps, you can run the following optional commands in global configuration mode.

Command	Function
---------	----------

snmp-server trap-source <i>interface</i>	Specifies the source interface where traps originate and sets the source IP address for the message.
snmp-server queue-length <i>length</i>	Creates the queue length of the message for each host that has traps. Default value: 10
snmp-server trap-timeoutseconds	Defines the frequency to resend traps in the resending queue. Default value: 30 seconds

g) Configuring the SNMP binding source address

Run the following command in the global configuration mode to set the source address for the SNMP message.

Command	Function
snmp source-addr <i>ipaddress</i>	Sets the source address for the SNMP message.

h) Configuring SNMPv3 group

Run the following command to configure a group.

Command	Function
snmp-server group [<i>groupname</i> { v1 v2c v3 [auth noauth priv]}][read <i>readview</i>][write <i>writeview</i>][notify <i>notifyview</i>][access <i>access-list</i>]	Configures a SNMPv3 group. You can only read all items in the subtree of the Internet by default.

i) Configuring SNMPv3 user

You can run the following command to configure a local user. When an administrator logs in to a device, he has to use the username and password that are configured on the device. The security level of a user must be higher than or equals to that of the group which the user belongs to. Otherwise, the user cannot pass authentication.

Command	Function
snmp-server user username groupname { v1 v2c v3 [encrypted] [auth { md5 sha } <i>auth-password</i>]} [access <i>access-list</i>]	Configures a local SNMPv3 user.

You can run the following command to configure a remote user. When a device requires to send traps to a

remote control station, a remote user has to be configured if the control station performs ID authentication. Username and password of the remote user must be the same as those on the control station. Otherwise, the control station cannot receive traps.

Command	Function
snmp-server user username groupname remote ip-address [udp-port port] {v1 v2c v3 [encrypted] [auth {md5 sha} auth-password]} [access access-list]	Configures a remote SNMPv3 user. Note: A remote SNMP engine ID must be configured for the control station of the IP address before a remote user is configured.

j) Configuring SNMPv3 Engine ID

The SNMP Engine ID is to identify an SNMP engine. Traditional SNMP manager and agent are part of the SNMP engine in the SNMPv3 frame.

Command	Function
snmp-server engineID remote ip-address [udp-port port-number] engineid-string	Configures a remote SNMP engine.

4.3.1.3 Configuration example

a) Example 1

```
snmp-server community public RO
snmp-server community private RW
snmp-server host 192.168.10.2 public
```

The above example shows:

- how to set the community string **public** that can only read all MIB variables.
- how to set the community string **private** that can read and write all MIB variables.

You can use the community string **public** to read MIB variables in the system. You can also use the community string **private** to read MIB variables and write writable MIB variables in the system.

The above command specifies the community string **public** to send traps to 192.168.10.2 when a system requires to send traps. For example, when a port of a system is in the **down** state, the system will send a **linkdown** trap information to 192.168.10.2.

b) Example 2

```
snmp-server engineID remote 90.0.0.3 80000523015a000003
snmp-server group getter v3 auth
snmp-server group setter v3 priv write v-write
snmp-server user get-user getter v3 auth sha 12345678
snmp-server user set-user setter v3 encrypted auth md5 12345678
```



```
snmp-server user notifier getter remote 90.0.0.3 v3 auth md5 abcdefghi
snmp-server host 90.0.0.3 informs version v3 auth notifier
snmp-server view v-write internet included
```

The above example shows how to use SNMPv3 to manage devices. Group getter can browse device information, while group setter can set devices. User get-user belongs to group getter while user set-user belongs to group setter.

For user **get-user**, its security level is **authenticate but not encrypt**, its password is **12345678**, and it uses the sha arithmetic to summarize the password.

For user **set-user**, its security level is **authenticate and encrypt**, its password is **12345678**, and it uses the md5 arithmetic to summarize the password.

When key events occur at a device, use username **notifier** to send **inform** messages to host 90.0.0.3 of the administrator.

4.3.2 RMON Configuration

4.3.2.1 RMON configuration task

RMON configuration tasks include:

- Configuring the rMon alarm function for the switch
- Configuring the rMon event function for the switch
- Configuring the rMon statistics function for the switch
- Configuring the rMon history function for the switch
- Displaying the rMon configuration of the switch

a) Configuring rMon alarm for switch

You can configure the rMon alarm function through the command line or SNMP NMS. If you configure through SNMP NMS, you need to configure the SNMP of the switch. After the alarm function is configured, the device can monitor some statistic value in the system. The following table shows how to set the rMon alarm function:

Command	Function
configure	Enter the global configuration mode.
rmon alarm indexvariable <i>interval</i> { absolute delta } rising-threshold <i>value</i> [<i>eventnumber</i>] falling-threshold <i>value</i> [<i>eventnumber</i>] [ownerstring]	Add a rMon alarm item. index is the index of the alarm item. Its effective range is from 1 to 65535. variable is the object in the monitored MIB. It must be an effective MIB object in the system. Only objects in the Integer, Counter, Gauge or TimeTicks type can be detected. interval is the time section for sampling. Its unit is second. Its effective value is from 1 to 4294967295.

	<p>absolute is used to directly monitor the value of MIB object. delta is used to monitor the value change of the MIB objects between two sampling. value is the threshold value when an alarm is generated. eventnumber is the index of an event that is generated when a threshold is reached. eventnumber is optional. owner string is to describe the information about the alarm.</p>
exit	Enter the management mode again.
write	Save the configuration.

After a rMon alarm item is configured, the device will obtain the value of variable-specified oid after an interval. The obtained value will be compared with the previous value according to the alarm type (absolute or delta). If the obtained value is bigger than the previous value and surpasses the threshold value specified by **rising-threshold**, an event whose index is **eventnumber** (If the value of **eventnumber** is 0 or the event whose index is **eventnumber** does not exist in the event table, the event will not occur). If the variable-specified oid cannot be obtained, the state of the alarm item in this line is set to **invalid**. If you run **rmon alarm** many times to configure alarm items with the same index, only the last configuration is effective. You can run **no rmon alarm index** to cancel alarm items whose indexes are **index**.

b) Configuring eMon event for switch

The steps to configure the rMon event are shown in the following table:

Step	Command	Purpose
1.	configure	Enter the global configuration mode.
2.	rmon event index [<i>descriptionstring</i>] [log] [<i>ownerstring</i>] [trap community]	<p>Add a rMon event item.</p> <p>index means the index of the event item. Its effective range is from 1 to 65535.</p> <p>description means the information about the event.</p> <p>log means to add a piece of information to the log table when a event is triggered.</p> <p>trap means a trap message is generated when the event is triggered. community means the name of a community.</p> <p>owner string is to describe the information about the alarm.</p>
3.	exit	Enter the management mode again.
4.	write	Save the configuration.

After a rMon event is configured, you must set the domain **eventLastTimeSent** of the rMon event item to **sysUpTime** when a rMon alarm is triggered. If the **log** attribute is set to the rMon event, a message is added

to the log table. If the **trap** attribute is set to the rMon event, a trap message is sent out in name of community. If you run **rmon event** many times to configure event items with the same index, only the last configuration is effective. You can run **no rmon event index** to cancel event items whose indexes are **index**.

c) Configuring rMon statistics for switch

The rMon statistics group is used to monitor the statistics information on every port of the device. The steps to configure the rMon statistics are as follows:

Step	Command	Purpose
1.	configure	Enter the global configuration mode.
2.	interface iftype ifid	Enter the port mode. iftype means the type of the port. ifid means the ID of the interface.
3.	rmon collection stat index [ownerstring]	Enable the statistics function on the port. index means the index of the statistics. owner string is to describe the information about the statistics.
4.	exit	Enter the global office mode.
5.	exit	Enter the management mode again.
6.	write	Save the configuration.

If you run **rmon collection stat** many times to configure statistics items with the same index, only the last configuration is effective. You can run **no rmon collection stats index** to cancel statistics items whose indexes are **index**.

d) Configuring rMon history for switch

The rMon history group is used to collect statistics information of different time sections on a port in a device. The rMon statistics function is configured as follows:

Step	Command	Purpose
1.	configure	Enter the global configuration command.
2.	interface iftype ifid	Enter the port mode. iftype means the type of the port. ifid means the ID of the interface.
3.	rmon collection history index [buckets bucket-number] [interval second] [owner owner-name]	Enable the history function on the port. index means the index of the history item. Among all data collected by history item, the latest bucket-number items need to be saved. You can browse the history item of the Ethernet to obtain these statistics values. The default value is 50 items. second means the interval to obtain the statistics data every other time. The default value is 1800

		seconds. owner string is used to describe some information about the history item.
4.	exit	Enter the global office mode again.
5.	exit	Enter the management mode again.
6.	write	Save the configuration.

After a rMon history item is added, the device will obtain statistics values from the specified port every **second** seconds. The statistics value will be added to the history item as a piece of information. If you run **rmon collection history index** many times to configure history items with the same index, only the last configuration is effective. You can run **no rmon history index** to cancel history items whose indexes are **index**.



Too much system sources will be occupied in the case the value of **bucket-number** is too big or the value of **interval second** is too small.

e) Displaying rMon configuration of switch

Run **show** to display the rMon configuration of the switch.

Command	Purpose
show rmon [alarm] [event] [statistics] [history]	Displays the rmon configuration information. alarm means to display the configuration of the alarm item. event means to show the configuration of the event item and to show the items that are generated by the occurrence of events and are contained in the log table. statistics means to display the configuration of the statistics item and statistics values that the device collects from the port. history means to display the configuration of the history item and statistics values that the device collects in the latest specified intervals from the port.

4.3.3 Configuring PDP

4.3.3.1 Introduction

PDP is a two-layer protocol specially used to detect network devices. PDP is used in Network Management Service (NMS) to detect all neighboring devices of a already known device. Using PDP enable you to learn the SNMP agent address and the types of neighboring devices. After neighboring devices are detected through PDP, the NMS can require neighboring devices through SNMP to obtain the network topology.

Our switches can detect neighboring devices through PDP, but cannot require neighboring devices through SNMP. Therefore, these switches have to be located at the verge of networks. Otherwise, the complete network topology cannot be obtained.

PDP on switches can be configured on all SANPs, such as Ethernet.

4.3.3.2 PDP configuration tasks

- Default PDP configuration of the switch
- Setting the PDP clock and information saving time
- Setting the PDP version
- Enabling the PDP on the switch
- Enabling the PDP on the port of the switch
- Monitoring and managing PDP

a) Default PDP configuration of the switch

Function	Default Setting
PDP global configuration state	Disabled
PDP port configuration state	Disabled
PDP clock (frequency for sending messages)	60 seconds
PDP information saving	180 seconds
PDP version	2

b) Setting the PDP clock and information saving time

Run the following commands in global configuration mode to set the frequency for PDP to send messages and the PDP information saving time:

Command	Purpose
pdp timer <i>seconds</i>	Sets the frequency for PDP to send messages.
pdp holdtime<i>seconds</i>	Sets the PDP information saving time.

c) Setting the PDP version

Run the following command in global configuration mode to set the PDP version:

Command	Purpose
pdp version {1 2}	Sets the PDP version.

d) Enabling PDP on the switch

PDP is not enabled in the default configuration. If you want to use PDP, run the following command in global configuration mode.

Command	Purpose
---------	---------

pdp run	Enables the PDP on the switch.
----------------	--------------------------------

e) Enabling PDP on the port of the switch

PDP is not enabled in the default configuration. You can run the following command in interface configuration mode to enable PDP on the port after PDP is enabled on the switch.

Command	Purpose
pdp enable	Enables PDP on the port of the switch.

f) Monitoring and managing PDP

Run the following commands in management mode to monitor PDP:

Command	Purpose
show pdp traffic	Displays the number of PDP messages that the switch receives and sends.
show pdp neighbor [detail]	Displays neighboring devices that the switch detects through PDP.

4.3.3.3 PDP configuration examples

Example 1: Enabling PDP

```
config# pdp run
config# int f0/0
config_f0/0#pdp enable
```

Example 2: Setting the PDP clock and information saving time

```
config#pdp timer 30
config#pdp holdtime 90
```

Example 3: Setting the PDP version

```
config#pdp version 1
```

Example 4: Monitoring PDP information

```
config#show pdp neighbors
```

Capability Codes: R - Router, T - Trans Bridge, B - Source Route Bridge S - Switch, H -

Host, I - IGMP, r - Repeater

Device ID Local InfrfceHoldtmeCapabilityPlatform Port ID

```
joeEth 0 133 4500 Eth 0
```

```
samEth 0 152 R AS5200 Eth 0
```

SSH Configuration commands

4.3.4 Introduction

4.3.4.1 SSH server

A scure and encrypted communication connection can be created between SSH client and the device through SSH server. The connection has telnet-like functions. SSH server supports the encryption algorithms

including des, 3des and blowfish.

4.3.4.2 SSH client

SSH client is an application running under the ssh protocol. SSH client can provide authentication and encryption, so SSH client gurantees secure communication between communication devices or devices supporting SSH server even if these devices run in unsafe network conditions. SSH client supports the encryption algorithms including des, 3des and blowfish.

4.3.4.3 Function

SSH server and SSH client supports version 1.5. Both of them only support the shell application.

4.3.5 Configuration Tasks

4.3.5.1 Configuring the authentication method list

SSH server adopts the login authentication mode. SSH server uses the **default** authentication method list by default.

Run the following command in global configuration command mode to configure the authentication method list:

Command	Purpose
Ip sshd auth_method STRING	Configures the authentication method list.

4.3.5.2 Configuring the access control list

To control the access to the device's SSH server, you need to configure the access control list for SSH server.

Run the following command in global configuration mode to configure the access control list:

Command	Purpose
Ip sshd access-class STRING	Configures the access control list.

4.3.5.3 Configuring the authentication timeout value

After a connection is established between client and server, server cuts off the connection if authentication cannot be approved within the set time.

Run the following command in global configuration mode to configure the configuration timeout value:

Command	Purpose
Ip sshd timeout <60-65535>	Configures the authentication timeout value.

4.3.5.4 Configuring the times of authentication retrying

If the times for failed authentications exceed the maximum times, SSH server will not allow you to retry authentication unless a new connction is established. The maximum times for retrying authentication is 3 by default.

Run the following command in global configuration mode to configure the maximum times for retrying authentication:

Command	Purpose
Ip sshd auth-retries <0-65535>	Configures the maximum times for retrying authentication.

4.3.5.5 Enabling SSH server

SSH server is disabled by default. When SSH server is enabled, the device will generate a rsa password pair, and then listen connection requests from the client. The process takes one or two minutes.

Run the following command in global configuration mode to enable SSH server:

Command	Purpose
Ip sshd enable	Enables SSH server. The digit of the password is 1024.

4.3.6 SSH server Configuration Example

The following configuration only allows the host whose IP address is 192.168.20.40 to access SSH server. The local user database is used to distinguish user ID.

4.3.6.1 Access control list

```
ip access-list standard ssh-acl
permit 192.168.20.40
```

4.3.6.2 Global configuration

```
aaa authentication login ssh-auth local
ip sshd auth-method ssh-auth
ip sshd access-class ssh-acl
ip sshd enable
```

Chapter 5. Network Management Configuration

5.1 Network Management Configuration

5.1.1 SNMP Configuration

5.1.2 Overview

The SNMP system includes the following 3 parts:

- SNMP management server (NMS)
- SNMP agent (agent)
- MIB

SNMP is a protocol for the application layer. It provides the format for the packets which are transmitted between NMS and agent.

SNMP management server is a part of the network management system, such as CiscoWorks.

SNMP agent includes the MIB variable and the SNMP management server can be used to browse or change these variables' values. The management server can get the values from the agent or save these variables in the agent. The agent collects data from MIB. MIB is the database of equipment parameters and network data.

5.1.3 SNMP Notification

When a special event occurs, the system will send an inform to the SNMP management server. For example, when the agent system runs into an incorrect condition, it will send a message to the management server.

The SNMP notification can be sent as a trap or an inform request. Because the receiver receives a trap and does not send any response, the transmitter hence cannot confirm whether the trap is received. In this way, the trap is unreliable. Comparatively, the SNMP management server uses SNMP to respond PDU, which is acted as a response of this message. If the management server does not receive the inform request, it will not transmit a response. If the transmitter does not receive the response, it will transmit the inform request again. In this way, the inform has more chance to arrive the planned destination.

5.1.4 SNMP Tasks

- Configuring idle time value
- Configuring the time value of waiting for acknowledgement
- Configuring busy time value of remote end
- Configuring time value of Response
- Configuring the time of reject
- Configuring the redial times
- Configuring the size of window for resend
- Configuring the size of accumulated data packet

- Setting the acknowledgement time-delay
- Setting the maximum numbers of acknowledgement
- Showing LLC2 link information
- Debugging LLC2 link information

5.2 LLC2 Configuration Tast

5.2.1 Configuring Idle Time Value

The command is used for controlling the frequency of query at the idle time (no data exchanged)

The command “no” can be used for restoring to the default value.

Command	Purpose
[no] llc2 idle-time [seconds]	Used for controlling the frequency of query at the idle time (no data exchanged). seconds: The interval seconds of sending RR frame at the idle time. The maximum is 60 seconds, the minimum is 1 second, and the default is 10 seconds.

Configuration mode: Interface Configuration



At idle time, no I (information) frame is exchanged and RR (receive ready) frame is sent to the remote end periodically to tell the remote end that the local end is ready to receive data. The relative small value should be set for ensuring the prompt advice to the remote end. If the value is set too small, too many RR frames is likely to be sent on the network.

Example: Setting RR frame sent every 12 seconds

```
int ethernet1/1
llc2 idle-time 12
```

5.2.2 Configuring the Time Value of Waiting for Acknowledgement

Command	Purpose
[no] llc2 t1-time [seconds]	Used for controlling the waiting time of expecting remote acknowledgement. The command “no” can be used for restoring to the default value. Seconds The seconds of waiting for remote acknowledgement. The maximum is 60 seconds, the minimum is 1 second and the default is 1 second.

Configuration mode: Interface configuration



When the local end sends I frame, it will wait for remote acknowledgement. If no acknowledgement is received within a given time, the I-frame will be resent. The relative big value should be set on the network where the data is transmitted at a slow rate.

Example: Setting 12 seconds as the time value of waiting for acknowledgement.

```
int ethernet1/1
llc2 t1-time 12
```

5.2.3 Configuring Busy Time Value of Remote Terminal

Command	Purpose
[no] llc2 tbusy-time [seconds]	Used for controlling the waiting time when the remote end is busy. The command “no” can be used for restoring to the default value. Seconds The waiting seconds when the remote end is busy. The maximum is 60 seconds, the minimum is 1 second and the default is 10 seconds.

Configuration mode: Interface configuration



a LLC2 connective end is able to inform the opposite end that local end is busy and prevent the opposite end from sending data to local end by sending a RNR (receive not ready) The relative big value can be set for averting the timeout.

Example: Setting 12 seconds as the busy time value of remote end.

```
int ethernet 1/1
llc2 tbusy-time 12
```

5.2.4 Configuring Time Value of Response

The command is used for controlling the time of waiting for the response of remote end. The command “no” can be used for restoring to the default value.

Command	Purpose
[no] llc2 tpf-time [seconds]	used for controlling the time of waiting for the response of remote end. The command “no” can be used for restoring to the default value. Seconds: The seconds of waiting for the response of remote end. The maximum is 60 seconds, the minimum is 1 second, and the

	default is 1 second.
--	----------------------

Configuration Mode: Interface Configuration

A LLC2 connective end sometimes needs to know the status of opposite end. For this purpose, a command frame that requires a response from the opposite end needs to be sent. When the opposite end receives the command frame, it will reply a response frame. If the error occurs in the process, the send end will keep waiting. In order to avoid the situation, a clock needs to be enabled. When the arrival time is hit, the clock will think that the error occurs and it will send a separate command frame. The command is used for setting the time of waiting for the response of the opposite end to the command frame.



Example: Setting 12 seconds as the time of waiting for the response of the opposite end.

```
int ethernet1/1
llc2 tpf-time 12
```

5.2.5 Configuring the Time of Rejection

The command is

Command	Purpose
[no] llc2 trej-time [seconds]	Used for controlling the time of waiting for the response of remote end to the reject frame. The command "no" can be used for restoring to the default value. Seconds: The seconds of waiting when the remote end is busy. The maximum is 60 seconds, the minimum is 1 second and the default is 3 seconds.

Configuration mode: Interface configuration

The data receive and send on the two ends of LLC2 link is carried out on the set sequence. When a LLC2 connective end receives I frame of opposite end whose sequence number is not the expected one, it will send a REJ (reject) frame and enable a clock. If no response is made at the arrival time, LLC2 link will be disconnected. The command is used for setting the time of waiting for the response of the opposite end to the REJ (reject) frame.



Example: Setting 12 seconds as the waiting time.

```
int ethernet 1/1
llc2 trej-time 12
```

5.2.6 Configuring the Redial Times

The command is

Command	Purpose
[no] llc2 n2 retry-count	Used for controlling the times of re-sending the frame. The command "no" can be used for restoring to the default value. retry-count: The times of resending frame. The maximum is 255, the minimum is 1 and the default is 8.

Configuration mode: Interface configuration



When one end of LLC2 sends the data to the opposite end, it will wait for the acknowledgement of the opposite end. If the opposite end does not send the acknowledgement within a given time, the local end will resend the data. But the time of resend shall be limited. When the value of resend times exceeds retry-count, LLC2 will be disconnected. The command is used for setting the times of retry-count.

Example: Setting the times of re-send as 12

```
int ethernet 1/1
```

```
llc2 n2 12
```

5.2.7 Configuring the Size of Window for Resending

The command is

Command	Purpose
[no] llc2 local-window packet-count	Used for controlling the maximum size of I frame send (namely the size of window for resend) when I frame is not confirmed. The command "no" can be used for restoring to the default value. packet-count: The maximum size of I frame send. The maximum is 127, the minimum is 1 and the default is 7.

Configuration mode: Interface configuration



When one end of LLC2 link sends data to the opposite end, it can only send a certain amount of data before waiting for the acknowledgement of the opposite end. The command is used for setting the maximum value. When the set value is too big, it may lead to the loss of data because the opposite end is not able to receive all the data.

Example: Setting the size of send window as 12.

```
int ethernet 1/1
llc2 local-window 12
```

5.2.8 Configuring the Size of Accumulated Data Packet

The command is

Command	Purpose
[no] llc2 holdqueue [packet-count]	Used for controlling the maximum local accumulated size of data packet when I frame (the remote end is busy) cannot be sent. The command “no” can be used for restoring to the default value. packet-count: The maximum size of data packets reserved by I frame when I frame is not confirmed.

Configuration mode: Interface configuration



When the opposite end is busy, one end of LLC2 link is not able to send data (I frame). All the data shall be reserved before the busyness of the opposite end is cleared. But the reserved amount is limited. The command is used for setting the data amount to be reserved.

Example: Setting maximum data amount to be reserved as 120.

```
int ethernet 1/1
llc2 holdqueue 120
```

5.2.9 Setting the Acknowledgement Time-Delay

When an I-frame (information frame) is received, an acknowledgement frame shall be sent immediately. In order to reduce the unnecessary acknowledgement, the acknowledgement can be delayed. If information frame is sent, an information frame will be sent as an acknowledgement instead of acknowledge frame. When the information frame sent by the opposite end exceeds the acknowledged maximum size, an acknowledge frame will be sent immediately rather than at the timeout. The command below can be used for setting the value.

Command	Purpose
llc2 ack-delay-time <i>seconds</i>	Setting the acknowledgement time-delay

5.2.10 Setting the Maximum Numbers of Acknowledgement

When the information frame sent by the opposite end exceeds the maximum number of acknowledgement in the process of acknowledging the time delay, the acknowledgement frame shall be sent immediately for

clearing the network timeout perceived by the opposite end. The command below can be used for setting the value.

Command	Purpose
llc2 ack-maxnumber	Setting the acknowledgement time-delay.

5.2.11 Showing LLC2 Link Information

Command	Purpose
show llc interface [type number]	Used for showing the related information of LLC2 link connection.

Configuration Mode: Interface, configuration and global



Showing the related information of LLC2 link connection. Under interface mode, the command “show llc” is used for displaying LLC2 link information of the interface.

Example: Under interface mode, the command “show llc” is used for showing llc2 information on ethernet1/1.

```
int ethernet 1/1
sho llc ethernet 1/1
```

5.2.12 Debugging LLC2 Link Information

The command is

Command	Purpose
debug llc2 [packet error state]	Used for opening LLC2 debug switch.

Configuration mode: Management Mode



Packet, Opening the debug switch of LLC2 link status information

Example, opening the debug switch of LLC2 link.

```
debug llc2 packet
debug llc2 state
debug llc2 error
```

5.2.13 Example of LLC2 Configuration

The number of LLC2 frame received before the response can be configured. For example, it is supposed that two information frames are received at the time 0 rather than at the maximum number 3, the responses of these frames are not sent. If the third frame that makes the router response is not received within 800 ms, the

response will be transmitted as the time-delay timer is activated.

```
interface interface e1/1
```

```
llc2 ack-max 3
```

```
llc2 ack-delay-time 800
```

In this connection, as it is told that all the frames are received, the counter that calculates the maximum number of information frame is reset as 0.

5.2.14 Configuring SDLC as Two-Way and Concurrent Mode

SDLC two-way and concurrent mode allows master SDLC link station to use a full duplex serial circuit. When an outstanding polling occurs, the master SDLC link station is able to send the data to the slave station. The two-way and concurrent mode works only on the side of SDLC master station. In the slave link station, it response to the polling sent from the master station.

SDLC two-way and concurrent mode runs in the multi-branch link environment or point-to-point link environment.

In the multi-branch link environment, a two-way and concurrent master station is able to poll a slave station and receive the data from the slave station and send the data (information frame) to other slave stations.

In the point-to-point link environment, so long as no maximum limit on reaching the window, a two-way and concurrent master station is able to send the data (information frame) to the slave station even if there is an outstanding polling.

Any one of the commands can be used under interface configuration mode for activating the two-way and concurrent mode:

Command	Purpose
sdlc simultaneous full-datamode	Setting the send of data from master station to the polled slave station and receive of data from it.
sdlc simultaneous half-datamode	Shutting down the master station sending the data to the slave station.

5.2.15 Configuring SDLC Timer and Re-Sending Times

When SDLC workstation sends frame, it will wait for the response of receive end. The response indicates the frame has been received. The response time allowed by the router before re-sending frame can be amended. The times of re-sending the frame by the software can be set before terminating SDLC session process. Through controlling these values, by controlling these values, the network overhead can be reduced in continuing to detect the transmitted frame.

One or two commands below can be used under interface configuration mode for configuring SDLC timer and retransmission times:

Command	Purpose
sdlc t1 milliseconds	Controlling the total time of software of waiting for response.

sdlc n2retry-count	Configuring the times of software of retrying a timeout operation.
---------------------------	--

5.2.16 Configuring the Number of SDLC Frame and Information Frame

The maximum length of input frame and the maximum number of the information frame (or the size of window) received before router sends response to the receive end can be configured. When the configured value is relative big, the network overhead can be reduced.

The command below can be used under interface configuration mode for configuring SDLC frame and number of information frame.

Command	Purpose
sdlc n1 bit-count	Configuring the maximum length of input frame
sdlc kwindow-size	Configuring the size of local window of router
sdlc poll-limit-valuecount	Configuring the times of master station's polling to the slave station.

5.2.17 Controlling the Size of Cache

The size of cache can be controlled. The cache is used for storing the data that is not decided to be sent to remote SDLC station. The command is especially useful in SDLC protocol convert equipment that implements the communication between SNA workstation whose link layer protocol is LLC2 in token-ring local area network (LAN) and SNA workstation whose link layer protocol is SDLC on serial link. The frame length and the size of window on the token-ring are usually much bigger than the acceptable ones on the serial link. What's more, the serial link is slower than token-ring.

In order to control the accumulation problem produced in the high-speed data transmission from token-ring to serial link, the command below can be used on the basis of each address under interface configuration mode:

Command	Purpose
sdlc holdqueue address queue-size	Setting the maximum quantity of the data packets stored in the sequence before transmission.

5.2.18 Controlling the polling of slave station

The interval of router's polling to the slave station, the length of time of sending data from master station to slave station and how long the software polls a slave station before moving to the next station can be controlled.

The following points should be noted in using these commands:

Only when the slave station is polled by the master station, the data can be transmitted. When the polling terminates and the value of timer is too big, the response time of slave station will add. When the value of the timer is reduced too small, it will lead to the congestion of serial link and data flood due to the excessive and unnecessary polling frames sent from the slave station, which takes the extra CPU time for dealing with them.

The communication efficiency between master station and single slave station can be improved by increasing the limit value of polling, but it may delay the polling to other slave stations.

One or more commands below can be used under interface configuration mode for controlling the polling of slave station:

Command	Purpose
sdhc poll-pause-timer <i>milliseconds</i>	Configuring the waiting time interval of router's polling to two slave stations on some single serial port.
sdhc poll-limit-value count	Configuring the times of a master station's polling to slave station.

The "def" format of these commands can be used for restoring to the default polling value.

5.2.19 Configuring SDLC Interface as Half-Duplex Mode

Under default state, SDLC interface runs under full duplex mode. The command below can be used under interface configuration mode for configuring SDLC interface as half-duplex mode.

Command	Purpose
half-duplex	Configuring SDLC interface as half-duplex mode.

5.2.20 Configuring XID Value

XID value set in the router shall be consistent with the corresponding parameter set on token-ring host with which SDLC equipment will communicate and shall match with the corresponding system parameter in IDBLK and IDNUM defined in VTAM of token ring host.



Configuring XID value will affect the attribute of the interface. If XID value is configured, it means that the equipment connected with the interface is Pu2.0. XID value can be configured after the port is shut down.

The command below can be used under interface configuration mode for configuring XID value.

Command	Purpose
sdhc xid address xid	Designating XID value related to SDLC station.

5.2.21 Configuring the Maximum Value of SDLC Information Frame

Normally, the router and SDLC equipment that interacts with router protocol shall support the same and maximum length of SDLC information frame. The bigger the value is, the more efficient the link is used and the performance will be better.

After SDLC equipment is configured with the maximum possible information frame to be sent, the router shall be configured for supporting the same maximum length of information frame. The default value is 265 bytes. The maximum value supported by the software must be smaller than the maximum frame value of LLC2

defined at the time of configuring the maximum length of LLC2 information frame.

The command below can be used under interface configuration mode for configuring the maximum value of SDLC information frame:

Command	Purpose
sdhc sdhc-largest-frameaddress size	Configuring the maximum length of information frame that can be sent or received by the designated SDLC station.

5.2.22 Monitoring SDLC Workstation

The command below can be used under management mode for monitoring the configuration of SDLC workstation and deciding which SDLC parameter needs to be adjusted.

Command	Purpose
show interfaces	Showing configuration information of SDLC workstation.

Chapter 6. Security Configuration

6.1 AAAConfiguration

6.1.1 AAA Overview

Access control is the way to control access to the network and services. Authentication, authorization, and accounting (AAA) network security services provide the primary framework through which you set up access control on your router or access server.

6.1.1.1 AAA Security Service

AAA is an architectural framework for configuring a set of three independent security functions in a consistent manner. AAA provides a modular way of performing the following services:

- Authentication—Provides the method of identifying users, including login and password dialog, challenge and response, messaging support, and, depending on the security protocol you select, encryption.

Authentication is the way a user is identified prior to being allowed access to the network and network services. You configure AAA authentication by defining a named list of authentication methods, and then applying that list to various interfaces. The method list defines the types of authentication to be performed and the sequence in which they will be performed; it must be applied to a specific interface before any of the defined authentication methods will be performed. The only exception is the default method list (which is named "default"). The default method list is automatically applied to all interfaces if no other method list is defined. A defined method list overrides the default method list.

All authentication methods, except for local, line password, and enable authentication, must be defined through AAA. For information about configuring all authentication methods, including those implemented outside of the AAA security services, refer to the chapter "Configuring Authentication."

- Authorization—Provides the method for remote access control, including one-time authorization or authorization for each service, per-user account list and profile, user group support, and support of IP, IPX, ARA, and Telnet.

AAA authorization works by assembling a set of attributes that describe what the user is authorized to perform. These attributes are compared to the information contained in a database for a given user and the result is returned to AAA to determine the user's actual capabilities and restrictions. The database can be located locally on the access server or router or it can be hosted remotely on a RADIUS or TACACS+ security server. Remote security servers, such as RADIUS and TACACS+, authorize users for specific rights by associating attribute-value (AV) pairs, which define those rights with the appropriate user. All authorization methods must

be defined through AAA.

As with authentication, you configure AAA authorization by defining a named list of authorization methods, and then applying that list to various interfaces. For information about configuring authorization using AAA, refer to the chapter "Configuring Authorization."

- Accounting—Provides the method for collecting and sending security server information used for billing, auditing, and reporting, such as user identities, start and stop times, executed commands (such as PPP), number of packets, and number of bytes.

Accounting enables you to track the services users are accessing as well as the amount of network resources they are consuming. When AAA accounting is activated, the network access server reports user activity to the RADIUS or TACACS+ security server (depending on which security method you have implemented) in the form of accounting records. Each accounting record is comprised of accounting AV pairs and is stored on the access control server. This data can then be analyzed for network management, client billing, and/or auditing. All accounting methods must be defined through AAA. As with authentication and authorization, you configure AAA accounting by defining a named list of accounting methods, and then applying that list to various interfaces. For information about configuring accounting using AAA, refer to the chapter "Configuring Accounting."

6.1.1.2 Benefits of Using AAA

AAA provides the following benefits:

- Increased flexibility and control of access configuration
- Scalability
- Standardized authentication methods, such as RADIUS, TACACS+, and Kerberos
- Multiple backup systems

6.1.1.3 AAA Principles

AAA is designed to enable you to dynamically configure the type of authentication and authorization you want on a per-line (per-user) or per-service (for example, IP, IPX, or VPDN) basis. You define the type of authentication and authorization you want by creating method lists, then applying those method lists to specific services or interfaces.

6.1.1.4 Method Lists

A method list is a sequential list that defines the authentication methods used to authenticate a user. Method lists enable you to designate one or more security protocols to be used for authentication, thus ensuring a backup system for authentication in case the initial method fails. Cisco IOS software uses the first method listed to authenticate users; if that method does not respond, Cisco IOS software selects the next authentication method in the method list. This process continues until there is successful communication with

a listed authentication method or the authentication method list is exhausted, in which case authentication fails.

The software attempts authentication with the next listed authentication method only when there is no response from the previous method. If authentication fails at any point in this cycle—meaning that the security server or local username database responds by denying the user access—the authentication process stops and no other authentication methods are attempted. The following figures shows a typical AAA network configuration that includes four security servers: R1 and R2 are RADIUS servers, and T1 and T2 are TACACS+ servers.

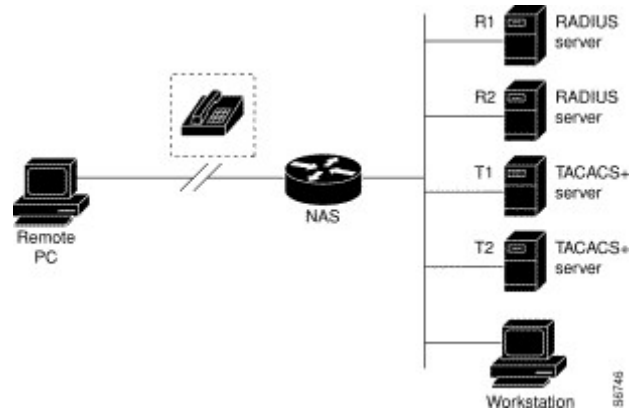

Figure 6-1 Typical AAA Network Configuration

Suppose the system administrator has defined a method list where R1 will be contacted first for authentication information, then R2, T1, T2, and finally the local username database on the access server itself. When a remote user attempts to dial in to the network, the network access server first queries R1 for authentication information. If R1 authenticates the user, it issues a PASS response to the network access server and the user is allowed to access the network. If R1 returns a FAIL response, the user is denied access and the session is terminated. If R1 does not respond, then the network access server processes that as an ERROR and queries R2 for authentication information. This pattern continues through the remaining designated methods until the user is either authenticated or rejected, or until the session is terminated. If all of the authentication methods return errors, the network access server will process the session as a failure, and the session will be terminated.

A FAIL response is significantly different from an ERROR. A FAIL means that the user has not met the criteria contained in the applicable authentication database to be successfully authenticated. Authentication ends with a FAIL response. An ERROR means that the security server has not responded to an authentication query. Because of this, no authentication has been attempted. Only when an ERROR is detected will AAA select the next authentication method defined in the authentication method list.

6.1.2 AAA Configuration Process

You must first decide what kind of security solution you want to implement. You need to assess the security risks in your particular network and decide on the appropriate means to prevent unauthorized entry and attack.

6.1.2.1 Overview of the AAA Configuration Process

Configuring AAA is relatively simple after you understand the basic process involved. To configure security on a Cisco router or access server using AAA, follow this process:

- If you decide to use a separate security server, configure security protocol parameters, such as RADIUS, TACACS+, or Kerberos.
- Define the method lists for authentication by using an AAA authentication command.
- Apply the method lists to a particular interface or line, if required.
- (Optional) Configure authorization using the AAA authorization command.
- (Optional) Configure accounting using the AAA accounting command.

6.1.3 AAA Authentication Configuration Task List

- Configuring Login Authentication Using AAA
- Configuring PPP Authentication Using AAA
- Enabling Password Protection at the Privileged Level
- Configuring Message Banners for AAA Authentication
- AAA authentication username-prompt
- AAA authentication password-prompt
- Establishing Username Authentication
- Enabling Password

6.1.4 AAA Authentication Configuration Task

To configure AAA authentication, perform the following configuration processes:

1. If you decide to use a separate security server, configure security protocol parameters, such as RADIUS, TACACS+, or Kerberos.
2. Define the method lists for authentication by using an AAA authentication command.
3. Apply the method lists to a particular interface or line, if required.

6.1.4.1 Configuring Login Authentication Using AAA

The AAA security services facilitate a variety of login authentication methods. Use the `aaa authentication login` command to enable AAA authentication no matter which of the supported login authentication methods you decide to use. With the `aaa authentication login` command, you create one or more lists of authentication methods that are tried at login. These lists are applied using the login authentication line configuration command.

To configure login authentication by using AAA, use the following commands beginning in global configuration mode:

Command	Purpose
<code>aaa authentication login {default </code>	Enables AAA globally.

<i>list-name</i> }method1 [<i>method2</i> ...]	
line [console vty] <i>line-number</i> [<i>ending-line-number</i>]	Enters line configuration mode for the lines to which you want to apply the authentication list.
login authentication {default <i>list-name</i> }	Applies the authentication list to a line or set of lines.

The list-name is a character string used to name the list you are creating. The method argument refers to the actual method the authentication algorithm tries. The additional methods of authentication are used only if the previous method returns an error, not if it fails. To specify that the authentication should succeed even if all methods return an error, specify none as the final method in the command line.

For example, to specify that authentication should succeed even if (in this example) the TACACS+ server returns an error, enter the following command:

```
aaa authentication login default group radius
```



Because the none keyword enables any user logging in to successfully authenticate, it should be used only as a backup method of authentication.

The following table lists the supported login authentication methods.:

Keyword	description
enable	Uses the enable password for authentication.
group <i>name</i>	Uses named server group for authentication.
group radius	Uses the list of all RADIUS servers for authentication.
line	Uses the line password for authentication.
local	Uses the local username database for authentication.
local-case	Uses case-sensitive local username authentication.
none	Uses no authentication.

(1) Login Authentication Using Enable Password

Use the aaa authentication login command with the enable method keyword to specify the enable password as the login authentication method. For example, to specify the enable password as the method of user authentication at login when no other method list has been defined, enter the following command:

```
aaa authentication login default enable
```

(2) Login Authentication Using Line Password

Use the aaa authentication login command with the line method keyword to specify the line password as the login authentication method. For example, to specify the line password as the method of user authentication at login when no other method list has been defined, enter the following command:

```
aaa authentication login default line
```

Before you can use a line password as the login authentication method, you need to define a line password.

(3) Login Authentication Using Local Password

Use the `aaa authentication login` command with the `local` method keyword to specify that the Cisco router or access server will use the local username database for authentication. For example, to specify the local username database as the method of user authentication at login when no other method list has been defined, enter the following command:

```
aaa authentication login default local
```

For information about adding users into the local username database, refer to the section "Establishing Username Authentication" in this chapter.

(4) Login Authentication Using Group RADIUS

Use the `aaa authentication login` command with the `group radius` method to specify RADIUS as the login authentication method. For example, to specify RADIUS as the method of user authentication at login when no other method list has been defined, enter the following command:

```
aaa authentication login default group radius
```

Before you can use RADIUS as the login authentication method, you need to enable communication with the RADIUS security server. For more information about establishing communication with a RADIUS server, refer to the chapter "Configuring RADIUS."

6.1.4.2 Enabling Password Protection at the Privileged Level

Use the `aaa authentication enable default` command to create a series of authentication methods that are used to determine whether a user can access the privileged EXEC command level. You can specify up to four authentication methods. The additional methods of authentication are used only if the previous method returns an error, not if it fails. To specify that the authentication should succeed even if all methods return an error, specify `none` as the final method in the command line.

Use the following command in global configuration mode:

Command	Purpose
<code>aaa authentication enable defaultmethod1 [method2...]</code>	Enables user ID and password checking for users requesting privileged EXEC level.

The method argument refers to the actual list of methods the authentication algorithm tries, in the sequence entered.

The following table lists the supported enable authentication methods.

Keyword	Description
<code>enable</code>	Uses the enable password for authentication.
<code>group group-name</code>	Uses a subset of RADIUS or TACACS+ servers for authentication as defined by the <code>aaa group server radius</code> or <code>aaa group server tacacs+</code> command.
<code>group radius</code>	Uses the list of all RADIUS hosts for authentication.

line	Uses the line password for authentication.
none	Uses no authentication.

6.1.4.3 Configuring Message Banners for AAA Authentication

AAA supports the use of configurable, personalized login and failed-login banners. You can configure message banners that will be displayed when a user logs in to the system to be authenticated using AAA and when, for whatever reason, authentication fails.

6.1.4.4 Configuring a Login Banner

To configure a banner that will be displayed whenever a user logs in (replacing the default message for login), use the following commands in global configuration mode: :

Command	Purpose
aaa authentication banner <i>delimiter text-string delimiter</i>	Creates a personalized login banner.

6.1.4.5 Configuring a Failed-Login Banner

To configure a message that will be displayed whenever a user fails login (replacing the default message for failed login), use the following commands in global configuration mode: :

Command	Purpose
aaa authentication fail-message <i>delimiter text-string delimiter</i>	Creates a message to be displayed when a user fails login.

6.1.4.6 Instruction

To create a login banner, you need to configure a delimiting character, which notifies the system that the following text string is to be displayed as the banner, and then the text string itself. The delimiting character is repeated at the end of the text string to signify the end of the banner. The delimiting character can be any single character in the extended ASCII character set, but once defined as the delimiter, that character cannot be used in the text string making up the banner.

6.1.4.7 AAA authentication username-prompt

To change the text displayed when users are prompted to enter a username, use the aaa authentication username-prompt command in global configuration mode. To return to the default username prompt text, use the no form of this command. username:

The aaa authentication username-prompt command does not change any dialog that is supplied by a remote TACACS+ server. Use the following command to configure in global configuration mode:

Command	Purpose
---------	---------

aaa authentication username-prompt <i>text-string</i>	String of text that will be displayed when the user is prompted to enter an username.
--	---

6.1.4.8 AAA authentication password-prompt

To change the text displayed when users are prompted for a password, use the aaa authentication password-prompt command in global configuration mode. To return to the default password prompt text, use the no form of this command.

password:

The aaa authentication password-prompt command does not change any dialog that is supplied by a remote TACACS+ server. Use the following command to configure in global configuration mode:

Command	Purpose
aaa authentication password-prompt <i>text-string</i>	String of text that will be displayed when the user is prompted to enter a password.

6.1.4.9 Establishing Username Authentication

You can create a username-based authentication system, which is useful in the following situations:

- To provide a TACACS-like username and encrypted password-authentication system for networks that cannot support TACACS
- To provide special-case logins: for example, access list verification, no password verification, autocommand execution at login, and "no escape" situations

To establish username authentication, use the following commands in global configuration mode as needed for your system configuration:

Use the no form of this command to delete a username.

username *name* {**nopassword** | **password** *password* | **password** **encryption-type** *encrypted-password*}

username *name* [**autocommand** *command*]

username *name* [**callback-dial** *string* *telephone-number*]

username *name* [**callback-rotary** *rotary-group-number*]

username *name* [**callback-line** [**tty** | **aux**] *line-number* [*ending-line-number*]]

username *name* [**noescape**] [**nohangup**]

username *name* [**privilege** *level*]

username *name* [**user-maxlinks** *number*]

no username *name*

6.1.4.10 Enabling password

To set a local password to control access to various privilege levels, use the enable password command in global configuration mode. To remove the password requirement, use the no form of this command.

enable password { [*encryption-type*] *encrypted-password*} [*level level*]

no enable password [*level level*]

6.1.5 AAA Authentication Configuration Example

6.1.5.1 RADIUS Authentication Example

This section provides one sample configuration using RADIUS.

The following example shows how to configure the switch to authenticate and authorize using RADIUS:

```
aaa authentication login radius-login group radius local
```

```
aaa authorization network radius-network radius
```

```
line vty
```

```
login authentication radius-login
```

The lines in this sample RADIUS authentication and authorization configuration are defined as follows: :

- The `aaa authentication login radius-login radius local` command configures the router to use RADIUS for authentication at the login prompt. If RADIUS returns an error, the user is authenticated using the local database.
- The `aaa authentication ppp radius-ppp radius` command configures the software to use PPP authentication using CHAP or PAP if the user has not already logged in. If the EXEC facility has authenticated the user, PPP authentication is not performed.
- The `aaa authorization network radius-network radius` command queries RADIUS for network authorization, address assignment, and other access lists.
- The `login authentication radius-login` command enables the radius-login method list for line 3.

6.1.6 AAA Authorization Configuration Task List

- Configuring EXEC Authorization using AAA

6.1.7 AAA Authorization Configuration Task

To configure AAA authorization, perform the following configuration processes:

- (1) If you decide to use a separate security server, configure security protocol parameters, such as RADIUS, TACACS+, or Kerberos.
- (2) Define the method lists for authorization by using an AAA authorization command.
- (3) Apply the method lists to a particular interface or line, if required.

6.1.7.1 Configuring EXEC Authorization Using AAA

Use the `aaa authorization` command to enable authorization

Use `aaa authorization exec` command to run authorization to determine if the user is allowed to run an EXEC shell. This facility might return user profile information such as autocommand information.

Use line configuration command `login authentication` to apply these lists. Use the following command in global configuration mode:

Command	Purpose
<code>aaa authorization exec {default <i>list-name</i>}<i>method1</i> [<i>method2</i>...]</code>	Establishes global authorization list.
<code>line [console vty] <i>line-number</i> [<i>ending-line-number</i>]</code>	Enters the line configuration mode for the lines to which you want to apply the authorization method list.
<code>login authorization {default <i>list-name</i>}</code>	Applies the authorization list to a line or set of lines(in line configuration mode).

The keyword `list-name` is the character string used to name the list of authorization methods.

The keyword `method` specifies the actual method during authorization process. Method lists enable you to designate one or more security protocols to be used for authorization, thus ensuring a backup system in case the initial method fails. The system uses the first method listed to authorize users for specific network services; if that method fails to respond, the system selects the next method listed in the method list. This process continues until there is successful communication with a listed authorization method, or all methods defined are exhausted. If all specified methods fail to respond, and you still want the system to enter the EXEC shell, you should specify `none` as the last authorization method in command line.

Use default parameter to establish a default list, and the default list will apply to all interfaces automatically.

For example, use the following command to specify radius as the default authorization method for exec:

```
aaa authorization exec default group radius
```



If no method list is defined, the local authorization service will be unavailable and the authorization is allowed to pass.

The following table lists the currently supported EXEC authorization mode:

Keyword	Description
<code>group</code> <i>WORD</i>	Uses a named server group for authorization.
<code>group radius</code>	Uses radius authorization.
<code>local</code>	Uses the local database for authorization.
<code>if-authenticated</code>	Allows the user to access the requested function if the user is authenticated.
<code>none</code>	No authorization is performed.

6.1.8 AAA Authorization Example

EXEC local authorization example

```
aaa authentication login default local
```

```
aaa authorization exec default local
```

!

```
username exec1 password 0 abc privilege 15
username exec2 password 0 abc privilege 10
username exec3 nopassword
username exec4 password 0 abc user-maxlinks 10
username exec5 password 0 abc autocommand telnet 172.16.20.1
!
```

The lines in this sample RADIUS authorization configuration are defined as follows: :

- The aaa authentication login default local command defines the default method list of login authentication. This method list applies to all login authentication servers automatically.
- The aaa authorization exec default local command defines default method list of exec authorization. The method list automatically applies to all users that need to enter exec shell.
- Username is exec1 , login password is abc , EXEC privileged level is 15(the highest level) , that is, when user exec1 whose privileged level is 15 logs in exec shell, all commands can be checked and performed.
- Username is exec2 , login password is abc , EXEC privileged level is 10 ,that is, when user exec2 whose privileged level is 10 logs in EXEC shell, commands with privileged level less than 10 can be checked and performed.
- Username is exec3 , no password is needed for login.
- Username is exec4 , login password is abc , the maximum links of the user is 10.
- Username is exec5 , login password is abc, user performs telnet 172.16.20.1 immediately when logging in exec shell.

6.1.9 AAA Accounting Configuration Task List

- Configuring Connection Accounting using AAA
- Configuring Network Accounting using AAA

6.1.10 AA Accounting Configuration Task

To configure AAA accounting, perform the following configuration processes:

- (1) If you decide to use a separate security server, configure security protocol parameters, such as RADIUS, TACACS+, or Kerberos.
- (2) Define the method lists for accounting by using an AAA accounting command.
- (3) Apply the method lists to a particular interface or line, if required.

6.1.10.1 Configuring Accounting Connection Using AAA

Use the **aaa accounting** command to enable AAA accounting.

To create a method list to provide accounting information about all outbound connections made from the network access server, use the **aaa accounting connection** command.

Command	Purpose
---------	---------

aaa accounting connection {default <i>list-name</i> } {start-stop stop-only none} group <i>groupname</i>	Establishes global accounting list.
--	-------------------------------------

The keyword list-name is used to name any character string of the establishing list. The keyword method specifies the actual method adopted during accounting process.

The following table lists currently supported connection accounting methods:

Keyword	Description
group <i>WORD</i>	Enables named server group for accounting.
group radius	Enables radius accounting.
none	Disables accounting services for the specified line or interface.
stop-only	Sends a "stop" record accounting notice at the end of the requested user process.
start-stop	RADIUS or TACACS+ sends a "start" accounting notice at the beginning of the requested process and a "stop" accounting notice at the end of the process.

6.1.10.2 Configuring Network Accounting Using AAA

Use the aaa accounting command to enable AAA accounting.

To create a method list to provide accounting information for SLIP, PPP, NCPs, and ARAP sessions, use the aaa accounting network command in global configuration mode.

Command	Purpose
aaa accounting network {default <i>list-name</i> } {start-stop stop-only none} group <i>groupname</i>	Enables global accounting list.

The keyword list-name is used to name any character string of the establishing list. The keyword method specifies the actual method adopted during accounting process.

The following table lists currently supported network accounting methods:

Keyword	Description
group <i>WORD</i>	Enables named server group for accounting.
group radius	Enables radius accounting.
none	Disables accounting services for the specified line or interface.
stop-only	Sends a "stop" record accounting notice at the end of the requested user process.
start-stop	RADIUS or TACACS+ sends a "start" accounting notice at the beginning of the requested process and a "stop" accounting notice at the end of the process.

6.1.10.3 AAA Accounting Update

To enable periodic interim accounting records to be sent to the accounting server, use the `aaa accounting update` command in global configuration mode. To disable interim accounting updates, use the `no` form of this command.

Command	Purpose
<code>aaa accounting update [newinfo] [periodicnumber]</code>	Enables AAA accounting update.

If the `newinfo` keyword is used, interim accounting records will be sent to the accounting server every time there is new accounting information to report. An example of this would be when IP Control Protocol (IPCP) completes IP address negotiation with the remote peer. The interim accounting record will include the negotiated IP address used by the remote peer.

When used with the `periodic` keyword, interim accounting records are sent periodically as defined by the argument number. The interim accounting record contains all of the accounting information recorded for that user up to the time the accounting record is sent.

When using both the `newinfo` and `periodic` keywords, interim accounting records are sent to the accounting server every time there is new accounting information to report, and accounting records are sent to the accounting server periodically as defined by the argument number. For example, if you configure the `aaa accounting update newinfo periodic number` command, all users currently logged in will continue to generate periodic interim accounting records while new users will generate accounting records based on the `newinfo` algorithm.

6.1.10.4 AAA accounting suppress null-username

To prevent the AAA system from sending accounting records for users whose username string is NULL, use the `aaa accounting suppress null-username` command in global configuration mode. To allow sending records for users with a NULL username, use the `no` form of this command.

- `aaa accounting suppress null-username`

6.2 Configuring RADIUS

This chapter describes the Remote Authentication Dial-In User Service (RADIUS) security system, defines its operation, and identifies appropriate and inappropriate network environments for using RADIUS technology. The "RADIUS Configuration Task List" section describes how to configure RADIUS with the authentication, authorization, and accounting (AAA) command set.

6.2.1 Introduction

6.2.1.1 RADIUS Introduction

RADIUS is a distributed client/server system that secures networks against unauthorized access. In the implementation, RADIUS clients run on switches and send authentication requests to a central RADIUS

server that contains all user authentication and network service access information.

RADIUS has been implemented in a variety of network environments that require high levels of security while maintaining network access for remote users.

Use RADIUS in the following network environments that require access security: :

- Networks with multiple-vendor access servers, each supporting RADIUS. For example, access servers from several vendors use a single RADIUS server-based security database. In an IP-based network with multiple vendors' access servers, dial-in users are authenticated through a RADIUS server that has been customized to work with the Kerberos security system.
- Networks in which a user must only access a single service. Using RADIUS, you can control user access to a single host, to a single utility such as Telnet, or to a single protocol such as Point-to-Point Protocol (PPP). For example, when a user logs in, RADIUS identifies this user as having authorization to run PPP using IP address 10.2.3.4 and the defined access list is started.
- Networks that require resource accounting. You can use RADIUS accounting independent of RADIUS authentication or authorization. The RADIUS accounting functions allow data to be sent at the start and end of services, indicating the amount of resources (such as time, packets, bytes, and so on) used during the session. An Internet service provider (ISP) might use a freeware-based version of RADIUS access control and accounting software to meet special security and billing needs.

RADIUS is not suitable in the following network security situations:

- Multiprotocol access environments. RADIUS does not support the following protocols:
- AppleTalk Remote Access (ARA)
- NetBIOS Frame Control Protocol (NBFCP)
- NetWare Asynchronous Services Interface (NASI)
- X.25 PAD connections
- Switch-to-switch situations. RADIUS does not provide two-way authentication.
- Networks using a variety of services. RADIUS generally binds a user to one service model.

6.2.1.2 RADIUS Operation

When a user attempts to log in and authenticate to an access server using RADIUS, the following steps occur:

- (1) The user is prompted for and enters a username and password.
- (2) The username and encrypted password are sent over the network to the RADIUS server.
- (3) The user receives one of the following responses from the RADIUS server:
 - a. ACCEPT—the user is authenticated.
 - b. REJECT—the user is not authenticated and is prompted to reenter the username and password, or access is denied.
 - c. CHALLENGE—a challenge is issued by the RADIUS server. The challenge collects additional data from the user.
 - d. CHANGE PASSWORD—a request is issued by the RADIUS server, asking the user to select a new

password.

The ACCEPT or REJECT response is bundled with additional data that is used for EXEC or network authorization. You must first complete RADIUS authentication before using RADIUS authorization. The additional data included with the ACCEPT or REJECT packets consists of the following:

Services that the user can access, including Telnet, rlogin, or local-area transport (LAT) connections, and PPP, Serial Line Internet Protocol (SLIP), or EXEC services.

Connection parameters, include the host or client IP address, access list, and user timeouts.

6.2.2 RADIUS Configuration Task List

To configure RADIUS on your switch or access server, you must perform the following tasks:

- Use the `aaa authentication global configuration` command to define method lists for RADIUS authentication. For more information about using the `aaa authentication` command, refer to the "Configuring Authentication" chapter.
- Use line and interface commands to enable the defined method lists to be used. For more information, refer to the "Configuring Authentication" chapter.
- The following configuration tasks are optional:
- You may use the `aaa authorization global` command to authorize specific user functions. For more information about using the `aaa authorization` command, refer to the chapter "Configuring Authorization."
- You may use the `aaa accounting` command to enable accounting for RADIUS connections. For more information about using the `aaa accounting` command, refer to the chapter "Configuring Accounting."

6.2.3 RADIUS Configuration Task List

- Configuring Switch to RADIUS Server Communication
- Configuring Switch to Use Vendor-Specific RADIUS Attributes
- Specifying RADIUS Authentication
- Specifying RADIUS Authorization
- Specifying RADIUS Accounting

6.2.4 RADIUS Configuration Task

6.2.4.1 Configuring Switch to RADIUS Server Communication

The RADIUS host is normally a multiuser system running RADIUS server software from Livingston, Merit, Microsoft, or another software provider.

A RADIUS server and a Cisco router use a shared secret text string to encrypt passwords and exchange responses.

To configure RADIUS to use the AAA security commands, you must specify the host running the RADIUS server daemon and a secret text (key) string that it shares with the router.

To configure per-server RADIUS server communication, use the following command in global configuration mode:

Command	Purpose
<code>radius-server hostip-address [auth-portport-number][acct-portportnumber]</code>	Specifies the IP address or host name of the remote RADIUS server host and assign authentication and accounting destination port numbers.
<code>radius-server keystring</code>	Specifies the shared secret text string used between the router and a RADIUS server.

To configure global communication settings between the router and a RADIUS server, use the following radius-server commands in global configuration mode:

Command	Purpose
<code>radius-server retransmitretries</code>	Specifies how many times the switch transmits each RADIUS request to the server before giving up (the default is 2).
<code>radius-server timeout seconds</code>	Specifies for how many seconds a switch waits for a reply to a RADIUS request before retransmitting the request.
<code>radius-server deadtime minutes</code>	Specifies for how many minutes a RADIUS server that is not responding to authentication requests is passed over by requests for RADIUS authentication.

6.2.4.2 Configuring Switch to Use Vendor-Specific RADIUS Attributes

The Internet Engineering Task Force (IETF) draft standard specifies a method for communicating vendor-specific information between the network access server and the RADIUS server by using the vendor-specific attribute (attribute 26).

Vendor-specific attributes (VSAs) allow vendors to support their own extended attributes not suitable for general use.

For more information about vendor-IDs and VSAs, refer to RFC 2138, Remote Authentication Dial-In User Service (RADIUS). To configure the network access server to recognize and use VSAs, use the following command in global configuration mode:

Command	Purpose
<code>radius-servervsa send [authentication]</code>	Enables the network access server to recognize and use VSAs as defined by RADIUS IETF attribute 26.

6.2.4.3 Specifying RADIUS Authentication

After you have identified the RADIUS server and defined the RADIUS authentication key, you must define method lists for RADIUS authentication. Because RADIUS authentication is facilitated through AAA, you must enter the `aaa authentication` command, specifying RADIUS as the authentication method. For more information, refer to the chapter "Configuring Authentication."

6.2.4.4 Specifying RADIUS Authorization

AAA authorization lets you set parameters that restrict a user's access to the network. Authorization using RADIUS provides one method for remote access control, including one-time authorization or authorization for each service, per-user account list and profile, user group support, and support of IP, IPX, ARA, and Telnet. Because RADIUS authorization is facilitated through AAA, you must issue the `aaa authorization` command, specifying RADIUS as the authorization method. For more information, refer to the chapter "Configuring Authorization."

6.2.4.5 Specifying RADIUS Accounting

The AAA accounting feature enables you to track the services users are accessing as well as the amount of network resources they are consuming. Because RADIUS accounting is facilitated through AAA, you must issue the `aaa accounting` command, specifying RADIUS as the accounting method. For more information, refer to the chapter "Configuring Accounting."

6.2.5 RADIUS Configuration Examples

6.2.5.1 RADIUS Authentication and Authorization Example

The following example shows how to configure the router to authenticate and authorize using RADIUS:

```
aaa authentication login use-radius group radius local
```

The lines in this sample RADIUS authentication and authorization configuration are defined as follows: :

`aaa authentication login use-radius radius local` configures the router to use RADIUS for authentication at the login prompt. If RADIUS returns an error, the user is authenticated using the local database. In this example, `use-radius` is the name of the method list, which specifies RADIUS and then local authentication.

RADIUS Authentication, Authorization, and Accounting Example

The following example shows a general configuration using RADIUS with the AAA command set: :

```
radius-server host 1.2.3.4
radius-server key myRaDiUSpassWoRd
username root password AlongPassword
aaa authentication login admins radius local
line vty 1 16
login authentication admins
```

The lines in this example RADIUS authentication, authorization, and accounting configuration are defined as follows: :

radius-server host command defines the IP address of the RADIUS server host. ;

radius-server key command defines the shared secret text string between the network access server and the RADIUS server host.

aaa authentication login admins **group radius** local command defines the authentication method list "dialins," which specifies that RADIUS authentication and then (if the RADIUS server does not respond) local authentication will be used on serial lines using PPP. ;

login authentication admins command applies the "admins" method list for login authentication.

6.2.5.2 RADIUS Application Example

The following example shows how to define the general configuration through the AAA command set:

```
radius-server host 1.2.3.4
radius-server key myRaDiUSpassWoRd
username root password AlongPassword
aaa authentication login admins radius local
line vty 1 16
login authentication admins
```

In the example above, each command line has its own meaning. See the following content:

The command **radius-server host** defines the IP address of the RADIUS server.

The command **radius-server key** defines the shared pin between the network access server and the RADIUS server.

The command **aaa authentication login admins radius local** defines the authentication method list **admins**, which first specifies RADIUS as the authentication method and then uses the local authentication if the RADIUS server does not respond.

The command login authentication admins specifies the method list admins as the login authentication method.

6.3 Web Authentication Configuration

The section describes the concept of Web authentication and configuration and usage of the Web authentication.

6.3.1 Overview

6.3.1.1 Web Authentication

The Web authentication of the switch is a connection control mode as PPPoE and 802.1x. When you use the Web authentication, the login and logout operations can be successfully performed through the interaction of the browser and the builtin portal server of the switch. During the operations of login and logout, no other client software need be installed.

1. Device role

The roles that the network devices take during the Web authentication are shown in Figure 6-2:

- **Client:** It is a user computer that accesses network through the switch. The user computer need be configured the network browser, the function of DHCP client and the function to originate DNS query.
- **DHCP server:** It is to distribute the IP address for users.
- **AAA server:** It is to save user right information and to charge users for their network access.
- **Switch:** It is a switch having Web authentication. It is to control the access right of users and works as an agent between users and AAA server.

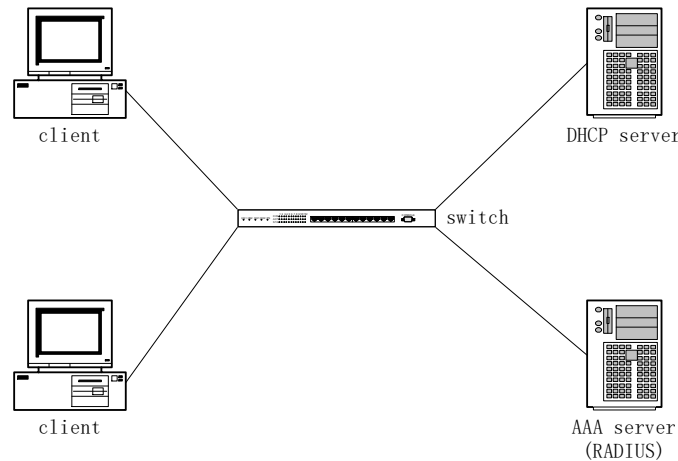

Figure 6-2 Web authentication network

2. Authentication flow

According to different configuration strategies, the Web authentication flow of the switch may relate to protocols such as DHCP and DNS. Its typical flow is shown in Figure 3-2. The Web authentication flow generally contains the following steps:

- (1) The DHCP server sends a DHCP confirmation request to a user through the switch after the user originates the process of DHCP address distribution. The switch then identifies and records the user.
- (2) The user accesses any Website through the browser (Write down the domain name, not the IP address, in the host part of the **url** column in the browser), which activates the DNS request of the user computer.
- (3) The DNS server returns the user a request response. The switch captures the request response message and changes the resolved address to the address of the built-in portal server in the switch.
- (4) The DHCP confirmation process continues after the browser captures DNS resolution. The switch returns the corresponding authentication page according to different authentication methods after the switch receives the request.
- (5) The user submits the authentication request; the switch authenticates the user through the AAA server after the switch receives information submitted by the user; if the authentication succeeds, the AAA server will be notified to start charging; the switch gives the user the network access right and returns the user a page that the authentication is successful; meanwhile, the switch also returns a **keep alive** page, which periodically sends the **user online** notification to the switch.
- (6) The user sends the logout request to the switch through the browser. The switch then notifies the AAA server to stop charging, and withdraws the network access right from the user.
- (7) In the period between successful user authentication and logout, the switch periodically detects the user

online notification. If the notification is not received in the preset time, the switch considers that the user abnormally logs off, notifies the AAA server to stop charging and withdraws the network access right from the user.

The above steps may vary a little with configuration strategies and user's operations. For example, if user directly accesses the portal server of the switch before the authentication is approved, DNS-related processes will not be enabled.

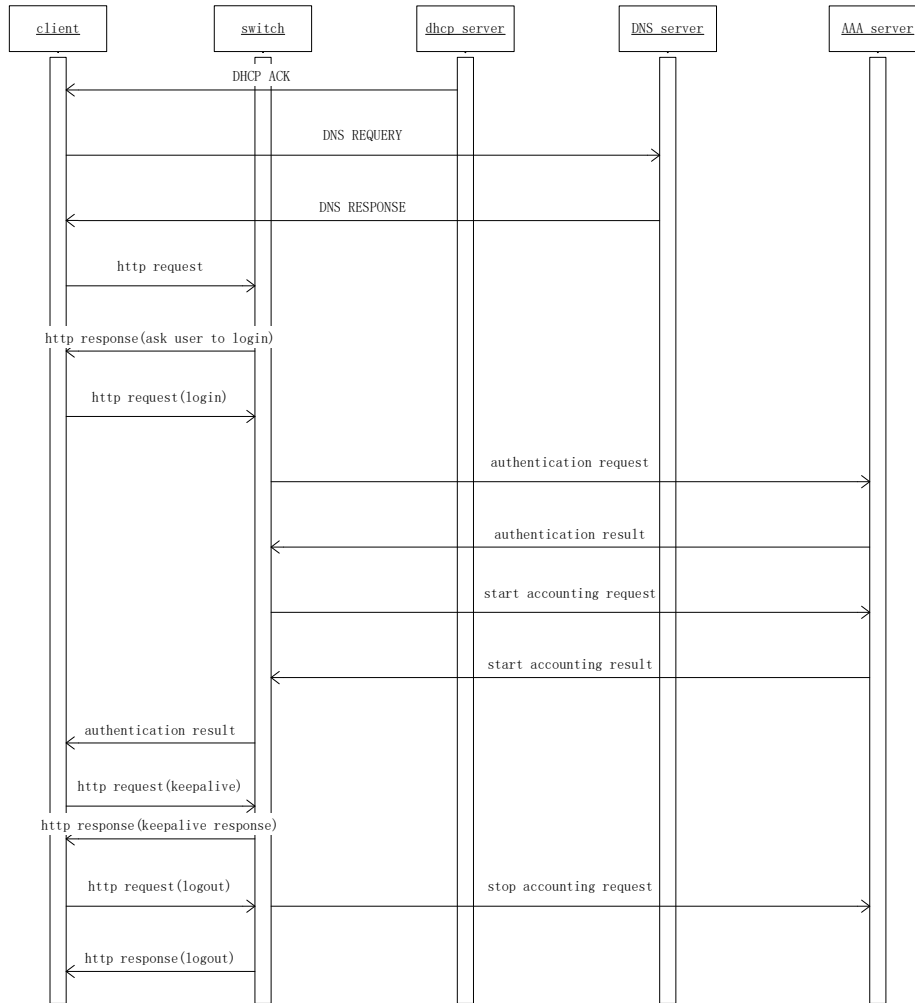

Figure 6-3 web authentication flow

6.3.1.2 Planning Web Authentication

1. Planning the authentication mode

Two authentication modes are provided to control user's access:

Username/password authentication mode: In this mode, the switch identifies the user through the username and password, and notifies the AAA server to start charging according to username; user needs to enter the username and password through the browser.

VLAN ID authentication mode: In this mode, the switch identifies the user through the VLAN ID the user belongs to, and notifies the AAA server to start charging according to VLAN ID; user only requires to confirm corresponding operations on the Web page before accessing the network.

Different operation strategies adopt different authentication modes. The supported maximum number of users that simultaneously access the network varies with the authentication mode. For the username/password authentication mode, the switch supports simultaneously accessed users as many as its performance permits. For the VLAN ID authentication mode, the maximum number of simultaneously accessed users equals the number of VLAN that the switch supports.

2. Planning network topology

The switch takes the routing interface as a unit to set the authentication attribute. If the web authentication function is enabled on a routing interface, network accesses through the routing interface are all controlled by the web authentication. The DHCP server, DNS server or AAA server should connect the switch through the interface with web authentication function disabled. Figure 6-4 shows the relative typical network topology.

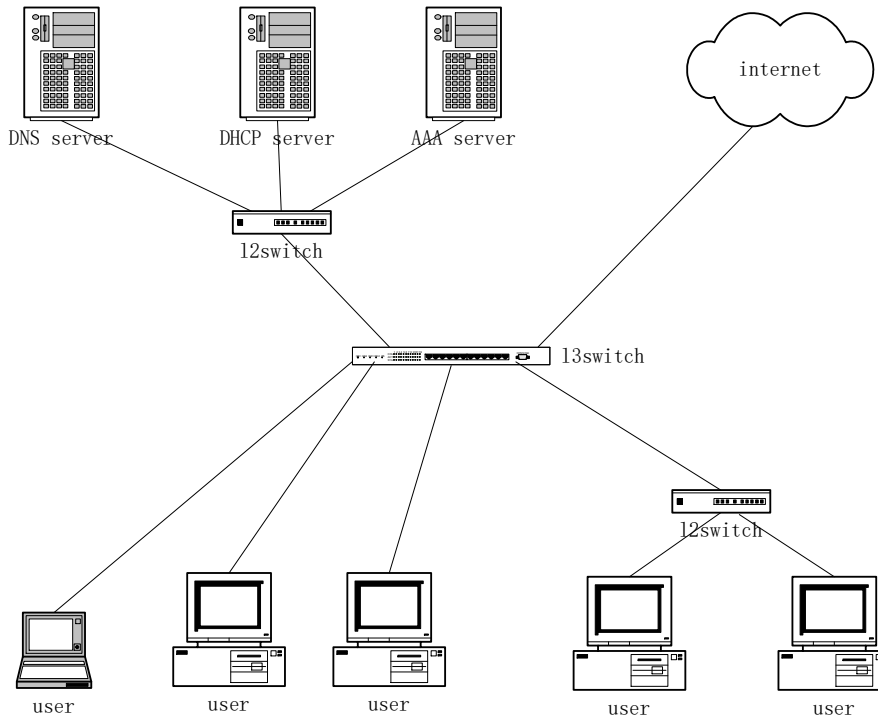

Figure 6-4 Typical network topology

6.3.2 Configuring Web Authentication

6.3.2.1 Global Configuration

1. Configuring the address of the portal server

Run the following command in global configuration mode to configure the address of the portal server:

Run...	To...
web-auth portal-server A.B.C.D	Configure the IP address of the portal server.

2. Configuring authentication duration

The parameter **authtime** determines the maximum time of user's authentication. If the authentication is not approved within the maximum time, the switch terminates the authentication procedure.

Run the following command in global configuration mode to configure the authentication duration (Unit: second):

Run...	To...
web-auth authtime <60-65535>	Configure the authentication duration.

3. Configuring the transmission period of the online notification

Through the online notification sent by the browser, the switch checks whether the user is online.

Run the following command in global configuration mode to configure the transmission period (unit: second):

Run...	To...
web-auth keep-alive<60-65535>	Configure the transmission period for the online notification.

4. Configuring the duration to detect the abnormal logout

When the switch does not receive the user online notification from the browser in the set duration, the switch considers that user logs out abnormally.

Run the following command in global configuration mode to configure the duration to detect the abnormal logout:

Run...	To...
web-auth holdtime <60-65535>	Configure the duration to detect user's abnormal logout.

5. Configuring password for the VLAN ID authentication

When the authentication mode is set to VLAN ID, the switch takes **vlan n** as the user name, **n** representing the corresponding VLAN serial number. All user names use the same password.

Run the following command in global configuration mode to configure the password for the VLAN ID authentication:

Run...	To...
web-auth vlan-password <WORD>	Configure the password for the VLAN ID authentication.

6.3.2.2 Interface Configuration

1. Configuring authentication mode

The switch provides two authentication modes: username/password and VLAN ID.

Run the following command in interface configuration mode to configure the authentication mode:

Run...	To...
web-auth mode user <i>vlan-id</i>	Configure the authentication mode.

2. Configuring authentication method list

Different authentication method lists can be applied on each interface. By default, the authentication method

list named **default** is applied on each interface.

Run the following command in interface configuration mode to configure the authentication method list:

Run...	To...
web-auth authentication WORD	Configure the authentication method list.

3. Configuring the accounting method list

Different accounting method lists can be applied on each interface. By default, the accounting method list named **default** is applied on each interface.

Run the following command in interface configuration mode to configure the accounting method list:

Run...	To...
web-auth accounting WORD	Configure the accounting method list.

6.3.2.3 Enabling Web Authentication

If global configuration and interface configuration satisfy the requirements, you can enable the Web authentication on the designated routing switch.

Run the following command in interface configuration mode to enable the Web authentication:

Run...	To...
web-auth enable	Enable the Web authentication.

6.3.3 Monitoring and Maintaining Web Authentication

6.3.3.1 Checking the Global Configuration

Run the following command in privileged mode to check the global configuration:

Run...	To...
show web-auth	Check the global configuration.

6.3.3.2 Checking Interface Configuration

Run the following command in interface configuration mode to check the interface configuration:

Run...	To...
show web-auth interface [vlan SuperVlan]	Check the interface configuration.

6.3.3.3 Checking User State

Run the following command in privileged mode to check the user state:

Run...	To...
show web-auth user	Check the user state.

6.3.3.4 Mandatorily Kicking Out Users

Run the following command in global configuration mode to mandatorily kick out a user.

Run...	To...
web-auth kick-out user-IP	Mandatorily kick out a user.

6.3.4 Web Authentication Configuration Example

Network topology

See Figure 6-5:

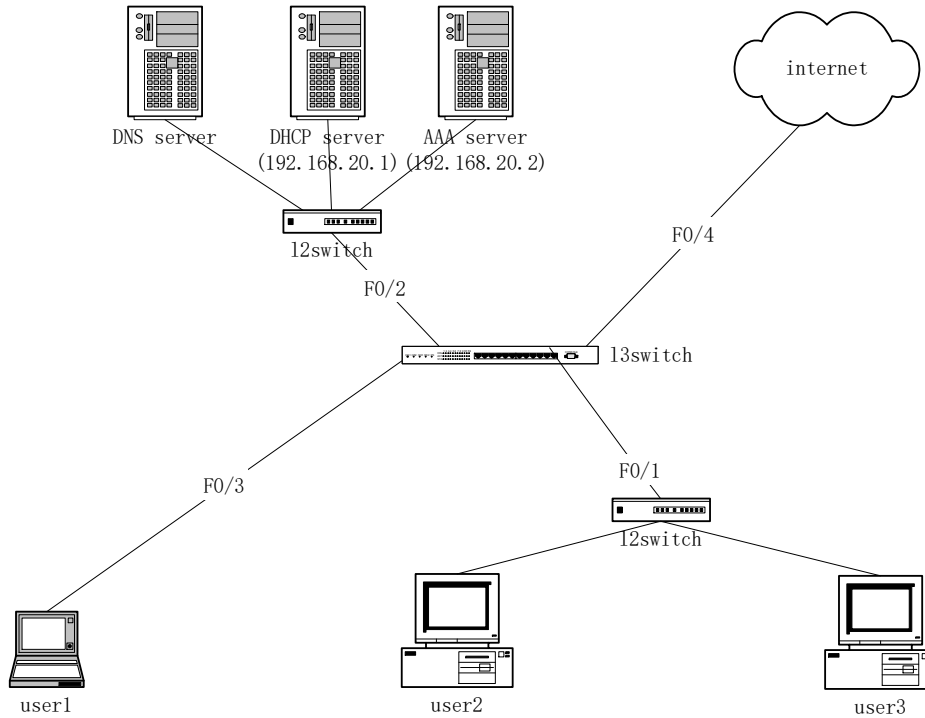

Figure 6-5 Network topology

Global configuration

```

aaa authentication login auth-weba radius
aaa accounting network acct-weba start-stop radius
!
radius-server host 192.168.20.2 auth-port 1812 acct-port 1813
radius-server key 405.10
!
ip dhcpd enable
ip http server
!
vlan 1-4
!
web-auth portal-server 192.168.20.41
web-auth holdtime 3600
web-auth authtime 600
web-auth keep-alive 180

```

Configuration of the layer-2 interface

```
interface FastEthernet0/1
  switchport pvid 1
!
interface FastEthernet0/2
  switchport pvid 2
!
interface FastEthernet0/3
  switchport pvid 3
!
interface FastEthernet0/4
  switchport pvid 4
```

Configuration of the routing interface

```
interface VLAN1
  no ip directed-broadcast
  ip helper-address 192.168.20.1
  web-auth accounting acct-weba
  web-auth authentication auth-weba
  web-auth mode vlan-id
  web-auth enable
!
interface VLAN2
  ip address 192.168.20.41 255.255.255.0
  no ip directed-broadcast
!
interface VLAN3
  no ip directed-broadcast
  ip helper-address 192.168.20.1
  web-auth accounting acct-weba
  web-auth authentication auth-weba
  web-auth mode user
  web-auth enable
!
interface VLAN4
  no ip directed-broadcast
!
```

Chapter 7. Web Configuration

7.1 HTTP Switch Configuration

7.1.1 HTTP Configuration

Switch configuration can be conducted not only through command lines and SNMP but also through Web browser. The switches support the HTTP configuration, the abnormal packet timeout configuration, and so on.

7.1.1.1 Choosing the Prompt Language

Up to now, switches support two languages, that is, English and Chinese, and the two languages can be switched over through the following command.

Command	Purpose
ip http language {chinese english}	Sets the prompt language of Web configuration to Chinese or English .

7.1.1.2 Setting the HTTP Port

Generally, the HTTP port is port 80 by default, and users can access a switch by entering the IP address directly; however, switches also support users to change the service port and after the service port is changed you have to use the IP address and the changed port to access switches. For example, if you set the IP address and the service port to **192.168.1.3** and **1234** respectively, the HTTP access address should be changed to **http: // 192.168.1.3: 1234**. You'd better not use other common protocols' ports so that access collision should not happen. Because the ports used by a lot of protocols are hard to remember, you'd better use port IDs following port 1024.

Command	Purpose
ip http port { portNumber }	Sets the HTTP port.

7.1.1.3 Enabling the HTTP Service

Switches support to control the HTTP access. Only when the HTTP service is enabled can HTTP exchange happen between switch and PC and, when the HTTP service is closed, HTTP exchange stops.

Command	Purpose
ip http server	Enables the HTTP service.
ip http {timeout}	Configures the timeout time of HTTP abnormal packets.

7.1.1.4 Setting the HTTP Access Mode

You can access a switch through two access modes: HTTP access and HTTPS access, and you can use the following command to set the access mode to **HTTP**.

Command	Purpose
ip http http-access enable	Sets the HTTP access mode.

7.1.1.5 Setting the Maximum Number of VLAN Entries on Web Page

A switch supports at most 4094 VLANs and in most cases Web only displays parts of VLANs, that is, those VLANs users want to see. You can use the following command to set the maximum number of VLANs. The default maximum number of VLANs is 100.

Command	Purpose
ip http web max-vlan { <i>max-vlan</i> }	Sets the maximum number of VLAN entries displayed in a web page.

7.1.1.6 Setting the Maximum Number of Multicast Entries Displayed on a Web Page

A switch supports at most 100 multicast entries. You can run the following command to set the maximum number of multicast entries and Web then shows these multicast entries. The default maximum number of multicast entries is 15.

Command	Purpose
ip http web igmp-groups { <i>igmp-groups</i> }	Sets the maximum number of multicast entries displayed in a web page.

7.1.2 HTTPS Configuration

In order to improve the security of communications, switches support not only the HTTP protocol but also the HTTPS protocol. HTTPS is a security-purposed HTTP channel and it is added to the SSL layer under HTTP.

7.1.2.1 Setting the HTTP Access Mode

You can run the following command to set the access mode to **HTTPS**.

Command	Purpose
ip http ssl-access enable	Sets the HTTPS access mode.

7.1.2.2 It is used to set the HTTPS port.

As the HTTP port, HTTPS has its default service port, port 443, and you also can run the following command to change its service port. It is recommended to use those ports following port 1024 so as to avoid collision with other protocols' ports.

Parameter	Remarks
ip http secure-port { <i>portNumber</i> }	Sets the HTTPS port.

7.2 Configuration Preparation

7.2.1 Accessing the Switch through HTTP

When accessing the switch through Web, please make sure that the applied browser complies with the following requirements:

- HTML of version 4.0
- HTTP of version 1.1
- JavaScript™ of version 1.5

What's more, please ensure that the main program file, running on a switch, supports Web access and your computer has already connected the network in which the switch is located.

7.2.1.1 Initially Accessing the Switch

When the switch is initially used, you can use the Web access without any extra settings:

1. Modify the IP address of the network adapter and subnet mask of your computer to **192.168.0.1** and **255.255.255.0** respectively.
2. Open the Web browser and enter **192.168.0.254** in the address bar. It is noted that **192.168.0.254** is the default management address of the switch.
3. If the Internet Explorer browser is used, you can see the dialog box in figure 1. Both the original username and the password are "admin", which is capital sensitive.



Figure 1: ID checkup of WEB login

4. After successful authentication, the systematic information about the switch will appear on the IE browser.

7.2.1.2 Upgrading to the Web-Supported Version

If your switch is upgraded to the Web-supported version during its operation and the switch has already stored its configuration files, the Web visit cannot be directly applied on the switch. Perform the following steps one by one to enable the Web visit on the switch:

1. Connect the console port of the switch with the accessory cable, or telnet to the management address of the switch through the computer.
2. Enter the global configuration mode of the switch through the command line, the DOS prompt of which is similar to "Switch_config#".
3. If the management address of the switch is not configured, please create the VLAN interface and configure the IP address.
4. Enter the **ip http server** command in global configuration mode and start the Web service.
5. Run **username** to set the username and password of the switch. For how to use this command, refer to the "Security Configuration" section in the user manual.
6. After the above-mentioned steps are performed, you can enter the address of the switch in the Web browser to access the switch.
7. Enter **write** to store the current configuration to the configuration file.

7.2.2 Accessing a Switch through Secure Links

The data between the WEB browser and the switch will not be encrypted if you access a switch through common HTTP. To encrypt these data, you can use the secure links, which are based on the secure sockets layer, to access the switch.

To do this, you should follow the following steps:

1. Connect the console port of the switch with the accessory cable, or telnet to the management address of the switch through the computer.
2. Enter the global configuration mode of the switch through the command line, the DOS prompt of which is similar to "Switch_config#".
3. If the management address of the switch is not configured, please create the VLAN interface and configure the IP address.
4. Enter the **ip http server** command in global configuration mode and start the Web service.
5. Run **username** to set the username and password of the switch. For how to use this command, refer to the "Security Configuration" section in the user manual.
6. Run **ip http ssl-access enable** to enable the secure link access of the switch.
7. Run **no ip http http-access enable** to forbid to access the switch through insecure links.
8. Enter **write** to store the current configuration to the configuration file.
9. Open the WEB browser on the PC that the switch connects, enter <https://192.168.0.254> on the address bar (**192.168.0.254** stands for the management IP address of the switch) and then press the **Enter** key. Then the switch can be accessed through the secure links.

7.2.3 Introduction of Web Interface

The Web homepage appears after login, as shown in figure 2:



Figure 2: Web homepage

The whole homepage consists of the top control bar, the navigation bar, the configuration area and the bottom control bar.

7.2.3.1 Top Control Bar



Figure 3: Top control bar

- Save All** Write the current settings to the configuration file of the device. It is equivalent to the execution of the **write** command.

The configuration that is made through Web will not be promptly written to the configuration file after validation. If you click "Save All", the unsaved configuration will be lost after rebooting.
- Logout** Exit from the current login state.

After you click "logout", you have to enter the username and the password again if you want to continue the Web function.
- About** Display company and website information.

After you configure the device, the result of the previous step will appear on the left side of the top control bar. If error occurs, please check your configuration and retry it later.

7.2.3.2 Navigation Bar



Figure 4 Navigation bar

The contents in the navigation bar are shown in a form of list and are classified according to types. By default, the list is located at “Runtime Info”. If a certain item need be configured, please click the group name and then the sub-item. For example, to browse the flux of the current port, you have to click “Interface State” and then “Interface Flow”.



The limited user can only browse the state of the device and cannot modify the configuration of the device. If you log on to the Web with limited user’s permissions, only “Interface State” will appear.

7.2.3.3 Configuration Area

System Information	
Device Type	XGS-6350-24X4C
BIOS Version	0.1.1
Firmware Version	2.2.0D Build 59731
Serial No.	A98005YM01012076
MAC Address	A8F7.E008.6C40
IP Address	192.168.0.254
Current Time	1970-1-1 0:15:43
Uptime	0 Day -0 Hour -15 Minute -6 Second
CPU Usage	2%
Memory Usage	18%

Figure 5 Configuration Area

The configuration display area shows the state and configuration of the device. The contents of this area can be modified by the clicking of the items in the navigation bar.

7.2.3.4 Bottom Control Bar

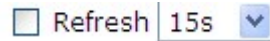

Figure 6: Bottom control bar

If you click the **About** button on the top control bar, the bottom control bar appears. The main function of the bottom control bar is to realize the automatic refreshing of the configuration display area. For example, if you click “Interface Flow” in the navigation bar and then click “Refresh”, the flow of the interface can be continuously monitored.

After you click “Refresh”, the countdown of the next-time refresh will appear on the left side. You can modify the countdown settings by clicking the dropdown list.



The smaller the countdown value is set, that is, the higher the frequency is, the higher the CPU usage is.

7.2.3.5 Configuration Area

The configuration area is to show the content that is selected in the navigation area. The configuration area always contains one or more buttons, and their functions are listed in the following table:

7.3 Basic Configuration

Device Status

Basic Config

Hostname
Clock Mgr.

Port Config

L2 Config

L3 Config

Advanced Config

Network Mgr.

Diagnostic Tool

System Mgr.

Figure 1 A list of basic configuration

7.3.1 Hostname Configuration

If you click **Basic Config -> Hostname Config** in the navigation bar, the **Hostname Configuration** page appears, as shown in figure 2.

Hostname Configuration

Configure the hostname.

	Hostname*	<input type="text" value="Switch"/>
		<input type="button" value="Apply"/> <input type="button" value="Reset"/>

Help

#Configure the hostname of the switch.

Figure 2 Hostname configuration

The hostname will be displayed in the login dialog box.

The default name of the device is “Switch”. You can enter the new hostname in the text box shown in figure 8 and then click “Apply”.

7.3.2 Time Management

If you click **System Manage -> Time Manage**, the **Time Setting** page appears.

Time Setting

System Time

Select Time-Zone	<input type="text" value="(GMT)Greenwich Mean Time,Dublin,London,Lisbon"/>											
<input checked="" type="radio"/> Set Time Manually												
Set Time	<input type="text" value="1970"/>	Year	<input type="text" value="01"/>	Month	<input type="text" value="08"/>	Day	<input type="text" value="21"/>	Hour	<input type="text" value="14"/>	Minute(s)	<input type="text" value="25"/>	Second
<input type="radio"/> Network Time Synchronization												
NTP Server One												
NTP Server Two												
NTP Server Three												

Figure 3 Clock management

To refresh the clock of the displayed device, click “Refresh”.

In the “Select Time-Zone” dropdown box select the time zone where the device is located. When you select “Set Time Manually”, you can set the time of the device manually. When you select “Network Time Synchronization”, you can designate 3 SNTP servers for the device and set the interval of time synchronization.

7.4 Configuration of the Physical Interface

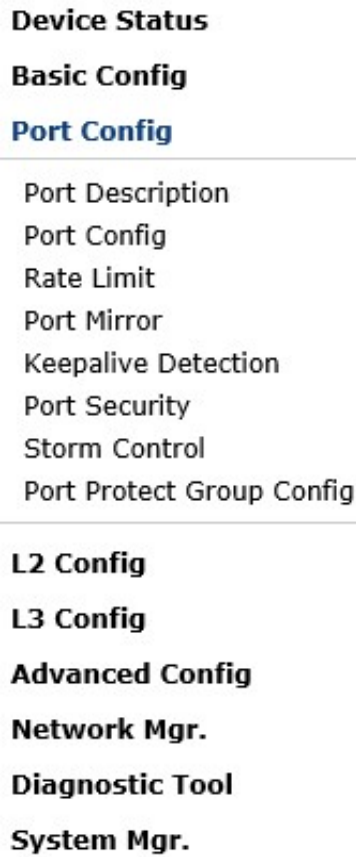

Figure 1: Physical port configuration list

7.4.1 Configuring Port Description

If you click **Physical port config -> Port description Config** in the navigation bar, the **Port description Configuration** page appears, as shown in figure 2.

Port	Port Description
tg0/1	
tg0/2	
tg0/3	
tg0/4	
tg0/5	
tg0/6	
tg0/7	
tg0/8	
tg0/9	
tg0/10	
tg0/11	
tg0/12	
tg0/13	
tg0/14	
tg0/15	
tg0/16	
tg0/17	
tg0/18	
tg0/19	
tg0/20	
tg0/21	
tg0/22	
tg0/23	
tg0/24	
cg0/1	
cg0/2	
cg0/3	
cg0/4	

Figure 2: Port description configuration

You can modify the port description on this page and enter up to 120 characters. The description of the VLAN port cannot be set at present.

7.4.2 Configuring the Attributes of the Port

If you click **Physical port config -> Port attribute Config** in the navigation bar, the **Port Attribute Configuration** page appears, as shown in figure 3.

Port	Status	Speed	Duplex	Flow Control	Medium
tg0/1	Enable ▼	1000M ▼	Full ▼	Off ▼	Auto ▼
tg0/2	Enable ▼	10G ▼	Full ▼	Off ▼	Auto ▼
tg0/3	Enable ▼	10G ▼	Full ▼	Off ▼	Auto ▼
tg0/4	Enable ▼	10G ▼	Full ▼	Off ▼	Auto ▼
tg0/5	Enable ▼	10G ▼	Full ▼	Off ▼	Auto ▼
tg0/6	Enable ▼	10G ▼	Full ▼	Off ▼	Auto ▼
tg0/7	Enable ▼	10G ▼	Full ▼	Off ▼	Auto ▼
tg0/8	Enable ▼	10G ▼	Full ▼	Off ▼	Auto ▼
tg0/9	Enable ▼	10G ▼	Full ▼	Off ▼	Auto ▼
tg0/10	Enable ▼	10G ▼	Full ▼	Off ▼	Auto ▼
tg0/11	Enable ▼	10G ▼	Full ▼	Off ▼	Auto ▼
tg0/12	Enable ▼	10G ▼	Full ▼	Off ▼	Auto ▼
tg0/13	Enable ▼	10G ▼	Full ▼	Off ▼	Auto ▼
tg0/14	Enable ▼	10G ▼	Full ▼	Off ▼	Auto ▼
tg0/15	Enable ▼	10G ▼	Full ▼	Off ▼	Auto ▼
tg0/16	Enable ▼	10G ▼	Full ▼	Off ▼	Auto ▼
tg0/17	Enable ▼	10G ▼	Full ▼	Off ▼	Auto ▼
tg0/18	Enable ▼	10G ▼	Full ▼	Off ▼	Auto ▼
tg0/19	Enable ▼	10G ▼	Full ▼	Off ▼	Auto ▼
tg0/20	Enable ▼	10G ▼	Full ▼	Off ▼	Auto ▼

Figure 3: Configuring the port attributes

On this page you can modify the on/off status, rate, duplex mode, flow control status and medium type of a port.



1. The Web page does not support the speed and duplex mode of the fast-Ethernet port.
2. After the speed or duplex mode of a port is modified, the link state of the port may be switched over and the network communication may be impaired.

7.4.3 Rate control

If you click **Physical port Config -> Port rate-limit Config** in the navigation bar, the **Port rate limit** page appears, as shown in figure 4.

Port	Receive Status	Receive Speed Unit	Receive Speed	Send Status	Send Speed Unit	Send Speed
tg0/1	Disable ▼	64kbps ▼	(1-156250)	Disable ▼	64kbps ▼	(1-156250)
tg0/2	Disable ▼	64kbps ▼	(1-156250)	Disable ▼	64kbps ▼	(1-156250)
tg0/3	Disable ▼	64kbps ▼	(1-156250)	Disable ▼	64kbps ▼	(1-156250)
tg0/4	Disable ▼	64kbps ▼	(1-156250)	Disable ▼	64kbps ▼	(1-156250)
tg0/5	Disable ▼	64kbps ▼	(1-156250)	Disable ▼	64kbps ▼	(1-156250)
tg0/6	Disable ▼	64kbps ▼	(1-156250)	Disable ▼	64kbps ▼	(1-156250)
tg0/7	Disable ▼	64kbps ▼	(1-156250)	Disable ▼	64kbps ▼	(1-156250)
tg0/8	Disable ▼	64kbps ▼	(1-156250)	Disable ▼	64kbps ▼	(1-156250)
tg0/9	Disable ▼	64kbps ▼	(1-156250)	Disable ▼	64kbps ▼	(1-156250)
tg0/10	Disable ▼	64kbps ▼	(1-156250)	Disable ▼	64kbps ▼	(1-156250)

Figure 4: Port's rate limit

On this page you can set the reception speed and transmission speed of a port. By default, all ports have no speed limited.

7.4.4 Port mirroring

If you click **Physical port Config -> Port Mirror** in the navigation bar, the **Port Mirror Config** page appears, as shown in figure 5.

Mirrored Port	Mirror Mode
<input type="checkbox"/> tg0/1	RX
<input checked="" type="checkbox"/> tg0/2	TX
<input type="checkbox"/> tg0/3	RX

Figure 5: Port mirror configuration

Click the drop-down list on the right side of "Mirror Port" and select a port to be the destination port of mirror. Click a checkbox and select a source port of mirror, that is, a mirrored port.

- RX The received packets will be mirrored to the destination port.
- TX The transmitted packets will be mirrored to a destination port.
- RX & TX The received and transmitted packets will be mirrored simultaneously.

7.4.5 Loopback Detection

If you click **Physical port Config -> Port loopback detection** in the navigation bar, the **Setting the port loopback detection** page appears, as shown in figure 6.

Port	Status	Keepalive Period
tg0/1	Enable	3333 (0-32767)Seconds
tg0/2	Disable	(0-32767)Seconds

Figure 6: Port loopback detection

You can set the loopback detection cycle on the Loopback Detection page.

7.4.6 Port security

7.4.6.1 IP Binding Configuration

If you click **Physical port Config -> Port Security -> IP bind** in the navigation bar, the **Configure the IP-Binding Info** page appears, as shown in figure 7.

Interface Name	Detail
tg0/1	Detail
tg0/2	Detail

Figure 7: IP binding configuration

Click "Detail" and then you can conduct the binding of the source IP address for each physical port. In this way, the IP address that is allowed to visit the port will be limited.

	Serial number	Address	Operate
<input type="checkbox"/>	1	192.168.0.2	Edit
<input type="checkbox"/>	2	192.168.0.3	Edit

Figure 8: Setting the binding of the source IP address

7.4.6.2 MAC Binding Configuration

If you click Physical port Config -> Port Security -> MAC bind in the navigation bar, the Configure the MAC-Binding Info page appears, as shown in figure 9.

Interface Name	tg0/1	Detail
		Detail

Figure 9: MAC binding configuration

Click “Detail” and then you can conduct the binding of the source MAC address for each physical port. In this way, the MAC address that is allowed to visit the port will be limited.

	Serial number	Address	Operate
<input type="checkbox"/>	1	1234.1234.1234	Edit
<input type="checkbox"/>	2	1234.1234.1235	Edit

Figure 10: Setting the binding of the source MAC address

7.4.6.3 Setting the Static MAC Filtration Mode

If you click Physical port Config -> Port Security -> Static MAC filtration mode in the navigation bar, the Configure the static MAC filtration mode page appears, as shown in figure 11.

Interface Name	Port Mode	Static MAC Filtration Mode
tg0/1	Access	Disable ▾

Figure 11: Setting the static MAC filtration mode

On this page you can set the static MAC filtration mode. By default, the static MAC filter is disabled. Also, the static MAC filter mode cannot be set on ports in trunk mode.

7.4.6.4 Static MAC Filtration Entries

If you click Physical port Config -> Port security -> Static MAC filtration entries in the navigation bar, the Setting the static MAC filtration entries page appears.

Interface Name	Detail
tg0/1	Detail

Figure 12: Static MAC filtration entry list

If you click “Detail”, you can conduct the binding of the source MAC address for each physical port. According to the configured static MAC filtration mode, the MAC address of a port can be limited, allowed or forbidden to visit.

	Serial number	Filtration Mode	MAC Address	Operate
<input type="checkbox"/>	1	Disable	0001.0002.0003	Edit

Figure 13: Setting static MAC filtration entries

7.4.6.5 Setting the Dynamic MAC Filtration Mode

If you click Physical port Config -> Port Security -> Dynamic MAC filtration mode in the navigation bar, the Configure the dynamic MAC filtration mode page appears, as shown in figure 14.

Interface Name	Dynamic MAC Filtration Mode	Max MAC Address
tg0/1	Disable ▾	1 (1-4095)

Figure 14: Setting the dynamic MAC filtration mode

You can set the dynamic MAC filtration mode and the allowable maximum number of addresses on this page. By default, the dynamic MAC filtration mode is disabled and the maximum number of addresses is 1.

7.4.7 Storm control

In the navigation bar, click **Physical port Config -> Storm control**. The system then enters the page, on which the broadcast/multicast/unknown unicast storm control can be set.

7.4.7.1 Broadcast Storm Control

Port	Status	Threshold
tg0/1	Disable ▼	(1-148809) 100PPS
tg0/2	Disable ▼	(1-148809) 100PPS
tg0/3	Disable ▼	(1-148809) 100PPS
tg0/4	Disable ▼	(1-148809) 100PPS
tg0/5	Disable ▼	(1-148809) 100PPS
tg0/6	Disable ▼	(1-148809) 100PPS
tg0/7	Disable ▼	(1-148809) 100PPS

Figure 15: Broadcast storm control

Through the drop-down boxes in the **Status** column, you can decide whether to enable broadcast storm control on a port. In the **Threshold** column you can enter the threshold of the broadcast packets. The legal threshold range for each port is given behind the threshold.

7.4.7.2 Multicast Storm Control

tg0/10	Disable ▼	(1-148809) 100PPS
tg0/11	Disable ▼	(1-148809) 100PPS
tg0/12	Disable ▼	(1-148809) 100PPS
tg0/13	Disable ▼	(1-148809) 100PPS
tg0/14	Disable ▼	(1-148809) 100PPS
tg0/15	Disable ▼	(1-148809) 100PPS
tg0/16	Disable ▼	(1-148809) 100PPS
tg0/17	Disable ▼	(1-148809) 100PPS
tg0/18	Disable ▼	(1-148809) 100PPS
tg0/19	Disable ▼	(1-148809) 100PPS
tg0/20	Disable ▼	(1-148809) 100PPS
tg0/21	Disable ▼	(1-148809) 100PPS
tg0/22	Disable ▼	(1-148809) 100PPS
tg0/23	Disable ▼	(1-148809) 100PPS
tg0/24	Disable ▼	(1-148809) 100PPS
cg0/1	Disable ▼	(1-1488095) 100PPS
cg0/2	Disable ▼	(1-1488095) 100PPS
cg0/3	Disable ▼	(1-1488095) 100PPS
cg0/4	Disable ▼	(1-1488095) 100PPS

Figure 16: Setting the broadcast storm control

Through the drop-down boxes in the **Status** column, you can decide whether to enable multicast storm control on a port. In the **Threshold** column you can enter the threshold of the multicast packets. The legal threshold range for each port is given behind the threshold.

7.4.7.3 Unknown Unicast Storm Control

tg0/10	Disable ▼		(1-148809) 100PPS
tg0/11	Disable ▼		(1-148809) 100PPS
tg0/12	Disable ▼		(1-148809) 100PPS
tg0/13	Disable ▼		(1-148809) 100PPS
tg0/14	Disable ▼		(1-148809) 100PPS
tg0/15	Disable ▼		(1-148809) 100PPS
tg0/16	Disable ▼		(1-148809) 100PPS
tg0/17	Disable ▼		(1-148809) 100PPS
tg0/18	Disable ▼		(1-148809) 100PPS
tg0/19	Disable ▼		(1-148809) 100PPS
tg0/20	Disable ▼		(1-148809) 100PPS
tg0/21	Disable ▼		(1-148809) 100PPS
tg0/22	Disable ▼		(1-148809) 100PPS
tg0/23	Disable ▼		(1-148809) 100PPS
tg0/24	Disable ▼		(1-148809) 100PPS
cg0/1	Disable ▼		(1-1488095) 100PPS
cg0/2	Disable ▼		(1-1488095) 100PPS
cg0/3	Disable ▼		(1-1488095) 100PPS
cg0/4	Disable ▼		(1-1488095) 100PPS

Figure 17: Unknown unicast storm control

In the **Threshold** column you can enter the threshold of the broadcast packets. The legal threshold range for each port is given behind the threshold.

7.5 Layer 2 Configuration



Figure 1: Layer-2 configuration list

7.5.1 VLAN Settings

7.5.1.1 VLAN List

If you click **Layer 2 Config** -> **VLAN Config** in the navigation bar, the **VLAN Config** page appears, as shown in figure 2.

	VLAN ID	VLAN Name	Operate
<input type="checkbox"/>	1	Default	Edit

Figure 2: VLAN configuration

The VLAN list will display VLAN items that exist in the current device according to the ascending order. In case of lots of items, you can look for the to-be-configured VLAN through the buttons like “Prev”, “Next” and “Search”.

You can click “New” to create a new VLAN.

You can also click “Edit” at the end of a VLAN item to modify the VLAN name and the port’s attributes in the

VLAN.

If you select the checkbox before a VLAN and then click “Delete”, the selected VLAN will be deleted.

By default, a VLAN list can display up to 100 VLAN items. If you want to configure more VLANs through Web, please log on to the switch through the Console port or Telnet, enter the global configuration mode and then run the “**ip http web max-vlan**” command to modify the maximum number of VLANs that will be displayed.



7.5.1.2 VLAN Settings

If you click "New" or “Edit” in the VLAN list, the VLAN configuration page appears, on which new VLANs can be created or the attributes of an existent VLAN can be modified.

VLAN ID		2		
VLAN Name		VLAN0002		
Port	Default VLAN	Mode	Untag or not	Allow or not
tg0/1	1 <1-4094>	Access ▾	No ▾	Yes ▾
tg0/2	1 <1-4094>	Access ▾	No ▾	Yes ▾
tg0/3	1 <1-4094>	Access ▾	No ▾	Yes ▾
tg0/4	1 <1-4094>	Access ▾	No ▾	Yes ▾
tg0/5	1 <1-4094>	Access ▾	No ▾	Yes ▾
tg0/6	1 <1-4094>	Access ▾	No ▾	Yes ▾
tg0/7	1 <1-4094>	Access ▾	No ▾	Yes ▾
tg0/8	1 <1-4094>	Access ▾	No ▾	Yes ▾
tg0/9	1 <1-4094>	Access ▾	No ▾	Yes ▾
tg0/10	1 <1-4094>	Access ▾	No ▾	Yes ▾
tg0/11	1 <1-4094>	Access ▾	No ▾	Yes ▾
tg0/12	1 <1-4094>	Access ▾	No ▾	Yes ▾
tg0/13	1 <1-4094>	Access ▾	No ▾	Yes ▾
tg0/14	1 <1-4094>	Access ▾	No ▾	Yes ▾
tg0/15	1 <1-4094>	Access ▾	No ▾	Yes ▾
tg0/16	1 <1-4094>	Access ▾	No ▾	Yes ▾
tg0/17	1 <1-4094>	Access ▾	No ▾	Yes ▾
tg0/18	1 <1-4094>	Access ▾	No ▾	Yes ▾
tg0/19	1 <1-4094>	Access ▾	No ▾	Yes ▾
tg0/20	1 <1-4094>	Access ▾	No ▾	Yes ▾
tg0/21	1 <1-4094>	Access ▾	No ▾	Yes ▾
tg0/22	1 <1-4094>	Access ▾	No ▾	Yes ▾
tg0/23	1 <1-4094>	Access ▾	No ▾	Yes ▾

Figure 3: Revising VLAN configuration

If you want to create a new VLAN, enter a VLAN ID and a VLAN name; the VLAN name can be null.

Through the port list, you can set for each port the default VLAN , the VLAN mode (Trunk or Access), whether to allow the entrance of current VLAN packets and whether to execute the untagging of the current VLAN when the port works as the egress port.



When a port in Trunk mode serves as an egress port, it will untag the default VLAN by default.

7.5.2 PDP Configuration

7.5.2.1 Configuring the Global Attributes of PDP

If you click **Layer 2 Config -> PDP Config** in the navigation bar, the **Global PDP Config** page appears, as shown in figure 4.

Basic Config of PDP Protocol	
Protocol State	Close the PDP protocol ▾
HoldTime Settings	180 (10-255)s
Setting the packet transmission cycle	60 (5-254)s
Protocol Version	Version2 ▾

Help

#HoldTime:If the other PDP packets are not received, the switch will save the holdtime before clearing the received packets.Its default value is 180s.
#Cycle of Sending Packets:Its default value is 60s.

Figure 4: Configuring the global attributes of PDP

You can choose to enable PDP or disable it. When you choose to disable PDP, you cannot configure PDP. The “HoldTime” parameter means the time to be saved before the router discards the received information if other PDP packets are not received. The protocol version cannot be read currently through the command line “show run”, so the protocol version is not handled on the Web.

7.5.2.2 Configuring the Attributes of the PDP Port

If you click Layer 2 Config -> PDPCongig-> PDP port Config in the navigation bar, the Setting the attributes of the PDP port page appears, as shown in figure 5.

Port	Status
tg0/1	Enable PDP ▾

Figure 5: PDP port configuration

After the PDP port is configured, you can enable or disable PDP on this port.

7.5.3 LDP Configuration

7.5.3.1 Configuring the Global Attributes of LLDP

If you click Layer 2 Config -> LLDP Config in the navigation bar, the Global LLDP Config page appears, as shown in figure 6.

Basic Config of LLDP Protocol	
Protocol State	Close the LLDP protocol ▾
HoldTime Settings	120 (0-65535)s
Reinit Settings	2 (2-5)s
Setting the packet transmission cycle	30 (5-65534)s

Help

#HoldTime:Means the TTL(Time to live) of sending LLDP packets. Its default value is 120s.
#Reinit:Means the delay of continuously sending LLDP packets. Its default value is 2s.

Figure 6: Configuring the global attributes of LLDP

You can choose to enable LLDP or disable it. When you choose to disable LLDP, you cannot configure LLDP.

The “HoldTime” parameter means the ttl value of the packet that is transmitted by LLDP, whose default value is 120s.

The “Reinit” parameter means the delay of successive packet transmission of LLDP, whose default value is 2s.

7.5.3.2 Configuring the Attributes of the LLDP Port

If you click Layer 2 Config -> LLDPConfig-> LLDP port Config in the navigation bar, the Setting the attributes of the LLDP port page appears, as shown in figure 7.

Port	Receive LLDP Packet	Send LLDP Packet
tg0/1	Disable ▾	Disable ▾
tg0/2	Disable ▾	Disable ▾
tg0/3	Disable ▾	Disable ▾
tg0/4	Disable ▾	Disable ▾

Figure 7: Configuring the LLDP port

After the LLDP port is configured, you can enable or disable LLDP on this port.

7.5.4 Link Aggregation Configuration

If you click Layer 2 Config ->Port Channel in the navigation bar, the Port aggregation Config page appears, as shown in figure 8.

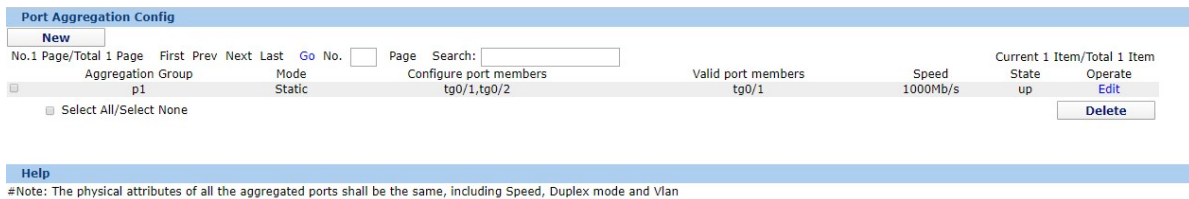

The screenshot shows the 'Port Aggregation Config' interface. At the top, there is a 'New' button and navigation controls. Below is a table with the following data:

No.	Page/Total	1 Page	First	Prev	Next	Last	Go	No.	Page	Search:
1	1	1								

Aggregation Group	Mode	Configure port members	Valid port members	Speed	Current State	Item/Total	Operate
p1	Static	tg0/1,tg0/2	tg0/1	1000Mb/s	up	1/1	Edit

Below the table, there is a 'Delete' button and a note: '#Note: The physical attributes of all the aggregated ports shall be the same, including Speed, Duplex mode and Vlan'.

Figure 8: Port aggregation configuration

If you click **New**, an aggregation group can be created. Up to 32 aggregation groups can be configured through Web and up to 8 physical ports in each group can be aggregated. If you click **Cancel**, you can delete a selected aggregation group; if you click **Modify**, you can modify the member port and the aggregation mode.

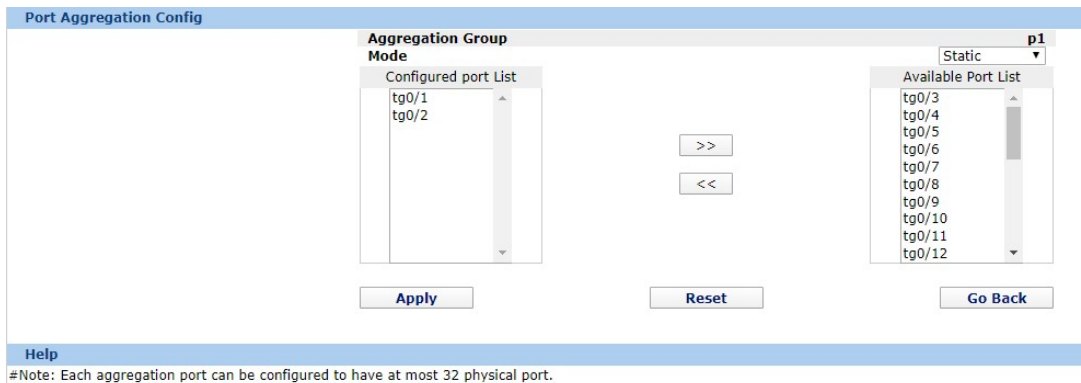

The screenshot shows the 'Port Aggregation Config' page in 'Modify' mode. The 'Aggregation Group' section has the following configuration:

- Mode:** Static
- Configured port List:** tg0/1, tg0/2
- Available Port List:** tg0/3, tg0/4, tg0/5, tg0/6, tg0/7, tg0/8, tg0/9, tg0/10, tg0/11, tg0/12

Buttons for 'Apply', 'Reset', and 'Go Back' are located at the bottom of the configuration area. A note at the bottom states: '#Note: Each aggregation port can be configured to have at most 32 physical port.'

Figure 9: Setting the member port of the aggregation group

An aggregation group is selectable when it is created but is not selectable when it is modified.

When a member port exists on the aggregation group, you can choose the aggregation mode to be **static**, **LACP active** or **LACP passive**.

You can click “>>” and “<<” to delete and add a member port in the aggregation group.

7.5.5 STP Configuration

7.5.5.1 STP Status Information

If you click **Layer 2 Config -> STP Config** in the navigation bar, the **STP Config** page appears, as shown in figure 10.

The screenshot shows the STP Configuration page with three main sections:

- Root STP Config:** A table with fields: Spanning Tree Priority (32768), MAC Address, Hello Time (2), Max Age (20), and Forward Delay (15).
- Local STP Config:** A form with fields: Protocol Type (RSTP), Spanning Tree Priority (32768), MAC Address, Hello Time (2 (1-10)s), Max Age (20 (6-40)s), Forward Delay (15 (4-30)s), and BDPDU Terminal (Disable). There are 'Apply' and 'Reset' buttons at the bottom.
- STP Port's State:** A table with columns: Interface, Role, State, Cost, Priority, Port ID, and Type. It includes a search bar and pagination controls.

Figure 10: Configuring the global attributes of STP

The root STP configuration information and the STP port's status are only-read.

On the local STP configuration page, you can modify the running STP mode by clicking the Protocol type drop-down box. The STP modes include STP, RSTP and disabled STP.

The priority and the time need to be configured for different modes.



The change of the STP mode may lead to the interruption of the network.

7.5.5.2 Configuring the Attributes of the STP Port

If you click the "Configure RSTP Port" option, the "Configure RSTP Port" page appears.

Port	Protocol Status	Priority(0~240)	Path-Cost(0~200000000)	Edge Port	RSTP Ring
tg0/1	Enable	128	0	Disable	Disable
tg0/2	Enable	128	0	Disable	Disable
tg0/3	Enable	128	0	Disable	Disable
tg0/4	Enable	128	0	Disable	Disable
tg0/5	Enable	128	0	Disable	Disable
tg0/6	Enable	128	0	Disable	Disable
tg0/7	Enable	128	0	Disable	Disable
tg0/8	Enable	128	0	Disable	Disable

Figure 11: Configuring the attributes of RSTP

The configuration of the attributes of the port is irrelative of the global STP mode. For example, if the protocol status is set to “Disable” and the STP mode is also changed, the port will not run the protocol in the new mode.

The default value of the path cost of the port is 0, meaning the path cost is automatically calculated according to the speed of the port. If you want to change the path cost, please enter another value.

7.5.6 GMP Snooping Configuration

7.5.6.1 IGMP Snooping Configuration

If you click **Layer 2 Config -> IGMP snooping**, the IGMP snooping configuration page appears.

IGMP Snooping Config	
Multicast Filtration Mode	Transfer Unknown ▾
IGMP Snooping	Enable ▾
Enable Auto Query	Enable ▾

Apply

Figure 12: IGMP-snooping configuration

On this page you can set whether to make a switch to forward unknown multicasts, whether to enable IGMP snooping, and whether to configure the switch as the querier of IGMP.

7.5.6.2 IGMP Snooping VLAN List

If you click **Layer 2 Config -> IGMP snooping VLAN list**, the IGMP snooping VLAN list page appears.

	VLAN ID	Status of the IGMP Snooping Vlan	Immediate-leave	Multicast Router's Port	Operate
<input type="checkbox"/>	1	Running	Disable	SWITCH(querier);	Edit

Figure 13: IGMP-snooping VLAN list

If you click **New**, IGMP snooping VLAN configuration can be done. Through Web up to 8 physical ports can be set on each IGMP snooping VLAN. If you click **Cancel**, a selected IGMP snooping VLAN can be deleted; if you click **Edit**, you can modify the member port, running status and immediate-leave of IGMP snooping VLAN.

Figure 14: Static routing port of IGMP VLAN

When an IGMP snooping VLAN is created, its VLAN ID can be modified; but when the IGMP snooping VLAN is modified, its VLAN ID cannot be modified.

You can click “>>” and “<<” to delete and add a routing port.

7.5.6.3 Static Multicast Address

If you click Static multicast address, the Setting the static multicast address page appears.

Figure 15: Multicast List

On this page, the currently existing static multicast groups and port groups in each static multicast group are shown.

Click “Refresh” to refresh the contents in the list.

7.5.6.4 Multicast List

Click the **Multicast List Info** option on the top of the page and the **Multicast List Info** page appears.

Figure 16: Multicast List

On this page the multicat groups, which exist in the current network and are in the statistics of IGMP snooping, as well as port sets on which members in each group are belong to are displayed.

Click “Refresh” to refresh the contents in the list.



By default, a multicast list can display up to 15 VLAN items. You can modify the number of multicast items by running **ip http web igmp-groups** after you log on to the device through the Console port or Telnet.

7.5.7 Setting Static ARP

If you click **Layer 2 Config -> Static ARP Config**, the static ARP configuration page appears.

Figure 17: Displaying static ARP

You can click New to add an ARP entry. If the Alias column is selected, it means to answer the ARP request of the designated IP address.

If you click Edit, you can modify the current ARP entry.

If you click Cancel, you can cancel the chosen ARP entry.

Figure 18 Setting static ARP

7.5.8 Ring Protection Configuration

7.5.8.1 EAPS Ring List

If you click Layer 2 Config -> Ring protection Config, the EAPS ring list page appears.

Ring ID	Node Type	Ring Description	Control VLAN	Status	Hello	Fail	Preforward	Primary Port/Forwarding/Link Status	Secondary Port/Forwarding/Link Status
<input type="checkbox"/> Select All/Select None <input type="button" value="Delete"/> <input type="button" value="Refresh"/> 									

Figure 19: EAPS Ring List

In the list shows the currently configured EAPS ring, including the status of the ring, the forwarding status of the port and the status of the link.

Click “New” to create a new EAPS ring.

Click the “Operate” option to configure the “Time” parameter of the ring.



1. The system can support 8 EAPS rings.
2. After a ring is configured, its port, node type and control VLAN cannot be modified. If the port of the ring, the node type or the control VLAN needs to be adjusted, please delete the ring and then establish a new one.

7.5.8.2 EAPS Ring Configuration

If you click “New” on the EAPS ring list, or “Operate” on the right side of a ring item, the “Configure EAPS” page appears.

ether-ring

Ring ID	0	
Node Type	Master Node	
Ring Description		
Control VLAN		
Hello Time	1	(1-10)s
Fail Time	3	(3-30)s
Preforward Time	3	(3-30)s
Primary Port	None	
Secondary Port	None	

Help

#Ring Description: You can't input 'Enter'.

Figure 20: EAPS ring configuration



If you want to modify a ring, on this page the node type, the control VLAN, the primary port and the secondary port cannot be modified.

In the dropdown box on the right of “Ring ID”, select an ID as a ring ID. The ring IDs of all devices on the same ring must be the same.

The dropdown box on the right of “Node Type” is used to select the type of the node. Please note that only one master node can be configured on a ring.

Enter a value between 1 and 4094 in the text box on the right of “Control VLAN” as the control VLAN ID. When a ring is established, the control VLAN will be automatically established too. Please note that if the designated control VLAN is 1 and the VLAN of the control device is also 1 the control device cannot access the control VLAN. Additionally, please do not enter a control VLAN ID that is same as that of another ring. In the text boxes of “Primary Port” and “Secondary Port”, select a port as the ring port respectively. If "Node Type" is selected as “Transit-Node”, the two ports will be automatically set to transit ports. Click “Apply” to finish EAPS ring configuration, click “Reset” to resume the initial values of the configuration, or click “Return” to go back to the EAPS list page.

7.5.9 DDM Configuration

If you click **L2 Config -> DDM Config** in the navigation bar, the **DDM configuration** page appears, as shown in figure 21.



Figure 21: DDM configuration

7.6 Layer 3 Configuration

- Device Status**
- Basic Config**
- Port Config**
- L2 Config**
- L3 Config**
 - VLAN Interfaces and IP Addresses
 - Static Route
 - OSPF Route Config
 - IGMP Proxy
- Advanced Config**
- Network Mgr.**
- Diagnostic Tool**
- System Mgr.**

Figure 1: Layer-3 configuration list



Only layer-3 switches have the layer-3 configuration.

7.6.1 Configuring the VLAN Interface

If you click Layer 3 Config -> VLAN interface Config, the Configuring the VLAN interface page appears.

Name of the VLAN Interface	IP Attribute	IP Address	Operate
1	Manual Config	192.168.0.254/24;	Edit

Select All/Select None [Delete](#)

Figure 2: Configuring the VLAN interface

Click New to add a new VLAN interface. Click Cancel to delete a VLAN interface. Click Modify to modify the settings of a corresponding VLAN interface.

When you click New, the name of the corresponding VLAN interface can be modified; but if you click Modify, the name of the corresponding VLAN interface cannot be modified.

VLAN Interface Config

IP Attribute

VLAN Interface Name*	1
IP Attribute*	Manual Config

Primary IP Address

IP Address*	192.168.0.254
MASK address*	255.255.255.0

Secondary IP Address 1

IP Address*	
MASK address*	

Secondary IP Address 2

IP Address*	
MASK address*	

[Apply](#)
[Reset](#)
[Go Back](#)

Help

The primary IP must be configured for the VLAN interface before the secondary IP is configured

Figure 3: VLAN interface configuration



Before the accessory IP of a VLAN interface is set, you have to set the main IP.

7.6.2 Setting the Static Route

If you click Layer 3 Config -> Static route Config, the Static route configuration page appears.

Static Routing Protocol Config

[New](#)

No.0 Page/Total 0 Page First Prev Next Last Go No. Page Search: Current 0 Item/Total 0 Item

Default Route	Dest IP Segment	Dest IP Mask	Interface Type	VLAN Interface	Gateway's IP Address	Forwarding Routing Address	Distance metric	Routing Tag	Global	Specify the route description	Operate
<input type="checkbox"/> Select All/Select None Delete											

Help

#Global: The next-hop address is in the global routing table.

Figure 4: Displaying the static route

Click Create to add a static route.

If you click Edit, you can modify the current static route.

If you click Cancel, you can cancel the chosen static route.

Figure 5: Setting the static route

7.6.3 IGMP Proxy

7.6.3.1 Enabling the IGMP Proxy

If you click Layer-3 Config -> IGMP proxy, the IGMP proxy page appears.

Figure 6: Enabling the IGMP agent

On this page you can enable or disable the IGMP proxy. It is noted that the IGMP proxy can be enabled or disabled on a switch only after the IP IGMP-snooping function is enabled on the switch.

7.6.3.2 Setting the IGMP Proxy

If you click Layer-3 Config -> IGMP proxy-> IGMPproxy Config, the IGMP proxy configuration page appears.

Click New to create a new IGMP agent.

Figure 7: Setting the IGMP agent

7.7 Advanced Configuration



Figure 1: A list of advanced configuration

7.7.1 QoS Configuration

7.7.1.1 Configuring QoS Port

If you click Advanced Config -> QoS -> Configure QoS Port, the Port Priority Config page appears.

Port	COS value
tg0/1	▼
tg0/2	▼
tg0/3	▼
tg0/4	▼
tg0/5	▼
tg0/6	▼
tg0/7	▼
tg0/8	0
tg0/9	1
tg0/10	2
tg0/11	3
tg0/12	4
tg0/13	5
tg0/14	6
tg0/15	7

Figure 2: Configuring the QoS Port

You can set the CoS value by clicking the dropdown box on the right of each port and selecting a value. The default CoS value of a port is 0, meaning the lowest priority. If the CoS value is 7, it means that the priority is

the highest.

7.7.1.2 Global QoS Configuration

If you click Advanced Config -> QoS Config -> Global QoS Config, the Port's QoS parameter configuration page appears.

Figure 3: Configuring global QoS attributes

In WRR schedule mode, you can set the weights of the QoS queues. There are 4 queues, among which queue 1 has the lowest priority and queue 4 has the highest priority.

7.7.2 MAC Access Control List

7.7.2.1 Setting the Name of the MAC Access Control List

If you click Advanced Config -> MAC access control list -> MAC access control list Config, the MAC ACL configuration page appears.

Figure 4: MAC access control list configuration

Click New to add a name of the MAC access control list. Click Cancel to delete a MAC access control list.

Figure 5: Setting the name of MAC access control list

7.7.2.2 Setting the Rules of the MAC Access Control List

If you click **Modify**, the corresponding MAC access control list appears and you can set the corresponding rules for the MAC access control list.

No.	Authority	Src MAC Type	Src MAC	Src MAC Mask	Dst MAC Type	Dst MAC	Dst MAC Mask	Operate
1	permit	host	0001.0002.0003		any			Edit

Figure 6: Specific MAC access control list configuration

Click **New** to add a rule of the MAC access control list. Click **Cancel** to delete a rule of the MAC access control list.

Modify MAC ACL Regulation

Modify MAC ACL host item

Authority: permit

Src MAC Type*: host

Src MAC*: 0001.0002.0003

Src MAC Mask*:

Dst MAC Type*: any

Dst MAC*:

Dst MAC Mask*:

Buttons: Apply, Reset, Go Back

Help: #MAC: the valid mac address can be one of the following formats: XXXXXXXXXXXX, XXXX.XXXX.XXXX, XX:XX:XX:XX:XX:XX, and XX-XX-XX-XX-XX-XX, among which X is a Hex number

Figure 7: Setting the Rules of the MAC Access Control List

7.7.2.3 Applying the MAC Access Control List

If you click Advanced Config -> MAC access control list -> Applying the MAC access control list, the Applying the MAC access control list page appears.

Port	Egress ACL	Ingress ACL
tg0/1		
tg0/2		
tg0/3		
tg0/4		
tg0/5		
tg0/6		
tg0/7		

Figure 8: Applying the MAC access control list

7.7.3 IP Access Control List

7.7.3.1 Setting the Name of the IP Access Control List

If you click Advanced Config -> IP access control list -> IP access control list Config, the IP ACL configuration page appears.

No.	Name of the IP ACL	Attribute of the IP ACL	Operate
1	ada	extended	Edit
2	myad	standard	Edit

Figure 9: IP access control list configuration

Click **New** to add a name of the IP access control list. Click **Cancel** to delete an IP access control list.

Figure 10: Creating a name of the IP access control list

If you click **Modify**, the corresponding IP access control list appears and you can set the corresponding rules for the IP access control list.

7.7.3.2 Setting the Rules of the IP Access Control List

➤ Standard IP access control list

No.	Authority	Src IP	Src IP Mask	Record the log	Operate
1	permit	1.1.1.1	255.255.255.0	log	Edit

Figure 11: Standard IP access control list

Click **New** to add a rule of the IP access control list. Click **Cancel** to delete a rule of the IP access control list. If you click **Modify**, the corresponding IP access control list appears and you can set the corresponding rules for the IP access control list.

Figure 12: Setting the Rules of the standard IP access control list

➤ Extended IP access control list

Authority	Mask Type	Protocol Number	Src Address	Src Port	Dst Address	Dst Port	Time-Range	TosPrecedence	Do not fragment the flag	Fragmented Packet	Offset	Length of the IP packet	Time-to-live Value	Record the log	Operate
permit	Mask	0	1.1.1.1/255.255.255.0		any		10							log	Edit

Figure 13: Extended IP access control list

Click **New** to add a rule of the IP access control list. Click **Cancel** to delete a rule of the IP access control list. If you click **Modify**, the corresponding IP access control list appears and you can set the corresponding rules

for the IP access control list.

Authority	permit	▼
Mask Type	Mask	▼
Protocol Number*	0	
Src IP Type	Specify IP	▼
Src IP*	1.1.1.1	
Src IP Mask*	255.255.255.0	
Src Interface Vlan*		
Src IP Range*		-
Src Port		
Src Port Range		-
Dst IP Type	any	▼
Dst IP*		
Dst IP Mask*		
Dst Interface Vlan*		
Dst IP Range*		-
Dst Port		
Dst Port Range		-
Time-Range	10	
Tos		
Precedence		
Do not fragment		▼
Fragmented Packet		▼
Offset		▼
Length of the IP Packet		▼
Time-to-live Value		▼
Log	<input checked="" type="checkbox"/>	
Location	1	

Figure 14: Setting the Rules of the extended IP access control list

7.7.3.3 Applying the IP Access Control List

If you click Advanced Config -> IP access control list -> Applying the IP access control list, the Applying the IP access control list page appears.

Port	Egress ACL	Ingress ACL
tg0/1	myacl	
tg0/2		acla
tg0/3		
tg0/4		
tg0/5		
tg0/6		
tg0/7		
tg0/8		

Figure 15: Applying the IP access control list

7.8 Network Management Configuration

- Device Status
- Basic Config
- Port Config
- L2 Config
- L3 Config
- Advanced Config
- Network Mgr.**

- SNMP Mgr.
- RMON Config

- Diagnostic Tool
- System Mgr.

Figure 1: Network management configuration list

7.8.1 SNMP Configuration

If you click **Network management Config -> SNMP management** in the navigation bar, the **SNMP management** page appears, as shown in figure 2.

7.8.1.1 SNMP Community Management

The screenshot shows the 'SNMP Community Management' interface. At the top, there is a 'New' button. Below it, a navigation bar includes 'No.1 Page/Total 1 Page', 'First', 'Prev', 'Next', 'Last', 'Go', 'No.', a search box, and 'Page'. On the right, it says 'Current 1 Item/Total 1 Item'. The main content is a table with the following data:

SNMP Community Name	SNMP Community Encryption	SNMP Community Attribute	Operate
public	False	RO	Edit

Below the table, there is a checkbox for 'Select All/Select None' and a 'Delete' button.

Figure 2: SNMP community management

On the SNMP community management page, you can know the related configuration information about SNMP community.

You can create, modify or cancel the SNMP community information, and if you click **New** or **Edit**, you can switch to the configuration page of SNMP community.

The screenshot shows the 'SNMP Community Management' settings page. It features two input fields:

- SNMP Community Name:** A text input field containing 'public' with a note 'Input less than 20 characters'.
- SNMP Community Attribute:** A dropdown menu currently set to 'Read Only'.

At the bottom, there are two buttons: 'Apply' and 'Go Back'.

Figure 3: SNMP community management settings

On the SNMP community management page you can enter the SNMP community name, select the attributes

of SNMP community, which include Read only and Read-Write.

7.8.1.2 SNMP Host Management

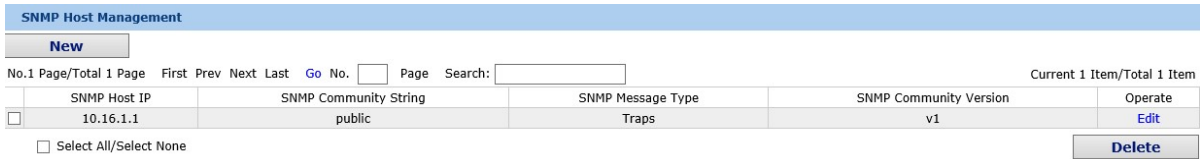

The screenshot shows a table titled "SNMP Host Management" with a "New" button. Below the table is a search bar and a "Select All/Select None" checkbox. The table has the following columns: "SNMP Host IP", "SNMP Community String", "SNMP Message Type", "SNMP Community Version", and "Operate".

SNMP Host IP	SNMP Community String	SNMP Message Type	SNMP Community Version	Operate
10.16.1.1	public	Traps	v1	Edit

Figure 4: SNMP host management

On the SNMP community host page, you can know the related configuration information about SNMP host. You can create, modify or cancel the SNMP host information, and if you click **New** or **Edit**, you can switch to the configuration page of SNMP host.



The screenshot shows the configuration form for an SNMP host. It includes fields for "SNMP Host IP", "SNMP Community", "SNMP Message Type" (set to "Traps"), and "SNMP Community Version" (set to "v1"). A note states: "* Informs is not supported in version v1". There are "Apply" and "Go Back" buttons at the bottom.

Figure 5: SNMP host management settings

On the SNMP host configuration page, you can enter **SNMP Host IP**, **SNMP Community**, **SNMP Message Type** and **SNMP Community Version**. **SNMP Message Type** includes **Traps** and **Informs**, and as to version 1, **SNMP Message Type** does not support **Informs**.

7.8.2 RMON

7.8.2.1 RMON Statistic Information Configuration

If you click Network Management Config -> RMON -> RMON Statistics -> New, the RMON Statistics page appears.

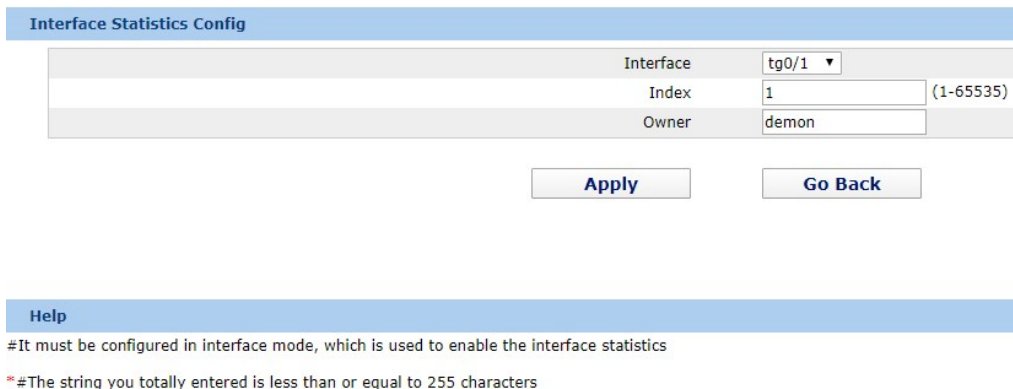

The screenshot shows the "Interface Statistics Config" form. It has fields for "Interface" (set to "tg0/1"), "Index" (set to "1"), and "Owner" (set to "demon"). There are "Apply" and "Go Back" buttons. Below the form is a "Help" section with the following text:

#It must be configured in interface mode, which is used to enable the interface statistics
 *#The string you totally entered is less than or equal to 255 characters

Figure 6: Configuring the RMON statistic information

You need to set a physical port to be the reception terminal of the monitor data.

The index is used to identify a specific interface; if the index is same to that of the previous application

interface, it will replace that of the previous application interface.

At present, the monitor statistic information can be obtained through the command line “show rmon statistics”, but the Web does not support this function.

7.8.2.2 RMON History Information Configuration

If you click Network Management Config -> RMON -> RMON history -> New, the RMON history page appears.

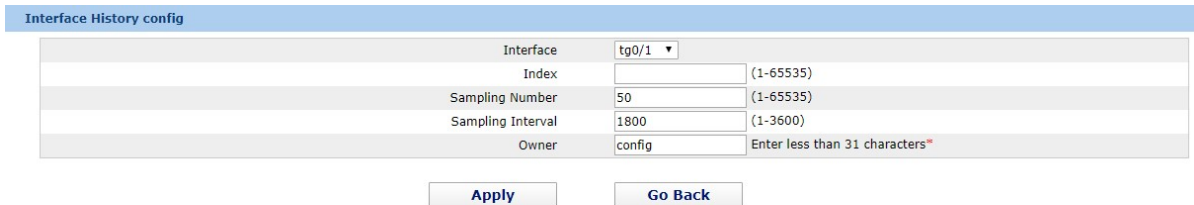

Interface History config		
Interface	tg0/1	
Index		(1-65535)
Sampling Number	50	(1-65535)
Sampling Interval	1800	(1-3600)
Owner	config	Enter less than 31 characters*
<input type="button" value="Apply"/> <input type="button" value="Go Back"/>		

Figure 7: Configuring the RMON history information

You need to set a physical port to be the reception terminal of the monitor data.

The index is used to identify a specific interface; if the index is same to that of the previous application interface, it will replace that of the previous application interface.

The sampling number means the items that need be reserved, whose default value is 50.

The sampling interval means the time between two data collection, whose default value is 1800s.

At present, the monitor statistic information can be obtained through the command line “show rmon history”, but the Web does not support this function.

7.8.2.3 RMON Alarm Information Configuration

If you click Network Management Config -> RMON -> RMON Alarm -> New, the RMON Alarm page appears.

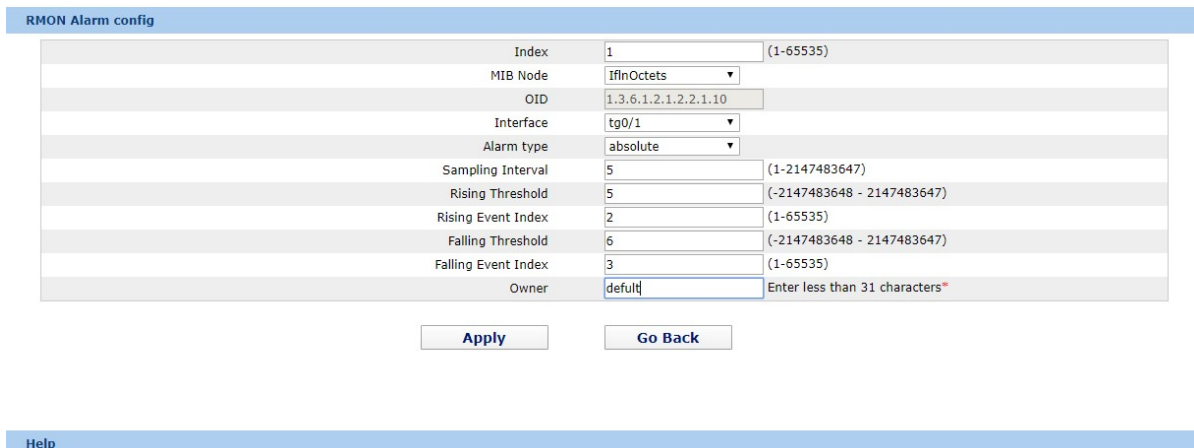

RMON Alarm config		
Index	1	(1-65535)
MIB Node	IfInOctets	
OID	1.3.6.1.2.1.2.1.10	
Interface	tg0/1	
Alarm type	absolute	
Sampling Interval	5	(1-2147483647)
Rising Threshold	5	(-2147483648 - 2147483647)
Rising Event Index	2	(1-65535)
Falling Threshold	5	(-2147483648 - 2147483647)
Falling Event Index	3	(1-65535)
Owner	default	Enter less than 31 characters*
<input type="button" value="Apply"/> <input type="button" value="Go Back"/>		
Help		

Figure 8: Configuring the RMON alarm information

The index is used to identify a specific alarm information; if the index is same to the previously applied index, it will replace the previous one.

The MIB node corresponds to OID.

If the alarm type is absolute, the value of the MIB object will be directly monitored; if the alarm type is delta, the change of the value of the MIB object in two sampling will be monitored.

When the monitored MIB object reaches or exceeds the rising threshold, the event corresponding to the index of the rising event will be triggered.

When the monitored MIB object reaches or exceeds the falling threshold, the event corresponding to the index of the falling event will be triggered.

7.8.2.4 RMON Event Configuration

If you click Network Management Config -> RMON -> RMON Event -> New, the RMON event page appears.

Figure 9: RMON event configuration

The index corresponds to the rising event index and the falling event index that have already been configured on the RMON alarm config page.

The owner is used to describe the descriptive information of an event.

"Enable log" means to add an item of information in the log table when the event is triggered.

"Enable trap" means a trap will be generated if the event is triggered.

7.9 Diagnosis Tools

- Device Status
- Basic Config
- Port Config
- L2 Config
- L3 Config
- Advanced Config
- Network Mgr.
- Diagnostic Tool**

- Ping

- System Mgr.

Figure 1: Diagnosis tool list

7.9.1 Ping

7.9.1.1 Ping

If you click **Diagnosis Tools -> Ping**, the **Ping** page appears.

Ping

Ping is a typical network tool, which is used to identify the states of some network functions. The states of network functions are the basis of regular network diagnosis. Ping is used to check whether the peer is reachable. If Ping transmits a packet to the host and receives a response from the peer, the peer is reachable.

PING test-->	
Destination address*	<input type="text"/>
Source IP address	<input type="text"/> (An option which can be null)
Size of the PING packet	<input type="text"/> (36-20000) (An option which can be null)

Help

#The ping program can test whether a destination can be reached, or it can test the packet loss to reach a destination.

#Destination address: Enter the to-be-tested destination address.

#Source IP: Source IP.

#Packet's size: Designate the size of a packet when the packet is used to ping a destination. It is optional and cannot be configured.

Figure 2: Ping

Ping is used to test whether the switch connects other devices.

If a Ping test need be conducted, please enter an IP address in the “Destination address” textbox, such as the IP address of your PC, and then click the “PING” button. If the switch connects your entered address, the device can promptly return a test result to you; if not, the device will take a little more time to return the test result.

“Source IP address” is used to set the source IP address which is carried in the Ping packet.

“Size of the PING packet” is used to set the length of the Ping packet which is transmitted by the device.

7.10 System Management

- Device Status
- Basic Config
- Port Config
- L2 Config
- L3 Config
- Advanced Config
- Network Mgr.
- Diagnostic Tool
- System Mgr.**

- User Mgr.
- Log Mgr.
- Startup-config
- System Software
- Reboot

Figure 1: Navigation list of system management

7.10.1 User Management

7.10.1.1 User List

If you click System Manage -> User Manage, the User Management page appears.

User Management

No.1 Page/Total 1 Page First Prev Next Last Go No. Page Search: Current 1 Item/Total 1 Item

No.	User name	User permission	Pass-Group	Authen-Group	Author-Group	User Status	Operate
<input type="checkbox"/>	admin	System administrator				Normal	Edit

Select All/Select None

Help

#Note: When only one Admin user exists, You cannot delete the current administrator user. Otherwise, you cannot log on to the switch and configure it.

#Users can be divided into the Admin user and the limited user according to the permission. The Admin user can use all functions of the switch, including browsing, configuring and remote login, while the limited user only has the permission to browse the switch's running state through the WEB page.

#Click the New button to create a new user.

Figure 2: User list

You can click "New" to create a new user.

To modify the permission or the login password, click "Edit" on the right of the user list.



1. Please make sure that at least one system administrator exists in the system, so that you can manage the devices through Web.
2. The limited user can only browse the status of the device.

7.10.1.2 Establishing a New User

If you click "New" on the **User Management** page, the **Creating User** page appears.

User name		<input type="text"/>
Password		<input type="password"/>
Confirming password		<input type="password"/>
Pass-Group		<input type="text"/>
Authen-Group		<input type="text"/>
Author-Group		<input type="text"/>
Apply		Reset Go Back

Figure 3: Creating new users

In the "User name" text box, enter a name, which contains letters, numbers and symbols except "?", "\", "&", "#", and the "Space".

In the "Password" textbox enter a login password, and in the "Confirming password" textbox enter this login password again.

In the "User permission" dropdown box set the user's permission. The "System administrator" user can browse the status of the device and conduct relevant settings, while the limited user can only browse the status of the device.

7.10.2 Log Management

If you click System Manage -> Log Manage, the Log Management page appears.

System logs will be sent to the server when it is enabled	
Enable the log server	<input checked="" type="checkbox"/>
Address of the log server	<input type="text" value="192.168.1.77"/>
Level of system logs	<input type="text" value="(7-debugging)"/>
Enable the log buffer	<input type="checkbox"/>
Size of the log buffer	<input type="text" value="4096"/> (Bytes)
Level of cache logs	<input type="text" value="(7-debugging)"/>
Apply	

Figure 4: Log management

If "Enabling the log server" is selected, the device will transmit the log information to the designated server. In this case, you need enter the address of the server in the "Address of the system log server" textbox and select the log's grade in the "Grade of the system log information" dropdown box.

If "Enabling the log buffer" is selected, the device will record the log information to the memory. By logging on to the device through the Console port or Telnet, you can run the command "show log" to browse the logs which are saved on the device. The log information which is saved in the memory will be lost after rebooting. Please enter the size of the buffer area in the "Size of the system log buffer" textbox and select the grade of the cached log in the "Grade of the cache log information" dropdown box.

7.10.3 Managing the Configuration Files

If you click **System Manage -> Configuration file**, the **Configuration file** page appears.

7.10.3.1 Exporting the Configuration Information



Figure 5: Exporting the configuration file

The current configuration file can be exported, saved in the disk of PC or in the mobile storage device as the backup file.

To export the configuration file, please click the “Export” button and then select the “Save” option in the pop-up download dialog box.

The default name of the configuration file is “startup-config”, but you are suggested to set it to an easily memorable name.

7.10.3.2 Importing the Configuration Information

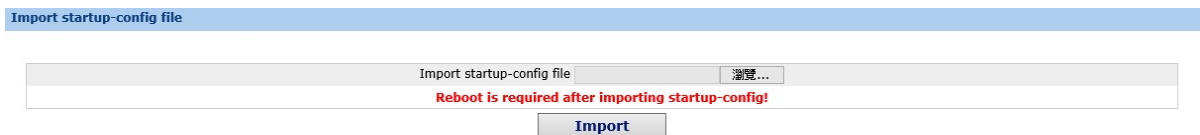

Figure 6: Importing the configuration files

You can import the configuration files from PC to the device and replace the configuration file that is currently being used. For example, by importing the backup configuration files, you can resume the device to its configuration of a previous moment.

1. Please make sure that the imported configuration file has the legal format for the configuration file with illegal format cannot lead to the normal startup of the device.
2. If error occurs during the process of importation, please try it later again, or click the “Save All” button to make the device re-establish the configuration file with the current configuration, avoiding the incomplete file and the abnormality of the device.
3. After the configuration file is imported, if you want to use the imported configuration file immediately, do not click “Save All”, but reboot the device directly.



7.10.4 Software Management

If you click **System Manage -> Software Upgrade**, the software management page appears.

7.10.4.1 Backing up the IOS Software



Figure 7: Backing up IOS

On this page the currently running software version is displayed. If you want to backup IOS, please click “Backuping IOS”; then on the browser the file download dialog box appears; click “Save” to store the IOS file to the disk of the PC, mobile storage device or other network location.



The default name of the IOS file is "Switch.bin", and it is recommended to change it to a name that is easy to identify and find when it is backed up.

7.10.4.2 Upgrading the IOS Software

1. Please make sure that your upgraded IOS matches the device type, because the matchable IOS will not lead to the normal startup of the device.
2. The upgrade of IOS probably takes one to two minutes; when the “updating” button is clicked, the IOS files will be uploaded to the device.
3. If errors occur during upgrade, please do not restart the device or cut off the power of the device, or the device cannot be started. Please try the upgrade again.
4. After the upgrade please save the configuration and then restart the device to run the new IOS.



Figure 8: Upgrading the IOS software

The upgraded IOS is always used to solve the already known problems or to perfect a specific function. If you device run normally, do not upgrade your IOS software frequently.

If IOS need be upgraded, please first enter the complete path of the new IOS files in the textbox on the right of “Upgrading IOS”, or click the “Browsing” button and select the new IOS files on your computer, and then click “Updating”.

7.10.5 Rebooting the Device

If you click **System Manage -> Reboot Device**, the **Rebooting** page appears.



Figure 9: Rebooting the device

If the device need be rebooted, please first make sure that the modified configuration of the device has already been saved, and then click the “Reboot” button.

Chapter 8. Interface Configuration

8.1 Introduction

This section helps user to learn various kinds of interface that our switch supports and consult configuration information about different interface types.

For detailed description of all interface commands used in this section, refer to *Interface configuration command*. For files of other commands appeared in this section, refer to other parts of the manual.

The introduction includes communication information that can be applied to all interface types.

8.1.1 Supported Interface Types

For information about interface types, please refer to the following table.

Interface Type	Task	Reference
Ethernet interface	Configures Ethernet interface. Configures fast Ethernet interface. Configures gigabit Ethernet interface.	<i>Configuring Ethernet Interface</i>
Logical Interface	Loopback interface Null interface VLAN interface	<i>Configuring Logistical Interface</i> The loopback interface and null interface are only configured on layer-3 switch. User can configure the VLAN interface on layer-2 switch.
	Aggregation interface	<i>Configuring Logistical Interface</i>

The two supported kinds of interface: Ethernet interface and logical interface. The Ethernet interface type depends on one device depends on the standard communication interface and the interface card or interfaced module installed on the switch. The logical interface is the interface without the corresponding physical device, which is established by user manually.

The supported Ethernet interfaces of our switch include:

- Ethernet interface
- Fast Ethernet interface
- Gigabit Ethernet interface
- The supported logical interface of our switch include:
- loopback interface

- null interface
- aggregation interface
- vlan interface

8.1.2 Interface Configuration Introduction

The following description applies to the configuration process of all interfaces. Take the following steps to perform interface configuration in global configuration mode.

- (1) Run the **interface** command to enter the interface configuration mode and start configuring interface. At this time, the switch prompt becomes 'config_' plus the shortened form of the interface to be configured. Use these interfaces in terms of their numbers. Numbers are assigned during installation(exworks) or when an interface card are added to the system. Run the **show interface** command to display these interfaces. Each interface that the device supports provides its own state as follows:

```
Switch#show interface
```

```
GigaEthernet1/1 is down, line protocol is down
Hardware is Fast Ethernet, Address is 0009.7cf7.7dc1
MTU 1500 bytes, BW 10000 Kbit, DLY 1000 usec,
reliability 255/255, txload 1/255, rxload 1/255
Encapsulation ARPA, loopback not set
Auto-duplex, Auto-speed
input flow-control is off, output flow-control is off
ARP type: ARPA, ARP Timeout 04: 00: 00
Last input never, output 17: 52: 52, output hang never
Last clearing of "show interface" counters never
Input queue: 0/75/0/0 (size/max/drops/flushes); Total output drops: 0
Queueing strategy: fifo
Output queue : 0/40 (size/max)
5 minute input rate 0 bits/sec, 0 packets/sec
5 minute output rate 0 bits/sec, 0 packets/sec
1 packets input, 64 bytes, 0 no buffer
Received 0 broadcasts, 0 runts, 0 giants, 0 throttles
0 input errors, 0 CRC, 0 frame, 0 overrun, 0 ignored
0 watchdog, 0 multicast, 0 pause input
0 input packets with dribble condition detected
1 packets output, 64 bytes, 0 underruns
0 output errors, 0 collisions, 1 interface resets
0 babbles, 0 late collision, 0 deferred
0 lost carrier, 0 no carrier, 0 PAUSE output
0 output buffer failures, 0 output buffers swapped out
To configure gigabit Ethernet interface g1/1, enter the following content:
```

interface GigaEthernet0/1

The switch prompts “config_g1/1”.

There is no need to add blank between interface type and interface number. For example, in the above line, g 1/1 or g 1/1 is both rights.



- (1) You can configure the interface configuration commands in interface configuration mode. Various commands define protocols and application programs to be executed on the interface. These commands will stay until user exits the interface configuration mode or switches to another interface.
 - (2) Once the interface configuration has been completed, use the show command in the following chapter ‘Monitoring and Maintaining Interface’ to test the interface state.
-

8.2 Interface Configuration

8.2.1 Configuring Interface Common Attribute

The following content describes the command that can be executed on an interface of any type and configures common attributes of interface. The common attributes of interface that can be configured include: interface description, bandwidth and delay and so on.

8.2.1.1 Adding Description

Adding description about the related interface helps to memorize content attached to the interface. This description only serves as the interface note to help identify uses of the interface and has no effect on any feature of the interface. This description will appear in the output of the following commands: **show running-config** and **show interface**. Use the following command in interface configuration mode if user wants to add a description to any interface.

Command	Description
<code>description <i>string</i></code>	Adds description to the currently-configured interface.

For examples relevant to adding interface description, please refer to the following section ‘Interface Description Example’.

8.2.1.2 Configuring Bandwidth

The upper protocol uses bandwidth information to perform operation decision. Use the following command to configure bandwidth for the interface:

Command	Description
<code>bandwidth<i>kilobps</i></code>	Configures bandwidth for the currently configured interface.

The bandwidth is just a routing parameter, which doesn't influence the communication rate of the actual physical interface.

8.2.1.3 Configuring Time Delay

The upper protocol uses time delay information to perform operation decision. Use the following command to configure time delay for the interface in the interface configuration mode.

Command	Description
<code>delaytensofmicroseconds</code>	Configures time delay for the currently configured interface.

The configuration of time delay is just an information parameter. Use this command cannot adjust the actual time delay of an interface.

8.2.2 Monitoring and Maintaining Interface

The following tasks can monitor and maintain interface:

- Checking interface state
- Initializing and deleting interface
- Shutting down and enabling interface

8.2.2.1 Checking Interface State

Our switch supports displaying several commands related to interface information, including version number of software and hardware, interface state. The following table lists a portion of interface monitor commands.

For the description of these commands, please refer to 'Interface configuration command'.

Use the following commands:

Command	Description
<code>show interface [type [slot port]]</code>	Displays interface state.
<code>show running-config</code>	Displays current configuration.

8.2.2.2 Initializing and Deleting Interface

You can dynamically establish and delete logical interfaces. This also applies to the sub interface and channelized interface. Use the following command to initialize and delete interface in global configuration mode:

Command	Description
<code>no interface type [slot port]</code>	Initializes physical interface or deletes virtual interface.

8.2.2.3 Shutting down and Enabling Interface

When an interface is shut down, all features of this interface are disabled, and also this interface is marked as unavailable interface in all monitor command displays. This information can be transmitted to other switches

via dynamic routing protocol.

Use the following command to shutdown or enable an interface in the interface configuration mode:

Command	Description
shutdown	Shuts down an interface.
no shutdown	Enables an interface.

You can use the **show interface** command and the **show running-config** command to check whether an interface has been shut down. An interface that has been shut down is displayed as 'administratively down' in the **show interface** command display. For more details, please refer to the following example in 'Interface Shutdown Example'.

8.2.3 Configuring Logistical Interface

This section describes how to configure a logical interface. The contents are as follows:

- Configuring null interface
- Configuring loopback interface.
- Configuring aggregation interface
- Configuring VLAN interface

8.2.3.1 Configuring Null Interface

The whole system supports only one null interface. Its functions are similar to those of applied null devices on most operating systems. The null interface is always available, but it never sends or receives communication information. The interface configuration command **no ip unreachable** is the only one command available to the null interface. The null interface provides an optional method to filtrate communication. That is, the unwanted network communication can be routed to the null interface; the null interface can function as the access control list.

You can run the following command in global configuration mode to specify the null interface:

Command	Description
interface null0	Enters the null interface configuration state.

The null interface can be applied in any command that takes the interface type as its parameter.

The following case shows how to configure a null interface for the routing of IP 192.168.20.0.

```
ip route 192.168.20.0 255.255.255.0 null 0
```

8.2.3.2 Configuring Loopback Interface

The loopback interface is a logistical interface. It always functions and continues BGP session even in the case that the outward interface is shut down. The loopback interface can be used as the terminal address for BGP session. If other switches try to reach the loopback interface, a dynamic routing protocol should be configured to broadcast the routes with loopback interface address. Messages that are routed to the loopback

interface can be re-routed to the switch and be handled locally. For messages that are routed to the loopback interface but whose destination is not the IP address of the loopback interface, they will be dropped. This means that the loopback interface functions as the null interface.

Run the following command in global configuration mode to specify a loopback interface and enter the interface configuration state:

Command	Description
<code>interface loopbacknumber</code>	Enter the loopback interface configuration state.

8.2.3.3 Configuring Aggregation Interface

The inadequate bandwidth of a single Ethernet interface gives rise to the birth of the aggregation interface. It can bind several full-duplex interfaces with the same rate together, greatly improving the bandwidth.

Run the following command to define the aggregation interface:

Command	Description
<code>Interface port-aggregator number</code>	Configures the aggregation interface

8.2.3.4 Configuring VLAN Interface

V VLAN interface is the routing interface in switch. The VLAN command in global configuration mode only adds layer 2 VLAN to system without defining how to deal with the IP packet whose destination address is itself in the VLAN. If there is no VLAN interface, this kind of packets will be dropped.

Run the following command to define VLAN interface:

Command	Description
<code>Interface vlannumber</code>	Configures VLAN interface.

8.2.3.5 Configuring Super VLAN Interface

The Super VLAN technology provides a mechanism: hosts in different VLANs of the same switch can be allocated in the same Ipv4 subnet and use the same default gateway; lots of IP addresses are, therefore, saved. The Super VLAN technology puts different VLANs into a group where VLANs use the same management interface and hosts use the same IPv4 network section and gateway. VLAN belonging to Super VLAN is called as SubVLAN. No SubVLAN can possess the management interface by configuring IP address. You can configure a Super VLAN interface through a command line. The procedure of configuring a Super VLAN interface is shown as follows:

Command	Description
<code>[no] interface supervlanindex</code>	Enter the Super VLAN interface configuration mode. If the specified Super VLAN interface does not exist, the system will create a Super VLAN interface. index is the index of the Super VLAN interface. Its effective value ranges from 1 to 32.

	no means to delete Super VLAN interface.
<p>[no] subvlan[setstr] [add addstr][removeremstr]</p>	<p>Configure SubVLAN in Super VLAN. The added Sub VLAN cannot possess a management interface or cannot belong to other Super VLANs. In original state, Super VLAN does not contain any Sub VLAN. Only one sub command can only be used every time.</p> <p>setstr means to set the Sub VLAN list. For example, List 2,4-6 indicate VLAN 2, 4, 5 and 6.</p> <p>add means to add VLAN list in the original SubVLAN list. addstr means the character string whose format is the same as the above.</p> <p>remove means to delete VLAN list in the original SubVLAN list. remstr is the list's character string whose format is the same as the above.</p> <p>no means to delete all SubVLANs in SuperVLAN. The no command cannot be used with other sub commands.</p>

After you configure the Super VLAN interface, you can configure the IP address for the Super VLAN interface. The Super VLAN interface is also a routing port, which can be configured as other ports are.

8.3 Interface Configuration Example

8.3.1 Configuring Public Attribute of Interface

8.3.1.1 Interface Description Example

The following example shows how to add description related to an interface. This description appears in the configuration file and interface command display.

```
interface vlan 1
ip address 192.168.1.23 255.255.255.0
```

8.3.1.2 Interface Shutdown Example

The following example shows how to shut down the Ethernet interface 0/1:

```
interface GigaEthernet0/1
shutdown
```

The following example shows how to enable the interface:

```
interface GigaEthernet0/1
no shutdown
```

Chapter 9. Interface Range Configuration

9.1 Interface Range Configuration Task

9.1.1 Understanding Interface Range

In the process of configuring interface tasks, there are cases when you have to configure the same attribute on ports of the same type. In order to avoid repeated configuration on each port, we provide the **interface range** configuration mode. You can configure ports of the same type and slot number with the same configuration parameters. This reduces the workload.



when entering the **interface range** mode, all interfaces included in this mode must have been established.

9.1.2 Entering Interface Range Mode

Run the following command to enter the **interface range** mode.

Step	Command	Description
1	<code>interface rangetypeslot/<port1 - port2 port3>[, <port1 - port2 port3>]</code>	<p>Enters the range mode. All ports included in this mode accord to the following conditions:</p> <ul style="list-style-type: none"> (1) The slot number is set to slot. (2) The port numbers before/after the hyphen must range between port1 and port2, or equal to port3. (3) Port 2 must be less than port 1 (4) There must be space before/after the hyphen or the comma.

9.1.3 Configuration Example

Enter the interface configuration mode via the following commands, including slot 0 and fast Ethernet 1,2,3,6,8,10,11,12:

```
switch_config#interface range 1 - 3 , 6 , 8 , 10 - 12
```

```
switch_config_if_range#
```

Chapter 10. Port Physical Characteristics Configuration

10.1 Configuring the Ethernet Interface

The section describes how to configure the Ethernet interface. The switch supports the 10Mbps Ethernet and the 100Mbps fastEthernet. The detailed configuration is shown as follows. The step described in section 1.1.1 is mandatory. Steps described in other sections are optional.

10.1.1 Selecting Ethernet Interface

Run the following command in global configuration mode to enter the Ethernet interface configuration mode:

Run...	To...
interface fastethernet [slot port]	Enter the fastEthernet interface configuration mode
interface gigaethernet [slot port]	Enter the gigabit Ethernet interface configuration mode.

You can run the **show interface fastethernet** command to display the state of fastEthernet interface. You can run the **show interface gigaethernet** command to display the state of the gigabit Ethernet interface.

10.1.2 Configuring Rate

The Ethernet rate can be realized through auto-negotiation or configuration on the interface.

Run the following command to configure the Ethernet rate:

Run...	To...
Speed {10 100 1000 auto}	Set the rate of fast Ethernet to 10M, 100M, 1000M or auto-negotiation.
No speed	Resume the default settings—auto-negotiation.



The speed of the optical interface is fixed. For example, the rate of GBIC and GE-FX is 1000M; the rate of FE-FX is 100M. If the **auto** parameter is behind the **speed** command, it means that you can enable the auto-negotiation function on the optical interface. Otherwise, you cannot enable the auto-negotiation function on the optical interface.

10.1.3 Configuring Flow Control on the Interface

When the interface is in full-duplex mode, the flow control is achieved through the PAUSE frame defined by

802.3X. When the interface is in half-duplex mode, the flow control is achieved through back pressure.

Run...	To...
flow-control on/off	Enable or disable the flow control on the interface.
no flow-control	Resume the default settings. The default settings have no flow control.

Chapter 11. Port Additional Characteristics

Configuration Interface Configuration

11.1 Configuring the Ethernet Interface

The switch supports the 10Mbps/100Mbps Ethernet interfaces. See the following content for detailed configuration. Among the configuration, the first step is mandatory while others are optional.

11.1.1 Configuring Flow Control for the Port

You can control the flow rate on the incoming and outgoing ports through configuration.

Run the following commands in privileged mode to limit the flow rate of the port.

Each band is defaulted as 128 kbps.

Command	Purpose
configure	Enters the global configuration mode.
interface f1/0	Enters the to-be-configured port.
[no] switchport rate-limit band { ingress egress}	Configures the flow rate limits for the port. The parameter band represents the to-be-limited flow rate. The parameter ingress means the function works at the incoming port. The parameter egress means the function works at the outgoing port.
exit	Exits the global configuration mode.
exit	Returns the EXEC mode.

11.1.2 Configuring the Rate Unit for the Port

Run the following commands to modify the rate unit of the flow on a port. The rate unit can be one of these values: 16K, 64K, 128K, 1M, 10M and 40M.

Command	Purpose
Configure	Enters the global configuration mode.
[no] rate-unit count	Configures the rate unit for a port.
exit	Returns the EXEC mode.

11.1.3 Configuring the Storm Control on the Port

The ports of the switch may receive the attack by the continuous abnormal unicast (MAC address lookup failing), multicast or broadcast message. In this case, the attacked ports or the whole switch may break down.

The storm control mechanism of the port is therefore generated.

Command	Purpose
storm-control {broadcast multicast unicast} threshold count	Performs the storm control to the broadcast/multicast/unicast message.
no storm-control {broadcast multicast unicast} threshold	Cancels the storm control.

11.2 Secure Port Configuration

11.2.1 Overview

You can control the access function of the secure port, enabling the port to run in a certain range according to your configuration. If you enable the security function of a port through configuring the number of secure MAC addresses for the port. If the number of secure MAC addresses exceeds the upper limitation and MAC addresses are insecure, secure port violation occurs. You should take actions according to different violation modes.

The secure port has the following functions:

- Configuring the number of secure MAC addresses
- Configuring static secure MAC addresses
If the secure port has no static secure MAC address or the number of static secure MAC addresses is smaller than that of secure MAC addresses, the port will learn dynamic MAC addresses.
- Dropping violated packets when secure port violation occurs

The section describes how to configure the secure port for the switch.

11.2.2 Configuration Task of the Secure Port

- Configuring Secure Port Mode
- Configuring the Static MAC Address of the Secure Port

11.3 Configuring the Secure Port

11.3.1 Configuring the Secure Port Mode

There are two static secure port modes: accept and reject. If it is the **accept** mode, only the flow whose source address is same to the local MAC address can be received by the port for communication. If it is the **reject** mode, only the flow whose source address is different to the local MAC address can be received by the port.

Run the following commands in EXEC mode to enable or disable the secure port function:

Command	Purpose
configure	Enters the global configuration mode.

interface g0/1	Enters the to-be-configured port.
[no] switchport port-security mode static {accept reject}	Configures the secure port mode.
exit	Goes back to the global configuration mode.
exit	Goes back to the EXEC mode.
write	Saves the configuration.

11.3.2 Configuring the Static MAC Address of the Secure Port

After you configure the static MAC address of the secure port, In **accept** mode, the flow whose source address is same to the local MAC address can be received by the port for communication. In **reject** mode, the flow whose source address is different to the local MAC address can be received by the port.

Run the following commands in EXEC mode to configure the static MAC address of the secure port:

Command	Purpose
configure	Enters the global configuration mode.
interface g0/1	Enters the to-be-configured port.
[no] switchport port-security static mac-address mac-addr	Adds or deletes the static MAC address of the secure port. <ul style="list-style-type: none"> • mac-addr is the configured MAC address.
exit	Goes back to the global configuration mode.
exit	Goes back to the EXEC mode.
write	Saves the configuration.

Chapter 12. Configuring Port Mirroring

Configuring Port Mirroring Task List

- Configuring port mirroring
- Displaying port mirroring information

12.1 Configuring Port Mirroring Task

12.1.1 Configuring Port Mirroring

Through configuring port mirroring, you can use one port of a switch to observe the traffic on a group of ports.

Enter the privilege mode and perform the following steps to configure port mirroring:

Command	Description
configure	Enters the global configuration mode.
mirror session <i>session_number</i> {destination {interface <i>interface-id</i> } source {interface <i>interface-id</i> [, -]rx } }	Configures port mirroring. session-number is the number of the port mirroring. destination is the destination port of the mirroring. source is the source port of mirroring. rx means the input data of mirroring.
exit	Enters the management mode again.
write	Saves the configuration.

12.1.2 Displaying Port Mirroring Information

Run show to display the configuration information of port mirroring.

Command	Description
show mirror [session <i>session_number</i>]	Displays the configuration information about port mirroring. session-number is the number of the port mirroring.

Chapter 13. Configuring MAC Address Attribute

13.1 MAC Address Configuration Task List

- Configuring Static Mac Address
- Configuring Mac Address Aging Time
- Configuring VLAN-shared MAC Address
- Displaying Mac Address Table
- Clearing Dynamic Mac Address

13.2 MAC address Configuration Task

13.2.1 Configuring Static Mac Address

Static MAC address entries are MAC address entries that do not age by the switch and can only be deleted manually. According to the actual requirements during the operation process, you can add and delete a static MAC address. Use the following command in privileged level to add and delete a static MAC address.

Command	Purpose
configure	Enters the global configuration mode.
[no] mac address-table static mac-addr vlan <i>vlan-id</i> interface <i>interface-id</i>	Adds/deletes a static MAC address entry. Mac-addr indicates the MAC address. Vlan-id indicates the VLAN number. Valid value is from 1~4094. Interface-id indicates the interface name.
exit	Returns to EXEC mode.
write	Saves configuration.

13.2.2 Configuring MAC Address Aging Time

When a dynamic MAC address is not used during the specified aging time, the switch will delete this MAC address from the MAC address table. The aging time of the switch MAC address can be configured in terms of needs. The default aging time is 300 seconds.

Configure the aging time of MAC address in the privileged mode as follows:

Command	Purpose
configure	Enters the global configuration mode
mac address-table aging-time [0 10-1000000]	Configures the aging time of MAC address.

	0 indicates no-age of the MAC address. Valid value is from 10 to 1000000 in seconds.
exit	Returns to the management mode.
write	Saves configuration.

13.2.3 Displaying MAC Address Table

Since debugging and management are required in operation process, we want to know content of the switch MAC address table. Use the show command to display content of the switch MAC address table.

Command	Purpose
show mac address-table {dynamic [interface interface-id vlan vlan-id] static}	Displays content of the MAC address table. Dynamic indicates the MAC address that acquires dynamically. Vlan-id indicates the VLAN number. Valid value is from 1 to 4094. Interface-id indicates the interface name. Static indicates the static MAC address table.

13.2.4 Clearing Dynamic MAC Address

The acquired MAC addresses need to be cleared in some circumstances.

Use the following command to delete a dynamic MAC address in privileged mode:

Command	Purpose
clear mac address-table dynamic [address mac-addr interface interface-id vlan vlan-id]	Deletes a dynamic MAC address entry. Dynamic indicates the MAC address that dynamically acquires. Mac-addr is the MAC address. Interface-id indicates the interface name. Vlan-id indicates the VLAN number. Valid value is from 1 to 4094.

Chapter 14. Configuring MAC List

14.1 MAC List Configuration Task

14.1.1 Creating MAC List

To apply the MAC list on the port, you must first create the MAC list. After the MAC list is successfully created, you log in to the MAC list configuration mode and then you can configure items of the MAC access list.

Perform the following operations to add and delete a MAC list in privilege mode:

Run...	To...
configure	Log in to the global configuration mode.
[no] mac access-listname	Add or delete a MAC list. name means the name of the MAC list.

14.1.2 Configuring Items of MAC List

You can use the permit or deny command to configure the permit or deny items of the MAC list. Multiple permit or deny items can be configured on a MAC list.

The mask of multiple items configured in a MAC list must be the same. Otherwise, the configuration may be out of effect (see the following example). The same item can only be configured once in the same MAC address.

Perform the following operations in MAC list configuration mode to configure the items of the MAC list:

Run...	To...
[no] {deny permit} {any host src-mac-addr} {any host dst-mac-addr}[ethertype]	Add/Delete an item of the MAC list. You can rerun the command to add or delete multiple items of the MAC list. any means any MAC address can be compatible; src-mac-addr means the source MAC address; dst-mac-addr means the destination MAC address. ethertype means the type of matched Ethernet packet.
exit	Log out from the MAC list configuration mode and enter the global configuration mode again.

exit	Enter the management mode again.
write	Save configuration.

MAC list configuration example

Switch_config#mac acce 1

Switch-config-macl#permit host 1.1.1 any

Switch-config-macl#permit host 2.2.2 any

The above configuration is to compare the source MAC address, so the mask is the same. The configuration is successful.

Switch_config#mac acce 1

Switch-config-macl#permit host 1.1.1 any

Switch-config-macl#permit any host 1.1.2

Switch-config-macl#2003-11-19 18: 54: 25 rule conflict,all the rule in the acl should match!

The first line on the above configuration is to compare source MAC addresses, while the second line is to compare destination MAC addresses. Therefore, the mask is different. The configuration fails.

14.1.3 Applying MAC List

The created MAC list can be applied on any physical port. Only one MAC list can be applied to a port. The same MAC list can be applied to multiple ports.

Enter the privilege mode and perform the following operation to configure the MAC list.

Run...	To...
configure	Enter the global configuration mode.
interface f0/1	Log in to the port that is to be configured.
[no] mac access-group name	Apply the created MAC list to the port or delete the applied MAC list from the port. name means the name of the MAC list.
exit	Enter the global configuration mode again.
exit	Enter the management mode again.
write	Save configuration.

Chapter 15. Configuring 802.1x

15.1 802.1x Configuration Task List

- Configuring 802.1x port authentication
- Configuring 802.1x multiple port authentication
- Configuring maximum times for 802.1x ID authentication
- Configuring 802.1x re-authentication
- Configuring 802.1x transmission frequency
- Configuring 802.1x user binding
- Configuring authentication method for 802.1x port
- Selecting authentication type for 802.1x port
- Configuring 802.1x accounting
- Configuring guest-vlan
- Forbidding Supplicant with multiple network cards
- Resuming default 802.1x configuration
- Monitoring 802.1x authentication configuration and state

15.2 802.1x Configuration Task

15.2.1 Configuring 802.1x Port Authentication

802.1x defines three control methods for the port: mandatory authentication approval, mandatory authentication disapproval and 802.1x authentication startup.

Mandatory authentication approval means the port has already passed authentication. The port does not need any authentication any more, and all users can perform data access control through the port. The authentication method is defaulted by the port. Mandatory authentication disapproval means the port authentication does not get passed no matter what kind of method is applied. No user can perform the data access control through the port.

802.1x authentication startup means the port is to run 802.1x authentication protocol. 802.1x authentication will be applied to users who access the port. Only users who pass the authentication can perform data access control through the port. After the 802.1x authentication is started up, the AAA authentication method must be configured.

Run the following command to enable the 802.1x function before configuring 802.1x:

Run...	To...
dot1x enable	Enable the 802.1x function.

Run the following command to start up the 802.1x authentication:

Run...	To...
dot1x port-control auto	Configure the 802.1x protocol control method on the port.
aaa authentication dot1x {default list name} method	Configure the AAA authentication of 802.1x.

Run one of the following commands in port configuration mode to select 802.1x control method:

Run...	To...
dot1x port-control auto	Start up the 802.1x authentication method on the port.
dot1x port-control force-authorized	Approve the mandatory port authentication.
dot1x port-control force-unauthorized	Disapprove the mandatory port authentication.

15.2.2 Configuring 802.1x Multiple Port Authentication

802.1x authentication is for the authentication of single host user. In this case, the switch allows only one user to perform authentication and access control. Other users cannot be authenticated and access unless the previous user exits authentication and access. In the case the port connects multiple hosts through switch devices, such as 1108 switch, that do not support 802.1x, you can start up the multiple port access function to make sure that all host users can access.

After a port is configured to multiple host authentication of 802.1x, the switch authenticates different host users. When authentication is approved, the host will be allowed to access through the switch (the MAC address of host is used for control). Theoretically, 802.1x cannot limit the number of host users. Because the switch controls the user authentication through the MAC address of user, the number of host users will be limited by the size of the MAC address table of the switch.

Run the following command in interface configuration mode to activate 802.1x multiple host authentication:

Run...	To...
dot1x multiple-hosts	Set the 802.1x multiple port authentication.

15.2.3 Configuring Maximum Times for 802.1x ID Authentication

When 802.1x authentication starts or 802.1x authentication is being performed again, 802.1x sends ID authentication request to guest hosts. If the request message is dropped or delayed because network problems, the requirement message will be sent again. If the message is resent certain times, 802.1x stops to send the message and the ID authentication fails.

You can reset the maximum times of ID authentication request according to different network conditions, ensuring the clients are authenticated successfully by the authentication server.

Run the following command in interface configuration command to set the maximum times for ID authentication request:

Run...	To
dot1x max-req count	Set the maximum times for ID authentication request.

15.2.4 Configuring 802.1x Re-authentication

After first authentication is approved, the client will be authenticated every a certain time to ensure the legality of the client. In this case, the re-authentication function needs to be enabled.

After the re-authentication function is enabled, 802.1x will periodically send the authentication request to the host.

You can run the following commands to configure the re-authentication function.

Run...	To...
dot1x re-authentication	Enable the re-authentication function.
dot1x timeout re-authperiod time	Configure the period of re-authentication.
dot1x reauth-max time	Configure the retry times after the re-authentication fails.

15.2.5 Configuring 802.1x Transmission Frequency

In the process of 802.1x authentication, data texts will be sent to the host. The data transmission can be adjusted by controlling 802.1x transmission frequency so that the host response is successful.

Run the following command to configure the transmission frequency:

Run...	To...
dot1x timeout tx-period time	Set the message transmission frequency of 802.1x.

15.2.6 Configuring 802.1x User Binding

When 802.1x authentication is performed, you can bind a user to a certain port to ensure the security of port access. Run the following command in interface configuration mode to start up 802.1x user binding.

Run...	To...
dot1x user-permitxxxz	Configure a user that is bound to a port.

15.2.7 Configuring Authentication Method for 802.1x Port

The 802.1x authentication can be performed in different methods at different ports. In the default configuration, the 802.1x authentication adopts the **default** method.

Run the following command in interface configuration mode to configure the method of the 802.1x

authentication:

Run...	To...
dot1x authentication method yyy	Configure the method of the 802.1x authentication.

15.2.8 Selecting Authentication Type for 802.1x Port

You can select the type for the 802.1x authentication. The 802.1x authentication type determines whether AAA uses Chap authentication or Eap authentication. Eap authentication supports the md5-challenge mode and the eap-tls mode. Challenge required by MD5 is generated locally when the Chap authentication is adopted, while challenge is generated at the authentication server when the eap authentication is adopted. Each port adopts only one authentication type. The authentication type of global configuration is adopted by default. Once a port is set to an authentication type, the port will use the authentication type unless you run the **No** command to resume the default value.

Eap-tls takes the electronic certificate as the authentication warrant and complies with the handshake rules in Translation Layer Security (tls). Therefore, high security is guaranteed.

Run the following command in global configuration mode to configure the authentication type:

Run...	To...
dot1x authen-type {chap eap}	Select chap or eap.

Also run the following command in interface configuration mode:

Run...	To...
dot1x authentication type {chap eap}	Select chap or eap or the configured authentication type in global mode.

15.2.9 Configuring 802.1x Accounting

The 802.1x authentication and 802.1x accounting can be performed at the same time. Its working mechanism is: after the dot1x authentication is approved, judge whether the accounting function is enabled on the authentication interface; if the accounting function is enabled, send the accounting request through the AAA interface; when the AAA module returns successful request response message, the AAA interface can forward texts.

The accounting can adopt various accounting methods configured in the AAA module. For details, refer to AAA configuration.

After the beginning of accounting, dot1x periodically sends **update** message to the server through the AAA interface for obtaining correct accounting information. According to different AAA configuration, the AAA module decides whether to send the **update** message.

At the same time, you are required to enable the dot1x re-authentication function so that the switch can know when supplicant is abnormal.

Run the following commands in interface configuration mode to enable the dot1x accounting and to configure

the accounting method:

Run...	To...
dot1xaccounting enable	Enable the dot1x accounting.
dot1x accounting method {method name}	Configure the accounting method. Its default value is default .

15.2.10 Configuring 802.1x guest-vlan

Guest-vlan gives relevant ports some access rights (such as downloading client software) when the client does not respond. Guest-vlan can be any configured vlan in the system. If the configured guest-vlan does not meet the conditions, ports cannot run in the guest-vlan.



There is no access right if the authentication fails.

Run the following command in the global mode to enable the guest-vlan:

Run...	To...
Dot1x guest-vlan	Enable the guest-vlan at all ports.

When the original value of **guest-vlan id** at each port is 0, guest-vlan cannot function even if guest-vlan is enabled in global mode. Only when **guest-vlan id** is configured in port configuration mode, guest-vlan can function.

Run the following command in port configuration mode to configure **guest-vlan id**:

Run...	To...
Dot1x guest-vlan {id(1-4094)}	Enable guest-vlan at all ports.

15.2.11 Forbidding Supplicant with Multiple Network Cards

Forbid the Supplicant with multiple network adapters to prevent agents. Run the following command in port configuration mode:

Run...	To...
dot1x forbid multi-network-adapter	Forbid the Supplicant with multiple network adapters.

15.2.12 Resuming Default 802.1x Configuration

Run the following command to resume all global configuration to default configuration:

Run...	To...
dot1x default	Resume all global configuration to default configuration.

15.2.13 Monitoring 802.1x Authentication Configuration and State

To monitor the configuration and state of 802.1x Authentication and decide which 802.1x parameter needs to be adjusted, run the following command in management mode:

Run...	To...
show dot1x { <i>interface ...</i> }	Monitor the configuration and state of 802.1x authentication.

15.3 802.1x Configuration Example

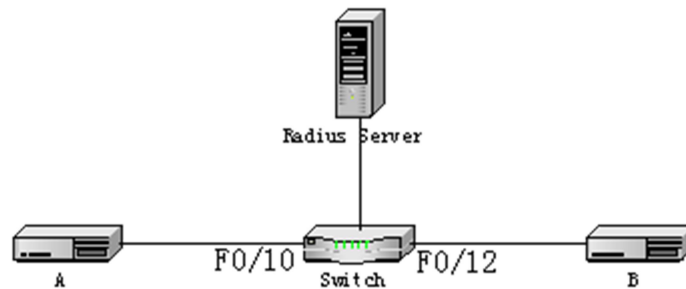

Host A connects port F0/10 of the switch. Host B connects port F0/12. The IP address of the radius-server host is 192.168.20.2. The key of radius is TST. Port F0/10 adopts remote radius authentication and user binding. Port F0/12 adopts local authentication of eap type, and Multi-hosts are enabled at Port F0/12.

Global configuration

```

username switch password 0 TST
username TST password 0 TST
aaa authentication dot1x TST-F0/10 radius
aaa authentication dot1x TST-F0/12 local
interface VLAN1
ip address 192.168.20.24 255.255.255.0
radius-server host 192.168.20.2 auth-port 1812 acct-port 1813
radius-server key TST
  
```

Configuring port F0/10

```

interface FastEthernet0/10
dot1x port-control auto
dot1x authentication method TST-F0/10
dot1x user-permit radius-TST
  
```

Configuring port F0/12

```

interface FastEthernet0/12
dot1x multiple-hosts
  
```

dot1x port-control auto

dot1x authentication method TST-F0/12

dot1x authentication type eap

Chapter 16. VLAN Configuration

16.1 VLAN Introduction

Virtual LAN (VLAN) refers to a group of logically networked devices on one or more LANs that are configured so that they can communicate as if they were attached to the same wire, when in fact they are located on a number of different LAN segments. In 1999 IEEE established IEEE 802.1Q Protocol Standard Draft used to standardize VLAN realization project. Because VLANs are based on logical instead of physical connections, it is very flexible for user/host management, bandwidth allocation and resource optimization.

There are the following types of Virtual LANs:

- Port-Based VLAN: each physical switch port is configured with an access list specifying membership in a set of VLANs.
- 802.1Q trunk mode is supported on the interface.
- Access mode interface is supported.
- Port-Based Vlan is to ascribe port to one subset of vlan that the switch supports. If this vlan subset has only one vlan, then this port is access port. If this vlan subset has multiple vlan, then this port is trunk port. There is one default vlan among the multiple vlan, and the vlan id is the port vlan id (PVID).
- Vlan-allowed range is supported on the interface.
- Vlan-allowed parameter is used to control vlan range that the port belongs. Vlan-untagged parameter is used to configure port to send packets without vlan tag to the corresponding vlan.

16.2 VLAN Configuration Task List

- Adding/Deleting VLAN
- Configuring switch port
- Creating/Deleting VLAN interface
- Monitoring configuration and state of VLAN

16.3 VLAN Configuration Task

16.3.1 Adding/Deleting VLAN

A virtual LAN, commonly known as a VLAN, is a group of hosts with a common set of requirements that communicate as if they were attached to the same wire, regardless of their physical location. A VLAN has the same attributes as a physical LAN, but it allows for end stations to be grouped together even if they are not located on the same LAN segment. A VLAN may have multiple ports and all unicast, multicast and broadcast message can only be forwarded from the same VLAN to the terminal. Each VLAN is a logistical network. If the data wants to reach another VLAN, it must be forwarded by router or bridge.

Run the following command to configure VLAN

Run...	To...
vlan vlan-id	Enter the VLAN configuration mode.
name str	Name in the vlan configuration mode.
Exit	Exit vlan configuration mode, and establish vlan.
vlan vlan-range	Establish multiple VLANs at the same time.
no vlan vlan-id vlan-range	Delete one or multiple VLANs.

Vlan can perform dynamic addition and deletion via vlan management protocol GVRP.

16.3.2 Configuring Switch Port

The switch port supports the following modes: access mode, trunk mode and dot1q-tunnel mode.

- The access mode indicates that this port is only subordinate to one vlan and only sends and receives untagged ethernet frame.
- The trunk mode indicates that this port is connected to other switches and can send and receive tagged ethernet frame.
- The dot1q-tunnel mode takes unconditionally the received packets as the ones without tag. The switch chip automatically adds pvid of the port as the new tag, therefore allowing switch to ignore the different vlan partitions that connected to the network. Then the packet will be delivered unchangedly to the other port in the other subnetwork of the same customer. The transparent transmission is realized in this way.

Each port has one default vlan and pvid, and all the data without vlan tag received on the port belong to the data packets of the vlan.

Trunk mode can ascribe port to multiple vlan and also can configure which kind of packet to forward and the number of vlan that belongs, that is, the packet sent on the port is tagged or untagged, and the vlan list that the port belongs.

Run the following command to configure the switch port:

Run...	To...
switchport pvid <i>vlan-id</i>	Configure pvid of switch port.
switchport mode access trunk dot1q-tunnel	Configure port mode of the switch.
switchport trunk vlan-allowed ...	Configure vlan-allowed range of switch port.
switchport trunk vlan-untagged ...	Configure vlan-untagged range of switch port.



Not all switches support dot1q-tunnel feature. Some switches only support globally enabling/disabling this feature, and cannot configure different strategies for different ports.

The command to globally enable dot1q-tunnel is as follows:

Command	Description
double-tagging	Globally enables double-tagging feature of the switch.

16.3.3 Creating/Deleting VLAN Interface

Vlan interface can be established to realize network management or layer 3 routing feature. The vlan interface can be used to specify ip address and mask. Run the following command to configure vlan interface:

Run...	To...
[no] interface vlan <i>vlan-id</i>	Create/Delete a VLAN interface.

16.3.4 Configuring Super VLAN Interface

The Super VLAN technology provides a mechanism: Hosts in different VLANs that run the same switch can be allocated in the same Ipv4 subnet; lots of IP addresses are, therefore, saved. The Super VLAN technology classifies different VLANs into a group. The VLANs in this group uses the same management interface. Hosts in the group use the same IPv4 network section and gateway. VLAN belonging to Super VLAN is called as SubVLAN. No SubVLAN can possess the management interface by configuring IP address.

You can configure a Super VLAN interface through the command line. The procedure of configuring a Super VLAN interface is shown as follows:

Command	Description
[no] interface <i>supervlanindex</i>	Enters the interface configuration mode . If the specified Super VLAN interface does not exists, the system will create a Super VLAN interface. <i>index</i> is the index of Super VLAN interface. Its effective value ranges from 1 to 32. <i>no</i> means deleting Super VLAN interface.
[no] subvlan[<i>setstr</i>] [add <i>addstr</i>] [remove <i>remstr</i>]	Configures SubVlan in Super VLAN. The added Sub VLAN cannot possess the management interface. In original state, Super VLAN does not include Sub VLAN. Only one sub command can be used every time. <i>setstr</i> means to set the Sub VLAN list. For example, List 2,4-6 indicate VLAN 2, 4, 5 and 6. <i>add</i> means to add VLAN list in the original SubVLAN list. <i>addstr</i> means the character string whose format is the same as the above. <i>remove</i> means to delete VLAN list in the original SubVLAN list. <i>remstr</i> is the list's character string whose format is the same as the above. <i>no</i> means to delete all SubVLANs in SuperVLAN. The <i>no</i> command cannot be used with other sub commands.

After you configure the Super VLAN interface, you can configure the IP address for the Super VLAN interface. The Super VLAN interface is also a routing port, which can be configured as other ports are.

16.3.5 Monitoring Configuration and State of VLAN

Run the following commands in EXEC mode to monitor configuration and state of VLAN:

Run...	To...
show vlan [idx interface <i>intf</i>]	Display configuration and state of VLAN.
show interface {vlan supervlan} x	Display the states of vlan ports.

16.4 Configuration Examples

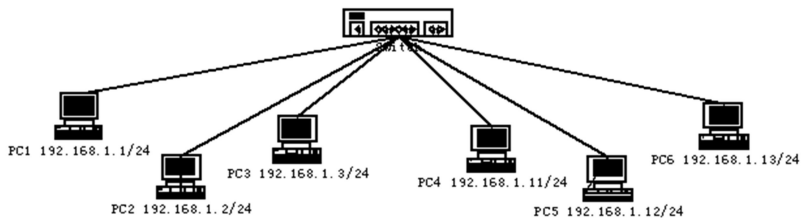

Users PC1~PC6 connect the switch through ports 1~6. The IP addresses of these PCs belong to the network section 192.168.1.0/24. Though group PC1~PC3 and group PC4~PC6 are located at different layer-2 broadcast domains, PC1~PC6 can ping each other and manage the switch through the IP address 192.168.1.100. To do this, you need to configure port 1~3 to VLAN1 and port 4~6 to VLAN. Then you need to add VLAN 1 and 2 to a SuperVlan as its SubVLANs. You need to perform the following configuration on the switch:

```
interface fastethernet 0/4
switchport pvid 2
!
interface fastethernet 0/5
switchport pvid 2
!
interface fastethernet 0/6
switchport pvid 2
!
interface supervlan 1
subvlan 1,2
ip address 192.168.1.100 255.255.255.0
ip proxy-arp subvlan
```

Chapter 17. GVRP Configuration

17.1 Configuring GVRP

17.2 Introduction

GVRP (GARP VLAN Registration Protocol GARP VLAN) is a GARP (GARP VLAN Registration Protocol GARP VLAN) application that provides IEEE 802.1Q-compliant VLAN pruning and dynamic VLAN creation on 802.1Q trunk ports.

With GVRP, the switch can exchange the VLAN configuration information with the other GVRP switches, prune the unnecessary broadcast and unknown unicast traffic, and dynamically create and manage the VLANs on the switches that are connected through the 802.1Q trunk ports.

17.3 Configuring Task List

17.3.1 GVRP Configuration Task List

- Enabling/Disabling GVRP Globally
- Enabling/Disabling GVRP on the Interface
- Monitoring and Maintenance of GVRP

17.4 GVRP Configuration Task

17.4.1 Enabling/Disabling GVRP Globally

Perform the following configuration in global configuration mode.

Command	Description
[no] gvrp	Enables/disables GVRP globally.

It is disabled by default.

17.4.2 Enabling/Disabling GVRP on the Interface

Perform the following configuration in interface configuration mode:

Command	Description
[no] gvrp	Enables/disables interface GVRP.

In order for the port to become an active GVRP participant, you must enable GVRP globally first and the port must be an 802.1Q trunk port,

It is enabled by default.

17.4.3 Monitoring and Maintenance of GVRP

Perform the following operations in EXEC mode:

Command	Description
show gvrp statistics [interface port_list]	Displays GVRP statistics.
show gvrp status	Displays GVRP global state information.
[no] debug gvrp [packet event]	Enables/disables GVRP data packet and event debug switches. All debug switches will be enabled/disabled if not specified the concrete switch.

Display GVRP statistics:

```
switch#show gvrp statistics interface Tthernet0/1
```

GVRP statistics on port Ethernet0/1

GVRP Status: Enabled

GVRP Failed Registrations: 0

GVRP Last Pdu Origin: 0000.0000.0000

GVRP Registration Type: Normal

Display GVRP global state information:

```
switch#show gvrp status
```

gvrp is enabled!

17.5 Configuration Example

The network connection is as follows. In order to make the VLAN configuration information of Switch A and Switch B identical, you can enable GVRP on Switch A and Switch B. The configuration is as follows:

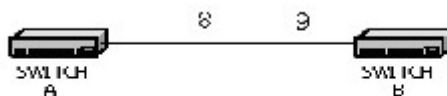

- (1) Configure the interface 8 that Switch A connects to Switch B to trunk:

```
Switch_config_g0/8# switchport mode trunk
```

- (2) Enable global GVRP of switch A:

```
Switch_config#gvrp
```

- (3) Enable GVRP of interface 8 of Switch A:

```
Switch_config_g0/8#gvrp
```

- (4) Configure VLAN 10, Vlan 20 and Vlan30 on Switch A

```
Switch_config#vlan 10
```

```
Switch_config#vlan 20
```

```
Switch_config#vlan 30
```

- (5) Configure the interface 9 that Switch A connects to Switch B to trunk:

```
Switch_config_g0/9# switchport mode trunk
```

- (6) Enable global GVRP of switch B:

```
Switch_config#gvrp
```

- (7) Enable GVRP of interface 9 of Switch B

```
Switch_config_g0/9#gvrp
```

- (8) Configure VLAN 40, Vlan 50 and Vlan60 on Switch B

```
Switch_config#vlan 40
```

```
Switch_config#vlan 50
```

```
Switch_config#vlan 60
```

After completing the configuration, the VLAN configuration information will be displayed respectively on Switch A and Switch B, that is, VLAN10, VLAN20,VLAN30, VLAN40, VLAN50 and VLAN60 on both switches.

Chapter 18. Private VLAN Settings

18.1 Private VLAN Settings

18.2 Overview of Private VLAN

Private VLAN has settled the VLAN application problems facing ISPs: If ISP provides each user with a VLAN, the support by each device of 4094 VLANs will restrict the total of ISP-supported users.

18.3 Private VLAN Type and Port Type in Private VLAN

Private VLAN subdivides the L2 broadcast domain of a VLAN into multiple sub-domains, each of which consists of a private VLAN pair: a primary VLAN and a secondary VLAN. One private VLAN domain may have multiple private VLAN pairs and each private VLAN pair stands for a sub-domain. There is only one primary VLAN in a private VLAN domain and all private VLAN pairs share the same primary VLAN. The IDs of secondary VLANs in each sub-domain differ with each other.

18.3.1 Having One Primary VLAN Type

- Primary VLAN: It is relevant to a promiscuous port and only one primary VLAN exists in the private VLAN. Each port in the primary VLAN is a member in the primary VLAN.

18.3.2 Having Two Secondary VLAN Types

- Isolated VLAN: No layer-2 communication can be conducted between two ports in the same isolated VLAN. Also, there is only one isolated VLAN in a private VLAN. The isolated VLAN must be related with the primary VLAN.
- Community VLAN: Layer-2 communication can be conducted between two ports in the same VLAN, but they have no communication with the ports in another community VLAN. One private VLAN may contain multiple community VLANs. The community VLAN must be related with the primary VLAN.

18.3.3 Port Types Under the Private VLAN Port

- Promiscuous port: it belongs to the primary VLAN. It can communicate with all other ports, including the isolated port and community port of a secondary VLAN in the same private VLAN.
- Isolated port: It is the host port in the isolated VLAN. In the same private VLAN, the isolated port is totally L2 isolated from other ports except the promiscuous port, so the flows received from the isolated port can only be forwarded to the promiscuous port.
- Community port: It is the host port in the community VLAN. In a private VLAN, the community ports of

the same community VLAN can conduct L2 communication each other or with the promiscuous port, but not with the community ports of other VLANs and the isolated ports in the isolated VLANs.

18.3.4 Modifying the Fields in VLAN TAG

This functionality supports to modify the VLAN ID and priority in VLAN tag and decides whether the egress packets of private VLAN carry the tag or not.

18.4 Private VLAN Configuration Task List

- Configuring Private VLAN
- Configuring the association of private VLAN domains
- Configuring the L2 port of private VLAN to be the host port
- Configuring the L2 port of private VLAN to be the promiscuous port
- Modifying related fields of egress packets in private VLAN
- Displaying the configuration information of private VLAN

18.5 Private VLAN Configuration Tasks

The conditions for a private VLAN peer to take effect are listed below:

1. Having the primary VLAN
2. Having the secondary VLAN
3. Having the association between primary VLAN and secondary VLAN
4. Having the promiscuous port in primary VLAN

18.5.1 Configuring Private VLAN

Use the following commands to set VLAN to be a private VLAN.

Command	Purpose
vlan <i>vlan-id</i>	Enters the VLAN mode.
private-vlan {primary community isolated}	Configures the features of private VLAN.
no private-vlan {primary community isolated}	Deletes the features of private VLAN.
show vlan private-vlan	Displays the configuration of private VLAN.
exit	Exits from Vlan configuration mode.

18.5.2 Configuring the Association of Private VLAN Domains

Run the following commands to associate the primary VLAN and the secondary VLAN.

Command	Purpose
vlan <i>vlan-id</i>	Enters the primary VLAN configuration mode.
private-vlan association { <i>svlist</i> addsvlist removesvlist }	Sets the to-be-associated secondary VLAN.
no private-vlan association	Clears all associations between the current primary VLAN and all secondary VLANs.
exit	Exits the VLAN configuration mode.

18.5.3 Configuring the L2 Port of Private VLAN to Be the Host Port

Run the following commands to set the L2 port of private VLAN to be the host port:

Command	Purpose
Interface <i>interface</i>	Enters the interface configuration mode.
switchport mode private-vlan host	Sets the layer-2 port to be in host's port mode.
no switchport mode	Deletes the private VLAN mode configuration of L2 port.
switchport private-vlan host-association <i>p_vid</i> <i>s_vid</i>	Associates the L2 host port with private VLAN.
no switchport private-vlan host-association	Deletes the association between L2 host port and private VLAN.
exit	Exits from the interface configuration mode.

18.5.4 Configuring the L2 Port of Private VLAN to Be the Promiscuous Port

Run the following commands to set the L2 port of private VLAN to be the promiscuous port:

Command	Purpose
Interface <i>interface</i>	Enters the interface configuration mode.
switchport mode private-vlan promiscuous	Sets the layer-2 port to be in promiscuous port mode.
no switchport mode	Deletes the private VLAN mode configuration of L2 port.
switchport private-vlan mapping <i>p_vid</i> { <i>svlist</i> addsvlist remove svlist }	Associates the L2 promiscuous port with private VLAN.
no switchport private-vlan mapping	Deletes the association between L2 promiscuous port and private VLAN.
exit	Exits from the interface configuration mode.

18.5.5 Modifying Related Fields of Egress Packets in Private VLAN

Run the following commands to modify related fields of the egress packets in private VLAN:

Command	Purpose
Interface <i>interface</i>	Enters the interface configuration mode.
switchport private-vlan tag-pvid <i>vlan-id</i>	Sets the VLAN ID field in the tag of egress packet.
switchport private-vlan tag-pri <i>pri</i>	Sets the priority field in the tag of egress packet.
[no] switchport private-vlan untagged	Sets whether the egress packets have the tag or not.
exit	Exits from interface configuration mode.

18.5.6 Displaying the Configuration Information of Private VLAN

Run the following commands in global, interface or VLAN configuration mode to display the private VLAN configuration information of private VLAN and L2 port:

Command	Purpose
show vlan private-vlan	Displays the configuration of private VLAN.
show vlan private-vlan interface <i>interface</i>	Displays the configuration of the L2 port in the private VLAN.

18.6 Configuration Example

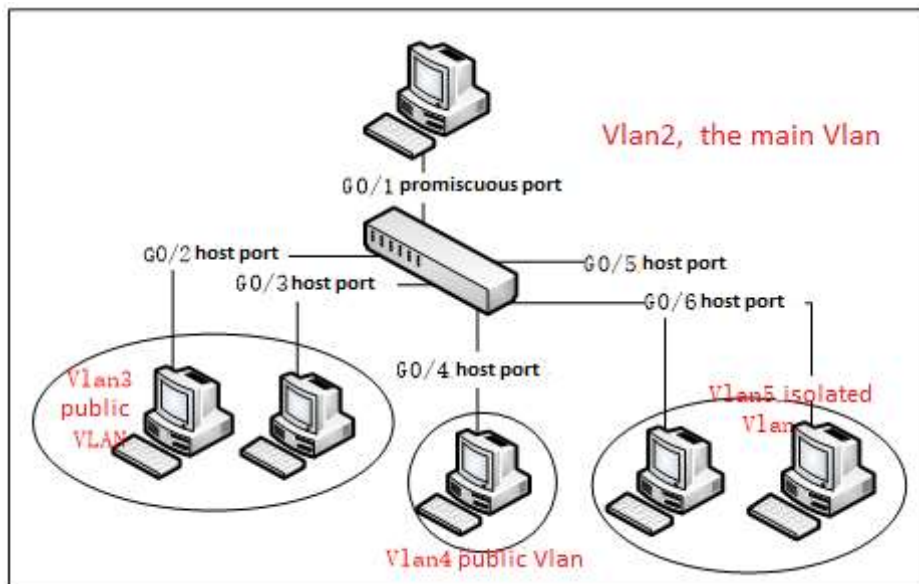

Figure 1: Typical Configuration of Private VLAN

As shown in figure 1, port G0/1 is the promiscuous port in primary VLAN 2 and ports G0/2-G0/6 are host ports, among which ports G0/2 and G0/3 are host ports (public ports) of Community VLAN 3, port G0/4 is that of Community VLAN 4, and ports G0/5 and G0/6 are host ports of Isolated VLAN 5. According to the definition of private VLAN, L2 communication can be conducted between promiscuous port

G0/1 and host ports of all sub-VLAN domains, so it is between host ports G0/2 and G0/3 of community VLAN 3, but they cannot conduct L2 communication with other host ports of secondary VLANs. L2 communication cannot go on between ports G0/5 and G0/6 in Isolated VLAN 5, but the two ports can conduct L2 communication with promiscuous port G0/1.

The commands requiring to be entered in a switch are shown below:

```
Switch_config#interface GigaEthernet0/1
Switch_config_g0/1#switchport mode private-vlan promiscuous
Switch_config_g0/1#switchport private-vlan mapping 2 3-5
Switch_config_g0/1#switchport pvid 2
```

```
Switch_config#interface GigaEthernet0/2
Switch_config_g0/2#switchport mode private-vlan host
Switch_config_g0/2#switchport private-vlan host-association 2 3
Switch_config_g0/2#switchport pvid 3
```

```
Switch_config#interface GigaEthernet0/3
Switch_config_g0/3#switchport mode private-vlan host
Switch_config_g0/3#switchport private-vlan host-association 2 3
Switch_config_g0/3#switchport pvid 3
```

```
Switch_config#interface GigaEthernet0/4
Switch_config_g0/4#switchport mode private-vlan host
Switch_config_g0/4#switchport private-vlan host-association 2 4
Switch_config_g0/4# switchport pvid 4
```

```
Switch_config#interface GigaEthernet0/5
Switch_config_g0/5#switchport mode private-vlan host
Switch_config_g0/5#switchport private-vlan host-association 2 5
Switch_config_g0/5#switchport pvid 5
```

```
Switch_config#interface GigaEthernet0/6
Switch_config_g0/5#switchport mode private-vlan host
Switch_config_g0/5#switchport private-vlan host-association 2 5
Switch_config_g0/5#switchport pvid 5
```

```
Switch_config#vlan 2
Switch_config_vlan2#private-vlan primary
Switch_config_vlan2#private-vlan association 3-5
```

```
Switch_config#vlan 3
```

Switch_config_vlan3#private-vlan community

Switch_config#vlan 4

Switch_config_vlan4#private-vlan community

Switch_config#vlan 5

Switch_config_vlan5#private-vlan isolated

Switch_config#show vlan private-vlan

<u>Primary..</u>	<u>Secondary..</u>	<u>Type.....</u>	<u>Ports.....</u>
2	3	community	g0/1, g0/2, g0/3
2	4	community	g0/1, g0/4
2	5	isolated	g0/1, g0/5, g0/6

Chapter 19. STP Configuration

19.1 Configuring STP

19.1.1 STP Introduction

The standard Spanning Tree Protocol (STP) is based on the IEEE 802.1D standard. A switch stack appears as a single spanning-tree node to the rest of the network, and all stack members use the same bridge ID.

Unless otherwise noted, the term switch refers to a standalone switch and to a switch stack.

The STP uses a spanning-tree algorithm to select one switch of a redundantly connected network as the root of the spanning tree. The algorithm calculates the best loop-free path through a switched Layer 2 network by assigning a role to each port based on the role of the port in the active topology.

STP is a Layer 2 link management protocol that provides path redundancy while preventing loops in the network. For a Layer 2 Ethernet network to function properly, only one active path can exist between any two stations. Multiple active paths among end stations cause loops in the network. If a loop exists in the network, end stations might receive duplicate messages. Switches might also learn end-station MAC addresses on multiple Layer 2 interfaces. These conditions result in an unstable network. Spanning-tree operation is transparent to end stations, which cannot detect whether they are connected to a single LAN segment or a switched LAN of multiple segments.

The STP uses a spanning-tree algorithm to select one switch of a redundantly connected network as the root of the spanning tree. The algorithm calculates the best loop-free path through a switched Layer 2 network by assigning a role to each port based on the role of the port in the active topology:

The standard Spanning-Tree Protocol (STP) is defined in IEEE 802.1D. It simplifies the LAN topology comprising several bridges to a sole spinning tree, preventing network loop from occurring and ensuring stable work of the network.

The algorithm of STP and its protocol configure the random bridging LAN to an active topology with simple connections. In the active topology, some bridging ports can forward frames; some ports are in the congestion state and cannot transmit frames. Ports in the congestion state may be concluded in the active topology.

When the device is ineffective, added to or removed from the network, the ports may be changed to the transmitting state.

In the STP topology, a bridge can be viewed as root. For every LAN section, a bridging port will forward data from the network section to the root. The port is viewed as the designated port of the network section. The bridge where the port is located is viewed as the designated bridge of the LAN. The root is the designated bridge of all network sections that the root connects. In ports of each bridge, the port which is nearest to the root is the root port of the bridge. Only the root port and the designated port (if available) is in the transmitting state. Ports of another type are not shut down but they are not the root port or the designated port. We call these ports are standby ports.

The following parameters decide the structure of the stabilized active topology:

- (1) Identifier of each bridge

- (2) Path cost of each port
- (3) Port identifier for each port of the bridge

The bridge with highest priority (the identifier value is the smallest) is selected as the root. Ports of each bridge have the attribute **Root Path Cost**, that is, the minimum of path cost summation of all ports from the root to the bridge. The designated port of each network segment refers to the port connecting to the network segment and having the minimum path cost.

When two ports on a switch are part of a loop, the spanning-tree port priority and path cost settings control which port is put in the forwarding state and which is put in the blocking state. The spanning-tree port priority value represents the location of a port in the network topology and how well it is located to pass traffic. The path cost value represents the media speed.

Our switch standard supports two modes of spanning tree protocol 802.1D STP and 802.1w RSTP. Some models of the switch support distributing STP mode according to VLAN and MSTP spanning tree protocol. For more details, please refer to ‘STP Mode and Model Table’ in chapter 2.

This chapter describes how to configure the standard spanning tree protocol that switch supports.



802.1D STP and 802.1w RSTP are abbreviated to SSTP and RSTP in this article. SSTP means Single Spanning-tree.

19.1.2 SSTP Configuration Task List

- Selecting STP Mode
 - Disabling/Enabling STP
 - Configuring the Switch Priority
 - Configuring the Hello Time
 - Configuring the Max-Age Time
 - Configuring the Forward Delay Time
 - Configuring Port Priority
 - Configuring Path Cost
 - Configuring the Auto-Designated port
 - Monitoring STP Status

19.1.3 SSTP Configuration Task

19.1.3.1 Selecting STP Mode

Run the following command to configure the STP mode:

Command	Purpose
spanning-tree mode {sstp rstp}	Selects the STP configuration.

19.1.3.2 Disabling/Enabling STP

Spanning tree is enabled by default. Disable spanning tree only if you are sure there are no loops in the

network topology.

Follow these steps to disable spanning-tree:

Command	Purpose
no spanning-tree	Disables STP.

To enable spanning-tree, use the following command:

Command	Purpose
spanning-tree	Enables default mode STP (SSTP).
spanning-tree mode {sstp rstp}	Enables a certain mode STP.

19.1.3.3 Configuring the Switch Priority

You can configure the switch priority and make it more likely that a standalone switch or a switch in the stack will be chosen as the root switch.

Follow these steps to configure the switch priority:

Command	Purpose
spanning-tree sstp priority <i>value</i>	Modifies sstp priority value.
no spanning-tree sstp priority	Returns sstp priority to default value (32768).

19.1.3.4 Configuring the Hello Time

User can configure the interval between STP data units sent by the root switch through changing the hello time.

Use the following command to configure Hello Time of SSTP:

Command	Purpose
spanning-tree sstp hello-time <i>value</i>	Configures sstp Hello Time.
no spanning-tree sstp hello-time	Returns sstp Hello Time to default value (4s).

19.1.3.5 Configuring the Max-Age Time

Use the sstp max age to configure the number of seconds a switch waits without receiving spanning-tree configuration messages before attempting a reconfiguration.

Follow these steps to configure the maximum-aging time:

Command	Purpose
spanning-tree sstp max-age <i>value</i>	Configures the sstp max-age time.
no spanning-tree sstp max-age	Returns the max-age time to default value (20s).

19.1.3.6 Configuring the Forward Delay Time

Configure sstp forward delay to determine the number of seconds an interface waits before changing from its spanning-tree learning and listening states to the forwarding state.

Use the following command to configure sstp forward delay:

Command	Purpose
<code>spanning-tree sstpforward-time</code>	Configures sstp Forward time.
<code>no spanning-tree sstp forward-time</code>	Returns forward time to default value (15s).

19.1.3.7 Configuring the Port Priority

If a loop occurs, spanning tree uses the port priority when selecting an interface to put into the forwarding state. You can assign higher priority values (lower numerical values) to interfaces that you want selected first and lower priority values (higher numerical values) that you want selected last. If all interfaces have the same priority value, spanning tree puts the interface with the lowest interface number in the forwarding state and blocks the other interfaces.

Follow these steps to configure the port priority of an interface:

Command	Purpose
<code>spanning-tree port-priority value</code>	Configures the port priority for an interface.
<code>spanning-tree sstp port-priorityvalue</code>	Modifies sstp port priority.
<code>no spanning-tree sstp port-priority</code>	Returns port priority to default value (128).

19.1.3.8 Configuring the Path Cost

Follow these steps to configure the cost of an interface:

Command	Purpose
<code>spanning-tree cost value</code>	Configures the cost for an interface.
<code>spanning-tree sstp costvalue</code>	Modifies sstp path cost.
<code>no spanning-tree sstp cost</code>	Returns path cost to default value.

19.1.3.9 Configuring Auto-Designated Port

The auto-designated port is a special function of the switch. The function allows line card to automatically send BPDU to the auto-designated port, reducing the load of the MSU.

The auto-designated port function is effective in STP mode.

In global configuration mode, run the following commands to configure the auto-designated port function of switch:

Command	Purpose
<code>spanning-tree designated-auto</code>	Enables the auto-designated port

	function.
no spanning-tree designated-auto	Disables the auto-designated port function.

19.1.3.10 Monitoring STP State

To monitor the STP configuration and state, use the following command in management mode:

Command	Purpose
show spanning-tree	Displays spanning-tree information on active interfaces only.
show spanning-tree detail	Displays a detailed summary of interface information.
show spanning-tree interface	Displays spanning-tree information for the specified interface.

19.1.4 Configuring VLAN STP

19.1.4.1 Overview

In SSTP mode, the whole network has only one STP entity. The state of the switch port in the STP decides its state in all VLANs. In the case that multiple VLANs exist in the network, the separation of the single STP and the network topology may cause communication congestion in some parts of network.

Our switches run independent SSTP on a certain number of PurposeVLANs, ensuring that the port has different state in different VLANs and that the load balance is realized between VLANs.

Note that the switch can run the independent STP in up to 30 VLANs. Other VLAN topologies are not controlled by the STP.

19.1.4.2 VLAN STP Configuration Task

In global configuration mode, run the following commands to configure SSTP attributes in VLAN:

Command	Purpose
spanning-tree mode pvst	Starts the VLAN-based STP distribution mode.
spanning-tree vlan <i>vlan-list</i>	Distributes the STP case for the designated VLAN. vlan-list: the list of VLAN The switch distributes STP case for up to 30 VLANs.
no spanning-tree vlan <i>vlan-list</i>	Deletes the STP case in the designated VLA.
spanning-tree vlan <i>vlan-list</i> priority <i>value</i>	Configures the priority for the STP in the designated VLAN.

no spanning-tree <i>vlan-list</i> priority	Resumes the STP priority in the VLAN to the default configuration.
spanning-tree vlan <i>vlan-list</i> forward-time <i>value</i>	Configures Forward Delay for the designated VLAN.
no spanning-tree vlan <i>vlan-list</i> forward-time	Resumes Forward Delay of the designated VLAN to the default configuration.
spanning-tree vlan <i>vlan-list</i> max-age <i>value</i>	Configures Max-age for the designated VLAN.
no spanning-tree vlan <i>vlan-list</i> max-age	Resumes Max-age of the designated VLAN to the default configuration.
spanning-tree vlan <i>vlan-list</i> hello-time <i>value</i>	Configures HELLO-TIME for the designated VLAN.
no spanning-tree vlan <i>vlan-list</i> hello-time	Resumes HELLO-TIME of the designated VLAN to the default configuration.

In port configuration mode, run the following command to configure attributes of the port:

Command	Purpose
spanning-tree vlan <i>vlan-list</i> cost	Configures the path cost of the designated VLAN for the port.
no spanning-tree vlan <i>vlan-list</i> cost	Resumes the default path cost of the designated VLAN for the port.
spanning-tree vlan <i>vlan-list</i> port-priority	Configures the port priority in the VLAN.
no spanning-tree vlan <i>vlan-list</i> port-priority	Resumes the default port priority in the VLAN.

In monitor or configuration mode, run the following command to check the STP state in the specified VLAN:

Command	Purpose
show spanning-tree vlan <i>vlan-list</i>	Check the STP state in the VLAN.

19.1.5 RSTP Configuration Task List

- Enabling/Disabling Switch RSTP
- Configuring the Switch Priority
- Configuring the Forward Delay Time
- Configuring the Hello time
- Configuring the Max-Age
- Configuring the Path Cost

- Configuring the Port Priority
- Enabling Protocol Conversation Check

19.1.6 RSTP Configuration Task

19.1.6.1 Enabling/Disabling Switch RSTP

Follow these configurations in the global configuration mode:

Command	Purpose
spanning-tree mode rstp	Enables RSTP
no spanning-tree mode	Returns STP to default mode (SSTP)

19.1.6.2 Configuring the Switch Priority

You can configure the switch priority and make it more likely that a standalone switch or a switch in the stack will be chosen as the root switch.

Follow these steps to configure the switch priority:

Follow these configurations in the global configuration mode:

Command	Purpose
spanning-tree rstp priority <i>value</i>	Modifies rstp priority value.
no spanning-tree rstp priority	Returns rstp priority to default value.



If the priority of all bridges in the whole switch network uses the same value, then the bridge with the least MAC address will be chosen as the root bridge. In the situation when the RSTP protocol is enabled, if the bridge priority value is modified, it will cause the recalculation of spanning tree.

The bridge priority is configured to 32768 by default.

19.1.6.3 Configuring the Forward Delay Time

Link failures may cause network to recalculate the spanning tree structure. But the latest configuration message can no be conveyed to the whole network. If the newly selected root port and the specified port immediately start forwarding data, this may cause temporary path loop. Therefore the protocol adopts a kind of state migration mechanism. There is an intermediate state before root port and the specified port starting data forwarding, after the intermediate state passing the Forward Delay Time, the forward state begins. This delay time ensures the newly configured message has been conveyed to the whole network. The Forward Delay characteristic of the bridge is related to the network diameter of the switch network. Generally, the grater the network diameter, the longer the Forward Delay Time should be configured.

Follow these configurations in the global configuration mode:

Command	Purpose
spanning-tree rstp forward-time <i>value</i>	Configures Forward Delay
no spanning-tree rstp forward-time	Returns Forward Delay Time to default

	value (15s).
--	--------------



If you configure the Forward Delay Time to a relatively small value, it may leads to a temporary verbose path. If you configure the Forward Delay Time to a relatively big value, the system may not resume connecting for a long time. We recommend user to use the default value.

The Forward Delay Time of the bridge is 15 seconds.

19.1.6.4 Configuring the Hello Time

The proper hello time value can ensure that the bridge detect link failures in the network without occupying too much network resources.

Follow these configurations in the global configuration mode:

Command	Purpose
spanning-tree rstp hello-time <i>value</i>	Configures Hello Time
no spanning-tree rstp hello-time	Returns Hello Time to default value.



We recommend user to use the default value.

The default Hello Time is 4 seconds.

19.1.6.5 Configuring the Max-Age

The ma-age is the number of seconds a switch waits without receiving spanning-tree configuration messages before attempting a reconfiguration.

Follow these configurations in the global configuration mode:

Command	Purpose
spanning-tree rstp max-age <i>value</i>	Configures the max-age value.
no spanning-tree rstp max-age	Returns the max-age time to default value (20s).

We recommend user to use the default value.



if you configure the Max Age to a relatively small value, then the calculation of the spanning tree will be relatively frequent, and the system may regard the network block as link failure. If you configure the Max Age to a relatively big value, then the link status will go unnoticed in time.

The Max Age of bridge is 20 seconds by default.

19.1.6.6 Configuring the Path Cost

The spanning-tree path cost default value is derived from the media speed of an interface. If a loop occurs, spanning tree uses cost when selecting an interface to put in the forwarding state. You can assign lower cost

values to interfaces that you want selected first and higher cost values to interfaces that you want selected last. If all interfaces have the same cost value, spanning tree puts the interface with the lowest interface number in the forwarding state and blocks the other interfaces.

Beginning in interface configuration mode, follow these steps to configure the cost of an interface:

Command	Purpose
<code>spanning-tree rstp costvalue</code>	Configures the cost for an interface.
<code>no spanning-tree rstp cost</code>	Returns path cost to default value.



The modification of the priority of the Ethernet port will arise the recalculation of the spanning tree. We recommend user to use the default value and let RSTP protocol calculate the path cost of the current Ethernet interface.

When the port speed is 10Mbps, the path cost of the Ethernet interface is 2000000.
When the port speed is 100Mbps, the path cost of the Ethernet interface is 200000.

19.1.6.7 Configuring the Port Priority

If a loop occurs, spanning tree uses the port priority when selecting an interface to put into the forwarding state. You can assign higher priority values (lower numerical values) to interfaces that you want selected first, and lower priority values (higher numerical values) that you want selected last. If all interfaces have the same priority value, spanning tree puts the interface with the lowest interface number in the forwarding state and blocks the other interfaces.

Follow these configurations in the interface configuration mode:

Command	Purpose
<code>spanning-tree rstp port-priorityvalue</code>	Configures the port priority for an interface.
<code>no spanning-tree rstp port-priority</code>	Returns the port priority to the default value.



The modification of the priority of the Ethernet interface will arise the recalculation of the spanning tree.

The default Ethernet interface priority is 128.

19.2 Configuring MTSP

19.2.1 MSTP Overview

19.2.1.1 Introduction

Multiple Spanning Tree Protocol (MSTP) is used to create simple complete topology in the bridging LAN. MSTP can be compatible with the earlier Spanning Tree Protocol (STP) and Rapid Spanning Tree Protocol (RSTP).

Both STP and RSTP only can create sole STP topology. All VLAN messages are forwarded through the only STP. STP converges too slow, so RSTP ensures a rapid and stable network topology through the handshake mechanism.

MSTP inherits the rapid handshake mechanism of RSTP. At the same time, MST allows different VLAN to be distributed to different STPs, creating multiple topologies in the network. In networks created by MSTP, frames of different VLANs can be forwarded through different paths, realizing the load balance of the VLAN data.

Different from the mechanism that VLAN distributes STP, MSTP allows multiple VLANs to be distributed to one STP topology, effectively reducing STPs required to support lots of VLANs.

19.2.1.2 MST Domain

In MSTP, the relationship between VLAN and STP is described through the MSTP configuration table. MSTP configuration table, configuration name and configuration edit number makes up of the MST configuration identifier.

In the network, interconnected bridges with same MST configuration identifier are considered in the same MST region. Bridges in the same MST region always have the same VLAN configuration, ensuring VLAN frames are sent in the MST region.

19.2.1.3 IST, CST, CIST and MSTI

Figure 2.1 shows an MSTP network, including three MST regions and a switch running 802.1D STP.

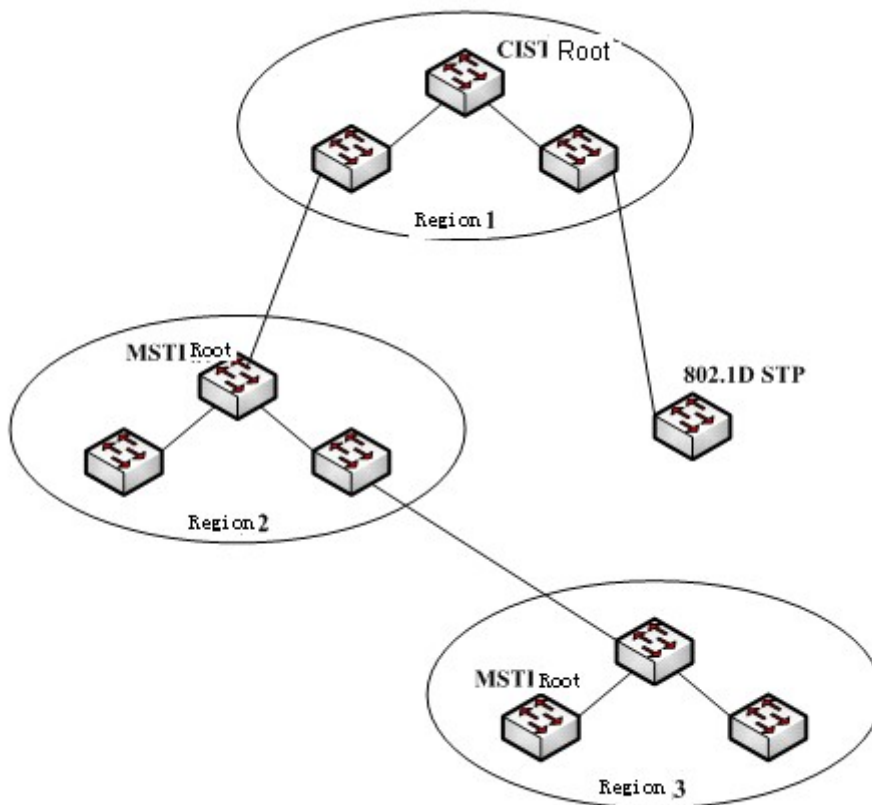

Figure 2.1 MSTP topology

1. CIST

Common and Internal Spanning Tree (CIST) means the spanning tree comprised by all single switches and interconnected LAN. These switches may belong to different MST regions. They may be switches running traditional STP or RSTP. Switches running STP or RSTP in the MST regions are considered to be in their own regions.

After the network topology is stable, the whole CIST chooses a CIST root bridge. An internal CIST root bridge will be selected in each region, which is the shortest path from the heart of the region to CIST root.

2. CST

If each MST region is viewed as a single switch, Common Spanning Tree (CST) is the spanning tree connecting all “single switches”. As shown in Figure 2.1, region 1, 2 and 3 and STP switches make up of the network CST.

3. IST

Internal Spanning Tree (IST) refers to part of CIST that is in an MST region, that is, IST and CST make up of the CIST.

4. MSTI

The MSTP protocol allows different VLANs to be distributed to different spanning trees. Multiple spanning tree instances are then created. Normally, No.0 spanning tree instance refers to CIST, which can be expanded to the whole network. Every spanning tree instance starting from No.1 is in a certain region. Each spanning tree instance can be distributed with multiple VLANs. In original state, all VLANs are distributed in CIST.

MSTI in the MST region is independent. They can choose different switches as their own roots.

19.2.1.4 Port Role

Ports in MSTP can function as different roles, similar to ports in RSTP.

1. Root port

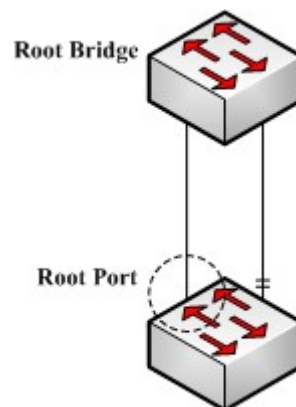

Figure 2.2 Root port

Root port stands for the path between the current switch and the root bridge, which has minimum root path cost.

2. Alternate port

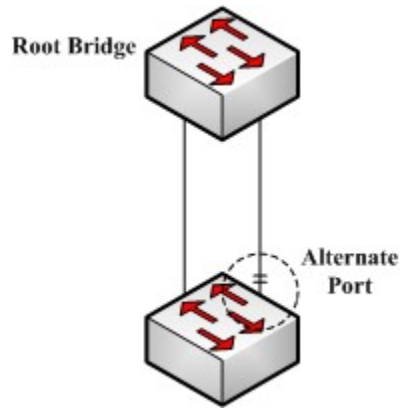

Figure 2.3 Alternate port

The alternate port is a backup path between the current switch and the root bridge. When the connection of root port is out of effect, the alternate port can promptly turn into a new root port without work interruption.

3. Designated port

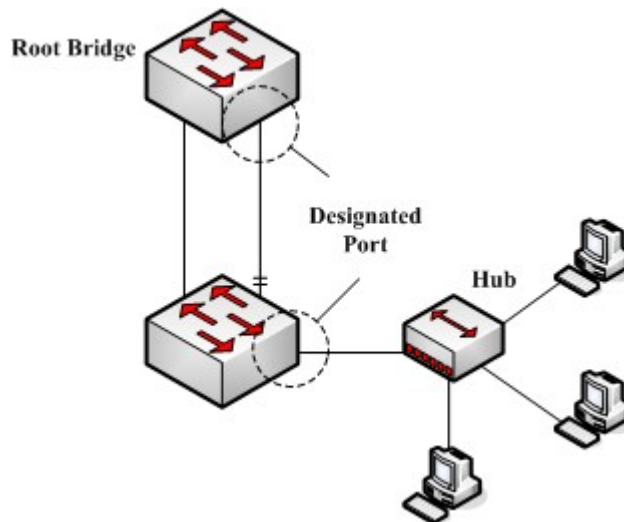

Figure 2.4 Designated port

The designated port can connect switches or LAN in the next region. It is the path between the current LAN and root bridge.

4. Backup port

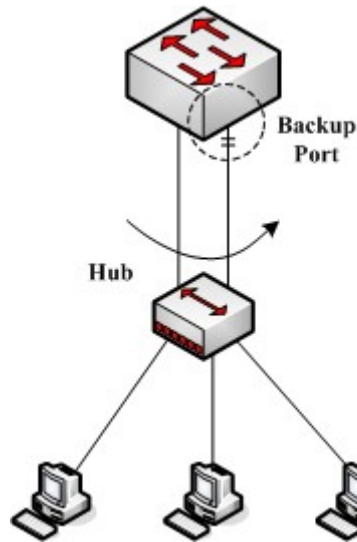

Figure 2.5 Backup port

When two switch ports directly connect or both connect to the same LAN, the port with lower priority is to be the backup port, the other port is to be the designated port. If the designated port breaks down, the backup port becomes the designated port to continue working.

5. Master port

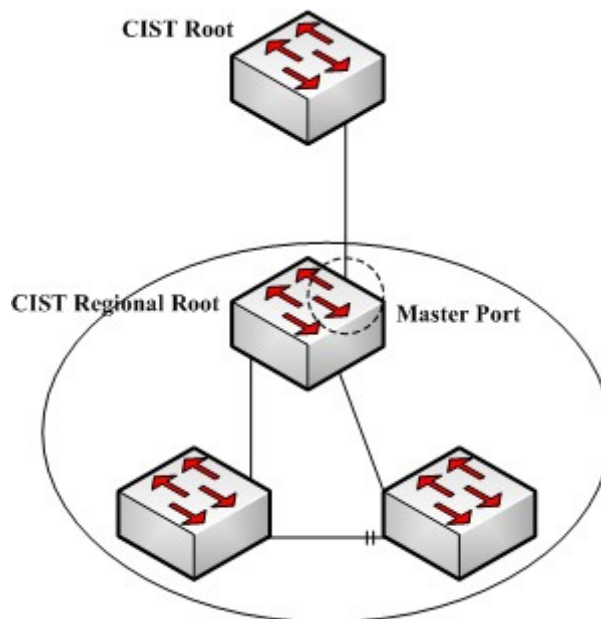

Figure 2.6 Master port

The Master port is the shortest path between MST region and CIST root bridge. Master port is the root port of the root bridge in the CIST region.

6. Boundary port

The concept of boundary port in CIST is a little different from that in each MSTI. In MSTI, the role of the boundary port means that the spanning tree instance does not expand on the port.

7. Edge port

In the RSTP protocol or MSTP protocol, edge port means the port directly connecting the network host. These ports can directly enter the forwarding state without causing any loop in the network.

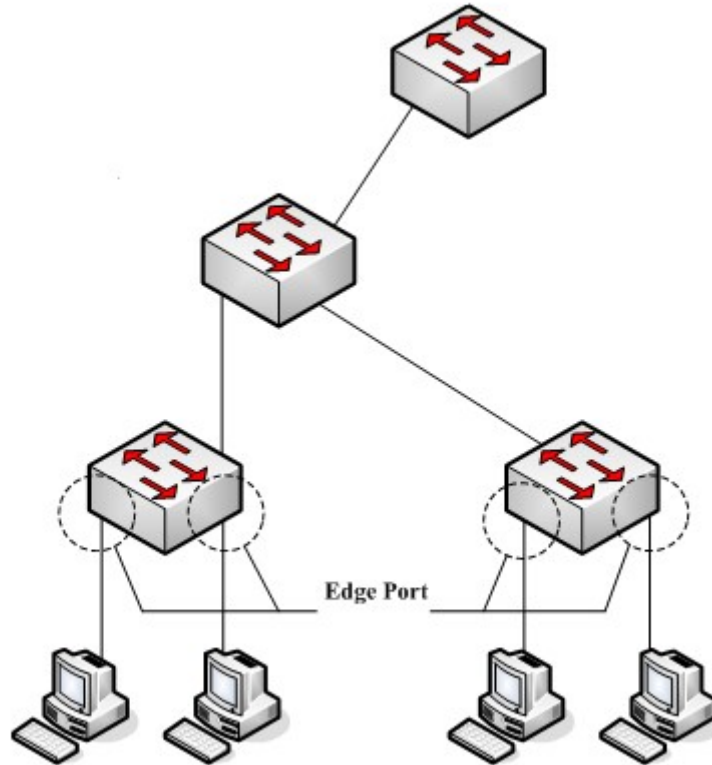

Figure 2.7 Edge port

In original state, MSTP and RSTP do not take all ports as edge ports, ensuring the network topology can be rapidly created. In this case, if a port receives BPDU from other switches, the port is resumed from the edge state to the normal state. If the port receives 802.1D STP BPDU, the port has to wait for double Forward Delay time and then enter the forwarding state.

19.2.1.5 MSTP BPDU

Similar to STP and RSTP, switches running MSTP can communicate with each other through Bridge Protocol Data Unit (BPDU). All configuration information about the CIST and MSTI can be carried by BPDU. Table 2.1 and Table 2.2 list the structure of BPDU used by the MSTP.

Table 2.1 MSTP BPDU

Field Name	Byte Number
Protocol Identifier	1 – 2
Protocol Version Identifier	3
BPDU Type	4
CIST Flags	5

CIST Root Identifier	6 – 13
CIST External Root Path Cost	14 – 17
CIST Regional Root Identifier	18 – 25
CIST Port Identifier	26 – 27
Message Age	28 – 29
Max Age	30 – 31
Hello Time	32 – 33
Forward Delay	34 – 35
Version 1 Length	36
Version 3 Length	37 – 38
Format Selector	39
Configuration Name	40 – 71
Revision	72 – 73
Configuration Digest	74 – 89
CIST Internal Root Path Cost	90 – 93
CIST Bridge Identifier	94 – 101
CIST Remaining Hops	102
MSTI Configuration Messages	103 ~

Table 2.2 MST configuration information

Field Name	Byte Number
MSTI FLAGS	1
MSTI Regional Root Identifier	2 – 9
MSTI Internal Root Path Cost	10 – 13
MSTI Bridge Priority	14
MSTI Port Priority	15
MSTI Remaining Hops	16

19.2.1.6 Stable State

The MSTP switch performs calculation and compares operations according to the received BPDU, and finally ensures that:

- (1) One switch is selected as the CIST root of the whole network.
- (2) Each switch and LAN segment can decide the minimum cost path to the CIST root, ensuring a complete connection and prevent loops.
- (3) Each region has a switch as the CIST regional root. The switch has the minimum cost path to the CIST

root.

- (4) Each MSTI can independently choose a switch as the MSTI regional root.
- (5) Each switch in the region and the LAN segment can decide the minimum cost path to the MSTI root.
- (6) The root port of CIST provides the minimum-cost path between the CIST regional root and the CIST root.
- (7) The designated port of the CIST provided its LAN with the minimum-cost path to the CIST root.
- (8) The Alternate port and the Backup port provides connection when the switch, port or the LAN does not work or is removed.
- (9) The MSTI root port provides the minimum cost path to the MSTI regional root.
- (10) The designated port of MSTI provides the minimum cost path to the MSTI regional root.
- (11) A master port provides the connection between the region and the CIST root. In the region, the CIST root port of the CIST regional root functions as the master port of all MSTI in the region.

19.2.1.7 Hop Count

Different from STP and RSTP, the MSTP protocol does not use Message Age and Max Age in the BPDU configuration message to calculate the network topology. MSTP uses Hop Count to calculate the network topology.

To prevent information from looping, MSTP relates the transmitted information to the attribute of hop count in each spanning tree. The attribute of hop count for BPDU is designated by the CIST regional root or the MSTI regional root and reduced in each receiving port. If the hop count becomes 0 in the port, the information will be dropped and then the port turns to be a designated port.

19.2.1.8 STP Compatibility

MSTP allows the switch to work with the traditional STP switch through protocol conversion mechanism. If one port of the switch receives the STP configuration message, the port then only transmits the STP message. At the same time, the port that receives the STP information is then considered as a boundary port.

When a port is in the STP-compatible state, the port will not automatically resume to the MSTP state even if the port does not receive the STP message any more. In



this case, you can run `spanning-tree mstp migration-check` to clear the STP message that the port learned, and make the port to return to the MSTP state.

The switch that runs the RSTP protocol can identify and handle the MSTP message. Therefore, the MSTP switch does not require protocol conversion when it works with the RSTP switch.

19.2.2 MSTP Configuration Task List

- Default MSTP configuration
- Enabling and disabling MSTP
- Configuring MSTP region
- Configuring network root

- Configuring secondary root
- Configuring bridge priority
- Configuring time parameters of STP
- Configuring network diameter
- Configuring maximum hop count
- Configuring port priority
- Configuring path cost for port
- Configuring port connection type
- Activating MST-compatible mode

19.2.2.1 Activating MST-Compatible Mode

The MSTP protocol that our switches support is based on IEEE 802.1s. In order to be compatible with other MSTPs, especially MSTP that the Cisco switches support, the MSTP protocol can work in MST-compatible mode. Switches running in MSTP-compatible mode can identify the message structure of other MSTPs, check the contained MST regional identifier and establish the MST region.

The MST-compatible mode and the STP-compatible mode are based on MSTP protocol conversion mechanism. If one port of the switch receives BPDU in compatible mode, the port automatically changes to the mode and sends BPDU in compatible mode. To resume the port to standard MST mode, you can run **spanning-tree mstp migration-check**.

In global configuration mode, run the following commands to activate or disable the MST-compatible mode:

Command	Purpose
spanning-tree mstp mst-compatible	Activates the MST-compatible mode for the switch.
no spanning-tree mstp mst-compatible	Disables the MST-compatible mode for the switch.

The main function of the compatible mode is to create the MST area for switches and other MSTP-running switches. In actual networking, make sure that the switch has the same configuration name and the same edit number. It is recommended to configure switches running other MSTP protocols to the CIST root, ensuring that the switch enters the compatible mode by receiving message.



If the MST-compatible mode is not activated, the switch will not resolve the whole BPDU-compatible content and take the content as the common RSTP BPDU. In this way, the switch cannot be in the same area with the MST-compatible switch that it connects.

A port in compatible mode cannot automatically resumes to send standard MST BPDU even if the compatible mode is shut down in global configuration mode. In this case, run migration-check.

- Restart the protocol conversion check.
- Check the MSTP message.

19.2.3 MSTP Configuration Task

19.2.3.1 Default MSTP Configuration

Attribute	Default Settings
STP mode	SSTP (PVST, RSTP and MSTP is not started)
Area name	Character string of MAC address
Area edit level	0
MST configuration list	All VLANs are mapped in CIST (MST00).
Spanning-tree priority (CIST and all MSTI)	32768
Spanning-tree port priority (CIST and all MSTI)	128
Path cost of the spanning-tree port (CIST and all MSTI)	1000 Mbps: 20000 100 Mbps: 200000 10 Mbps: 2000000
Hello Time	2 seconds
Forward Delay	15 seconds
Maximum-aging Time	20 seconds
Maximum hop count	20

19.2.3.2 Enabling and Disabling MSTP

The STP protocol can be started in PVST or SSTP mode by default. You can stop it running when the spanning-tree is not required.

Run the following command to set the STP to the MSTP mode:

Command	Purpose
spanning-tree	Enables STP in default mode.
spanning-tree mode mstp	Enables MSTP.

Run the following command to disable STP:

Command	Purpose
no spanning-tree	Disables the STP.

19.2.3.3 Configuring MST Area

The MST area where the switch resides is decided by three attributes: configuration name, edit number, the mapping relation between VLAN and MSTI. You can configure them through area configuration commands. Note that the change of any of the three attributes will cause the change of the area where the switch resides. In original state, the MST configuration name is the character string of the MAC address of the switch. The edit number is 0 and all VLANs are mapped in the CIST (MST00). Because different switch has different MAC

address, switches that run MSTP are in different areas in original state. You can run `spanning-tree mstp instance instance-id vlan vlan-list` to create a new MSTI and map the designated VLAN to it. If the MSTI is deleted, all these VLANs are mapped to the CIST again.

Run the following command to set the MST area information:

Command	Purpose
<code>spanning-tree mstp namestring</code>	Configures the MST configuration name. string means the character string of the configuration name. It contains up to 32 characters, capital sensitive. The default value is the character string of the MAC address.
<code>no spanning-tree mstp name</code>	Sets the MST configuration name to the default value.
<code>spanning-tree mstp revisionvalue</code>	Sets the MST edit number. value represents the edit number, ranging from 0 to 65535. The default value is 0.
<code>no spanning-tree mstp revision</code>	Sets the MST edit number to the default value.
<code>spanning-tree mstp instanceinstance-id vlanvlan-list</code>	Maps VLAN to MSTI. instance-id represents the instance number of the spanning tree, meaning an MSTI. It ranges from 1 to 15. vlan-list means the VLAN list that is mapped to the spanning tree. It ranges from 1 to 4094. instance-id is an independent value representing a spanning tree instance. vlan-list can represent a group of VLANs, such as "1,2,3", "1-5" and "1,2,5-10".
<code>no spanning-tree mstp instanceinstance-id</code>	Cancels the VLAN mapping of MSTI and disables the spanning tree instance. instance-id represents the instance number of the spanning tree, meaning an MSTI. It ranges from 1 to 15.

Run the following command to check the configuration of the MSTP area:

Command	Purpose
<code>show spanning-tree mstp region</code>	Displays the configuration of the MSTP area.

19.2.3.4 Configuring Network Root

In MSTP, each spanning tree instance has a bridge ID, containing the priority value and MAC address of the switch. During the establishment of spanning tree topology, the switch with comparatively small bridge ID is

selected as the network root.

MSTP can set the switch to the network switch through configuration. You can run the command **Spanning-tree mstpSpanning-tree mstpinstance-idrootroot** to modify the priority value of the switch in a spanning tree instance from the default value to a sufficiently small value, ensuring the switch turns to be the root in the spanning tree instance.

In general, after the previous command is executed, the protocol automatically check the bridge ID of the current network root and then sets the priority field of the bridge ID to **24576** when the value **24576** ensures that the current switch becomes the root of the spanning tree.

If the network root's priority value is smaller than the value **24576**, MSTP automatically sets the spanning tree's priority of the current bridge to a value that is 4096 smaller than the priority value of the root. Note that the number **4096** is a step length of network priority value.

When setting the root, you can run the **diameter** subcommand to the network diameter of the spanning tree network. The keyword is effective only when the spanning tree instance ID is 0. After the network diameter is set, MSTP automatically calculates proper STP time parameters to ensure the stability of network convergence. Time parameters include Hello Time, Forward Delay and Maximum Age. The subcommand Hello-time can be used to set a new hello time to replace the default settings.

Run the following command to set the switch to the network root:

Command	Purpose
spanning-tree mstpinstance-idroot primary [diameternet-diameter [hello-timesecods]]	Sets the switch to the root in the designated spanning tree instance. instance-id represents the number of the spanning tree instance, ranging from 0 to 15. net-diameter represents the network diameter, which is an optional parameter. It is effective when instance-id is 0. It ranges from 2 to 7. seconds represents the unit of the hello time, ranging from 1 to 10.
no spanning-tree mstpinstance-idroot	Cancels the root configuration of the switch in the spanning tree. instance-id means the number of the spanning tree instance, ranging from 0 to 15.

Run the following command to check the MSTP message:

Command	Purpose
show spanning-tree mstp [instanceinstance-id]	Checks the MSTP message.

19.2.3.5 Configuring Secondary Root

After the network root is configured, you can run **spanning-tree mstpinstance-idroot secondary** to set one

or multiple switches to the secondary roots or the backup roots. If the root does not function for certain reasons, the secondary roots will become the network root.

Different from the primary root configuration, after the command to configure the primary root is run, MSTP sets the spanning tree priority of the switch to **28672**. In the case that the priority value of other switches is the default value **32768**, the current switch can be the secondary root.

When configuring the secondary root, you can run the subcommands **diameter** and **hello-time** to update the STP time parameters. When the secondary root becomes the primary root and starts working, all these parameters starts functioning.

Run the following command to set the switch to the secondary root of the network:

Command	Purpose
<pre>spanning-tree mstpinstance-idroot secondary [diameternet-diameter [hello-timesecods]]</pre>	<p>Sets the switch to the secondary root in the designated spanning tree instance.</p> <p>instance-id represents the number of the spanning tree instance, ranging from 0 to 15.</p> <p>net-diameter represents the network diameter, which is an optional parameter. It is effective when instance-id is 0. It ranges from 2 to 7.</p> <p>seconds represents the unit of the hello time, ranging from 1 to 10.</p>
<pre>no spanning-tree mstpinstance-idroot</pre>	<p> Cancels the root configuration of the switch in the spanning tree.</p> <p>instance-id means the number of the spanning tree instance, ranging from 0 to 15.</p>

Run the following command to check the MSTP message:

Command	Purpose
<pre>show spanning-tree mstp [instanceinstance-id]</pre>	<p>Checks the message about the MST instance.</p>

19.2.3.6 Configuring Bridge Priority

In some cases, you can directly set the switch to the network root by configuring the bridge priority. It means that you can set the switch to the network root without running the subcommand **root**. The priority value of the switch is independent in each spanning tree instance. Therefore, the priority of the switch can be set independently.

Run the following command to configure the priority of the spanning tree:

Command	Purpose
<pre>spanning-tree mstpinstance-idpriorityvalue</pre>	<p>Sets the priority of the switch.</p> <p>instance-id represents the number of the spanning tree instance, ranging from 0 to 15.</p>

	<p>value represents the priority of the bridge. It can be one of the following values: 0, 4096, 8192, 12288, 16384, 20480, 24576, 28672, 32768, 36864, 40960, 45056, 49152, 53248, 57344, 61440</p>
no spanning-tree mstpinstance-idpriority	<p>Resumes the bridge priority of the switch to the default value.</p> <p>instance-id means the number of the spanning tree instance, ranging from 0 to 15.</p>

19.2.3.7 Configuring STP Time Parameters

The following are STP time parameters:

- Hello Time:

The interval to send the configuration message to the designated port when the switch functions as the network root.

- Forward Delay:

Time that the port needs when it changes from the **Blocking** state to the **learning** state and to the **forwarding** state in STP mode.

- Max Age:

The maximum live period of the configuration information about the spanning tree.

To reduce the shock of the network topology, the following requirements for the time parameters must be satisfied:

- $2 \times (\text{fwd_delay} - 1.0) \geq \text{max_age}$
- $\text{max_age} \geq (\text{hello_time} + 1) \times 2$

Command	Purpose
spanning-tree mstp hello-timesseconds	Sets the parameter Hello Time. The parameter seconds is the unit of Hello Time, ranging from 1 to 10 seconds. Its default value is two seconds.
no spanning-tree mstp hello-time	Resumes Hello Time to the default value.
spanning-tree mstp forward-timesseconds	Sets the parameter Forward Delay. The parameter seconds is the unit of Forward Delay, ranging from 4 to 30 seconds. Its default value is 15 seconds.
no spanning-tree mstp forward-time	Resumes Forward Delay to the default value.
spanning-tree mstp max-agesseconds	Sets the parameter Max Age. The parameter seconds is the unit of Max Age,

	ranging from 6 to 40 seconds. Its default value is 20 seconds.
no spanning-tree mstp max-age	Resumes Max Age to the default value.

It is recommended to modify STP time parameters by setting root or network diameter, which ensures correct modification of time parameters.

The newly-set time parameters are valid even if they do not comply with the previous formula's requirements. Pay attention to the notification on the console when you perform configuration.

19.2.3.8 Configuring Network Diameter

Network diameter stands for the maximum number of switches between two hosts in the network, representing the scale of the network.

You can set the MSTP network diameter by running the command **spanning-tree mstp diameternet-diameter**. The parameter **net-diameter** is valid only to CIST. After configuration, three STP time parameters are automatically updated to comparatively better values.

Run the following command to configure **net-diameter**:

Command	Purpose
spanning-tree mstp diameternet-diameter	Configures net-diameter. The parameter net-diameter ranges from 2 to 7. The default value is 7.
no spanning-tree mstp diameter	Resumes net-diameter to the default value.

The parameter **net-diameter** is not saved as an independent setup in the switch. Only when modified by setting the network diameter can the time parameter be saved.

19.2.3.9 Configuring Maximum Hop Count

Run the following command to configure the maximum hop count.

Command	Purpose
spanning-tree mstp max-hopshop-count	Sets the maximum hops. hop-count ranges from 1 to 40. Its default value is 20.
no spanning-tree mstphop-count	Resumes the maximum hop count to the default value.

19.2.3.10 Configuring Port Priority

If a loop occurs between two ports of the switch, the port with higher priority will enter the **forwarding** state and the port with lower priority is blocked. If all ports have the same priority, the port with smaller port number will first enter the **forwarding** state.

In port configuration mode, run the following command to set the priority of the STP port:

Command	Purpose
---------	---------

spanning-tree mstpinstance-idport-prioritypriority	Sets the priority of the STP port. instance-id stands for the number of the spanning tree instance, ranging from 0 to 15. priority stands for the port priority. It can be one of the following values: 0, 16, 32, 48, 64, 80, 96, 112 128, 144, 160, 176, 192, 208, 224, 240
spanning-tree port-priorityvalue	Sets the port priority in all spanning tree instances. value stands for the port priority. It can be one of the following values: 0, 16, 32, 48, 64, 80, 96, 112 128, 144, 160, 176, 192, 208, 224, 240
no spanning-tree mstpinstance-id port-priority	Resumes the port priority to the default value.
no spanning-tree port-priority	Resumes the port priority to the default value in all spanning tree instances.

Run the following command to check the information about the MSTP port.

Command	Purpose
show spanning-tree mstpinterfaceinterface-id	Check MSTP port information. interface-id stands for the port name, such as "F0/1" and "FastEthernet0/3".

19.2.3.11 Configuring Path Cost of the Port

In MSTP, the default value of the port's path cost is based on the connection rate. If a loop occurs between two switches, the port with less path cost will enter the forwarding state. The less the path cost is, the higher rate the port is. If all ports have the same path cost, the port with smaller port number will first enter the forwarding state.

In port configuration mode, run the following command to set the path cost of the port:

Command	Purpose
spanning-tree mstpinstance-idcostcost	Sets the path cost of the port. instance-id stands for the number of the spanning tree instance, ranging from 0 to 15. cost stands for the path cost of the port, which ranges from 1 to 200000000.
spanning-tree costvalue	Sets the path cost of the port in all spanning tree instances. Value stands for the path cost of the port, which ranges from 1 to 200000000.

no spanning-tree mstpinstance-idcost	Resumes the path cost of the port to the default value.
no spanning-tree cost	Resumes the path cost of the port to the default value in all spanning tree instances.

19.2.3.12 Configuring Port Connection Type

If the connection between MSTP-supported switches is the point-to-point direct connection, the switches can rapidly establish connection through handshake mechanism. When you configure the port connection type, set the port connection to the point-to-point type.

The protocol decides whether to use the point-to-point connection or not according to the duplex attribute. If the port works in full-duplex mode, the protocol considers the connection is a point-to-point one. If the port works in the half-duplex mode, the protocol considers the connection is a shared one.

If the switch that the port connects run the RSTP protocol or the MSTP protocol, you can set the port connection type to **point-to-point**, ensuring that a handshake is rapidly established.

In port configuration mode, run the following command to set the port connection type.

Command	Purpose
spanning-tree mstp point-to-point force-true	Sets the port connection type to point-to-point.
spanning-tree mstp point-to-point force-false	Sets the port connection type to shared.
spanning-tree mstp point-to-point auto	Automatically checks the port connection type.
no spanning-tree mstp point-to-point	Resumes the port connection type to the default settings.

19.2.3.13 Activating MST-Compatible Mode

The MSTP protocol that our switches support is based on IEEE 802.1s. In order to be compatible with other MSTPs, especially MSTP that the Cisco switches support, the MSTP protocol can work in MST-compatible mode. Switches running in MST-compatible mode can identify the message structure of other MSTPs, check the contained MST regional identifier and establish the MST region.

The MST-compatible mode and the STP-compatible mode are based on MSTP protocol conversion mechanism. If one port of the switch receives BPDU in compatible mode, the port automatically changes to the mode and sends BPDU in compatible mode. To resume the port to standard MST mode, you can run **spanning-tree mstp migration-check**.

In global configuration mode, run the following commands to enable or disable the MST-compatible mode:

Command	Purpose
spanning-tree mstp mst-compatible	Enable the MST-compatible mode of the switch.
no spanning-tree mstp mst-compatible	Disable the MST-compatible mode of the switch.

The main function of the compatible mode is to create the MST area for switches and other MSTP-running switches. In actual networking, make sure that the switch has the same configuration name and the same edit number. It is recommended to configure switches running other MSTP protocols to the CIST root, ensuring that the switch enters the compatible mode by receiving message.



If the MST-compatible mode is not activated, the switch will not resolve the whole BPDU-compatible content and take the content as the common RSTP BPDU. In this way, the switch cannot be in the same area with the MST-compatible switch that it connects.

A port in compatible mode cannot automatically resumes to send standard MST BPDU even if the compatible mode is shut down in global configuration mode. In this case, run **migration-check**.

19.2.3.14 Restarting Protocol Conversion Check

MSTP allows the switch to work with the traditional STP switch through protocol conversion mechanism. If one port of the switch receives the STP configuration message, the port then only transmits the STP message. At the same time, the port that receives the STP information is then considered as a boundary port.

When a port is in the STP-compatible state, the port will not automatically resume to the MSTP state even if the port does not receive the STP message any more. In



this case, you can run `spanning-tree mstp migration-check` to clear the STP message that the port learned, and make the port to return to the MSTP state.

The switch that runs the RSTP protocol can identify and handle the MSTP message. Therefore, the MSTP switch does not require protocol conversion when it works with the RSTP switch.

In global configuration mode, run the following command to clear all STP information that is detected by all ports of the switch:

Command	Purpose
<code>spanning-tree mstp migration-check</code>	Clears all STP information that is detected by all ports of the switch.

In port configuration mode, run the following command to clear STP information detected by the port.

Command	Purpose
<code>spanning-tree mstp migration-check</code>	Clears STP information detected by the port.

19.2.3.15 Checking MSTP Information

In monitor command, global configuration command or port configuration command, run the following command to check all information about MSTP.

Command	Purpose
show spanning-tree	Checks MSTP information. (Information about SSTP, PVST, RSTP and MSTP can be checked)
show spanning-tree detail	Checks the details of MSTP information. (Information about SSTP, PVST, RSTP and MSTP can be checked))
show spanning-tree interface <i>interface-id</i>	Checks the STP interface information. (Information about SSTP, PVST, RSTP and MSTP can be checked))
show spanning-tree mstp	Checks all MST instances.
show spanning-tree mstp region	Checks the MST area configuration.
show spanning-tree mstp instance <i>instance-id</i>	Checks information about a MST instance.
show spanning-tree mstp detail	Checks detailed MST information.
show spanning-tree mstp interface <i>interface-id</i>	Checks MST port configuration.
show spanning-tree mstp protocol-migration	Checks the protocol conversion state of the port.

Chapter 20. STP Optional Characteristic Configuration

20.1 Configuring STP Optional Characteristic

20.1.1 STP Optional Characteristic Introduction

The spanning tree protocol module of the switch supports seven additional features (the so-called optional features). These features are not configured by default. The supported condition of various spanning tree protocol modes towards the optional characteristics is as follows:

Optional Characteristic	Single STP	PVST	RSTP	MSTP
Port Fast	Yes	Yes	No	No
BPDU Guard	Yes	Yes	Yes	Yes
BPDU Filter	Yes	Yes	No	No
Uplink Fast	Yes	Yes	No	No
Backbone Fast	Yes	Yes	No	No
Root Guard	Yes	Yes	Yes	Yes
Loop Guard	Yes	Yes	Yes	Yes

20.1.1.1 Port Fast

Port Fast immediately brings an interface configured as an access or trunk port to the forwarding state from a blocking state, bypassing the listening and learning states. You can use Port Fast on interfaces connected to a single workstation or server, to allow those devices to immediately connect to the network, rather than waiting for the spanning tree to converge.

Interfaces connected to a single workstation or server should not receive bridge protocol data units (BPDUs). An interface with Port Fast enabled goes through the normal cycle of spanning-tree status changes when the switch is restarted.

Because the purpose of Port Fast is to minimize the time interfaces must wait for spanning-tree to converge, it is effective only when used on interfaces connected to end stations. If you enable Port Fast on an interface connecting to another switch, you risk creating a spanning-tree loop.

You can enable this feature by using the spanning-tree portfast interface configuration or the spanning-tree portfast default global configuration command.

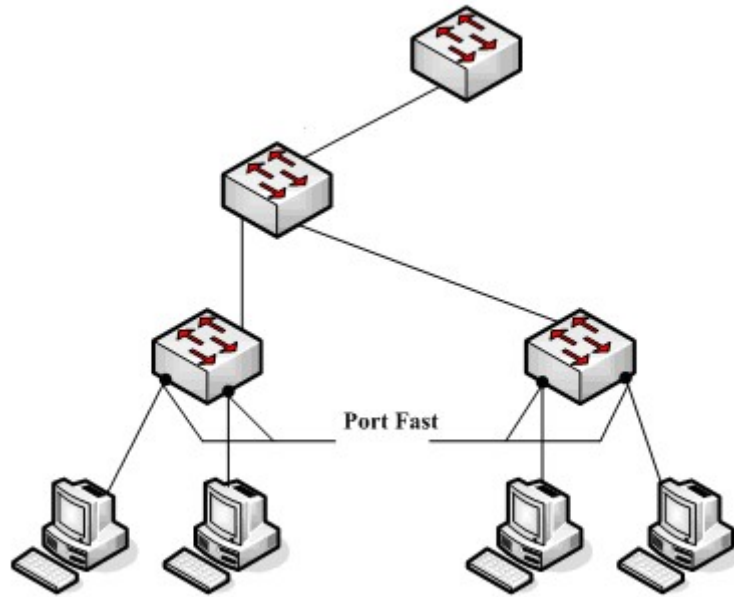

Figure 1.1 Port Fast

Instruction:

For the rapid convergent spanning tree protocol, RSTP and MSTP, can immediately bring an interface to the forwarding state, and therefore there is no need to use Port Fast feature.

20.1.1.2 BPDU Guard

The BPDU guard feature can be globally enabled on the switch or can be enabled per port, but the feature operates with some differences.

At the global level, you enable BPDU guard on Port Fast-enabled ports by using the `spanning-tree portfast bpduguard default` global configuration command. Spanning tree shuts down ports that are in a Port Fast-operational state if any BPDU is received on them. In a valid configuration, Port Fast-enabled ports do not receive BPDUs. Receiving a BPDU on a Port Fast-enabled port means an invalid configuration, such as the connection of an unauthorized device, and the BPDU guard feature puts the port in the error-disabled state. When this happens, the switch shuts down the entire port on which the violation occurred.

To prevent the port from shutting down, you can use the `errdisable detect cause bpduguard shutdown` **VLAN global configuration** command to shut down just the offending VLAN on the port where the violation occurred.

At the interface level, you enable BPDU guard on any port by using the `spanning-tree bpduguard enable` **interface configuration** command without also enabling the Port Fast feature. When the port receives a BPDU, it is put in the error-disabled state.

The BPDU guard feature provides a secure response to invalid configurations because you must manually put the interface back in service. Use the BPDU guard feature in a service-provider network to prevent an access port from participating in the spanning tree.

20.1.1.3 BPDU Filter

The BPDU filtering feature can be globally enabled on the switch or can be enabled per interface, but the feature operates with some differences.

In SSTP/PVST mode, if a **Port Fast** port with BPDU filter configured receives the BPDU, the features BPDU Filter and Port Fast at the port will be automatically disabled, resuming the port as a normal port. Before entering the **Forwarding** state, the port must be in the **Listening** state and **Learning** state.

The BPDU Filter feature can be configured in global configuration mode or in port configuration mode. In global configuration mode, run the command **spanning-tree portfast bpdudfilter** to block all ports to send BPDU out. The port, however, can still receive and process BPDU.

20.1.1.4 Uplink Fast

The feature **Uplink Fast** enables new root ports to rapidly enter the **Forwarding** state when the connection between the switch and the root bridge is disconnected.

A complex network always contains multiple layers of devices, as shown in figure 1.2. Both aggregation layer and the access layer of the switch have redundancy connections with the upper layer. These redundancy connections are normally blocked by the STP to avoid loops.

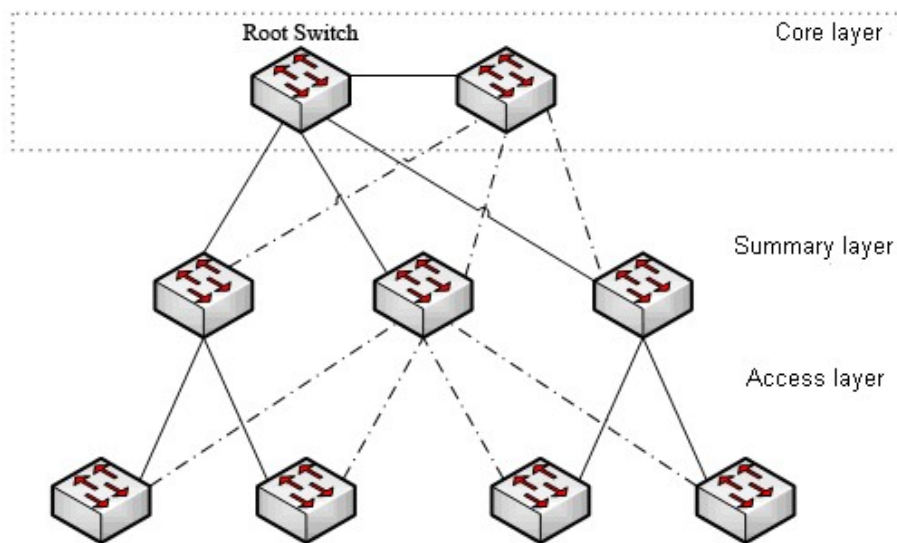

Figure 1.2 Switching network topology

Suppose the connection between a switch and the upper layer is disconnected (called as Direct Link Failure), the STP chooses the Alternate port on the redundancy line as the root port. Before entering the **Forwarding** state, the Alternate port must be in the **Listening** state and **Learning** state. If the **Uplink Fast** feature is configured by running the command **spanning-tree uplinkfast** in global configuration mode, new root port can directly enter the forwarding state, resuming the connection between the switch and the upper layer. Figure 1.3 shows the working principle of the **Uplink Fast** feature. The port for switch C to connect switch B is the standby port when the port is in the original state. When the connection between switch C and root switch A is disconnected, the previous **Alternate** port is selected as new root port and immediately starts forwarding.

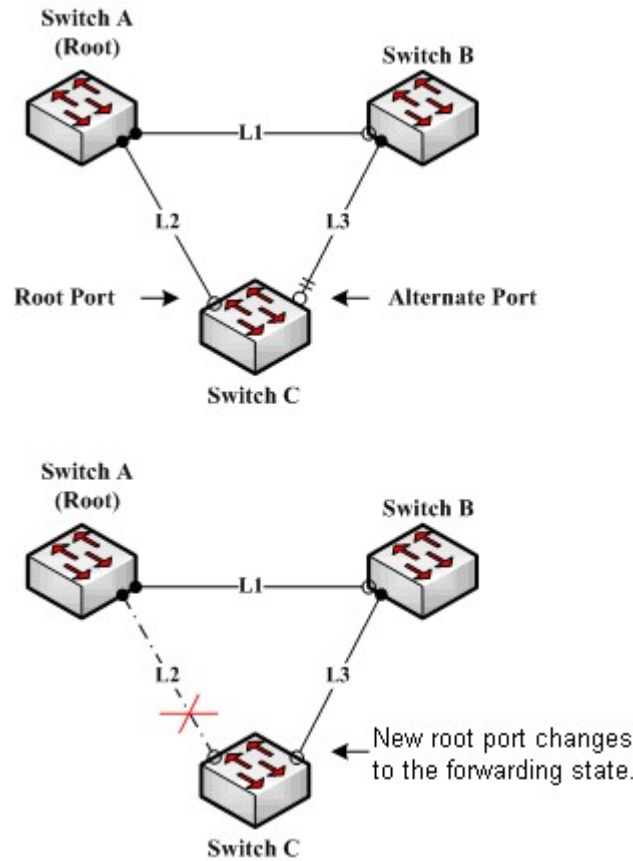

Figure 1.3 Uplink Fast



The Uplink Fast feature adjusts to the slowly convergent SSTP and PVST. In RSTP and MSTP mode, new root port can rapidly enter the Forwarding state without the Uplink Fast function.

20.1.1.5 Backbone Fast

The **Backbone Fast** feature is a supplement of the **Uplink Fast** technology. The **Uplink Fast** technology makes the redundancy line rapidly work in case the direct connection to the designated switch is disconnected, while the **Backbone Fast** technology detects the indirect-link network blackout in the upper-layer network and boosts the change of the port state.

In figure 1.3, Connection L2 between switch C and switch A is called as the direct link between switch C and root switch A. If the connection is disconnected, the **Uplink Fast** function can solve the problem. Connection L1 between switches A and B is called as the indirect link of switch C. The disconnected indirect link is called as indirect failure, which is handled by the **Backbone Fast**function.

The working principle of the Backbone Fast function is shown in Figure 1.4.

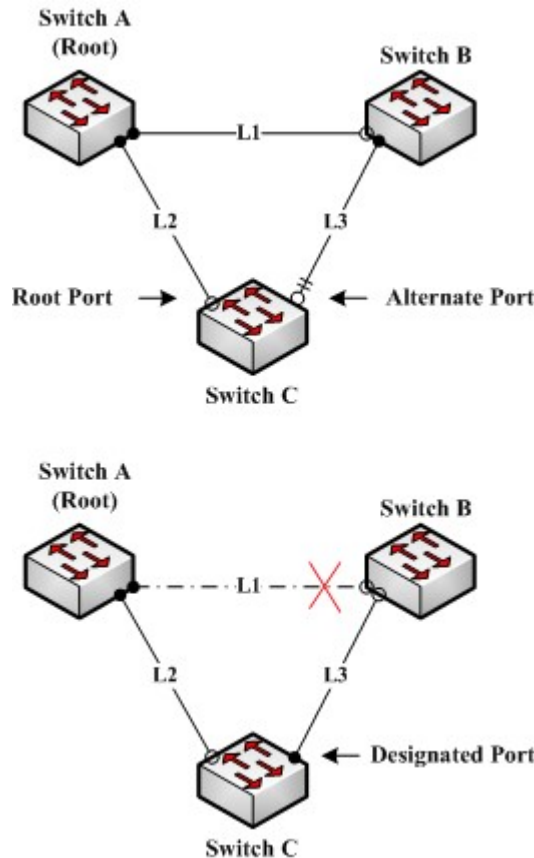

Figure 1.4 Backbone Fast

Suppose the bridge priority of switch C is higher than that of switch B. When L1 is disconnected, switch B is selected to send BPDU to switch C because the bridge priority is used as root priority. To switch C, the information contained by BPDU is not prior to information contained by its own. When Backbone Fast is not enabled, the port between switch C and switch B ages when awaiting the bridge information and then turns to be the designated port. The aging normally takes a few seconds. After the function is configured in global configuration mode by running the command **spanning-tree backbonefast**, when the Alternate port of switch C receives a BPDU with lower priority, switch C thinks that an indirect-link and root-switch-reachable connection on the port is disconnected. Switch C then promptly update the port as the designated port without waiting the aging information.

After the Backbone Fast function is enabled, if BPDU with low priority is received at different ports, the switch will perform different actions. If the Alternate port receives the message, the port is updated to the designated port. If the root port receives the low-priority message and there is no other standby port, the switch turns to be the root switch.

Note that the Backbone Fast feature just omits the time of information aging. New designated port still needs to follow the state change order: the listening state, then the learning state and finally the forwarding state.



Similar to Uplink Fast, the Backbone Fast feature is effective in SSTP and PVST modes.

20.1.1.6 Root Guard

The Root Guard feature prevents a port from turning into a root port because of receiving high-priority BPDU. The Layer 2 network of a service provider (SP) can include many connections to switches that are not owned by the SP. In such a topology, the spanning tree can reconfigure itself and select a customer switch as the root switch, as shown in Figure 17-8. You can avoid this situation by enabling root guard on SP switch interfaces that connect to switches in your customer's network. If spanning-tree calculations cause an interface in the customer network to be selected as the root port, root guard then places the interface in the root-inconsistent (blocked) state to prevent the customer's switch from becoming the root switch or being in the path to the root. If a switch outside the SP network becomes the root switch, the interface is blocked (root-inconsistent state), and spanning tree selects a new root switch. The customer's switch does not become the root switch and is not in the path to the root.

If the switch is operating in multiple spanning-tree (MST) modes, root guard forces the interface to be a designated port. If a boundary port is blocked in an internal spanning-tree (IST) instance because of root guard, the interface also is blocked in all MST instances. A boundary port is an interface that connects to a LAN, the designated switch of which is either an IEEE 802.1D switch or a switch with a different MST region configuration.

Root guard enabled on an interface applies to all the VLANs to which the interface belongs. VLANs can be grouped and mapped to an MST instance.

You can enable this feature by using the spanning-tree guard root interface configuration command.



Root Guard feature acts differently somehow in SSTP/PVST and RSTP/MSTP. In SSTP/PVST mode, Root port is always blocked by Root Guard. In RSTP/MSTP mode, Root port won't be blocked until receiving higher level BPDU. A port which formerly plays the Root role will not be blocked.

20.1.1.7 Loop Guard

You can use loop guard to prevent alternate or root ports from becoming designated ports because of a failure that leads to a unidirectional link. This feature is most effective when it is enabled on the entire switched network. Loop guard prevents alternate and root ports from becoming designated ports, and spanning tree does not send BPDUs on root or alternate ports.

You can enable this feature by using the spanning-tree loopguard default global configuration command.

When the switch is operating in PVST+ or rapid-PVST+ mode, loop guard prevents alternate and root ports from becoming designated ports, and spanning tree does not send BPDUs on root or alternate ports.

When the switch is operating in MST mode, BPDUs are not sent on nonboundary ports only if loop guard in all MST instances blocks the interface. On a boundary port, loop guard blocks the interface in all MST instances.



Loop Guard feature acts differently somehow in SSTP/PVST and RSTP/MSTP. In SSTP/PVST mode, the designated port is always be blocked by Loop Guard. In RSTP/MSTP mode, the port will be blocked only when it changes into the designated port because of inaccessibility to receiving BPDU. Loop Guard will not block a port, which is provided with the designated role due to receiving the lower

level BPDU.

20.1.2 Configuring STP Optional Characteristic

20.1.2.1 STP Optional Characteristic Configuration Task

-
- Configuring Port Fast
-
- Configuring BPDU Guard
-
- Configuring BPDU Filter
-
- Configuring Uplink Fast

20.1.2.2 Configuring Port Fast

An interface with the Port Fast feature enabled is moved directly to the spanning-tree forwarding state without waiting for the standard forward-time delay.

Use the following command to configure the port fast feature in the global configuration mode:

command	purpose
spanning-tree port fast default	Globally enables port fast feature. It is valid to all interfaces.
no spanning-tree portfast default	Globally disables port fast feature. It has no effect on the interface configuration.



The port fast feature only applies to the interface that connects to the host. The BPDU Guard or BPDU Filter must be configured at the same time when the port fast feature is configured globally.

Use the following command to configure the port fast feature in the interface configuration mode:

command	purpose
spanning-tree portfast	Enables port fast feature on the interface.
no spanning-tree portfast	Disables port fast feature on the interface. It has no effect on the global configuration.

20.1.2.3 Configuring BPDU Guard

When you globally enable BPDU guard on ports that are Port Fast-enabled (the ports are in a Port Fast-operational state), spanning tree shuts down Port Fast-enabled ports that receive BPDUs.

In a valid configuration, Port Fast-enabled ports do not receive BPDUs. Receiving a BPDU on a Port Fast-enabled port means an invalid configuration, such as the connection of an unauthorized device, and the

BPDU guard feature puts the port in the error-disabled state. When this happens, the switch shuts down the entire port on which the violation occurred.

To prevent the port from shutting down, you can use the **errdisable detect cause bpduguard shutdown vlan global configuration** command to shut down just the offending VLAN on the port where the violation occurred.

The BPDU guard feature provides a secure response to invalid configurations because you must manually put the port back in service. Use the BPDU guard feature in a service-provider network to prevent an access port from participating in the spanning tree.

Follow these steps to globally enable the BPDU guard feature:

command	purpose
spanning-tree portfast bpduguard	Globally enables bpdu guard feature. It is valid to all interfaces.
no spanning-tree portfast bpduguard	Globally disables bpdu guard feature.

Instruction:

Globally enabling port fast feature may result in broadcast storm. The BPDU Guard or BPDU Filter should be configured for protection sake.

Follow these steps to enable the BPDU guard feature in interface configuration mode:

Command	Purpose
spanning-tree bpduguard enable	Enables bpdu guard feature on the interface.
spanning-tree bpduguard disable	Disables bpdu guard feature on the interface. It has no effect on the global configuration.
no spanning-tree bpduguard	Disables bpdu guard feature on the interface. It has no effect on the global configuration.

20.1.2.4 Configuring BPDU Filter

When you globally enable BPDU filtering on Port Fast-enabled interfaces, it prevents interfaces that are in a Port Fast-operational state from sending or receiving BPDUs. The interfaces still send a few BPDUs at link-up before the switch begins to filter outbound BPDUs. You should globally enable BPDU filtering on a switch so that hosts connected to these interfaces do not receive BPDUs. If a BPDU is received on a Port Fast-enabled interface, the interface loses its Port Fast-operational status, and BPDU filtering is disabled.

Follow these steps to globally enable the BPDU filter feature.:

Command	Purpose
---------	---------

spanning-tree portfast bpdufilter	Globally enables bpdu filter feature. It is valid to all interfaces.
no spanning-tree portfast bpdufilter	Globally disables bpdu filter feature.

Instruction:

Globally enabling port fast feature may result in broadcast storm. The BPDU Guard or BPDU Filter should be configured for protection sake.

Follow these steps to enable the BPDU filter feature in the interface configuration mode :

Command	Purpose
spanning-tree bpdufilter enable	Enables bpdu filter feature on the interface.
spanning-tree bpdufilter disable	Disables bpdu filter feature. It has no effect on the global configuration.
no spanning-tree bpdufilter	Disables bpdu filter feature. It has no influence on the global configuration.

20.1.2.5 Configuring Uplink Fast

If a switch loses connectivity, it begins using the alternate paths as soon as the spanning tree selects a new root port. By enabling UplinkFast with the spanning-tree uplinkfast global configuration command, you can accelerate the choice of a new root port when a link or switch fails or when the spanning tree reconfigures itself. The root port transitions to the forwarding state immediately without going through the listening and learning states, as it would with the normal spanning-tree procedures.

Uplink Fast feature is only valid in SSTP/PVST mode.

Follow these steps to globally enable UplinkFast.:

Command	Purpose
spanning-tree uplinkfast	Enables uplink fast feature.
no spanning-tree uplinkfast	Disables uplink fast feature.

20.1.2.6 Configuring Backbone Fast

BackboneFast is a complementary technology to the UplinkFast feature, which responds to failures on links directly connected to access switches. BackboneFast optimizes the maximum-age timer, which controls the amount of time the switch stores protocol information received on an interface. When a switch receives an inferior BPDU from the designated port of another switch, the BPDU is a signal that the other switch might have lost its path to the root, and BackboneFast tries to find an alternate path to the root.

Backbone fast feature is only valid in SSTP/PVST mode.

Follow these steps to globally enable BackboneFast.:

Command	Purpose
spanning-tree backbonefast	Enables backbone fast feature.
no spanning-tree backbonefast	Disables backbone fast feature.

20.1.2.7 Configuring Root Guard

Root guard enabled on an interface applies to all the VLANs to which the interface belongs. Do not enable the root guard on interfaces to be used by the UplinkFast feature. With UplinkFast, the backup interfaces (in the blocked state) replace the root port in the case of a failure. However, if root guard is also enabled, all the backup interfaces used by the UplinkFast feature are placed in the root-inconsistent state (blocked) and are prevented from reaching the forwarding state.

Root Guard feature acts differently somehow in SSTP/PVST and RSTP/MSTP. In SSTP/PVST mode, Root port is always blocked by Root Guard. In RSTP/MSTP mode, Root port won't be blocked until receiving higher level BPDU. A port which formerly plays the Root role will not be blocked.

Follow these steps to enable root guard on an interface.:

Command	Purpose
spanning-tree guard root	Enables root guard feature on the interface.
no spanning-tree guard	Disables root guard and loop guard features on the interface.
spanning-tree guard none	Disables root guard and loop guard features on the interface.

20.1.2.8 Configuring Loop Guard

You can use loop guard to prevent alternate or root ports from becoming designated ports because of a failure that leads to a unidirectional link. This feature is most effective when it is configured on the entire switched network. Loop guard operates only on interfaces that are considered point-to-point by the spanning tree.

Loop Guard feature acts differently somehow in SSTP/PVST. In SSTP/PVST mode,, the designated port is always blocked by Loop Guard. In RSTP/MSTP, the designated port is always blocked by Loop Guard. In RSTP/MSTP mode, the port will be blocked only when it changes into the designated port because of inaccessibility to receiving BPDU. A port which is provided with the designated role due to receiving the lower level BPDU will not be blocked by Loop Guard.

Follow these steps to enable loop guard in global configuration mode.:

Command	Purpose
spanning-tree loopguard default	Globally enables loop guard feature. It is valid to all interfaces.
no spanning-tree loopguard default	Globally disables loop guard.

Follow these steps to enable loop guard in the interface configuration mode.:

Command	Purpose
spanning-tree guard loop	Enables loop guard feature on the interface.
no spanning-tree guard	Disables root guard and loop guard feature on the interface.
spanning-tree guard none	Disables root guard and loop guard on the interface.

Chapter 21. Link Aggregation Configuration

21.1 Configuring Port Aggregation

21.1.1 Overview

Link aggregation, also called trunking, is an optional feature available on the Ethernet switch and is used with Layer 2 Bridging. Link aggregation allows logical merge of multiple ports in a single link. Because the full bandwidth of each physical link is available, inefficient routing of traffic does not waste bandwidth. As a result, the entire cluster is utilized more efficiently. Link aggregation offers higher aggregate bandwidth to traffic-heavy servers and reroute capability in case of a single port or cable failure.

Supported Features:

- Static aggregation control is supported

Bind a physical port to a logical port, regardless whether they can actually bind to a logical port.

Aggregation control of LACP dynamic negotiation is supported

Only a physical port that passes the LACP protocol negotiation can bind to a logical port. Other ports won't bind to the logical port.

- Aggregation control of LACP dynamic negotiation is supported

When a physical port is configured to bind to a logical port, the physical port with LACP negotiation can be bound to a logical port. Other ports cannot be bound to the logical port.

- Flow balance of port aggregation is supported.

After port aggregation, the data flow of the aggregation port will be distributed to each aggregated physical port.

21.1.2 Port Aggregation Configuration Task List

- Configuring logical channel used for aggregation
- Aggregation of physical port
- Selecting load balance mode after port aggregation
- Monitoring the concrete condition of port aggregation

21.1.3 Port Aggregation Configuration Task

21.1.3.1 Configuring Logical Channel Used to Aggregation

You should establish a logical port before binding all the physical ports together. The logical port is used to control the channel formed by these binding physical ports.

Use the following command to configure the logical channel:

Command	Description
interface port-aggregator id	Configures aggregated logical channel.

21.1.3.2 Aggregation of Physical Port

To aggregate multiple physical ports into a logical channel, you can use static aggregation or LACP protocol for negotiation.

In the case when the static aggregation is used, it is required that the link of the physical port should be up, and the VLAN attribute of aggregation port and physical port should be identical, and then this port will be aggregated to the logical channel, regardless of whether the current port accords with the conditions of port aggregation and whether the port that connects with the physical port accords with the aggregation conditions.

Prerequisites for ports to be aggregated:

- The link of the port must be up and the port should be negotiated to full-duplex mode.
- The speed of all physical ports should be same during aggregation process, that is, if there is one physical port that has been aggregated successfully, then the speed of the second physical port must be the same as the first configured one. Also the vlan attributes of all physical ports must be identical to the aggregated port.

LACP packets are exchanged between ports in these modes:

- Active—Places a port into an active negotiating state, in which the port initiates negotiations with remote ports by sending LACP packets.
- Passive—Places a port into a passive negotiating state, in which the port responds to LACP packets it receives but does not initiate LACP negotiation. In this mode, the port channel group attaches the interface to the bundle.

If both ports use Passive method, then the aggregation fails. This is because both sides will wait for the other side to launch aggregation negotiation process.

VALN attributes: PVID, Trunk attribute, vlan-allowed range and vlan-untagged range.

Use the following command to perform aggregation on the physical ports:

Command	Description
aggregator-group <i>agg-id</i> mode { lacp static }	Configures aggregation option of the physical port.

21.1.3.3 Selecting Load Balance Method After Port Aggregation

You can select the load share method to ensure that all ports can share the data traffic after the aggregation of all physical ports. The switch can provides up to six load balance strategy:

- src-mac

It is to share the data traffic according to the source MAC address, that is, the message with same MAC

address attributes is to get through a physical port.

- `dst-mac`

It is to share the data traffic according to the destination MAC address, that is, the message with same MAC address attributes is to get through a physical port.

- `both-mac`

It is to share the data traffic according to source and destination MAC addresses, that is, the message with same MAC address attributes is to get through a physical port.

- `src-ip`

It is to share the data traffic according to the source IP address, that is, the message with same IP address attributes is to get through a physical port.

- `dst-ip`

It is to share the data traffic according to the destination IP address, that is, the message with same IP address attributes is to get through a physical port.

- `both-ip`

It is to share the data traffic according to the destination and source IP addresses, that is, the message with same IP address attributes is to get through a physical port.

Use the following command to configure load balance method:

Command	Description
<code>aggregator-group load-balance</code>	Configures load balance method.

21.1.3.4 Monitoring the Concrete Conditions of Port Aggregation

Use the following command to monitor port aggregation state in EXEC mode:

Command	Description
<code>show aggregator-group</code>	Displays port aggregation state.

Chapter 22. PDP Configuration

22.1 PDP Overview

22.1.1 Overview

PDP is specially used to discover network equipment, that is, it is used to find all neighbors of a known device. Through PDP, the network management program can use SNMP to query neighboring devices to acquire network topology.

Our company's switches can discover the neighboring devices but they do not accept SNMP queries.

Therefore, switches only run at the edge of network, or they cannot acquire a complete network topology.

PDP can be set on all SNAPs (e.g. Ethernet).

22.1.2 PDP Configuration Tasks

- Default PDP Configuration
- Setting the PDP Clock and Information Storage
- Setting the PDP Version
- Starting PDP on a Switch
- Starting PDP on a Port
- PDP Monitoring and Management

22.1.2.1 Default PDP Configuration

Function	Default Settings
Global configuration mode	This function is not enabled by default.
Interface configuration mode	Starts up.
PDP clock (packet transmission frequency)	60 seconds
PDP information storage	180 seconds
PDP version	2

22.1.2.2 Setting the PDP Clock and Information Storage

To set the PDP packet transmission frequency and the PDP information storage time, you can run the following commands in global configuration mode.

Command	Purpose
pdp timer seconds	Sets the transmission frequency of the PDP packets.
pdp holdtime seconds	Sets the PDP information storage time.

22.1.2.3 Setting the PDP Version

To set the PDP version, you can run the following command in global configuration mode.

Command	Purpose
pdp version {1 2}	Setts the PDP version.

22.1.2.4 Starting PDP on a Switch

To enable PDP, you can run the following commands in global configuration mode.

Command	Purpose
pdp run	Starts PDP on a switch.

22.1.2.5 Starting PDP on a Port

To enable PDP on a port by default, you can run the following command in port configuration mode.

Command	Purpose
pdp enable	Starts PDP on a port of a switch.

22.1.2.6 PDP Monitoring and Management

To monitor the PDP, run the following commands in EXEC mode:

Command	Purpose
show pdp traffic	Displays the counts of received and transmitted PDP packets.
show pdp neighbor [detail]	Displays neighbors that PDP discovers.

22.1.3 PDP Configuration Example

Example 1: Starting PDP

```
Switch_config# pdp run
```

```
Switch_config# int f0/1
```

```
Switch_config_f0/1#pdp enable
```

Example 2: Setting the PDP clock and information storage

```
Switch_config#pdp timer 30
```

```
Switch_config#pdp holdtime 90
```

Example 3: Setting the PDP version

```
Switch_config#pdp version 1
```

Example 4: Monitoring PDP

```
Switch_config#show pdp neighbor
```

Capability Codes: R - Router, T - Trans Bridge, B - Source Route Bridge

S - Switch, H - Host, I - IGMP, r - Repeater

Device-ID	Local-Intf	Hldtme	Port-ID	Platform	Capability
Switch	Fas0/1	169	Gig0/1	COMPANY, RISC	R S

Chapter 23. LLDP Configuration

23.1 LLDP

23.1.1 LLDP Introduction

The 802.1AB link layer discovery protocol (LLDP) at 802.1AB helps to detect network troubles easily and maintain the network topology.

LLDP is a unidirectional protocol. One LLDP agent transmits its state information and functions through its connected MSAP, or receives the current state information or function information about the neighbor.

However, the LLDP agent cannot request any information from the peer through the protocol.

During message exchange, message transmission and reception do not affect each other. You can configure only message transmission or reception or both.

LLDP is a useful management tool, providing management personnel exact network mapping, traffic data and trouble detection information.

23.1.2 LLDP Configuration Task List

- Disabling / enabling LLDP
- Configuring holdtime
- Configuring timer
- Configuring reinit
- Configuring to-be-sent tlv
- Configuring the transmission / reception mode
- Configuring show-relative commands
- Configuring deletion commands
- Configuring debugging commands

23.1.3 LLDP Configuration Task

23.1.3.1 Disabling / enabling LLDP

LLDP is disabled by default. You need start up LLDP before it runs.

Run the following command in global configuration mode to enable LLDP:

Command	Purpose
lldprun	Runs LLDP.

Run the following command to disable LLDP:

Command	Purpose
no lldprun	Disables LLDP.

23.1.3.2 Configuring holdtime

You can control the timeout time of transmitting the LLDP message through modifying **holdtime**:

Run the following command in global configuration mode to configure **holdtime** of LLDP:

Command	Purpose
lldpholdtime <i>time</i>	Configures the timeout time of LLDP.
nolldpholdtime	Resumes the timeout time to the default value, 120 seconds.

23.1.3.3 Configuring timer

You can control the interval of the switch to transmit message by configuring the timer of LLDP.

Run the following command in global configuration mode to configure **timer** of LLDP:

Command	Purpose
lldptimer <i>time</i>	Configures the interval of message transmission of LLDP.
no lldptimer	Resumes the default interval, that is, 30 seconds.

23.1.3.4 Configuring reinit

You can control the interval of the switch to continuously transmit two messages by configuring **reinit** of LLDP.

Run the following command in global configuration mode to configure **reinit** of LLDP:

Command	Purpose
lldpreinit <i>time</i>	Configures the interval of LLDP to continuously transmit message.
no lldpreinit	Resumes the default interval of continuously transmitting message; the default interval value is two seconds.

23.1.3.5 Configuring To-Be-Sent TLV

You can choose TLV which requires to be sent by configuring **tlv-select** of LLDP. By default, all TLVs are transmitted.

Run the following commands in global configuration mode to add or delete **tlv** of LLDP:

Command	Purpose
lldptlv-select <i>tlv-type</i>	Tlvs or tlv-types which needs to be added include: macphy-config management-address port-description port-vlan

	system-capabilities system-description system-name
no lldptlv-selecttlv-type	Tlvs or tlv-types which needs to be deleted include: macphy-config management-address port-description port-vlan system-capabilities system-description system-name

23.1.3.6 Configuring the Transmission or Reception Mode

LLDP can work under three modes: transmit-only, receive-only and transmit-and-receive.

By default, LLDP works under the transmit-and-receive mode. You can modify the working mode of LLDP through the following commands.

Run the following command in interface configuration mode to configure the working mode of LLDP:

Command	Purpose
[no] lldptransmit	Sets the port to the transmit-only mode or disables the transmit-only mode of the port.
[no] lldpreceive	Sets the port to the receive-only mode or disables the receive-only mode of the port.

23.1.3.7 Configuring Show-Relative Commands

You can observe the information about the neighbor, statistics or port state received by the LLDP module by running show-relative commands.

Run the following commands in EXEC or global configuration mode:

Command	Purpose
showlldperrors	Displays the error information about the LLDP module.
showlldpinterface <i>interface-name</i>	Displays the information about port state, that is, the transmission mode and the reception mode.
showlldpneighbors	Displays the abstract information about the neighbor.

showlldpneighborsdetail	Displays the detailed information about the neighbor.
showlldptraffic	Displays all received and transmitted statistics information.

23.1.3.8 Configuring the Deletion Commands

You can delete the received neighbor lists and all statistics information by running the following command in EXEC mode.

Command	Purpose
clearlldpcounters	Deletes all statistics data.
clearlldpstable	Deletes all received neighbor information.

23.1.3.9 Configuring Debugging Commands

To easily monitor the LLDP module, run the following commands in EXEC mode:

Command	Purpose
debuglldperrors	Reports some error information about the LLDP module.
debuglldpevents	Reports some special events about the LLDP module.
debuglldppackets	Reports the message transmission event of the LLDP module.
debuglldp states	Reports the information about the state of the LLDP port.

Chapter 24. FlexLinkLite Configuration

24.1 FlexLinkLite Configuration

24.1.1 FlexLinkLite Overview

FlexLinkLite is used in a network environment to easily construct two uplink links, which back up each other. If STP is not enabled in this network environment, FlexLinkLite can avoid the loop and conduct fast switchover when a link is out of effect.

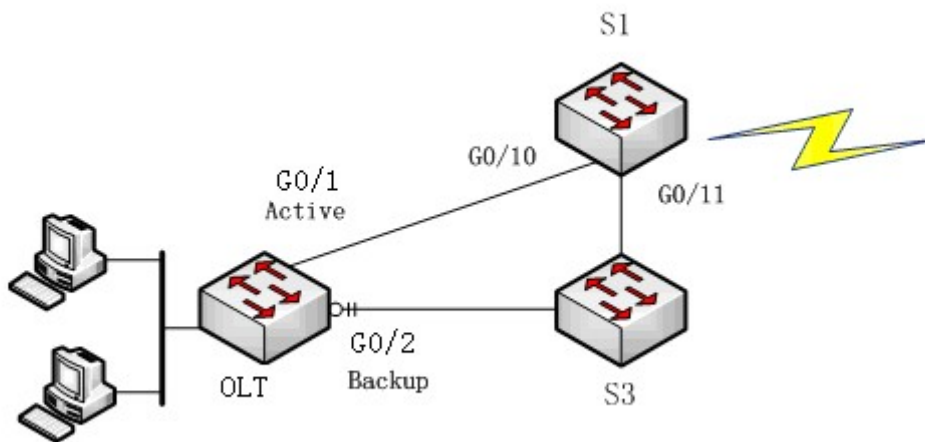

Figure 1: FlexLinkLite-enabled network

FlexLinkLite includes a pair of ports that back up each other. As shown in figure 1, FlexLinkLite is enabled on switch S2, and G5/1 and G5/2 are two ports that back up each other, the former being an active port while the latter being a backup port. In normal case, the active port forwards data and the backup port blocks data so as to avoid data loopback. If the active port's link is out of effect, the backup port will immediately begin to forward data.

A pair of ports, which back up each other, can be two physical ports, or a physical port and an aggregation port, or two aggregation ports. The port on which FlexLinkLite is set cannot be used for STP calculation or EAPS settings.

In case the links of two ports are up, the preempt mode is used to select which port to forward data.

FlexLinkLite only supports the preempt based on the preset role. As shown in figure 1, when a link is out of effect and the preempt is set, port G0/1 will replace port G0/2 to forward data and port G5/2 will block data.

FlexLinkLite also has a topology change notification mechanism. As shown in figure 1, port G0/2 of switch S2 replaces port G0/1 to start forwarding data; S2 sends the TCN packets positively, and S1, after receiving these TCN packets, immediately clears the MAC addresses that are learned by the downlink ports, G0/10 and G0/11, and switches the downlink data flow rapidly to the correct link. In general, the TCN mechanism can assure the successful switchover of the two-way flow in 50ms.

24.1.2 FlexLinkLite Configuration

24.1.2.1 Run the following commands to set the backup port:

Run the following commands to set the FlexLinkLite backup port:

Command	Purpose
Switch# configure	Enters the global configuration mode of the switch.
Switch_config# interface <i>intf-name</i>	Enters the interface configuration mode. Intf-name: stands for the name of a port, such as G0/1 or F0/10.
Switch_config_intf# switchport backup interface <i>backup-intf-name</i> as [active backup]	Sets another port to be the backup port of the current port. backup-intf-name: represents the name of another port. active: Stands for the active port, to which backup-intf-name corresponds, when the current port is a backup one. backup: Stands for the backup port, to which backup-intf-name corresponds, when the current port is an active one.

After **switchport backup interface** is set on an interface, the corresponding settings will automatically generate on the backup port without any manual operations.

However, if **no switchport backup interface** is run, a pair of ports, which back up each other, will be deleted.

24.1.2.2 Setting the Preempt of a Backup Port

Command	Purpose
Switch_config_intf# switchport bakcup interface preempt mode [none role]	Sets the preempt mode. none: represents no preempt. role: means the role-based preempt, which is the default settings of the active port.
Switch_config_intf# switchport backup interface preempt delay [immediately <i>time-sec</i>]	Sets the delay of the preempt. That is, it refers to the waiting time during which the link state will be resumed to preempt start. immediately: conducts the preempt without any delay.

	<p>time-sec: means the delay of preempt, whose unit is second.</p> <p>The default value is three seconds. The value ranges between 1 and 600 seconds.</p>
--	---

switchport backup interface preempt mode role is deemed as the default settings of each backup port pair.

24.1.2.3 Setting the Transmission and Reception of TCN Packets

Command	Purpose
Switch_config_intf# switchport bakcup interface tcn transmit	Allows a port to transmit the TCN packets.
Switch_config_intf# switchport backup interface tcn accept	Allows a port to process the TCN packets.

The **transmit** command can be enabled on the device with a configured backup port. When a backup port is switched, it will transmit the TCN packets.

The **accept** command can be enabled on the uplink device. If this command is enabled on a uplink device, it can receive the TCN packets and delete the MAC addresses that are learned by the downlink port.

24.1.3 FlexLinkLite Configuration Example

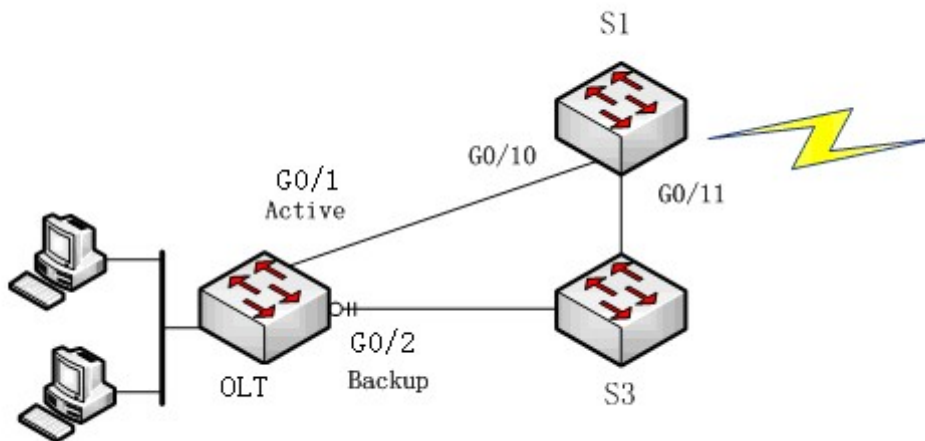

Figure 2: FlexLinkLite configuration example

Configuration

Run the following commands to set the backup port:

```
Switch# config
```

```
Switch_config# interface gigaEthernet 0/1
```

```
Switch_config_g0/1# switchport backup interface g0/2 as backup
```

Enable the default role-based preempt and set the delay to 15 seconds:

Switch_config_g0/1# switchport backup interface preempt delay 15

Make the following settings to enable the TCN packets to be transmitted:

Switch_config_g0/1# switchport backup interface tcn transmit

Switch_config_g0/1# interface g0/2

Switch_config_g0/2# switchport backup interface tcn transmit

Switch_config_g0/2# exit

Browse the state of the port:

Switch_config# show backup interfaces

Backup interface pairs:

<u>Active...</u>	<u>Backup...</u>	<u>State.....</u>	<u>Preemption</u>
G0/1	G0/2	Active Up/Backup Down	Role/15/0

Make the following settings to enable the TCN packets to be received:

Switch# config

Switch_config# interface range g0/10 , 11

Switch_config_if_range# switchport backup interface tcn accept

Switch_config_if_range# exit

Switch_config#

Chapter 25. BackupLink Configuration

25.1 BackupLink Overview

25.1.1 Overview

Link aggregation, also called trunking, is an optional feature available on the Ethernet switch and is used with Layer 2 Bridging. Link aggregation allows logical merge of multiple ports in a single link. Because the full bandwidth of each physical link is available, inefficient routing of traffic does not waste bandwidth. As a result, the entire cluster is utilized more efficiently. Link aggregation offers higher aggregate bandwidth to traffic-heavy servers and reroute capability in case of a single port or cable failure.

Supported Features:

Static aggregation control is supported

Bind a physical port to a logical port, regardless whether they can actually bind to a logical port.

Aggregation control of LACP dynamic negotiation is supported

Only a physical port that passes the LACP protocol negotiation can bind to a logical port. Other ports won't bind to the logical port.

Aggregation control of LACP dynamic negotiation is supported

When a physical port is configured to bind to a logical port, the physical port with LACP negotiation can be bound to a logical port. Other ports cannot be bound to the logical port.

Flow balance of port aggregation is supported.

After port aggregation, the data flow of the aggregation port will be distributed to each aggregated physical port.

25.1.2 Port Aggregation Configuration Task

Configuring logical channel used for aggregation

Aggregation of physical port

Selecting load balance mode after port aggregation

Monitoring the concrete condition of port aggregation

25.1.2.1 Configuring Logical Channel Used to Aggregation

You should establish a logical port before binding all the physical ports together. The logical port is used to control the channel formed by these binding physical ports.

Use the following command to configure the logical channel:

Command	Description
interface port-aggregator id	Configures aggregated logical channel.

25.1.2.2 Aggregation of Physical Port

To aggregate multiple physical ports into a logical channel, you can use static aggregation or LACP protocol for negotiation.

In the case when the static aggregation is used, it is required that the link of the physical port should be up, and the VLAN attribute of aggregation port and physical port should be identical, and then this port will be aggregated to the logical channel, regardless of whether the current port accords with the conditions of port aggregation and whether the port that connects with the physical port accords with the aggregation conditions.

Prerequisites for ports to be aggregated:

- The link of the port must be up and the port should be negotiated to full-duplex mode.
- The speed of all physical ports should be same during aggregation process, that is, if there is one physical port that has been aggregated successfully, then the speed of the second physical port must be the same as the first configured one. Also the vlan attributes of all physical ports must be identical to the aggregated port.

LACP packets are exchanged between ports in these modes:

- Active—Places a port into an active negotiating state, in which the port initiates negotiations with remote ports by sending LACP packets.
- Passive—Places a port into a passive negotiating state, in which the port responds to LACP packets it receives but does not initiate LACP negotiation. In this mode, the port channel group attaches the interface to the bundle.

If both ports use Passive method, then the aggregation fails. This is because both sides will wait for the other side to launch aggregation negotiation process.

VALN attributes: PVID, Trunk attribute, vlan-allowed range and vlan-untagged range.

Use the following command to perform aggregation on the physical ports:

Command	Description
aggregator-group <i>agg-id</i> mode { lacp static }	Configures aggregation option of the physical port.

25.1.2.3 Selecting Load Balance Method after Port Aggregation

You can select the load share method to ensure that all ports can share the data traffic after the aggregation of all physical ports. The switch can provides up to six load balance strategy:

- src-mac

It is to share the data traffic according to the source MAC address, that is, the message with same MAC address attributes is to get through a physical port.

- dst-mac

It is to share the data traffic according to the destination MAC address, that is, the message with same MAC address attributes is to get through a physical port.

- both-mac

It is to share the data traffic according to source and destination MAC addresses, that is, the message with same MAC address attributes is to get through a physical port.

- src-ip

It is to share the data traffic according to the source IP address, that is, the message with same IP address attributes is to get through a physical port.

- dst-ip

It is to share the data traffic according to the destination IP address, that is, the message with same IP address attributes is to get through a physical port.

- both-ip

It is to share the data traffic according to the destination and source IP addresses, that is, the message with same IP address attributes is to get through a physical port.

Use the following command to configure load balance method:

Command	Description
aggregator-group load-balance	Configures load balance method.

25.1.2.4 Monitoring the Concrete Conditions of Port Aggregation

Use the following command to monitor port aggregation state in EXEC mode:

Command	Description
show aggregator-group	Displays port aggregation state.

Chapter 26. EAPS Configuration

26.1 Introduction of Fast Ethernet Ring Protection

26.1.1 Overview

The Ethernet ring protection protocol is a special type of link-layer protocol specially designed for constructing the ring Ethernet topology. The Ethernet protection protocol can shut down one link in a complete ring topology, preventing the data loop from forming the broadcast storm. If a link is broken, the protocol immediately resumes the link that is previously shut down. In this way, the nodes among the ring network can communicate with each other.

The ring protection protocol and STP are both used for topology control on the link layer. STP is suitable for all kinds of complicated networks, which transmits the change of network topology hop by hop. The ring protection protocol is used for ring topology and adopts the pervasion mechanism to transmit the change of network topology. Therefore, the convergence of the ring protection protocol in the ring network is better than STP. In a sound network, the ring protection protocol can resume network communication within less than 50ms.

Remark:

EAPS supports to set a switch to be a node of multiple physical ring to construct complicated topology.

26.1.2 Related Concepts of Fast Ether-Ring Protection

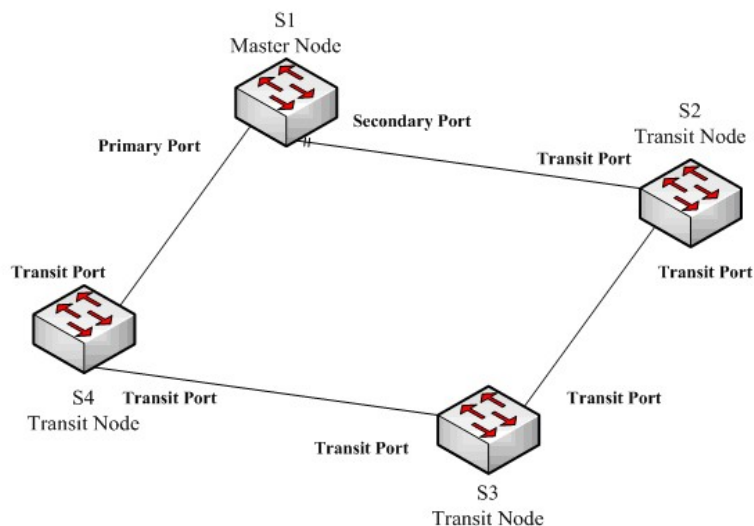

Figure 1.1 EAPS Ethernet ring

26.1.2.1 Roles of Ring's Nodes

Each switch on an Ethernet ring is a ring node. The ring nodes are classified into master nodes and transit nodes. Only one switch on the Ethernet ring can serve as a mere master node and other switches are worked

as transit nodes.

Master node: It positively knows whether the ring's topology is complete, removes loopback, control other switches to update topology information.

Transit node: It only checks the state of the local port of the ring, and notifies the master node of the invalid link.

The role of each node can be specified by user through configuration. The thing is that each switch in the same ring can be set to only one kind of node. In figure 1.1, switch S1 is the master node of ring network, while switches S2, S3 and S4 are transit nodes.

26.1.2.2 Role of the Ring's Port

EAPS demands each switch has two ports to connect the ring network. Each port of the ring network also needs to be specified through configuration and the protocol supports the following kinds of port roles:

Primary port: the primary port can be configured only on the master node. The master node transmits the ring detection packets through the primary port.

Secondary port: the secondary port can be configured only on the master node. The master node receives the ring detection packets from the secondary port and judges whether the topology of the ring network is complete. In complete topology, the master node blocks the data packets on the secondary port, and prevents loopback from occurring; after a link on the ring network is interrupted, the master node will open the secondary port to forwarding the data packets.

Transit port: the transmit port can only be configured on the transit node. Both ports through which the transit node connects the ring network are all transit ports.

Each port of the ring network can be configured as only one port role after the node's role of the switch and the control VLAN are configured. As shown in figure 1.1, the port through which master node S1 connects transit node S4 is a primary port, the port through which S1 connects S2 is a secondary port, and the ports through which other switches connect the ring network are all transit ports.

Remark:

To configure a same switch to belong to multiple rings, the switch must connect different rings through different physical ports.

26.1.2.3 Control VLAN and Data VLAN

A private control VLAN is used between master node and transit node to transmit protocol packets. This control VLAN is specified by user through configuration and ring's ports are added also by user to the control VLAN, which guarantees that the protocol packets can be normally forwarded. In general, each port of the ring network is in the forwarding state in the control VLAN and the ports which do not belong to the ring network cannot forward the packets of control VLAN.



You can specify different control VLAN for each ring on a switch. The control VLAN is only used to forward the control packets of the ring network, not for L2/L3 communication. For example, if the VLAN port that corresponds to the control

VLAN is established, the IP address of the VLAN port cannot be pinged through other devices.

The VLANs except the control VLAN are all data VLANs, which are used to transmit the packets of normal services or the management packets.



The data VLAN can be used for normal L2/L3 communication. For example, you can establish a VLAN port corresponding to data VLAN and configure dynamic routing protocols.

26.1.2.4 Aging of the MAC Address Table

The Ethernet ring protection protocol can transmit data packets to the correct link by controlling the aging of the switch's MAC address table when the topology changes. In general, the time for a MAC address to age in the MAC address table is 300 seconds. The ring protection protocol can control the aging of the MAC address table in a short time.

26.1.2.5 Symbol of a Complete Ring Network

Both the master node and the transit node can show whether the current ring network is complete through the state symbol "COMPLETE". On the master node, only when all links of the ring network are normal, the primary port is in forwarding state and the secondary port is in blocking state can the "COMPLETE" symbol be real; on the transit node, only when its two transit ports are in forwarding state can the "COMPLETE" symbol be true.

The state symbol of the ring network helps user to judge the topology state of the current network.

26.1.3 Types of EAPS Packets

The EAPS packets can be classified into the following types, as shown in table 1.1.

Table 1.1 Types of EAPS packets

Type of the packet	Remarks
Loopback detection (HEALTH)	It is transmitted by the master node to detect whether the topology of the ring network is complete.
LINK-DOWN	Indicates that link interruption happens in the ring. This kinds of packets are transmitted by the transit node.
RING-DOWN-FLUSH-FDB	It is transmitted by the master node after interruption of the ring network is detected and the packets show the MAC address aging table of the transit node.
RING-UP-FLUSH-FDB	It is transmitted by the master node after interruption of the ring network is resumed and the packets show the MAC address aging table of the transit node.

26.1.4 Fast Ethernet Ring Protection Mechanism

26.1.4.1 Ring Detection and Control of Master Node

The master node transmits the HEALTH packets to the control VLAN through the primary port in a configurable period. In normal case, the HEALTH packets will pass through all other nodes of the ring network and finally arrive at the secondary port of the master node.

The secondary port blocks all data VLANs in primitive condition. When receiving the HEALTH packets continuously, the secondary port keeps blocking data VLANs and blocking the loop. If the secondary port does not receive the HEALTH packets from the primary port in a certain time (which can be configured), it will regard the ring network is out of effect. Then the master node removes the blocking of data VLANs on the secondary port, ages the local MAC address table, and transmits the RING-DOWN-FLUSH-FDB packets to notify other nodes.

If the master node receives the HEALTH packets at the secondary port that is open to data VLANs, the ring network is resumed. In this case, the master node immediately blocks data VLANs on the secondary port, updates the local topology information and reports other nodes to age the MAC address table through RING-UP-FLUSH-FDB packets.

You can configure related commands on the Hello-time node and the Fail-time node to modify the interval for the primary port to transmit the HEALTH packets and the time limit for the secondary port to wait for the HEALTH packets.

26.1.4.2 Notification of Invalid Link of Transit Node

After the transit port of the transit node is out of effect, the LINK-DOWN packet will be immediately transmitted by the other transit port to notify other nodes. In normal case, the packet passes through other transit nodes and finally arrives at one port of the master node.

After the master node receives the LINK-DOWN packet, it thinks that the ring network is invalid. In this case, the master node removes the blocking of data VLANs on its secondary port, ages the local MAC address table, transmits the RING-DOWN-FLUSH-FDB packet and notifies other nodes.

26.1.4.3 Resuming the Link of the Transit Node

After the transit port is resumed, it does not immediately transmit the packets of data VLANs, but enters the Pre-Forwarding state. A transit port in pre-forwarding state only transmits and receives the control packets from the control VLAN.

If there is only one transit port invalid in the ring network and when the port enters the pre-forwarding state, the secondary port of the master node can receive the HEALTH packet from the primary port again. In this case, the master node blocks data VLANs on the secondary port again and transmits the notification of ageing address table outside. After the node with a transit port in pre-forwarding state receives the notification of aging address table, the node will first modify the pre-forwarding port to the forwarding port and then ages the local MAC address table.

If a transit mode does not receive the notification of aging address table from the master node, it thinks that the link to the master node is already out of effect, the transit node will automatically set the pre-forwarding port to be a forwarding one.

You can configure the related commands through the pre-forward-time node to modify the time for the transit port to keep the pre-forwarding state.

26.2 Fast Ethernet Ring Protection Configuration

26.2.1 Default EAPS Settings



The fast Ethernet protection protocol cannot be set together with STP.

After STP is disabled, you are recommended to run **spanning-tree bpduterminal** to keep the ring node from forwarding BPDUs, which leads to the storm.

See the following table:

Table 2.1 Default settings of the Ethernet ring protection protocol and STP.

Spanning tree protocol	spanning-tree mode rstp
Fast Ethernet Ring Protection	There is no configuration.

26.2.2 Requisites before Configuration

Before configuring MEAPS, please read the following items carefully:

- One of important functions of the ring protection protocol is to stop the broadcast storm, so please make sure that before the ring link is reconnected all ring nodes are configured. If the ring network is connected in the case that the configuration is not finished, the broadcast storm may easily occur.
- EAPS is well compatible with STP, but the port under the control of EAPS is not subject to STP.
- The ring protection protocol supports a switch to configure multiple ring networks.
- Configuring ring control VLAN will lead to the automatic establishment of corresponding system VLAN.
- The port of each ring can forward the packets from the control VLAN of the ring, while other ports, even in the Trunk mode, cannot forward the packets from the control VLAN.
- By default, Fail-time of the master node is triple longer than Hello-time, so that packet delay is avoided from shocking the ring protection protocol. After Hello-time is modified, Fail-time need be modified accordingly.
- By default, Pre-Forward-Time of the transit node is triple longer than Hello-time of the master node so that it is ensured that the master node can detect the recovery of the ring network before the transit port enters the pre-forwarding state. If Hello-time configured on the master node is longer than Pre-Forward-Time of the transit node, loopback is easily generated and broadcast storm is then

triggered.

- The physical interface, the fast-Ethernet interface, the gigabit-Ethernet interface and the aggregation interface can all be set to be the ring's interfaces. If link aggregation, 802.1X or port security has been already configured on a physical interface, the physical interface cannot be set to be a ring's interface any more.



The versions of switch software prior to version 2.0.1L and the versions of hi-end switch software prior to version 4.0.0M do not support the configuration of the converged port.

26.2.3 MEAPS Configuration Tasks

- Configuring the Master Node
- Configuring the Transit Node
- Configuring the Ring Port
- Browsing the State of the Ring Protection Protocol

26.2.4 Fast Ethernet Ring Protection Configuration

26.2.4.1 Configuring the Master Node

Configure a switch to be the master node of a ring network according to the following steps:

Command	Purpose
Switch#config	Enters the switch configuration mode.
Switch_config#ether-ring <i>id</i>	Sets a node and enters the node configuration mode. id: Instance ID
Switch_config_ring#control-vlan <i>vlan-id</i>	Configures the control VLAN. Vlan-id: ID of the control VLAN
Switch_config_ring#master-node	Configures the node type to be a master node.
Switch_config_ring#hello-time <i>value</i>	This step is optional. Configures the cycle for the master node to transmit the HEALTH packets. Value: It is a time value ranging from 1 to 10 seconds and the default value is 1 second.
Switch_config_ring#fail-time <i>value</i>	This step is optional. Configures the time for the secondary port to wait for the HEALTH packets. Value: It is a time value ranging from 3 to 30 seconds and the default value is 3 second.
Switch_config_ring#exit	Saves the current settings and exits the

	node configuration mode.
--	--------------------------

Remarks:

The `no ether-ring id` command is used to delete the node settings and port settings of the Ethernet ring.

26.2.4.2 Configuring the Transit Node

Configure a switch to be the transit node of a ring network according to the following steps:

Command	Purpose
Switch#config	Enters the switch configuration mode.
Switch_config#ether-ring <i>id</i>	Sets a node and enters the node configuration mode. id: Instance ID
Switch_config_ring#control-vlan <i>vlan-id</i>	Configures the control VLAN. Vlan-id: ID of the control VLAN
Switch_config_ring#transit-node	Configures the node type to be a transit node.
Switch_config_ring#pre-forward-time <i>value</i>	This step is optional. Configures the time of maintaining the pre-forward state on the transit port. Value: It is a time value ranging from 3 to 30 seconds and the default value is 3 second.
Switch_config_ring#exit	Saves the current settings and exits the node configuration mode.

26.2.4.3 Configuring the Ring Port

Configure a port of a switch to be the port of Ethernet ring according to the following steps:

Command	Purpose
Switch#config	Enters the switch configuration mode.
Switch_config#interface <i>intf-name</i>	Enters the interface configuration mode. intf-name: Stands for the name of an interface.
Switch_config_intf#ether-ring <i>id</i> {primary-port secondary-port transit-port }	Configures the type of the port of Ethernet ring. ID of the node of Ethernet ring
Switch_config_intf#exit	Exits from interface configuration mode.

Remarks:

The `no ether-ring id primary-port { secondary-port | transit-port }` command can be used to cancel the port settings of Ethernet ring.

26.2.4.4 Browsing the State of the Ring Protection Protocol

Run the following command to browse the state of the ring protection protocol:

Command	Purpose
show ether-ring <i>id</i>	Browses the summary information about the ring protection protocol and the port of Ethernet ring. id: ID of Ethernet ring
show ether-ring <i>id</i> detail	Browses the detailed information about the ring protection protocol and the port of Ethernet ring.
show ether-ring <i>id</i> interface <i>intf-name</i>	Browses the state of the Ether-ring port or that of the common port.

26.2.5 MEAPS configuration

26.2.5.1 Configuration Example

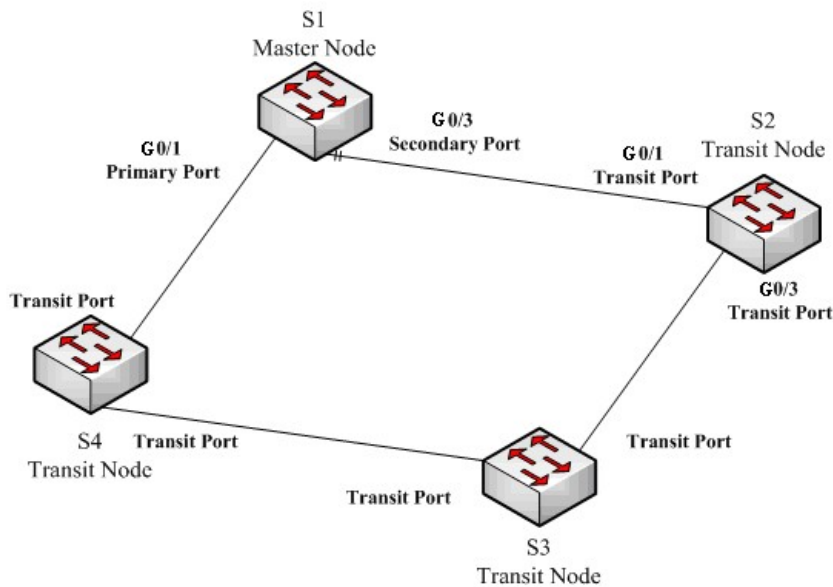

MEAPS configuration

As shown in figure 2.1, master node S1 and transit node S2 are configured as follows. As to the settings of other nodes, they are same to S2's settings.

Configuring switch S1:

Shuts down STP and configures the Ether-ring node:

```
S1_config#no spanning-tree
```

```
S1_config#ether-ring 1
```

```
S1_config_ring1#control-vlan 2
```

```
S1_config_ring1#master-node
```

The following commands are used to set the time related parameters:

```
S1_config_ring1#hello-time 2
```

```
S1_config_ring1#fail-time 6
```

Exits from the node configuration mode:

```
S1_config_ring1#exit
```

Configures the primary port and the secondary port:

```
S1_config#interface gigaEthernet 0/1
```

```
S1_config_g0/1#ether-ring 1 primary-port
```

```
S1_config_g0/1#exit
```

```
S1_config#interface gigaEthernet 0/3
```

```
S1_config_g0/3#ether-ring 1 secondary-port
```

```
S1_config_g0/3#exit
```

Establishes the control VLAN:

```
S1_config#vlan 2
```

```
S1_config_vlan2#exit
```

```
S1_config#interface range g0/1 , 3
```

```
S1_config_if_range#switchport mode trunk
```

```
S1_config_if_range#exit
```

Configuring switch S2:

```
S1_config#no spanning-tree
```

```
S1_config#ether-ring 1
```

```
S1_config_ring1#control-vlan 2
```

```
S1_config_ring1#transit-node
```

```
S1_config_ring1#pre-forward-time 8
```

```
S1_config_ring1#exit
```

```
S1_config#interface gigaEthernet 0/1
```

```
S1_config_g0/1#ether-ring 1 transit-port
```

```
S1_config_g0/1#exit
```

```
S1_config#interface gigaEthernet 0/3
```

```
S1_config_g0/3#ether-ring 1 transit-port
```

```
S1_config_g0/3#exit
```

```
S1_config#vlan 2
```

```
S1_config_vlan2#exit
```

```
S1_config#interface range gigaEthernet 0/1 , 3
```

```
S1_config_if_range#switchport mode trunk
```

```
S1_config_if_range#exit
```

Chapter 27. MEAPS Settings

27.1 MEAPS Introduction

27.1.1 MEAPS Overview

EAPS is a protocol specially applied on the link layer of the Ethernet ring. When the Ethernet ring is complete, you should prevent the broadcast storm from occurring on the data loopback. But when a link of an Ethernet ring is broken, you should enable the backup link rapidly to resume the communication of different nodes in the ring. The role of switch is specified by you through configuration.

EAPS only supports the single-ring structure, while MEAPS, an expansion on the basis of EAPS, can support not only the single ring but also the level-2 multi-ring structure. The later structure consists of the aggregation layer in the middle, constructed by aggregation equipment through the Ethernet ring for fast switching, and the access layer at the outside, connected by the access equipment. Different levels of rings are connected through the tangency or intersection mode. See the specific topology in the following figure:

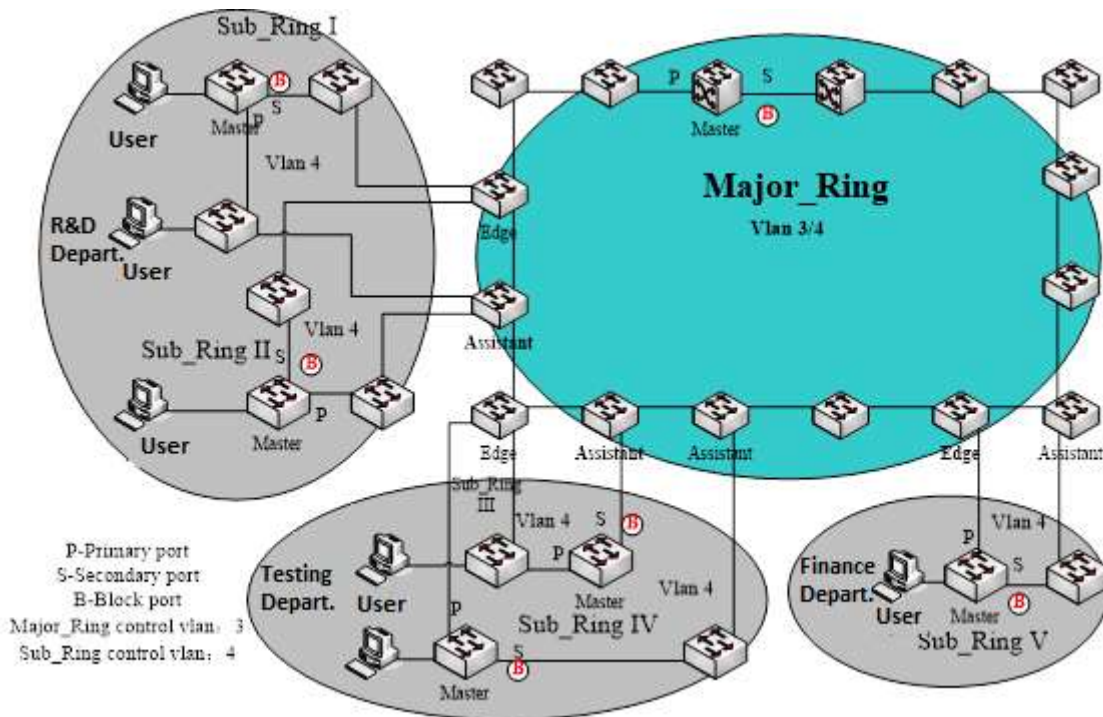

Figure 1: MEAPS topology

The ring protection protocol and STP are both used for topology control on the link layer. STP is suitable for all kinds of complicated networks, which transmits the change of network topology hop by hop. The ring protection protocol is used for ring topology and adopts the pervasion mechanism to transmit the change of network topology. Therefore, the convergence of the ring protection protocol in the ring network is better than STP. In a sound network, the ring protection protocol can resume network communication within less than 50ms.

27.1.2 Basic Concepts of MEAPS

27.1.2.1 Domain

The domain specifies the protection range of the Ethernet loopback protection protocol and is marked by ID, which consists of integers; A group of switches that support the same protection data and have the same control VLAN can form a domain after they are connected with each other. One domain may include only one ring or multiple rings that intersect each other. See the following figure.

One MEAPS domain has the following factors: MEAPS ring, control VLAN, master node, transit node, edge node and assistant edge node.

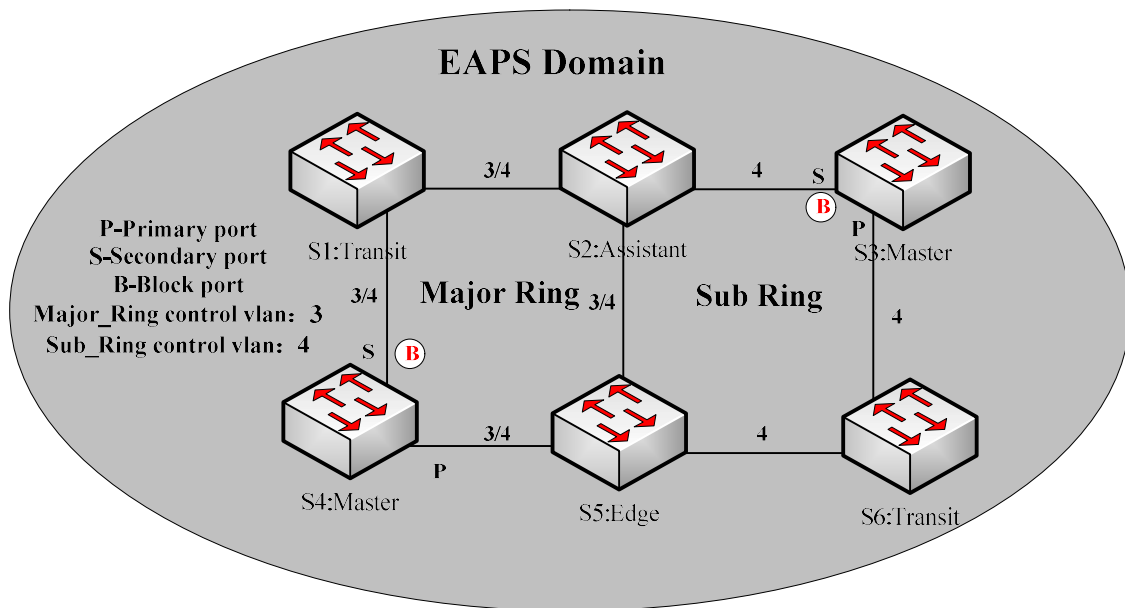

Figure 2: Simple MEAPS model

27.1.2.2 Ring

One ring corresponds to an ring Ethernet topology physically, which is a group of switches that are connected each other into a ring. One MEAPS domain may include only one MEAPS ring or multiple rings that intersect each other.

27.1.2.3 Major Ring

When a domain includes many rings, you should choose one ring from them as a major ring. The primary and secondary ports of each node on the major ring should be added into the main control VLAN and the sub control VLAN at the same time. See the following figure.

27.1.2.4 Sub Ring

When a domain includes many rings, the included rings except the major ring are called as sub rings. The primary and secondary ports of each node on the sub ring should be added into the sub control VLAN. See the following figure.

27.1.2.5 Control VLAN

The control VLAN is a concept against the data VLAN, and in MEAPS, the control VLAN is just used to transmit the MEAPS packets. Each MEAPS has two control VLANs, that is, the main control VLAN and the sub control VLAN.

You need to specify the main control VLAN when configuring the major ring or the sub ring. During configuration you just need to specify the main control VLAN and take a VLAN, the ID of which is 1 more than the ID of the main control VLAN, as the sub control VLAN. The major ring will be added to the main control VLAN and the sub control VLAN at the same time, while the sub ring will only be added to the sub control VLAN. See number 3 and number 4 beside each port on figure 2.

The main-ring protocol packets are transmitted in the main control VLAN, while the sub-ring protocol packets are transmitted in the sub control VLAN. The sub control VLAN on the major ring is the data VLAN of the major ring. The ports of a switch that access the Ethernet ring belong to the control VLAN, and only those ports that access the Ethernet ring can be added into the control VLAN.

Remarks:

The MEAPS port of the major ring should belong to both the main control VLAN and the sub control VLAN; the MEAPS port of the sub ring only belongs to the sub control VLAN. The major ring is regarded as a logical node of the sub ring and the packets of the sub ring are transparently transmitted through the major ring; the packets of the major ring are transmitted only in the major ring.

27.1.2.6 Data VLAN

The data VLAN is used to transmit data packets. The data VLAN can include the MEAPS port and the non-MEAPS port. Each domain protects one or multiple data VLANs. The topology that is calculated by the ring protection protocol in a domain is effective only to the data VLAN in this domain.

Whether the data VLAN is created or not has no influence on the work of the ring state machine, where the MEAPS port is controlled by the MEAPS module and the non-MEAPS port is controlled by the STP module.

Remarks:

The processing methods which are similar to that of the MSTP module can be used, that is, the status of a port in the default STP instance is decided by the link status of the port, no matter what the VLAN configuration of a port is.

27.1.2.7 Master Node

The master node works as policy making and control of a ring. Each ring must possess only one master node. The master node takes active attitude to know whether the ring's topology is complete, removes loopback, control other switches to update topology information. See the following figure, where S3 is the master node of the sub ring and S4 is the master node of the major ring.

27.1.2.8 Transit Node

All switches on the Ethernet except the master node can be called as the transit nodes. The transit node only checks the state of the local port of the ring, and notifies the master node of the invalid link. See the following figure, in which S1, S2, S5 and S6 are all transit nodes.

27.1.2.9 Edge Node and Assistant Node

When the sub ring and the major ring are intersected, there are two intersection points, two switches beside which are called as the edge node for one and the assistant node for the other. The two nodes are both the nodes of the sub ring. There are no special requirements as to which switch will be set to be the edge node or the assistant node if their configurations can distinguish themselves. However, one of them must be set as the edge node and the other must be set as the assistant node. The edge node or the assistant node is a role that a switch takes on the sub ring, but the switch takes a role of the transit node or the master node when it is on the major ring. See the following figure, in which S2 is the assistant node and S5 is the edge node.

27.1.2.10 Primary Port and Secondary Port

The two ports through which the master node accesses the Ethernet ring are called as the primary port and the secondary port. The roles of the two ports are decided by the clients.

The primary port is in forwarding state when it is up. Its function is to forward the packets of the data VLAN on the master node and to receive and forward the control packets on the control VLAN. The master node will transmit the loopback detection packets from the primary port to the control VLAN. If the link of the primary port is resumed from the invalid status, the master node requires sending the address aging notification to the control VLAN promptly and then starts to transmit the loopback detection packets from the primary port.

The secondary port is in forwarding or blocking state when it is up. The master node receives the ring detection packets from the secondary port and judges whether the topology of the ring network is complete. In complete topology, the master node blocks the data packets on the secondary port, and prevents loopback from occurring; after a link on the ring network is interrupted, the master node will open the secondary port to forwarding the data packets.

Remarks:

A port can be set as the primary port or the secondary port of a node and it cannot be set to be both the primary port and the secondary port.

27.1.2.11 Transit Port

The two ports for the transit node to access the Ethernet ring are both transit ports. Users can decide the role of the two ports through configuration.

The transit port is in forwarding or pre-forwarding state when it is up. A transit port receives the control packets from the control VLAN and at the same time forwards these packets to other ports in the control VLAN. After the transit port resumes from the invalid state, it first enters the pre-forwarding state, receives and forwards

only the control packets, and blocks the data VLAN. After the transit node receives the notification of the aging address table, it enters the forwarding state.

Remarks:

A port can be set as the primary port or the transit port of a node and it cannot be reset.

27.1.2.12 Common Port and Edge Port

The edge node and the assistant node are the places where the sub ring and the major ring intersect. As to the two ports that access the Ethernet, one is a common port, which is the public port of the sub ring and the major ring; the other is the edge port in the sub ring. The roles of the two ports are decided by users through configuration.

The common port is on the main-ring port and so its state is decided by the state of the main-ring port. The common port itself has no operations or notifications. When the link, connecting the common port, changes, the sub-ring node where the common port lies will not be notified. The existence of the common port just guarantees the completeness of the ring.

The edge port of the edge node is in forwarding or preforwarding state when it is up. Its basic characteristics are consistent with those of the transit port except one function. The exceptional function is that when the edge port is up and its corresponding main-ring port is also up, it will transmit the edge-hello packets from the main-ring port to detect the completeness of the major ring.

The edge port of the assistant node is in forwarding, pre-forwarding or EdgePreforwarding state when it is up. Besides the same characteristics of the transit port, it also has one more state, the EdgePreforwarding state. If the edge port is in forwarding state and the main-ring port that the edge port corresponds to has not received the edge-hello packets, the state of the edge port is changed into the EdgePreforwarding state, and it only receives and forwards the control packets and blocks the data VLAN until the corresponding main-ring port receives the Edge-hello packets again.

The edge port of the edge node and the assistant node is to help detect the completeness of the major ring. For more details, see the channel status checkup mechanism of the sub-ring protocol packets on the major ring in the following chapter.

Remarks:

Each port can be set as the only edge port of a node and it cannot be configured again; the common port can be borne only on a port of the major ring and it cannot be configured on a port without a corresponding main-ring port.

27.1.2.13 FLUSH MAC FDB

The Ethernet ring protection protocol can transmit data packets to the correct link by controlling the aging of the switch's MAC address table when the topology changes. In general, the time for a MAC address to age in the MAC address table is 300 seconds. The ring protection protocol can control the aging of the MAC address table in a short time.

27.1.2.14 Complete Flag of Ring

Both the master node and the transit node can show whether the current ring network is complete through the state symbol "COMPLETE". On the master node, only when all links of the ring network are normal, the primary port is in forwarding state and the secondary port is in blocking state can the "COMPLETE" symbol be real; on the transit node, only when its two transit ports are in forwarding state can the "COMPLETE" symbol be true.

The state symbol of the ring network helps user to judge the topology state of the current network.

27.1.3 Types of EAPS Packets

The EAPS packets can be classified into the following types, as shown in table 1.1.

Table 1.1 Types of EAPS packets

Type of the packet	Remarks
HEALTH	It is transmitted by the master node to detect whether the topology of the ring network is complete.
LINK-DOWN	Indicates that link interruption happens in the ring. This kinds of packets are transmitted by the transit node.
RING-DOWN-FLUSH-FDB	It is transmitted by the master node after interruption of the ring network is detected and the packets show the MAC address aging table of the transit node.
RING-UP-FLUSH-FDB	It is transmitted by the master node after interruption of the ring network is resumed and the packets show the MAC address aging table of the transit node.
EDGE-HELLO	It is decided by the edge port of the edge node, transmitted by the main-ring port that the edge node corresponds to, and detects whether the major ring is complete.

27.1.4 Fast Ethernet Ring Protection Mechanism

27.1.4.1 Polling mechanism

The primary port transmits the HEALTH packets to the control VLAN. In normal case, the HEALTH packets will pass through all other nodes of the ring and finally arrive at the secondary port of the master node. The secondary port blocks all data VLANs in primitive condition. When receiving the HEALTH packets continuously, the secondary port keeps blocking data VLANs and blocking the loop. If the secondary port does not receive the HEALTH packets from the primary port in a certain time (which can be configured), it will regard the ring network is out of effect. Then the master node removes the blocking of data VLANs on the secondary port, ages the local MAC address table, and transmits the RING-DOWN-FLUSH-FDB packets to

notify other nodes.

If the master node receives the HEALTH packets at the secondary port that is open to data VLANs, the ring network is resumed. In this case, the master node immediately blocks data VLANs on the secondary port, updates the local topology information and reports other nodes to age the MAC address table through RING-UP-FLUSH-FDB packets.

As shown in the following figure, the master node, S4, transmits the HELLO packets periodically. If the loopback has no troubles, the HELLO packets will arrive at the secondary port of the master node, and the master node will block data forwarding of the data VLAN that the secondary port belongs to, preventing the loopback from happening.

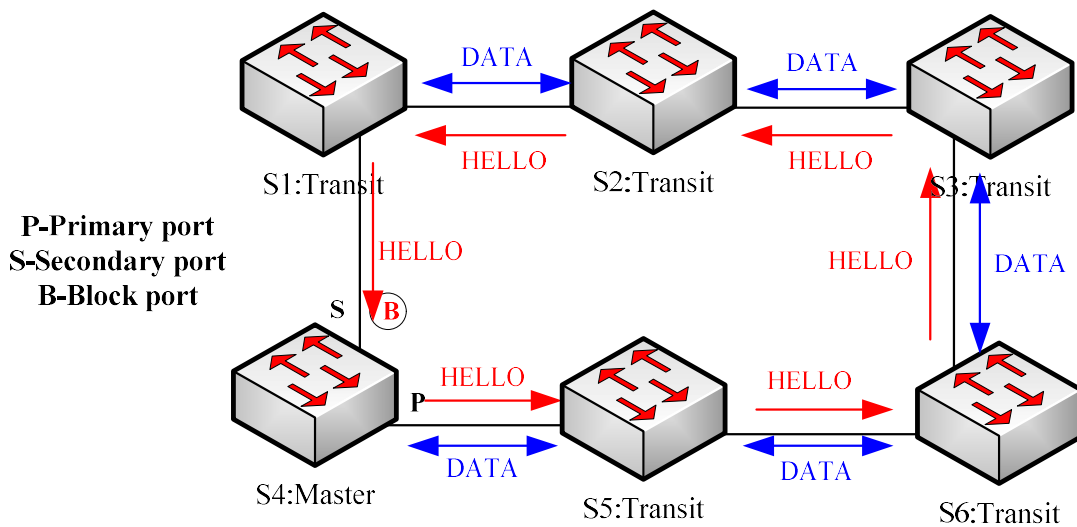

Figure 3: Polling

Remarks:

You can configure related commands on the Hello-time node and the Fail-time node to modify the interval for the primary port to transmit the HEALTH packets and the time limit for the secondary port to wait for the HEALTH packets.

27.1.4.2 Notification of Invalid Link of Transit Node

Link state notification is a mechanism faster than the polling mechanism to change the ring topology:

After the transit port of the transit node is out of effect, the LINK-DOWN packet will be immediately transmitted by the other transit port to notify other nodes. In normal case, the packet passes through other transit nodes and finally arrives at one port of the master node.

After the master node receives the LINK-DOWN packet, it thinks that the ring network is invalid. In this case, the master node removes the blocking of data VLANs on its secondaryport, ages the local MAC address table, transmits the RING-DOWN-FLUSH-FDB packet and notifies other nodes. As shown in the following figure, trouble occurs on the link between node S3 and node S6. After node S3 and node S6 detect that trouble has already occurred on the link, they block the ports that the troubled link corresponds to and transmit the LINK-DOWN packets respectively from the other port; when the master node receives the LINK-DOWN

packets, holds that the trouble occurs on the loopback, and decides not to wait for the fail-time any more.

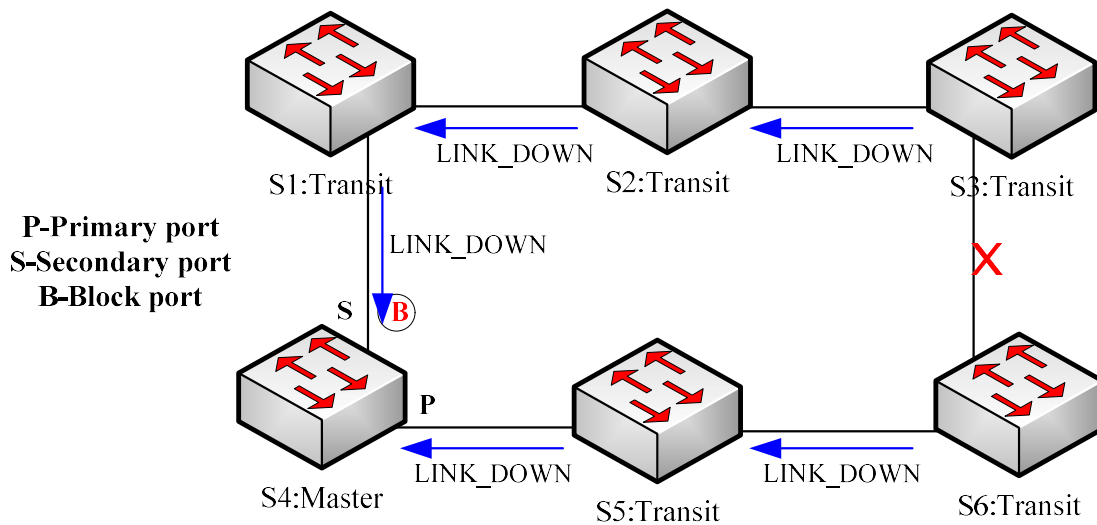

Figure 4: Link status change notification

After the transit port is resumed, it does not immediately transmit the packets of data VLANs, but enters the Pre-Forwarding state. A transit port in pre-forwarding state only transmits and receives the control packets from the control VLAN.

If there is only one transit port invalid in the ring network and when the port enters the pre-forwarding state, the secondary port of the master node can receive the HEALTH packet from the primary port again. In this case, the master node blocks data VLANs on the secondary port again and transmits the notification of ageing address table outside. After the node with a transit port in pre-forwarding state receives the notification of ageing address table, the node will first modify the pre-forwarding port to the forwarding port and then ages the local MAC address table.

If a transit mode does not receives the notification of ageing address table from the master node, it thinks that the link connecting the master node is already out of effect, and the transit node will automatically set the pre-forwarding port to be a forwarding one.

Remarks:

You can configure the related commands through the pre-forward-time node to modify the time for the transit port to keep the pre-forwarding state.

27.1.4.3 Channel Status Checkup Mechanism of the Sub-Ring Protocol Packet on the Major ring

The ports on the major ring are simultaneously added to the control VLAN of the major ring and the control VLAN of the sub ring. Hence, the protocol packets of the sub ring should be broadcast among the edge ports of the edge node and the assistant node through the channel, provided by the major ring. In this case, the whole major ring is just like a node of the sub ring (similar as a virtual transit node), as shown in the following figure:

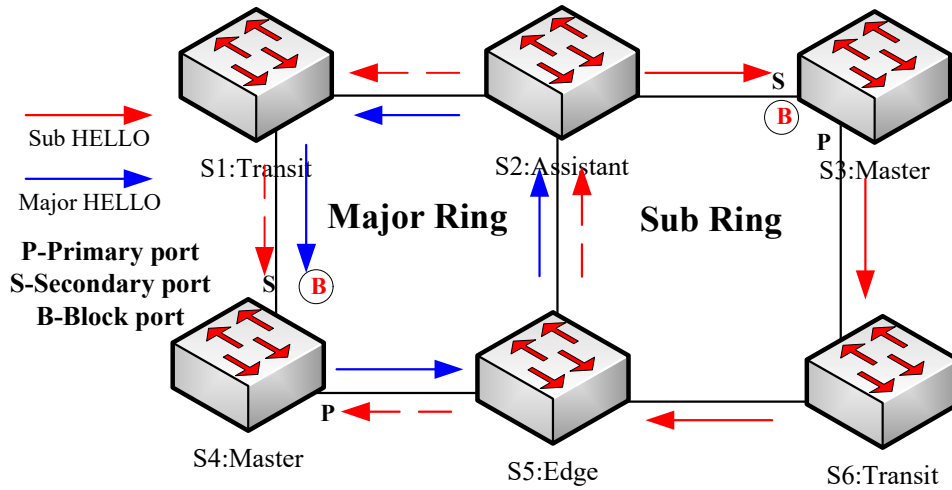

Figure 5: Intersection of the major ring and the sub ring

When trouble occurs on the link of the major ring, and when the channel of the sub-ring protocol packets between the edge node and the assistant node are interrupted, the master node of the sub ring cannot receive the HELLO packets that the master node itself transmits. In this case, the Fail Time times out, and the master node of the sub ring changes to the Failed state and opens its secondary port.

The above-mentioned processes have an effective protection towards general networking, guaranteeing not only the prevention of the broadcast loopback but also the corresponding functions of the backup link. The dual homing networking mode is always used in actual networking, as shown in the following figure. The two sub rings in the dual homing networking, sub ring I and sub ring II, interconnect through the edge node and assistant node, and forms a big ring. When the major ring has troubles, the secondary ports of the master nodes of all sub rings open and forms the broadcast loop (marked by the arrow) in the big ring.

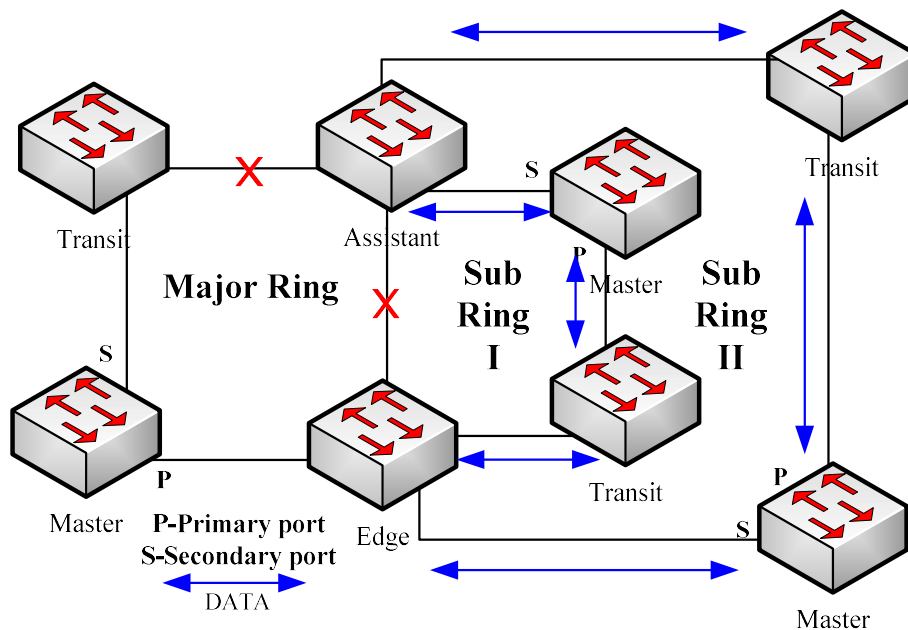

Figure 6: Broadcast storm triggered by the dual homing networking mode

The channel status checkup mechanism of the sub-ring protocol packet on the major ring is introduced to

solve the problem about the dual homing ring. This mechanism is to monitor the status of the channel link on the major ring between the edge node and the assistant node, which requires the help of the edge node and the assistant node. The purpose of this mechanism is to keep the data loop from happening by blocking the edge port of the edge node before the secondary port of the master node on the sub ring opens. The edge node is the trigger of the mechanism, while the assistant node is the listener and decider of this mechanism. Once the notification message from the edge node cannot be received, the edge node will instantly be in blocked state until this notification message is received again. The results of the mechanism, which bring about after the troubles on the major ring, are shown in the following figure:

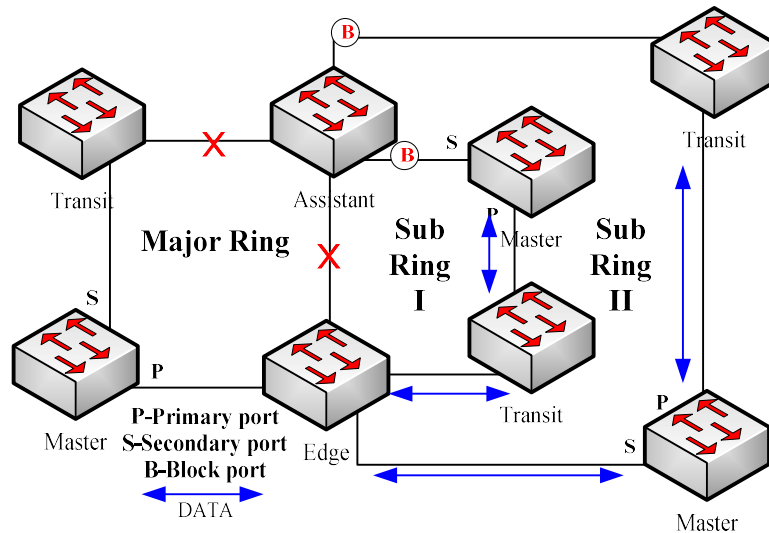

Figure 7: Results of the channel status checkup mechanism

But you should pay special attention to this point that the edge port of the assistant node must be blocked before the secondary port of the master node on the sub ring opens. Otherwise, the broadcast storm will happen.

The whole procedure of this mechanism is described as follows:

1. Check the channel status on the major ring between the edge node and the assistant node.

The edge node of the sub ring periodically transmits the Edge-Hello packets to the major ring through the two ports of the major ring, and these packets pass through all nodes on the major ring in sequence and finally arrive the assistant node, as shown in the following figure. If the assistant node can receive the edge-hello packet in the regulated time, it indicates that the channel of this packet is normal; if not, it indicates that the channel is interrupted. The edge-hello packet is the control packet of the sub ring, but is transmitted and received by the ports on the major ring and is transferred to the sub ring for processing.

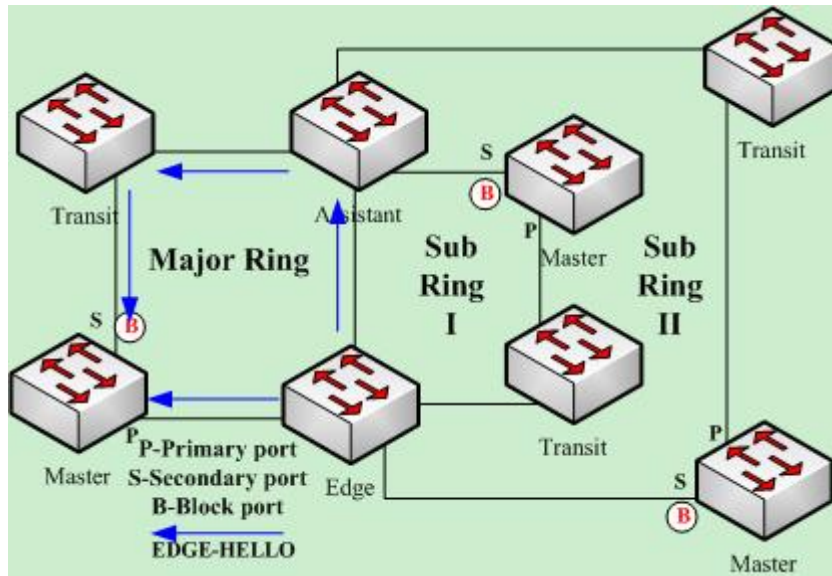

Figure 8. Check the channel status on the major ring between the edge node and the assistant node.

2. The edge node blocks the edge port at the interruption of the channel.

If the assistant node cannot receive the edge-hello packet during Edge Fail Time, the assistant holds that the channel of the sub-ring protocol packet—the edge-hello packet—is interrupted, changes its edge port's status into the Edge-Preforwarding status instantly, blocks the forwarding of the data packets (though still receives and forwards the control packet), and immediately transmits the LINK-DOWN packet to the master node for the master node to open the secondary port to avoid communication interruption among all nodes on the ring.

Remarks:

In order to guarantee that the edge port first changes into the edge-preforwarding status and then the master node opens the secondary port, you shall be sure that the cycle for the edge node to transmit the edge-hello packet, Edge Hello Time, is smaller than the cycle for the master node to transmit the Hello packet, Hello Time; similarly, the Edge Fail Time of the assistant node should be smaller than Fail Time. At the same time, Fail Time is generally the triple of Hello Time, and Edge Fail Time is also the triple of Edge Hello Time.

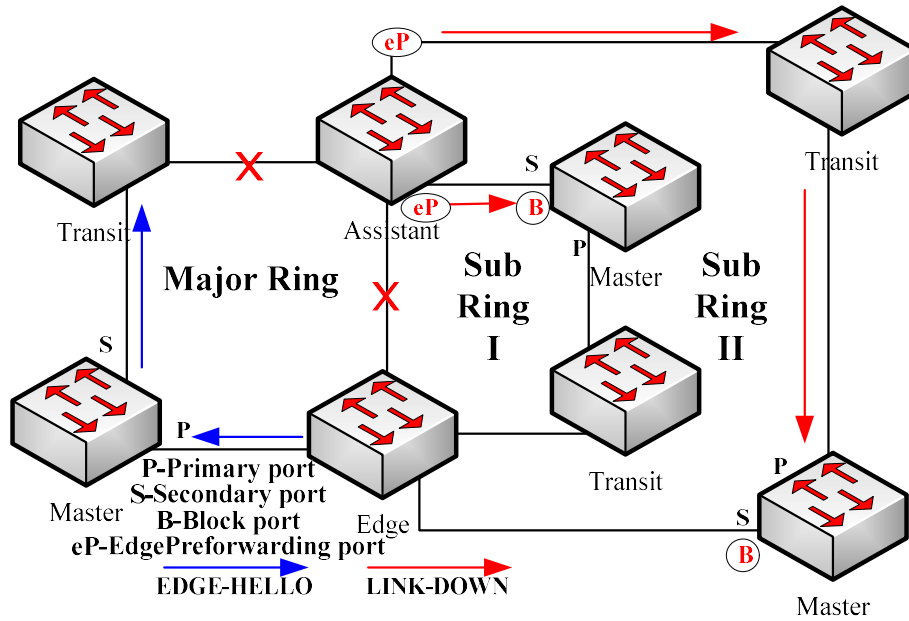

Figure 9: The edge node blocks the edge port at the interruption of the channel.

3. Channel recovery

When the link of the major ring and the communication between the edge node and the assistant node resumes, the channel of the sub-ring protocol packet resumes to the normal function. In this case, the master node of the sub ring receives the Hello packet again, which is transmitted by the master node itself, and therefore it switches to the Complete status, blocks the secondary port and transmits the RING-UP-FLUSH-FDB packet to the ring. At the same time, the status of the edge port of the assistant node changes from Edge-Preforwarding to Forwarding, guaranteeing a smooth communication among all nodes on the ring. The following figure shows that the channel is resumed and then the communication on the ring is also resumed.



Before the edge node opens the blocked edge port, the secondary port of the master node on the sub ring should be blocked to prevent the broadcast storm from happening.

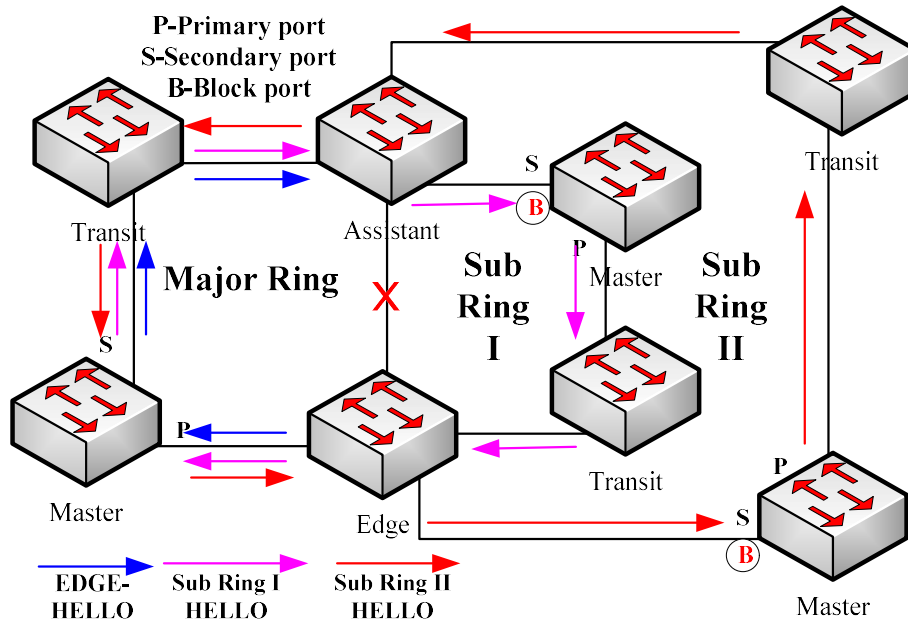

Figure 10: Channel recovery

27.2 Fast Ethernet Ring Protection Configuration

27.2.1 Requisites before Configuration

Before configuring MEAPS, please read the following items carefully:

- One of important functions of the ring protection protocol is to stop the broadcast storm, so please make sure that before the ring link is reconnected all ring nodes are configured. If the ring network is connected in the case that the configuration is not finished, the broadcast storm may easily occur.
- Set the ring protection protocol to realize the compatibility of STP. The users are allowed to set “no spanning-tree”, SSTP, RSTP and MSTP.
- After an instance of the ring's node is set, users are forbidden to change the basic information of the node (excluding the time parameters) unless the current ring's node is deleted and then reset.
- If you run **show** to browse the configured node and find its state is **init**, it shows that the node's configuration is unfinished and therefore the node cannot be started. In this case, you are required to change or add basic information to complete the configuration of the node.
- The ring protection protocol supports a switch to configure multiple ring networks.
- The configuration of the control VLAN of the ring network does not automatically establish the corresponding systematic VLAN. You need to establish the systematic VLAN manually through global VLAN configuration command.
- The port of each ring can forward the packets from the control VLAN of the ring, while other ports, even in the Trunk mode, cannot forward the packets from the control VLAN.
- By default, Fail-time of the master node is triple longer than Hello-time, so that packet delay is avoided from shocking the ring protection protocol. After Hello-time is modified, Fail-time need be modified accordingly.

- By default, Pre-Forward-Time of the transit node is triple longer than Hello-time of the master node so that it is ensured that the master node can detect the recovery of the ring network before the transit port enters the pre-forwarding state. If Hello-time configured on the master node is longer than Pre-Forward-Time of the transit node, loopback is easily generated and broadcast storm is then triggered.
- Users cannot set Edge Hello Time and Edge Fail Time, and their default values are decided by Hello Time and Fail Time respectively for their values are 1/3 of Hello Time and Fail Time respectively.
- The physical interface, the fast-Ethernet interface, the gigabit-Ethernet interface and the aggregation interface can all be set to be the ring's interfaces. If link aggregation, 802.1X or port security has been already configured on a physical interface, the physical interface cannot be set to be a ring's interface any more.
- This protocol is similar with the original EAPS in functions, but its ring's topology has more expansibility and flexibility. Hence, MEAPS and EAPS are partially compatible, and the intersection configuration can be done on the MEAPS ring and the EAPS ring. But a same physical port cannot be simultaneously set to support MEAPS and EAPS.

27.2.2 MEAPS Configuration Tasks

- Configuring the Master Node
- Configuring the Transit Node
- Configuring the Edge Node and the Assistant Node
- Configuring the Ring Port
- Browsing the State of the Ring Protection Protocol

27.2.3 Fast Ethernet Ring Protection Configuration

27.2.3.1 Configuring the Master Node

Configure a switch to be the master node of a ring network according to the following steps:

Command	Purpose
Switch# config	Enters the switch configuration mode.
Switch_config# mether-ring id1 domain/id2	Sets a node and enters the node configuration mode. <i>id1</i> : instance ID of a node <i>id2</i> : instance ID of a domain (omitted when it is 0)
Switch_config_ring1# master-node	It is an obligatory step. Configures the node type to be a master node.
Switch_config_ring1# major-ring[sub-ring]	It is an obligatory step. Sets the node's level to be one of the major or sub ring node.
Switch_config_ring1# control-vlan/vlan-id	It is an obligatory step. Sets the control VLAN and

	establishes VLAN “id” and VLAN “id-1”. <i>vlan-id:</i> ID of the control VLAN
Switch_config_ring1# hello-timevalue	This step is optional. Configures the cycle for the master node to transmit the HEALTH packets. <i>value:</i> It is a time value ranging from 1 to 10 seconds and the default value is 3 seconds.
Switch_config_ring1# fail-timevalue	This step is optional. Configures the time for the secondary port to wait for the HEALTH packets. <i>value:</i> It is a time value ranging from 3 to 30 seconds and the default value is 9 seconds.
Switch_config_ring1# exit	Saves the current settings and exits the node configuration mode.
Switch_config#	

Remarks:

The no mether-ring *iddomainid2* command is used to delete the node settings and the node’s port settings of the ring.

Remarks:

During configuration, both the major ring and the sub-ring should be set to have the same control VLAN—the control VLAN of the major ring. After this configuration is successfully set, the control VLAN of major ring and the control VLAN of sub-ring are created on the major ring, and at the same time the sub-ring control VLAN is created on the sub-ring and the major-ring control VLAN is forbidden on the sub-ring.

27.2.3.2 Configuring the Transit Node

Configure a switch to be the transit node of a ring network according to the following steps:

Command	Purpose
Switch# config	Enters the switch configuration mode.
Switch_config# mether-ring id1 domainid2	Sets a node and enters the node configuration mode. <i>id1:</i> instance ID of a node <i>id2:</i> instance ID of a domain (omitted when it is 0)
Switch_config_ring1# transit -node	It is an obligatory step. Configures the node type to be a transit node.
Switch_config_ring1# major-ring[sub-ring]	It is an obligatory step. Sets the node’s level to be one of the major or sub ring node.
Switch_config_ring1# control-vlanvlan-id	It is an obligatory step. Sets the control VLAN and

	establishes VLAN “id” and VLAN “id-1”. <i>vlan-id</i> : ID of the control VLAN
Switch_config_ring1#pre-forward-timevalue	This step is optional. Configures the time of maintaining the pre-forward state on the transit port. <i>value</i> : It is a time value ranging from 3 to 30 seconds and the default value is 9 seconds.
Switch_config_ring#exit	Saves the current settings and exits the node configuration mode.
Switch_config#	

27.2.3.3 Configuring the Edge Node and the Assistant Node

Configure a switch to be the master node of a ring network according to the following steps:

Command	Purpose
Switch# config	Enters the switch configuration mode.
Switch_config# mether-ring id1 domainid2	Sets a node and enters the node configuration mode. <i>id1</i> : instance ID of a node <i>id2</i> : instance ID of a domain (omitted when it is 0)
Switch_config_ring1# edge-node[assistant-node]	It is an obligatory step. Sets the node type to be an edge node.
Switch_config_ring1# sub-ring	This step can be omitted. The edge node must be the sub-ring node.
Switch_config_ring1# control-vlanvlan-id	It is an obligatory step. Sets the control VLAN and establishes VLAN “id” and VLAN “id-1”. <i>vlan-id</i> : ID of the control VLAN
Switch_config_ring1# pre-forward-timevalue	This step is optional. Configures the time of maintaining the pre-forwarding state of the edge port. <i>value</i> : It is a time value ranging from 3 to 30 seconds and the default value is 9 seconds.
Switch_config_ring1# exit	Saves the current settings and exits the node configuration mode.
Switch_config#	

27.2.3.4 Configuring a Single Sub-Ring Networking Mode

Configure a switch to be the master node of a ring network according to the following steps:

Command	Purpose
Switch# config	Enters the switch configuration mode.
Switch_config# mether-ring <i>id1</i> domain <i>id2</i>	Sets a node and enters the node configuration mode. <i>id1</i> : instance ID of a node <i>id2</i> : instance ID of a domain (omitted when it is 0)
Switch_config_ring1# edge-node [assistant-node]	It is an obligatory step. Sets the node type to be an edge node.
Switch_config_ring1# sub-ring	This step can be omitted. The edge node must be the sub-ring node.
Switch_config_ring1# control-vlan <i>vlan-id</i>	It is an obligatory step. Sets the control VLAN and establishes VLAN "id" and VLAN "id-1". <i>vlan-id</i> : ID of the control VLAN
Switch_config_ring2# single-subring-mode	It is an obligatory step. You can complete the ring configuration even if not using this command, but the system cannot enter the single-ring networking mode. In single sub-ring networking mode, the channel state of sub-ring protocol packet is not checked, and dual-affiliation networking must not exist in the ring. This command takes effect only on the edge node and the assistant node.
Switch_config_ring1# pre-forward-time <i>value</i>	This step is optional. Configures the time of maintaining the pre-forwarding state of the edge port. <i>value</i> : It is a time value ranging from 3 to 30 seconds and the default value is 9 seconds.
Switch_config_ring1# exit	Saves the current settings and exits the node configuration mode.
Switch_config#	

27.2.3.5 Configuring the Ring Port

Configure a port of a switch to be the port of Ethernet ring according to the following steps:

Command	Purpose
Switch# config	Enters the switch configuration mode.
Switch_config# interface <i>intf-name</i>	Enters the interface configuration mode.
Switch_config_intf# mether-ring <i>id1</i> domain <i>id2</i> primary-port [secondary-port]	Configures the type of the port of Ethernet ring. <i>id1</i> : instance ID of a node

transit-port common-port edge-port]	<i>id2</i> : instance ID of a domain (omitted when it is 0)
Switch_config_intf#exit	Exits from interface configuration mode.

Remarks:

The command, **no mether-ring *id1*domain *id2*primary-port [*secondary-port* | *transit-port* | *common-port* | *edge-port*]**, can be used to cancel the settings of the ring's port.

27.2.3.6 Browsing the State of the Ring Protection Protocol

Run the following command to browse the state of the ring protection protocol:

Command	Purpose
show mether-ring	Browoses the summary information about the ring protection protocol and the ports of ring.
show mether-ring <i>id1</i> domain <i>id2</i>	Browoses the summary information about the designated ring protection protocol and the ports of ring. <i>id1</i> : instance ID of a node <i>id2</i> : instance ID of a domain (omitted when it is 0)
show mether-ring <i>id1</i> domain <i>id2</i> detail	Browoses the detailed information about the designated ring protection protocol and the port of Ethernet ring.
show mether-ring <i>id1</i> domain <i>id2</i> interface <i>intf-name</i>	Browoses the states of the designated ring ports or those of the designated common ports.

27.3 Appendix

27.3.1 Working Procedure of MEAPS

MEAPS adopts three protection mechanisms to support the single-ring or evel-2 multi-ring structure. The following sections shows, from the complete state to the link-down state, then to recovery and finally to the complete state again, the details of MEAPS running and the change of the MEAPS topology by typical examples.

27.3.2 Complete state

The complete state of the ring, which is advocated for only one ring, is monitored and maintained by the polling mechanism. In complete status, all links on the whole ring are in UP state, which finds expression in the state of the master node. In order to prevent the broadcast storm from occurring, the master node will

block its secondary port. At the same time, the master node will periodically transmit the Hello packets from its primary port. These hello packets will pass through the transit node in sequence and finally return to the master node from its secondary port. The ring in complete state is shown in the following figure. The major ring and two sub rings are all in complete state. The hello packet of the major ring is only broadcast in the major ring, while the hello packet of the sub ring can be transparently transmitted through the major ring, then return to the sub ring, and finally get the secondary port of the master node on the sub ring.

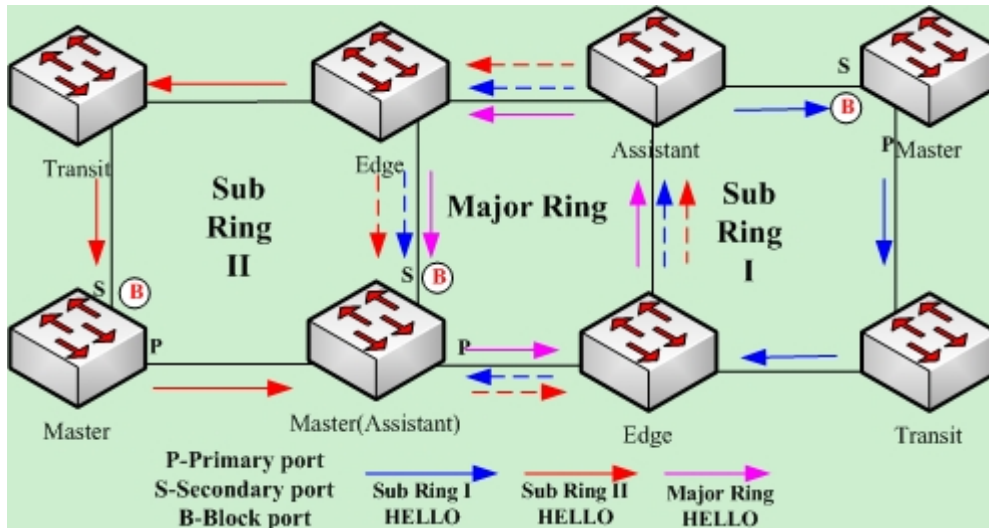

Figure 11: Complete state

27.3.2.1 Link-Down

The link-down state of the ring is decided by the polling mechanism, the notification of the link state change and the channel status checkup mechanism of the sub-ring protocol packet. Surely the link-down state of the ring is also advocated as to only one ring. When some link in the ring is in link-down state, the ring changes from the complete state to the troubled state, that is, the link-down state.

If link-down occurs on a link, the polling mechanism and the link status change notification mechanism will both function. The transit node, on which link-down occurs, will transmit the link-down packet to the master node through the Up port at its other side; at the same time, the polling mechanism will monitor and change promptly the state of the ring through Fail Time. When a trouble occurs on the sub-ring protocol channel, the trouble will be handled by the channel status checkup mechanism of the sub-ring protocol packet on the major ring. As shown in the following figure, the trouble notification message on the link of the major ring and on the common link is only transmitted on the major ring and finally transmitted to the master node; the trouble notification message on the link of sub ring 2 will be transmitted to the master node of the sub ring, which can be transparently transmitted through the major ring.

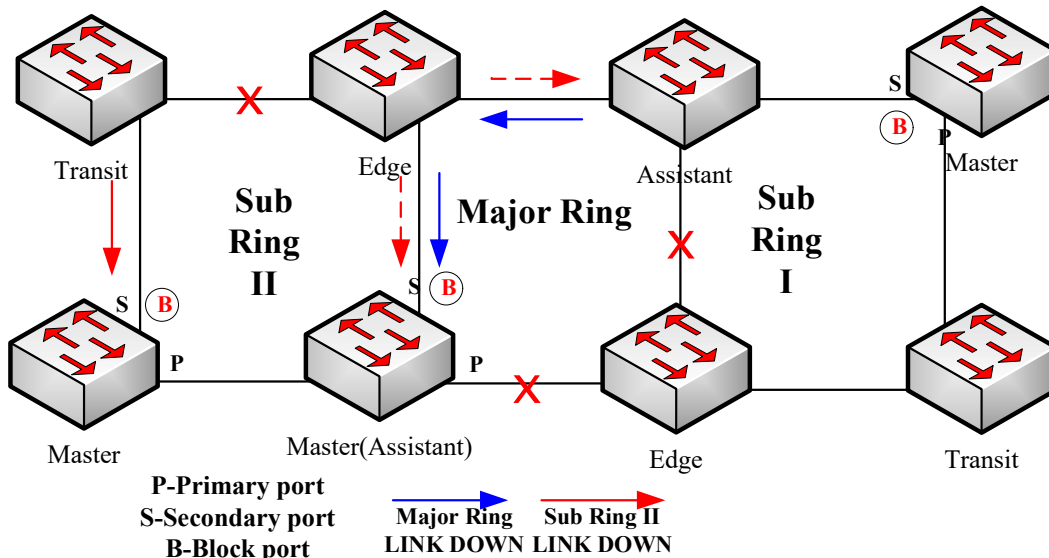

Figure 12: Ring transmitting the trouble and notifying the master node

After the master node receives the link-down packet, its state will be changed to the Failed state and at the same time the secondary port will be opened, the FDB table will be refreshed, and the RING-DOWN-FLUSH-FDB packets will be transmitted from two ports for notifying all nodes. As shown in the following figure, the master node on the major ring notifies the transit node on the major ring of refreshing FDB; sub ring 1 has troubles on its channel, so the edge port of the assistant node will be blocked; the master node of sub ring 2 notifies the transit nodes on the sub ring to refresh FDB and then the transparent transmission will be conducted on the major ring.

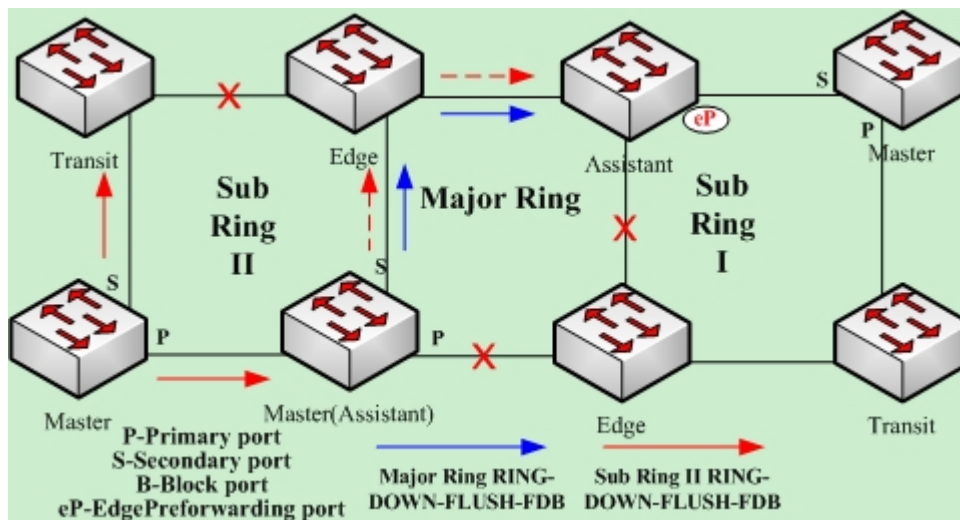

Figure 13: Ring transmitting troubles and refreshing FDB

27.3.2.2 Recovery

When the port on the transit node is recovered, the transit node will shift to its Preforwarding state. The processing procedure when the port of the transit node is recovered is shown in the following figure. The link of the major ring will recover, while the transit node, which connects the link of the major ring, changes into the Preforwarding state, blocks the data packets but allows the Hello packets of the control packet to pass

through; similarly, the transit node on sub ring 2 also changes into the Preforwarding state; when the hello packet on sub ring 1 arrives the edge node, due to the fact that the resumed transit node only allows the control packet of the major to pass through and that the hell packet of sub ring 1 is just like the data packet of the major ring, the hello packet cannot be forwarded.

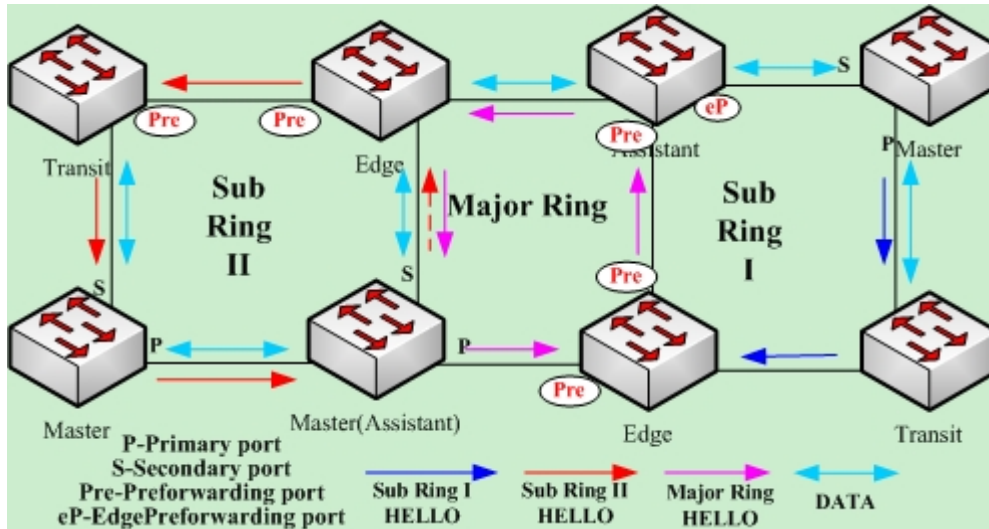

Figure 14: Recovery of the ring's link and the shift of the transit node to preforwarding

The transit port can transmit the control packet in preforwarding state, so the secondary port of the master node can receive the hello packet from the primary port. Hence, the master node shifts its state to Complete, blocks the secondary port and transmits the RING-UP-FLUSH-FDB packet from the primary port. After the transit node receives the RING-UP-FLUSH-FDB packet, the transit node will shift back to the Link-Up state, open the blocked port and refresh the FDB table. The procedure of ring recovery is shown in the following figure. The master node on the major ring changes into the complete state, blocks the secondary port, transmits the RING-UP-FLUSH-FDB packet to all transit nodes on the major ring and makes these transit nodes to shift back to their link-up state, to open the blocked port and to refresh the FDB table; similarly, the transit node and the master node on sub ring 2 also take on the corresponding change; due to the sub-ring protocol packet's channel recovery on sub ring 1, the secondary port of the master node can receive the hello packet from the primary port, and the master node shifts its state back to the complete state, blocks the secondary port, transmits the RING-UP-FLUSH-FDB packet and makes the assistant node open the edge port and sub ring 1 resume to its complete state.

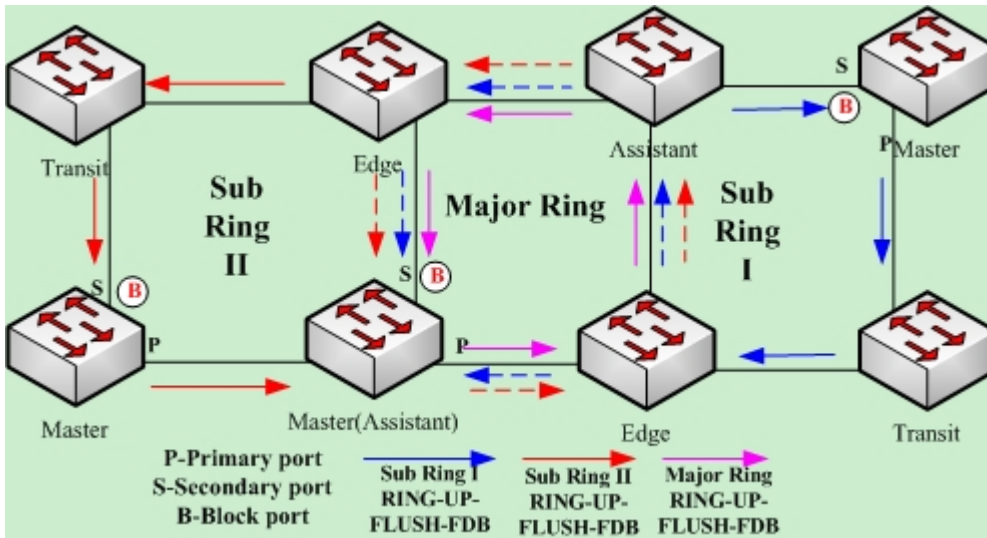
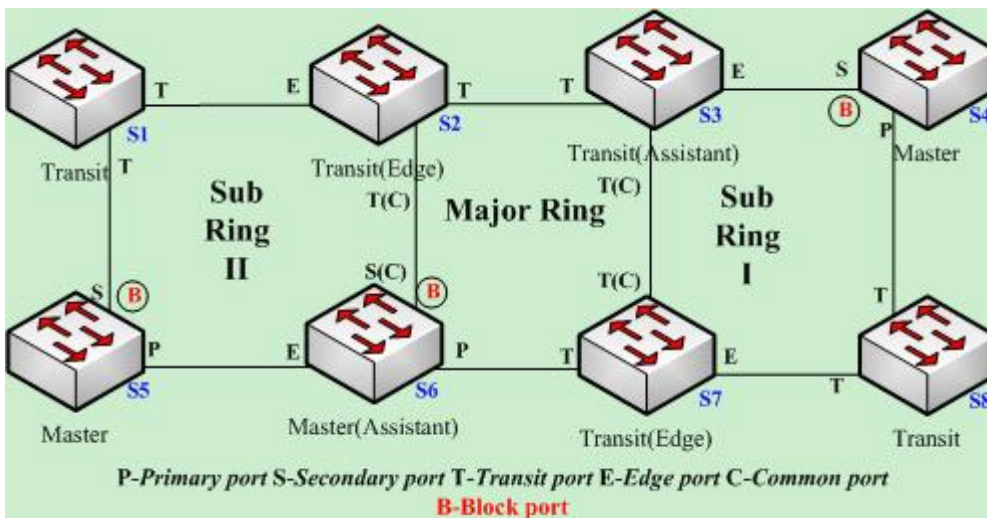

Figure 15: Ring recovery

Of course, if the transit node in Preforwarding state does not receive the RING-UP-FLUSH-FDB packet and Fail Time also exceeds, the transit node will open the blocked transit port and resume data communication.

27.3.3 MEAPS configuration

27.3.3.1 Configuration Example



MEAPS configuration

As shown in figure 2.1, master node S1 and transit node S2 are configured as follows. As to the settings of other nodes, they are the same as S2's settings.

Configuring switch S1:

The following commands are used to set the sub-ring transit node, node 2:

```
Switch_config#mether-ring 2 domain 1
```

```
Switch_config_ring2#transit-node
```

```
Switch_config_ring2#sub-ring
```

```
Switch_config_ring2#control-vlan 2
```

The following commands are used to set the time related parameters:

```
Switch_config_ring2#pre-forward-time 12
```

Exits from the node configuration mode:

```
Switch_config_ring2#quit
```

The following commands are used to set the transit port of node 2:

```
Switch_config#interface gigaEthernet 0/1
```

```
Switch_config_g0/1#mether-ring 2 domain 1 transit-port
```

```
Switch_config_g0/1#switchport mode trunk
```

```
Switch_config_g0/1#quit
```

```
Switch_config#interface gigaEthernet 0/2
```

```
Switch_config_g0/2#mether-ring 2 domain 1 transit-port
```

```
Switch_config_g0/2#switchport mode trunk
```

```
Switch_config_g0/2#quit
```

Configuring switch S2:

The following commands are used to set the major-ring transit node, node 1:

```
Switch_config#mether-ring 1 domain 1
```

```
Switch_config_ring1#transit-node
```

```
Switch_config_ring1#major-ring
```

```
Switch_config_ring1#control-vlan 2
```

The following commands are used to set the time related parameters:

```
Switch_config_ring1#pre-forward-time 12
```

Exits from the node configuration mode:

```
Switch_config_ring1#quit
```

The following commands are used to set the transit port of node 1:

```
Switch_config#interface gigaEthernet 0/1
```

```
Switch_config_g0/1#mether-ring 1 domain 1 transit-port
```

```
Switch_config_g0/1#switchport mode trunk
```

```
Switch_config_g0/1#quit
```

```
Switch_config#interface gigaEthernet 0/2
```

```
Switch_config_g0/2#mether-ring 1 domain 1 transit-port
```

```
Switch_config_g0/2#switchport mode trunk
```

```
Switch_config_g0/2#quit
```

The following commands are used to set the sub-ring edge node, node 2:

```
Switch_config#mether-ring 2 domain 1
```

```
Switch_config_ring2#edge-node
```

```
Switch_config_ring2#sub-ring (this can be omitted)
```

```
Switch_config_ring2#control-vlan 2
```

The following commands are used to set the time related parameters:

```
Switch_config_ring2#pre-forward-time 12
```

Exits from the node configuration mode:

```
Switch_config_ring2#quit
```

The following commands are used to set the common port and edge port of node 2:

```
Switch_config#interface gigaEthernet 0/2
```

```
Switch_config_g0/2#mether-ring 2 domain 1 common-port
```

```
Switch_config_g0/2#quit
```

```
Switch_config#interface gigaEthernet 0/3
```

```
Switch_config_g0/3#mether-ring 2 domain 1 edge-port
```

```
Switch_config_g0/3#switchport mode trunk
```

```
Switch_config_g0/3#quit
```

Configuring switch S3:

The following commands are used to set the major-ring transit node, node 1:

```
Switch_config#mether-ring 1 domain 1
```

```
Switch_config_ring1#transit-node
```

```
Switch_config_ring1#major-ring
```

```
Switch_config_ring1#control-vlan 2
```

The following commands are used to set the time related parameters:

```
Switch_config_ring1#pre-forward-time 12
```

Exits from the node configuration mode:

```
Switch_config_ring1#quit
```

The following commands are used to set the transit port of node 1:

```
Switch_config#interface gigaEthernet 0/1
```

```
Switch_config_g0/1#mether-ring 1 domain 1 transit-port
```

```
Switch_config_g0/1#switchport mode trunk
```

```
Switch_config_g0/1#quit
```

```
Switch_config#interface gigaEthernet 0/2
```

```
Switch_config_g0/2#mether-ring 1 domain 1 transit-port
```

```
Switch_config_g0/2#switchport mode trunk
```

```
Switch_config_g0/2#quit
```

The following commands are used to set the sub-ring assistant node, node 4:

```
Switch_config#mether-ring 4 domain 1
```

```
Switch_config_ring4#assistant-node
```

```
Switch_config_ring4#sub-ring (it can be omitted)
```

```
Switch_config_ring4#control-vlan 2
```

The following commands are used to set the time related parameters:

```
Switch_config_ring4#pre-forward-time 12
```

Exits from the node configuration mode:

```
Switch_config_ring4#quit
```

The following commands are used to set the common port and edge port of node 2:

```
Switch_config#interface gigaEthernet 0/2
```

```
Switch_config_g0/2#mether-ring 4 domain 1 common-port
```

```
Switch_config_g0/2#quit
```

```
Switch_config#interface gigaEthernet 0/3
```

```
Switch_config_g0/3#mether-ring 4 domain 1 edge-port
```

```
Switch_config_g0/3#switchport mode trunk
```

```
Switch_config_g0/3#quit
```

Configuring switch S4:

The following commands are used to set the sub-ring master node, node 4:

```
Switch_config#mether-ring 4 domain 1
```

```
Switch_config_ring4#master-node
```

```
Switch_config_ring4#sub-ring
```

```
Switch_config_ring4#control-vlan 2
```

The following commands are used to set the time related parameters:

```
Switch_config_ring4#hello-time 4
```

```
Switch_config_ring4#fail-time 12
```

Exits from the node configuration mode:

```
Switch_config_ring4#quit
```

The following commands are used to set the primary port and secondary port of node 4:

```
Switch_config#interface gigaEthernet 0/1
```

```
Switch_config_g0/1#mether-ring 4 domain 1 primary-port
```

```
Switch_config_g0/1#switchport mode trunk
```

```
Switch_config_g0/1#quit
```

```
Switch_config#interface gigaEthernet 0/2
```

```
Switch_config_g0/2#mether-ring 4 domain 1 secondary-port
```

```
Switch_config_g0/2#switchport mode trunk
```

```
Switch_config_g0/2#quit
```

Configuring switch S5:

The following commands are used to set the sub-ring master node, node 2:

```
Switch_config#mether-ring 2 domain 1
```

```
Switch_config_ring2#master-node
```

```
Switch_config_ring2#sub-ring
```

```
Switch_config_ring2#control-vlan 2
```

The following commands are used to set the time related parameters:

```
Switch_config_ring2#hello-time 4
```

```
Switch_config_ring2#fail-time 12
```

Exits from the node configuration mode:

```
Switch_config_ring2#quit
```

The following commands are used to set the primary port and secondary port of node 2:

```
Switch_config#interface gigaEthernet 0/1
```

```
Switch_config_g0/1#mether-ring 2 domain 1 primary-port
```

```
Switch_config_g0/1#switchport mode trunk
```

```
Switch_config_g0/1#quit
```

```
Switch_config#interface gigaEthernet 0/2
```

```
Switch_config_g0/2#mether-ring 2 domain 1 secondary-port
```

```
Switch_config_g0/2#switchport mode trunk
```

```
Switch_config_g0/2#quit
```

Configuring switch S6:

The following commands are used to set the major-ring master node, node 1:

```
Switch_config#mether-ring 1 domain 1
```

```
Switch_config_ring1#master-node
```

```
Switch_config_ring1#major-ring
```

```
Switch_config_ring1#control-vlan 2
```

The following commands are used to set the time related parameters:

```
Switch_config_ring1#hello-time 4
```

```
Switch_config_ring1#fail-time 12
```

Exits from the node configuration mode:

```
Switch_config_ring1#quit
```

The following commands are used to set the transit port of node 1:

```
Switch_config#interface gigaEthernet 0/1
```

```
Switch_config_g0/1#mether-ring 1 domain 1 primary-port
```

```
Switch_config_g0/1#switchport mode trunk
```

```
Switch_config_g0/1#quit
```

```
Switch_config#interface gigaEthernet 0/2
```

```
Switch_config_g0/2#mether-ring 1 domain 1 secondary-port
```

```
Switch_config_g0/2#switchport mode trunk
```

```
Switch_config_g0/2#quit
```

The following commands are used to set the sub-ring assistant node, node 2:

```
Switch_config#mether-ring 2 domain 1
```

```
Switch_config_ring2#assistant-node
```

```
Switch_config_ring2#sub-ring (This can be omitted)
```

```
Switch_config_ring2#control-vlan 2
```

The following commands are used to set the time related parameters:

```
Switch_config_ring2#pre-forward-time 12
```

Exits from the node configuration mode:

```
Switch_config_ring2#quit
```

The following commands are used to set the common port and edge port of node 2:

```
Switch_config#interface gigaEthernet 0/2
```

```
Switch_config_g0/2#mether-ring 2 domain 1 common-port
```

```
Switch_config_g0/2#quit
```

```
Switch_config#interface gigaEthernet 0/3
```

```
Switch_config_g0/3#mether-ring 2 domain 1 edge-port
```

```
Switch_config_g0/3#switchport mode trunk
```

```
Switch_config_g0/3#quit
```

Configuring switch S7:

The following commands are used to set the major-ring transit node, node 1:

```
Switch_config#mether-ring 1 domain 1
```

```
Switch_config_ring1#transit-node
```

```
Switch_config_ring1#major-ring
```

```
Switch_config_ring1#control-vlan 2
```

The following commands are used to set the time related parameters:

```
Switch_config_ring1#pre-forward-time 12
```

Exits from the node configuration mode:

```
Switch_config_ring1#quit
```

The following commands are used to set the transit port of node 1:

```
Switch_config#interface gigaEthernet 0/1
```

```
Switch_config_g0/1#mether-ring 1 domain 1 transit-port
```

```
Switch_config_g0/1#switchport mode trunk
```

```
Switch_config_g0/1#quit
```

```
Switch_config#interface gigaEthernet 0/2
```

```
Switch_config_g0/2#mether-ring 1 domain 1 transit-port
```

```
Switch_config_g0/2#switchport mode trunk
```

```
Switch_config_g0/2#quit
```

The following commands are used to set the sub-ring edge node, node 4:

```
Switch_config#mether-ring 4 domain 1
```

```
Switch_config_ring4#edge-node
```

```
Switch_config_ring4#sub-ring (This can be omitted)
```

```
Switch_config_ring4#control-vlan 2
```

The following commands are used to set the time related parameters:

```
Switch_config_ring4#pre-forward-time 12
```

Exits from the node configuration mode:

```
Switch_config_ring4#quit
```

The following commands are used to set the common port and edge port of node 4:

```
Switch_config#interface gigaEthernet 0/2
```

```
Switch_config_g0/2#mether-ring 4 domain 1 common-port
```

```
Switch_config_g0/2#quit
```

```
Switch_config#interface gigaEthernet 0/3
```

```
Switch_config_g0/3#mether-ring 4 domain 1 edge-port
```

```
Switch_config_g0/3#switchport mode trunk
```

```
Switch_config_g0/3#quit
```

Configuring switch S8:

The following commands are used to set the sub-ring transit node, node 4:

```
Switch_config#mether-ring 4 domain 1
```

```
Switch_config_ring4# transit -node
```

```
Switch_config_ring4#sub-ring
```

```
Switch_config_ring4#control-vlan 2
```

The following commands are used to set the time related parameters:

```
Switch_config_ring4#pre-forward-time 12
```

Exits from the node configuration mode:

```
Switch_config_ring4#quit
```

The following commands are used to set the transit port of node 4:

```
Switch_config#interface gigaEthernet 0/1
```

```
Switch_config_g0/1#mether-ring 4 domain 1 transit -port
```

```
Switch_config_g0/1#switchport mode trunk
```

```
Switch_config_g0/1#quit
```

```
Switch_config#interface gigaEthernet 0/2
```

```
Switch_config_g0/2#mether-ring 4 domain 1 transit -port
```

```
Switch_config_g0/2#switchport mode trunk
```

```
Switch_config_g0/2#quit
```

27.3.4 Unfinished Configurations (to be continued)

- Unfinished basic information configuration: there is one of the ring's role, the ring's grade and the control VLAN unset. One exceptional case is that when a node's role has configured to be the edge node or assistant node, the default ring's grade is sub-ring.
- Contradiction of basic information: When a node's role is edge-node or assistant-node, the default ring's grade is sub-ring; when the ring's grade is major-ring, prompt information will appear.
- Sub ring having no corresponding major-ring node: When a node's role is edge-node or assistant-node, this node is borne on the major-ring node; if there is no corresponding major-ring node to compulsorily

create the sub-ring edge node or sub-ring assistant node, prompt information will appear (in this case, you can use the **show** command to browse the MEAPS state; if you find the basic information is complete but the state is **init**, it indicates that the configuration of the ring's node has not finished).

- Conflicts arising during control VLAN configuration: If the control VLAN, which is configured by a node, conflicts with other configured nodes, prompt information will appear (in this case, you can use the **show** command to browse the MEAPS state; if you find the basic information is complete but the state is **init**, it indicates that the configuration of the ring's node has not finished).
- If a sub-ring node corresponding to a major-ring node is configured, the ID of the sub-ring node must be bigger than that of the major-ring node; if the sub-ring node's ID is less than the major-ring node's ID, the sub-ring node cannot be created and related prompt information pops out.

Chapter 28. ELPS Configuration

28.1 ELPS Overview

28.1.1 Overview

If DHCP snooping is enabled in a VLAN, the DHCP packets which are received from all distrusted physical ports in a VLAN will be legally checked. The DHCP response packets which are received from distrusted physical ports in a VLAN will then be dropped, preventing the faked or mis-configured DHCP server from providing address distribution services. For the DHCP request packet from distrusted ports, if the hardware address field in the DHCP request packet does not match the MAC address of this packet, the DHCP request packet is then thought as a fake packet which is used as the attack packet for DHCP DOS and then the switch will drop it.

Run the following commands in global configuration mode.

Command	Purpose
ip dhcp-relay snoopingvlan <i>vlan_id</i>	Enables DHCP-snooping in a VLAN.
no ip dhcp-snooping vlan <i>vlan_id</i>	Disables DHCP-snooping in a VLAN.

Setting an Interface to a DHCP-Trusting Interface

If an interface is set to be a DHCP-trusting interface, the DHCP packets received from this interface will not be checked.

Run the following commands in physical interface configuration mode.

Command	Purpose
dhcp snooping trust	Sets an interface to a DHCP-trusting interface.
no dhcp snooping trust	Resumes an interface to a DHCP-distrusted interface.

The interface is a distrusted interface by default.

Enabling DAI in a VLAN

When dynamic ARP monitoring is conducted in all physical ports of a VLAN, a received ARP packet will be rejected if the source MAC address and the source IP address of this packet do not match up with the configured MAC-IP binding relationship. The binding relationship on an interface can be dynamically bound by DHCP or configured manually. If no MAC addresses are bound to IP addresses on a physical interface, the switch rejects forwarding all ARP packets.

Command	Purpose
ip arp inspection vlan <i>vlanid</i>	Enables dynamic ARP monitoring on all

	distrusted ports in a VLAN.
no ip arp inspection vlan <i>vlanid</i>	Disables dynamic ARP monitoring on all distrusted ports in a VLAN.

Setting an Interface to an ARP-Trusting Interface

ARP monitoring is not enabled on those trusted interfaces. The interfaces are distrusted ones by default.

Run the following commands in interface configuration mode.

Command	Purpose
arp inspection trust	Sets an interface to an ARP-trusting interface.
no arp inspection trust	Resumes an interface to an ARP-distrusting interface.

Enabling Source IP Address Monitoring in a VLAN

After source IP address monitoring is enabled in a VLAN, IP packets received from all physical ports in the VLAN will be rejected if their source MAC addresses and source IP addresses do not match up with the configured MAC-to-IP binding relationship. The binding relationship on an interface can be dynamically bound by DHCP or configured manually. If no MAC addresses are bound to IP addresses on a physical interface, the switch rejects forwarding all IP packets received from the physical interface.

Run the following commands in global configuration mode.

Command	Purpose
ip verify source vlan <i>vlanid</i>	Enables source IP address checkup on all distrusted interfaces in a VLAN.
no ip verify source vlan <i>vlanid</i>	Disables source IP address checkup on all interfaces in a VLAN.



If the DHCP packet (also the IP packet) is received, it will be forwarded because global snooping is configured.

Setting an Interface to the One Which is Trusted by IP Source Address Monitoring

Source address checkup is not enabled on an interface if the interface has a trusted source IP address.

Run the following commands in interface configuration mode.

Command	Purpose
ip-source trust	Sets an interface to the one with a trusted source IP address.

no ip-source trust	Resumes an interface to the one with a distrusted source IP address.
--------------------	--

Configuring the TFTP Server for Backing up Interface Binding

After the switch configuration is rebooted, the previously-configured interface binding will be lost. In this case, there is no binding relationship on this interface. After source IP address monitoring is enabled, the switch rejected forwarding all IP packets. After the TFTP server is configured for interface binding backup, the binding relationship will be backed up to the server through the TFTP protocol. After the switch is restarted, the switch automatically downloads the binding list from the TFTP server, securing the normal running of the network.

Run the following commands in global configuration mode.

Command	Purpose
ip dhcp-relay snooping database-agent <i>ip-address</i>	Configures the IP address of the TFTP server which is to back up interface binding.
no ip dhcp-relay snooping database-agent	Cancels the TFTP Server for backing up interface binding.

Configuring a File Name for Interface Binding Backup

When backing up the interface binding relationship, the corresponding file name will be saved on the TFTP server. In this way, different switches can back up their own interface binding relationships to the same TFTP server.

Run the following commands in global configuration mode.

Command	Purpose
ip dhcp-relay snooping db-file <i>name</i>	Configures a file name for interface binding backup.
no ip dhcp-relay snooping db-file	Cancels a file name for interface binding backup.

Configuring the Interval for Checking Interface Binding Backup

The MAC-to-IP binding relationship on an interface changes dynamically. Hence, you need check whether the binding relationship updates after a certain interval. If the binding relationship updates, it need be backed up again. The default interval is 30 minutes.

Run the following commands in global configuration mode.

Command	Purpose
ip dhcp-relay snooping write <i>num</i>	Configures the interval for checking interface binding backup.

no ip dhcp-relay snooping write	Resumes the interval of checking interface binding backup to the default settings.
---------------------------------	--

Configuring Interface Binding Manually

If a host does not obtain the address through DHCP, you can add the binding item on an interface of a switch to enable the host to access the network. You can run **no ip source binding MAC IP** to delete items from the corresponding binding list.

Note that the manually-configured binding items have higher priority than the dynamically-configured binding items. If the manually-configured binding item and the dynamically-configured binding item have the same MAC address, the manually-configured one updates the dynamically-configured one. The interface binding item takes the MAC address as the unique index.

Run the following commands in global configuration mode.

Command	Purpose
ip source binding <i>MAC IP interface name</i>	Configures interface binding manually.
no ip source binding <i>MAC IP</i>	Cancels an interface binding item.

L2 Switch Forwarding DHCP Packets

The following command can be used to forward the DHCP packets to the designated DHCP server to realize DHCP relay. The negative form of this command can be used to shut down DHCP relay.



This command can only be used to enable DHCP relay on L2 switches, while on L3 switches, DHCP relay is realized by the DHCP server.

Run the following commands in global configuration mode.

Command	Purpose
ip dhcp-relay agent	Enables DHCP relay.
ip dhcp-relay helper-address <i>addressvlanvlan-id</i>	Configures the destination address and VLAN of the relay.

Monitoring and Maintaining DHCP-Snooping

Run the following commands in EXEC mode:

Command	Purpose
show ip dhcp-relay snooping	Displays the information about DHCP-snooping configuration.
show ip dhcp-relay snooping binding	Displays the effective address binding items on an interface.

show ip dhcp-relay snooping binding all	Displays all binding items which are generated by DHCP snooping.
[no] debug ip dhcp-relay [snooping binding event]	Enables or disables the switch of DHCP relay snooping.

The following shows the information about the DHCP snooping configuration:

```
switch#show ip dhcp-relay snooping
ip dhcp-relay snooping vlan 3
ip arp inspection vlan 3
DHCP Snooping trust interface:
FastEthernet0/1
ARP Inspect interface:
FastEthernet0/11
```

The following shows the binding information about dhcp-relay snooping:

```
switch#show ip dhcp-relay snooping binding
Hardware Address  IP Address  remainder time Type      VLAN  interface
a8-f7-e0-26-23-89 192.2.2.101  86400    DHCP_SN    3    FastEthernet0/3
```

The following shows all binding information about dhcp-relay snooping:

```
switch#show ip dhcp-relay snooping binding all
Hardware Address  IP Address  remainder time Type      VLAN  interface
a8-f7-e0-32-1c-59 192.2.2.1   infinite  MANUAL    1    FastEthernet0/2
a8-f7-e0-26-23-89 192.2.2.101  86400    DHCP_SN    3    FastEthernet0/3
```

The following shows the information about dhcp-relay snooping.

```
switch#debug ip DHCP-snooping packet
DHCPR: receive l2 packet from vlan 3, diID: 3
DHCPR: DHCP packet len 277
DHCPR: add binding on interface FastEthernet0/3
DHCPR: send packet continue
DHCPR: receive l2 packet from vlan 3, diID: 1
DHCPR: DHCP packet len 300
```

```
DHCPR: send packet continue
DHCPR: receive I2 packet from vlan 3, diID: 3
DHCPR: DHCP packet len 289
DHCPR: send packet continue
DHCPR: receive I2 packet from vlan 3, diID: 1
DHCPR: DHCP packet len 300
DHCPR: update binding on interface FastEthernet0/3
DHCPR: IP address: 192.2.2.101, lease time 86400 seconds
DHCPR: send packet continue
```

Chapter 29. UDLD Configuration

29.1 Unidirectional Link Detection (UDLD)

29.1.1 UDLD Overview

UDLD is a L2 protocol that monitors the physical location of the cable through the devices which are connected by optical cable or twisted-pair, and detects whether the unidirectional link exists. Only when the connected device supports UDLD can the unidirectional link be detected and shut down. The unidirectional link can cause a lot of problems, including the STP topology ring. Hence, when detecting a unidirectional link, UDLD will shut down the affected interface and notify users.

UDLD works with the physical-layer protocol mechanism to judge the status of the physical link. On the physical layer, the physical signals and incorrect detections are automatically negotiated and processed, while UDLD processes other matters, such as detecting the ID of a neighbor and shutting down the incorrect connection port. If you enable automatic negotiation and UDLD, the detection at layer 1 and layer 2 can prevent physical/logical links and other protocols' problems.

29.1.1.1 UDLD Mode

UDLD supports two modes, the normal mode (default) and the aggressive mode. In normal mode, UDLD can detect the existence of a unidirectional link according to the unidirectional services of the link. In aggressive mode, UDLD can detect not only the existence of a unidirectional link as in the previous mode but also connection interruption which cannot be detected by L1 detection protocols.

In **normal** mode, if UDLD determines that the connection is gone, UDLD will set the state of the port to **undetermined**, not to **down**. In **aggressive** mode, if UDLD determines that the link is gone and the link cannot be reconnected, it is thought that interrupted communication is a severe network problem and UDLD will set the state of the protocol to **linkdown** and the port is in **errdisable** state. No matter in what mode, if UDLD maintains it is a bidirectional link, the port will be set to **bidirectional**.

In **aggressive** mode, UDLD can detect the following cases of the unidirectional link:

- On the optical fiber or the twisted pair, an interface cannot receive or transmit services.
- On the optical fiber or the twisted pair, the interface of one terminal is down and the interface of the other terminal is up.
- One line in the optical cable is broken, and therefore the data can only be transmitted or only be received.

In previous cases, UDLD will shut down the affected interface.

29.1.1.2 Running Mechanism

UDLD is a L2 protocol running on the LLC layer, which uses 01-00-0c-cc-cc-cc as its destination MAC address. SNAP HDLC is similar to 0x0111. When it runs with layer-1 FEF1 and automatic negotiation, the

completeness of a link in the physical layer and the logical link layer can be checked.

UDLD can provide some functions that FEF1 and automatic negotiation cannot conduct, such as checking and caching the neighbor information, shutting down any mis-configured port and checking the faults and invalidation on the logical ports except the point-to-point logical ports.

UDLD adopts two basic mechanisms: learn the information about neighbors and save it in the local cache.

When a new neighbor is detected or a neighbor applies for synchronizing the cache again, a series of UDLD probe/echo (hello) packets will be transmitted.

UDLD transmits the probe/echo packets on all ports and, when a UDLD echo information is received on the ports, a detection phase and an authentication process are triggered. If all effective conditions are satisfied (port is connected in two directions and the cable is correctly connected), this port will be up. Otherwise, the port will be down.

Once a link is established and labeled as bidirectional, UDLD will transmit a probe/echo message every 15 seconds.

29.1.1.3 State of the Port

The UDLD interface may be in one of the following states:

Port state	Remark
Detection	Means that the interface is in detection state.
Unknown	Means that the interface is in unknown state, that is, it may be in detection state or it has not conducted detection.
Unidirectional	Means that the unidirectional connection has been detected.
Bidirectional	Means that the bidirectional connection has been detected.

29.1.1.4 Maintaining the Cache of the Neighbor

UDLD transmits the Probe/Echo packets regularly on each active interface to maintain the completeness of the neighbor's cache. Once a Hello message is received, it will be saved in the memory temporarily and an interval that is defined by hold-time will also be saved. If the hold-time times out, the corresponding cache is fully cleared. If a new Hello message is received in the hold-time, the new Hello message will replace the old one and the timer will be reset to zero.

Once a UDLD-running interface is disabled or the device on the interface is restarted, all the caches on the interface will be removed to maintain the completeness of the UDLD cache. UDLD transmits at least one message to notify the neighbor to remove the corresponding cache items.

29.1.1.5 Echo Detection

The echo mechanism is the basis of the detection algorithm. Once a UDLD device learns a new neighbor or

another synchronization request from an asynchronous neighbor, it will start or restart the detection window of the local terminal and transmit an echo message for full agreement. Because all neighbors are demanded a corresponding action, the echo sender expects an **echos** message. If the checkup window is over before a legal echo is received, this link is thought to be a unidirectional one. In this case, link reconnection will be triggered or the **link down** process on the port is enabled.

29.1.2 UDLD Configuration Task List

- Globally Enabling or Disabling UDLD
- Enabling or Disabling the UDLD Interface
- Setting the Message Interval of the Aggressive Mode
- Restarting the Interface Shut Down by UDLD
- Displaying the UDLD State

29.1.3 UDLD Configuration Tasks

29.1.3.1 Globally Enabling or Disabling UDLD

In global configuration mode, run the following command to enable the UDLD function of all interfaces.

Command	Purpose
udld [enable aggressive]	Enables the UDLD modules of all interfaces in some mode.

In global configuration mode, run the following command to disable the UDLD function of all interfaces.

Command	Purpose
no udld [enable aggressive]	Shuts down the UDLD modules of all interfaces.



If you enable or disable the UDLD function in global configuration mode, the UDLD function will be performed on all interfaces.

UDLD of the Aggressive mode is a variation of UDLD, which can provide extra benefits. When UDLD is in aggressive mode and the port stops transmitting the UDLD packets, UDLD will try to establish a link with its neighbor again. If the times of tries exceed a certain number, the state of the port is changed into the Error-Disable state and the link of the port is down. When UDLD is running, the ports at both terminals should run in the same mode, or the expecting result cannot be obtained.

29.1.3.2 Enabling or Disabling the UDLD Interface

In interface configuration mode, run the following command to enable the UDLD function of an interface.

Command	Purpose

udld port [aggressive]	Enables the UDLD module of an interfaces in some mode. If the aggressive parameter is not entered, the UDLD function of the interface is enabled in normal mode; if the aggressive parameter is entered, the UDLD function of the interface is enabled in aggressive mode.
---	--

In interface configuration mode, run the following command to disable the UDLD function of an interface.

Command	Purpose
no udld port [aggressive]	Disables the UDLD module of the interface by entering the corresponding command in some mode.



When UDLD is running, the ports at both terminals should run in the same mode, or the expecting result cannot be obtained.

29.1.3.3 Setting the Message Interval of the Aggressive Mode

In global configuration mode, run the following command to set the message interval of the aggressive mode.

Command	Purpose
udld message <i>time</i>	Sets the message interval of the aggressive mode.

29.1.3.4 Restarting the Interface Shut Down by UDLD

In the EXEC mode, run the following command to restart the interface that is shut down by the UDLD module.

Command	Purpose
udld reset	Restarts the interface shut down by UDLD.

29.1.3.5 Displaying the UDLD State

Run the following command to display the states of the UDLD modules of all current interfaces.

Command	Purpose
show udld	Displays the states of the UDLD modules of all current interfaces.

Run the following command to display the state of the UDLD module of the specified interface.

Command	Purpose
show udld <i>interface</i>	Displays the state of the UDLD module of the specified interface.

The UDLD displaying command is used to browse the state and the mode of UDLD, the current detection state, the state of the current link and some information about the neighbors.

It is used to display the running states of the UDLD modules of the current interfaces.

```
Switch#show udld

Interface FastEthernet0/1
---
Port enable administrative configuration setting: Enabled
Port enable operational state: Enabled
Current bidirectional state: Bidirectional
Current operational state: Advertisement
Message interval: 15
Time out interval: 5
Entry 1
  ---
Expiration time: 42
Cache Device index: 1
Device ID: CAT0611Z0L9
Port ID: FastEthernet0/1
Neighbor echo 1 device: S35000202
Neighbor echo 1 port: FastEthernet0/1

Message interval: 15
Time out interval: 5
UDLD Device name: Switch

Interface FastEthernet0/2
---
Port enable administrative configuration setting: Disabled
Port enable operational state: Disabled
Current bidirectional state: Unknown

Interface FastEthernet0/3
---
Port enable administrative configuration setting: Disabled
Port enable operational state: Disabled
Current bidirectional state: Unknown
```



It is used to display the operational state of the UDLD module of the current interface.

```
Switch#show udld interface f0/1
Interface FastEthernet0/1
---
Port enable administrative configuration setting: Enabled
Port enable operational state: Enabled
Current bidirectional state: Bidirectional
Current operational state: Advertisement
Message interval: 15
Time out interval: 5
Entry 1
  ---
Expiration time: 42
Cache Device index: 1
Device ID: CAT0611Z0L9
Port ID: FastEthernet0/1
Neighbor echo 1 device: S35000202
Neighbor echo 1 port: FastEthernet0/1

Message interval: 15
Time out interval: 5
UDLD Device name: Switch
```

29.1.4 Configuration Example

29.1.4.1 Network Environment Requirements

Configure the UDLD protocol on the ports that connect two switches.

29.1.4.2 Network Topology

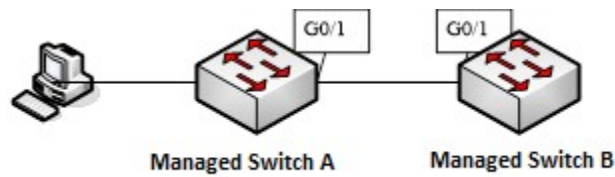

Figure 2 Network topology

29.1.4.3 Configuration Procedure

Configuring managed switch A:

```
Switch_config#udld enable
```

```
Switch_config#
```

Configuring managed switch B:

```
Switch_config#udld enable
```

```
Switch_config#
```

Entering the **show** command on managed switch A:

```
Switch_config#show udld interface g0/1
```

```
Interface g0/1
```

```
---
```

```
Port enable administrative configuration setting: Enabled
```

```
Port enable operational state: Enabled
```

```
Current bidirectional state: Unknown
```

```
Current operational state: Detection
```

```
Message interval: 15
```

```
Time out interval: 1
```

```
Entry 1
```

```
---
```

```
Expiration time: 44
```

```
Cache Device index: 1
```

```
Device ID: XGS-6350-24X4C
```

```
Port ID: FastEthernet0/1
```

```
Neighbor echo 1 device: XGS-6350-24X4C
```

```
Neighbor echo 1 port: FastEthernet0/1
```

```
Message interval: 15
```

```
Time out interval: 1
```

```
UDLD Device name: XGS-6350-24X4C
```

```
Switch_config#
```

```
Switch_config#show udd interface f0/1
```

```
Interface FastEthernet0/1
```

```
---
```

```
Port enable administrative configuration setting: Enabled
```

```
Port enable operational state: Enabled
```

```
Current bidirectional state: Unknown
```

```
Current operational state: Advertisement
```

```
Message interval: 15
```

```
Time out interval: 7
```

```
Entry 1
```

```
---
```

```
Expiration time: 43
```

```
Cache Device index: 1
```

```
Device ID: XGS-6350-24X4C
```

```
Port ID: FastEthernet0/1
```

```
Neighbor echo 1 device: XGS-6350-24X4C
```

```
Neighbor echo 1 port: FastEthernet0/1
```

```
Message interval: 15
```

```
Time out interval: 7
```

```
UDLD Device name: XGS-6350-24X4C
```

```
Switch_config#
```

```
Switch_config#show udd interface f0/1
```

```
Interface FastEthernet0/1
```

```
---
```

```
Port enable administrative configuration setting: Enabled
```

```
Port enable operational state: Enabled
```

```
Current bidirectional state: Bidirectional
```

```
Current operational state: Advertisement
```

```
Message interval: 15
```

```
Time out interval: 15
```

```
Entry 1
```

```
---
```

```
Expiration time: 36
```

```
Cache Device index: 1
```

```
Device ID: XGS-6350-24X4C
```

```
Port ID: FastEthernet0/1
```

```
Neighbor echo 1 device: XGS-6350-24X4C
```

Neighbor echo 1 port: FastEthernet0/1

Message interval: 15

Time out interval: 15

UDLD Device name: XGS-6350-24X4C

Switch_config#

From the information above, you can find the three phases of the link state which UDLD detects:

Detection phase: In this phase, the UDLD packets are transmitted every other second.

Unknown phase: In this phase, the UDLD packets are transmitted every eight seconds.

Known bidirectional/unidirectional connection phase: Once a link is established and labeled as bidirectional, UDLD will transmit a probe/echo message every 16 seconds.

Chapter 30. IGMP-Snooping Configuration

30.1 IGMP-snooping Configuration

30.1.1 IGMP-snooping Configuration Task

The task of IGMP-snooping is to maintain the relationships between VLAN and group address and to update simultaneously with the multicast changes, enabling layer-2 switches to forward data according to the topology structure of the multicast group.

The main functions of IGMP-snooping are shown as follows:

- Listening IGMP message;
- Maintaining the relationship table between VLAN and group address;
- Keeping the IGMP entity of host and the IGMP entity of router in the same state to prevent flooding from occurring.



Because igmp-snooping realizes the above functions by listening the **query** message and **report** message of igmp, igmp-snooping can function properly only when it works on the multicast router, that is, the switch must periodically receive the igmp **query** information from the router. The **router age** timer of igmp-snooping must be set to a time value that is bigger than the group query period of the multicast router connecting igmp-snooping. You can check the multicast router information in each VLAN by running **show ip igmp-snooping**.

- Enabling/Disabling IGMP-snooping of VLAN
- Adding/Deleting static multicast address of VLAN
- Configuring immediate-leave of VLAN
- Configuring the function to filter multicast message without registered destination address
- Configuring the Router Age timer of IGMP-snooping
- Configuring the Response Time timer of IGMP-snooping
- Configuring IGMP Querier of IGMP-snooping
- Monitoring and maintaining IGMP-snooping
- IGMP-snooping configuration example

30.1.1.1 Enabling/Disabling IGMP-Snooping of VLAN

Perform the following configuration in global configuration mode:

Command	Description
ip igmp-snooping [vlanvlan_id]	Enables IGMP-snooping of VLAN.
no ip igmp-snooping [vlanvlan_id]	Resumes the default configuration.

If vlan is not specified, all vlans in the system, including vlans created later, can be enabled or disabled.

In the default configuration, IGMP-snooping of all VLANs is enabled, just as the **ip igmp-snooping** command is configured.



IGMP-snooping can run on up to 16 VLANs.

To enable IGMP-snooping on VLAN3, you must first run **no ip IGMP-snooping** to disable IGMP-snooping of all VLANs, then configure **ipIGMP-snooping VLAN 3** and save configuration.

30.1.1.2 Adding/Deleting Static Multicast Address of VLAN

Hosts that do not support IGMP can receive corresponding multicast message by configuring the static multicast address.

Perform the following configuration in global configuration mode:

Command	Description
<code>ip igmp-snoopingvlanvlan_id staticA.B.C.D interfaceintf</code>	Adds static multicast address of VLAN.
<code>no ip igmp-snooping vlanvlan_id staticA.B.C.D interfaceintf</code>	Deletes static multicast address of VLAN.

30.1.1.3 Configuring immediate-leave of VLAN

When the characteristic immediate-leave is configured, the switch can delete the port from the port list of the multicast group after the switch receives the **leave** message. The switch, therefore, does not need to enable the timer to wait for other hosts to join the multicast. If other hosts in the same port belongs to the same group and their users do not want to leave the group, the multicast communication of these users may be affected. In this case, the **immediate-leave** function should not be enabled.

Perform the following configuration in global configuration mode:

Command	Description
<code>ip igmp-snooping vlan vlan_id immediate-leave</code>	Configures the immediate-leave function of the VLAN.
<code>no ip igmp-snooping vlanvlan_idimmediate-leave</code>	Sets immediate-leave of VLAN to its default value.

The **immediate-leave** characteristic of VLAN is disabled by default.

30.1.1.4 Configuring the Function to Filter Multicast Message Without Registered Destination Addresses

When multicast message target fails to be found (DHL, the destination address is not registered in the switch

chip through igmp-snooping), the default process method is to send message on all ports of VLAN. Through configuration, you can change the process method and all multicast messages whose destination addresses are not registered to any port will be dropped.

Command	Description
ip igmp-snooping dlf-frames <i>filter</i>	Drops multicast message whose destination fails to be found.
no ip igmp-snooping dlf-frames	Resumes the fault configuration (forward).



- (1) The attribute is configured for all VLANs.
- (2) The default method for the switch to handle this type of message is forward (message of this type will be broadcasted within VLAN).

30.1.1.5 Configuring Router Age Timer of IGMP-snooping

The **Router Age** timer is used to monitor whether the IGMP inquirer exists. IGMP inquirers maintains multicast addresses by sending **query** message. IGMP-snooping works through communication between IGMP inquirer and host.

Perform the following configuration in global configuration mode:

Command	Description
ip igmp-snooping timer router-age <i>timer_value</i>	Configures the value of Router Age of IGMP-snooping.
no ip igmp-snooping timer router-age	Resumes the default value of Router Age of IGMP-snooping.



For how to configure the timer, refer to the query period setup of IGMP inquirer. The timer cannot be set to be smaller than query period. It is recommended that the timer is set to three times of the query period.

The default value of Router Age of IGMP-snooping is 260 seconds.

30.1.1.6 Configuring Response Time Timer of IGMP-Snooping

The **response time** timer is the upper limit time that the host reports the multicast after IGMP inquirer sends the **query** message. If the **report** message is not received after the timer ages, the switch will delete the multicast address.

Perform the following configuration in global configuration mode:

Command	Description
ip igmp-snooping timer	Configures the value of Response Time

response-timer <i>timer_value</i>	of IGMP-snooping.
no ip igmp-snooping timer response-time	Resumes the default value of Response Time of IGMP-snooping.



The timer value cannot be too small. Otherwise, the multicast communication will be unstable.

The value of Response Time of IGMP-snooping is set to ten seconds.

30.1.1.7 Configuring Querier of IGMP-Snooping

If the multicast router does not exist in VLAN where IGMP-snooping is activated, the **querier** function of IGMP-snooping can be used to imitate the multicast router to regularly send IGMP **query** message. (The function is global, that is, it can be enabled or disabled in VLAN where IGMP-snooping is globally enabled) When the multicast router does not exist in LAN and multicast flow does not need routing, the automatic query function of the switch can be activated through IGMP snooping, enabling IGMP snooping to work properly. Perform the following configuration in global configuration mode:

Command	Description
[no] ip igmp-snooping querier [address/ <i>ip_addr</i>]	Configures the querier of IGMP-snooping. The optional parameter address is the source IP address of query message.

The **IGMP-snooping querier** function is disabled by default. The source IP address of fake **query** message is 10.0.0.200 by default.



If the querier function is enabled, the function is disabled when the multicast router exists in VLAN; the function can be automatically activated when the multicast router times out.

30.1.1.8 Monitoring and Maintaining IGMP-Snooping

Perform the following operations in management mode:

Command	Description
show ip igmp-snooping	Displays IGMP-snooping configuration information.
show ip igmp-snooping timer	Displays the clock information of IGMP-snooping.
show ip igmp-snooping groups	Displays information about the multicast group of IGMP-snooping.
show ip igmp-snooping statistics	Displays statistics information about

	IGMP-snooping.
[no] debug ip igmp-snooping [packet timer event error]	Enables and disables packet/clock debug/event/mistake print switch of IGMP-snooping. If the debug switch is not specified, all debug switches will be enabled or disabled.

Display VLAN information about IGMP-snooping running:

```
switch#show ip igmp-snooping
igmp-snooping response time: 10 s
vlan 1
-----
running
Router: 90.0.0.120(F0/2)
```

Display information about the multicast group of IGMP-snooping:

```
switch#show ip igmp-snooping groups
Vlan Source      Group          Type Port(s)
-----
1 0.0.0.0 234.5.6.6 IGMP F0/2
1 0.0.0.0 239.255.255.250 IGMP F0/2
```

Display IGMP-snooping timer:

```
switch#show ip igmp-snooping timers
vlan 1 router age : 251 Indicating the timeout time of the router age timer
vlan 1 multicast address 0100.5e00.0809 response time : 1 Indicating the period from when the last multicast group query message is received to the current time; if no host on the port respond when the timer times out, the port will be deleted..
```

Display IGMP-snooping statistics:

```
switch#show ip igmp-snooping statistics
vlan 1
-----
v1_packets: 0 IGMP v1 packet number
v2_packets: 6 IGMP v2 packet number
v3_packets: 0 IGMP v3 packet number
```

```
general_query_packets: 5  General query of the packet number
special_query_packets: 0  Special query of the packet number
join_packets: 6  Number of report packets
leave_packets: 0  Number of Leave packets
send_query_packets: 0  Rerved statistics option
err_packets: 0  Number of incorrect packets
```

Debug the message timer of IGMP-snooping:

```
switch#debug ip igmp-snooping packet
rx: s_ip: 90.0.0.3, d_ip: 224.0.8.9  Source and destination IP addresses where packets are received
    type: 16(V2-Report), max resp: 00, group address: 224.0.8.9  Type and content of packet
rx: s_ip: 90.0.0.90, d_ip: 224.0.0.1
    type: 11(Query), max resp: 64, group address: 0.0.0.0
rx: s_ip: 90.0.0.3, d_ip: 224.0.8.9
    type: 16(V2-Report), max resp: 00, group address: 224.0.8.9
rx: s_ip: 90.0.0.3, d_ip: 224.0.0.2
    type: 17(V2-Leave), max resp: 00, group address: 224.0.8.9
rx: s_ip: 90.0.0.90, d_ip: 224.0.8.9
    type: 11(Query), max resp: 0a, group address: 224.0.8.9
```

Debug the message timer of IGMP-snooping:

```
switch#debug ip igmp-snooping timer
tm: vlan 1 igmp router age expiry at port 2(F0/2)
tm: multicast item 0.0.0.0->224.0.8.9(0100.5e00.0809) response time expiry at port F0/4  Inquering the
response timer expiry
```

30.1.1.9 IGMP-Snooping Configuration Example

Figure 1 shows network connection of the example.

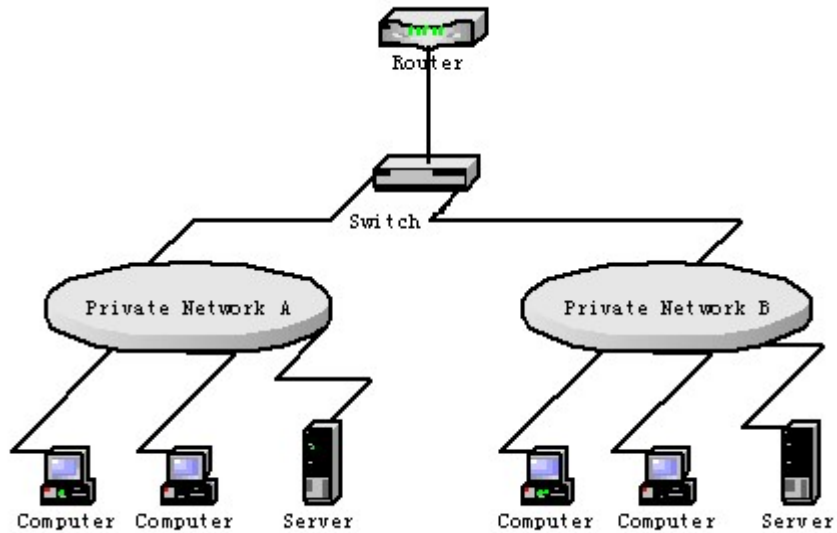

Configuring Switch

- (1) Enable IGMP-snooping of VLAN 1 connecting Private Network A.

```
Switch_config#ip igmp-snooping vlan 1
```

- (2) Enable IGMP-snooping of VLAN 2 connecting Private Network B.

```
Switch_config#ip igmp-snooping vlan 2
```

Chapter 31. IGMP-Proxy Configuration

31.1 IGMP-proxy Configuration

31.1.1.1 IGMP-proxy Configuration Tasks

The IGMP Proxy allows the VLAN where the multicast user is located to receive the multicast source from other VLANs. The IGMP Proxy runs on layer 2 independently without other multicast routing protocols. IGMP proxy will be transmitted by the IGMP packets of the proxied VLAN to the proxying VLAN and maintain the hardware forward table of the multicast user of the agent VLAN according to these IGMP packets. IGMP proxy divides different VLANs into two kinds: proxied VLANs and proxying VLANs. The downstream multicast VLANs can be set to the proxied VLANs, while the upstream multicast VLANs can be set to the proxying VLANs.

Although IGMP proxy is based on IGMP snooping, two are independent in application; IGMP Snooping will not be affected when IGMP proxy is enabled or disabled, while IGMP proxy can run only when IGMP Snooping is enabled.

IGMP proxy cannot be used unless the following conditions are met:

- (1) L3 switch
- (2) Avoiding to enable IP multicast routing at the same time
- (3) Preventing a vlan to act as downstream vlan and also upstream vlan

- Enabling/Disabling IGMP-Proxy
- Adding/deleting VLAN agent relationship
- Adding/deleting static multicast source entries
- Monitoring and Maintaining IGMP-Proxy
- Setting the Example of IGMP Proxy

31.1.1.2 Enabling/Disabling IGMP-Proxy

Run the following commands in global configuration mode.

Command	Purpose
ip igmp-proxyenable	Enables IGMP proxy.
no ip igmp-proxyenable	Resumes the default settings.



IGMP-proxy cannot be enabled after IP multicast-routing is enabled. The previously enabled IGMP proxy is automatically shut down if IP multicast routing is enabled. The shutdown of ip multicast-routing will not lead to the automatic enablement of IGMP proxy.

31.1.1.3 Adding/Deleting VLAN Agent Relationship

Run the following commands in global configuration mode.

Command	Purpose
ip igmp-proxyagent-vlan <i>avlan_map</i> client-vlan map <i>cvlan_map</i>	Adds the agent VLAN (<i>avlan_map</i>) to manage the represented vlan (<i>cvlan_map</i>).
no ip igmp-proxyagent-vlan <i>avlan_map</i> client-vlan map <i>cvlan_map</i>	Deletes the agent relationship.



- (1) The represented VLAN cannot be configured before *vlan* is designated by *avlan_map*; also, the agent VLAN cannot be configured before *cvlan_map*.
- (2) The represented and agent VLANs must accept the control of IGMP-Snooping.

31.1.1.4 Adding/Deleting Static Multicast Source Entries

Run the following commands in global configuration mode.

Command	Purpose
ip igmp-proxy source <i>multi_ipsrc_ip svlan</i> <i>vlan_id sport</i> <i>intf_name</i>	Adds entries of the static source multicast.
no ip igmp-proxy source <i>multi_ipsrc_ip</i> svlan <i>vlan_id sport</i> <i>intf_name</i>	Deletes entries of the static source multicast.



The SVLAN mentioned here is the multicast source VLAN and the *vlan ID* of SVLAN cannot be that of represented VLAN.

31.1.1.5 Monitoring and Maintaining IGMP-Proxy

Run the following commands in EXEC mode:

Command	Operation
show ip igmp-proxy	Displays the information about IGMP proxy.
show ip igmp-proxy mcache [<i>delete</i> <i>nonsync</i> <i>sync</i> <i>static</i>]	Displays the forwarding cache of IGMP proxy. delete: display those entries of which hardware caches are deleted but software caches do not time out.

	<p>nonsync: display those entries that have been processed but not yet synchronized to the hardware cache..</p> <p>Sync: display those entries already in the hardware cache.</p> <p>All entries are to be displayed if no filtration conditions are specified.</p> <p>static: only display the entries of static multicast cache.</p>
<p>[no] debug ip igmp-proxy [error event packet]</p>	<p>Enables or disables the IGMP-proxy debug switch.</p>

The following example shows how to display the forwarding caches of IGMP proxy:

```
Switch# show ip igmp-proxy mcache
Codes: '+' synchronization, '-' deleted, 'S' static
      '^' unsynchronization

Item 1: Group 225.1.1.2
+(192.168.213.163, 2, G3/24)
VLAN 3,4
```

31.1.1.6 IGMP-Proxy Configuration Example

The network topology is shown in figure 1.

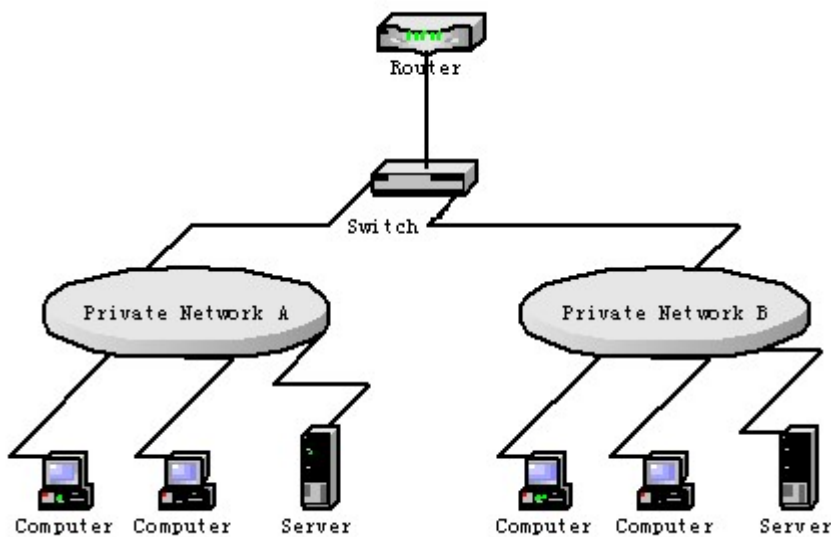

Switch configuration:

(1) Enable IGMP snooping and IGMP proxy.

```
Switch_config#ip igmp-snooping
```

```
Switch_config#ip igmp-proxy enable
```

(2) Add VLAN 2 as the agent VLAN of the represented VLAN 3.

```
Switch_config#ip igmp-proxy agent-vlan 2 client-vlan map 3
```

Chapter 32. MLD-Snooping Configuration

32.1 MLD-Snooping Configuration

32.1.1 IPv6 Multicast Overview

The task of MLD snooping is to maintain the forwarding relationship of IPv6 group addresses in VLAN and synchronize with the change of the multicast group, enabling the data to be forwarded according to the topology of the multicast group. Its functions include monitoring MLD-snooping packets, maintaining the table between group address and VLAN, keep the MLD-snooping host the same with the MLD-snooping router and solve the flooding problems.

When a L2 device has not got MLD snooping run, the multicast data will be broadcast at the second layer; when the L2 device gets MLD snooping run, the multicast data of the known multicast group will not be broadcast at the second layer but be sent to the designated receiver, and the unknown multicast data will be dropped.



Because MLD-snooping solves the above-mentioned problems by monitoring the Query or Report packets of MLD-Snooping, MLD snooping can work normally only when there exists the multicast router.

32.1.2 MLD-Snooping Multicast Configuration Tasks

- Enabling/Disabling MLD-Snooping
- Enabling/Disabling the Solicitation of Hardware Forward of Multicast Group
- Adding/Deleting the Static Multicast Address of VLAN
- Setting Router Age Timer of MLD-Snooping
- Setting Response Time Timer of MLD-Snooping
- Setting the Port of the Static Multicast Router
- Setting the Immediate Leave Function
- Monitoring and Maintaining MLD-Snooping

32.1.2.1 Enabling/Disabling MLD-Snooping Multicast

Run the following commands in global configuration mode.

Command	Purpose
ipv6 mld-snooping-snooping	Enables MLD snooping multicast.
no ipv6 mld-snooping-snooping	Disables MLD snooping.

After MLD-Snooping is enabled and the multicast packets fail to be found, the multicast packets whose destination addresses are not registered are dropped.

32.1.2.2 Enabling/Disabling the Solicitation of Hardware Forward of Multicast Group

Run the following commands in global configuration mode.

Command	Purpose
ipv6 mld-snooping solicitation	Enables the solicitation of hardware forward of multicast group.
no ipv6 mld-snooping solicitation	Disables the solicitation of hardware forward of multicast group.

32.1.2.3 Adding/Canceling the Static Multicast Address of VLAN

Run the following commands in global configuration mode.

Command	Purpose
ipv6 mld-snooping vlan <i>vlan_id</i> static <i>X</i> : <i>X</i> : <i>X</i> : <i>X</i> : : <i>X</i> interface <i>intf</i>	Adds the static multicast address of VLAN.
no ipv6 mld-snooping vlan <i>vlan_id</i> static <i>X</i> : <i>X</i> : <i>X</i> : <i>X</i> : : <i>X</i> interface <i>intf</i>	Removes the static multicast address of VLAN.

32.1.2.4 Setting Router Age Timer of MLD-Snooping

Run the following commands in global configuration mode.

Command	Operation
ipv6 mld-snooping timer router-age <i>timer_value</i>	Sets the router age of MLD-Snooping.
no ipv6 mld-snooping timer router-age	Resumes the default router age of MLD-Snooping.



The settings of this timer shall refer to the query period settings of MLD-Snooping and be larger than the query period. It is recommended to set the router age timer to be triple of the query period.

The default router age of MLD snooping is 260 seconds.

32.1.2.5 Setting Response Time Timer of MLD-Snooping

Run the following commands in global configuration mode.

Command	Operation
ipv6 mld-snooping timer	Sets the response time of MLD-Snooping.

response-time <i>timer_value</i>	
no ipv6 mld-snooping timer response-time	Resumes the default response time of MLD-Snooping.



The value of the timer cannot be set too small, or the multicast communication may be unstable.

The default response time of MLD snooping is 15 seconds.

32.1.2.6 Setting the Port of the Static Multicast Router

Run the following commands in global configuration mode.

Command	Operation
ipv6 mld-snooping vlan <i>WORD</i> mrouter interface <i>inft_name</i>	Sets the static multicast router's port of MLD snooping in Vlan word .
no ipv6 mld-snooping vlan <i>WORD</i> mrouter interface <i>inft_name</i>	Deletes the static multicast router's port of MLD snooping in Vlan word .

32.1.2.7 Enabling/Disabling Immediate Leave

Run the following commands in global configuration mode.

Command	Purpose
ipv6 mld-snooping vlan <i>WORD</i> immediate-leave	Enables the immediate-leave functionality.
no ipv6 mld-snooping vlan <i>WORD</i> immediate-leave	Resumes the default settings.

32.1.2.8 Monitoring and Maintaining MLD-Snooping Multicast

Run the following commands in EXEC mode:

Command	Operation
show ipv6 mld-snooping	Displays the configuration of MLD-Snooping.
show ipv6 mld-snooping timer	Displays the clock of MLD-Snooping.
show ipv6 mld -snooping groups	Displays the multicast group of MLD-Snooping.
show ipv6 mld-snooping statistics	Displays the statistics information of MLD-Snooping

show ipv6 mld-snooping vlan	Displays the configuration of MLD-Snooping in VLAN.
show ipv6 mld-snooping mac	Displays the multicast MAC addresses recorded by MLD snooping.

The MLD-Snooping information is displayed below:

```
#show ipv6 mld-snooping

Global MLD snooping configuration:
-----
Globally enable : Enabled
Querier       : Enabled
Querier address : FE80: : 3FF: FEFE: FD00: 1
Router age    : 260 s
Response time : 10 s
Handle Solicitation : Disabled

Vlan 1:
-----
Running
Routers: SWITCH(querier);
```

The multicast group of MLD-Snooping is displayed below:

```
#show ipv6 mld-snooping groups

Vlan Group   Type Port(s)
-----
1 FF02: : 1: FF32: 1B9B MLD G2/23
1 FF02: : 1: FF00: 2 MLD G2/23
1 FF02: : 1: FF00: 12 MLD G2/23
1 FF02: : 1: FF13: 647D MLD G2/23
2 FF02: : 1: FF00: 2 MLD G2/22
2 FF02: : 1: FF61: 9901 MLD G2/22
```

The timer of MLD-Snooping is displayed below:

#show ipv6 mld-snooping timers

vlan 1 Querier on port 0 : 251

#

Querier on port 0: 251 meaning the router age timer times out.

vlan 2 multicast address 3333.0000.0005 response time : This shows the time period from receiving a multicast query packet to the present; if there is no host to respond when the timer times out, the port will be canceled.

The MLD-snooping statistics information is displayed below:

#show ipv6 mld-snooping statistics

vlan 1

```

-----
v1_packets: 0    quantity of v1 packets
v2_packets: 6    quantity of v2 packets
v3_packets: 0    quantity of v3 packets
general_query_packets: 5  Quantity of general query packets
special_query_packets: 0  Quantity of special query packets
listener_packets: 6  Quantity of Report packets
    done_packets: 0  Quantity of Leave packets
    err_packets: 0  Quantity of error packets
    
```

The MLD-Snooping proxying is displayed below:

#show ipv6 mld-snooping mac

```

Vlan Mac      Ref Flags
-----
1 3333: 0000: 0001 1 2
2 3333: ff61: 9901 1 0
FF02: : 1: FF61: 9901
1 3333: 0000: 0002 1 2
1 3333: ff00: 0002 1 0
FF02: : 1: FF00: 2
1 3333: ff00: 0012 1 0
FF02: : 1: FF00: 12
1 3333: ff13: 647d 1 0
    
```

```
FF02: : 1: FF13: 647D
1 3333: ff32: 1b9b 1 0
FF02: : 1: FF32: 1B9B
2 3333: ff00: 0002 1 0
FF02: : 1: FF00: 2
1 3333: ff00: 0001 1 2
1 3333: ff8e: 7000 1 2
```

Chapter 33. OAM Configuration

33.1 OAM Configuration

33.1.1 OAM Overview

EFM OAM of IEEE 802.3ah provides point-to-point link trouble/performance detection on the single link. However, EFM OAM cannot be applied to EVC and so terminal-to-terminal Ethernet monitoring cannot be realized. OAM PDU cannot be forwarded to other interfaces. Ethernet OAM regulated by IEEE 802.3ah is a relatively slow protocol. The maximum transmission rate is 10 frames per second and the minimum transmission rate is 1 frame per second.

33.1.1.1 OAM Protocol's Attributes

- Supporting Ethernet OAM devices and OAM attributes

The Ethernet OAM connection process is called as the Discovery phase when the OAM entity finds the OAM entity of the remote device and a stable session will be established. During the phase, the connected Ethernet OAM entities report their OAM mode, Ethernet OAM configuration information and local-node-supported Ethernet OAM capacity to each other by interacting the information OAM PDU. If the loopback configuration, unidirectional link detection configuration and link-event configuration have been passed on the Ethernet OAM of the two terminals, the Ethernet OAM protocol will start working on the link layer.

- Link monitoring

The Ethernet OAM conducts the link monitoring through Event Notification OAM PDU. If the link has troubles and the local link monitors the troubles, the local link will transmits Event Notification OAM PDU to the peer Ethernet OAM to report the normal link event. The administrator can dynamically know the network conditions through link monitoring. The definition of a normal link event is shown in table 1.

Table 1 Definition of the normal link event

Normal Link Event	Definition
Period event of error signal	Specifies the signal number N as the period. The number of error signals exceeds the defined threshold when N signals are received.
Error frame event	The number of error frames exceeds the defined threshold during the unit time.
Period event of error frame	Specifies the frame number N as the period. The number of error frames exceeds the defined threshold when N frames are received.
Second frame of error	Specifies that the number of seconds of the error frame exceeds

frame

the defined threshold in the designated M second.

- Remote trouble indication

It is difficult to check troubles in the Ethernet, especially the case that the network performance slows down while physical network communication continues. OAM PDU defines a flag domain to allow Ethernet OAM entity to transmit the trouble information to the peer. The flag can stand for the following emergent link events:

- Link Fault: The physical layer detects that the reception direction of the local DTE has no effect. If troubles occur, some devices at the physical layer support unidirectional operations and allows trouble notification from remote OAM.
- Dying Gasp: If an irrecoverable local error occurs, such as OAM shutdown, the interface enters the **error-disabled** state and then is shut down.
- Critical Event: Uncertain critical events occur (critical events are specified by the manufacturer).

Information OAM PDU is continuously transmitted during Ethernet OAM connection. The local OAM entity can report local critical link events to remote OAM entity through Information OAM PDU. The administrator thus can dynamically know the link's state and handle corresponding errors in time.

- Remote loopback

OAM provides an optional link-layer-level loopback mode and conducts error location and link performance testing through non-OAM-PDU loopback. The remote loopback realizes only after OAM connection is created. After the OAM connection is created, the OAM entity in active mode triggers the remote loopback command and the peer entity responses the command. If the remote terminal is in loopback mode, all packets except OAM PDU packets and Pause packets will be sent back through the previous paths. Error location and link performance testing thus can be conducted. When remote DTE is in remote loopback mode, the local or remote statistics data can be queried and compared randomly. The query operation can be conducted before, when or after the loopback frame is transmitted to the remote DTE. Regular loopback check can promptly detect network errors, while segmental loopback check can help locating these network errors and then remove these errors.

- Round query of any MIB variables described in chapter 30 of 802.3.

33.1.1.2 OAM Mode

The device can conduct the OAM connection through two modes: active mode and passive mode. The device capacity in different mode is compared in table 2. Only OAM entity in active mode can trigger the connection process, while the OAM entity in passive mode has to wait for the connection request from the peer OAM entity. After the remote OAM discovery process is done, the local entity in active mode can transmit any OAM PDU packet if the remote entity is in active mode, while the local entity's operation in active mode will be limited if the remote entity is in passive mode. This is because the device in active mode does not react on remote loopback commands and variable requests transmitted by the passive remote entity.

Table 2 Comparing device capacity in active and passive modes

Capacity	Active Mode	Passive Mode
Initializing the Ethernet OAM discovery process	Yes	No
Responding to the OAM discovery initialization process	Yes	Yes
Transmitting the Information OAM PDU packet	Yes	Yes
Permitting to transmit the Event Notification OAM PDU packet	Yes	Yes
Allowing to transmit the Variable Request OAM PDU packet	Yes	No
Allowing to transmit Variable Response OAM PDU packet	Yes	Yes
Allowing to transmit the Loopback Control OAM PDU packet	Yes	No
Responding to Loopback Control OAM PDU	Yes , but the peer terminal must be in active mode.	Yes
Allowing to transmit specified OAM PDU	Yes	Yes

After the Ethernet OAM connection is established, the OAM entities at two terminals maintain connection by transmitting the Information OAM PDU packets. If the Information OAM PDU packet from the peer OAM entity is not received in five seconds, the connection times out and a new OAM connection then requires to be established.

33.1.1.3 Components of the OAM Packet

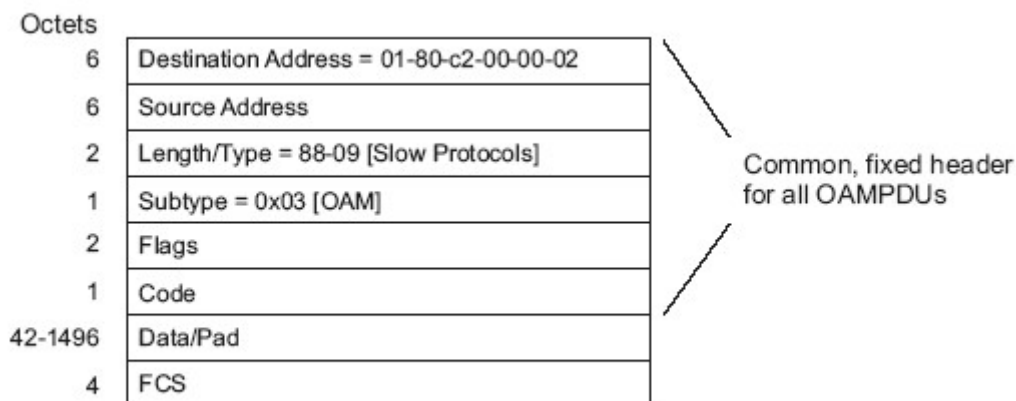

Figure 57-9—OAMPDU frame structure

Figure 1 Components of the OAM packet

The following are the meanings of the fields of the OAM packet:

- Destination address: means the destination MAC address of the Ethernet OAM packet.

- Source address: Source MAC address of the Ethernet OAM packet
It is the MAC address of the transmitter terminal's port and also a unicast MAC address.
- Length/Type: Always adopts the Type encoding. The protocol type of the Ethernet OAM packet is 0x8809.
- Subtype: The subtype of the protocol for Ethernet OAM packets is 0x03.
- Flags: a domain where the state of Ethernet OAM entity is shown
- Code: a domain where the type of the OAMPDU packet is shown
- Data/Pad: a domain including the OAMPDU data and pad values
- FCS: checksum of the frame

Table 3 Type of the CODE domain

CODE	OAMPDU
00	Information
01	Event Notification
02	Variable Request
03	Variable Response
04	Loopback Control
05-FD	Reserved
FE	Organization Specific
FF	Reserved

The Information OAM PDU packet is used to transmit the information about the state of the OAM entity to the remote OAM entity to maintain the OAM connection.

The Event Notification OAMPDU packet is used to monitor the link and report the troubles occurred on the link between the local and remote OAM entities.

The Loopback control OAMPDU packet is mainly used to control the remote loopback, including the state of the OAM loopback from the remote device. The packet contains the information to enable or disable the loopback function. You can open or shut down the remote loopback according to the contained information.

33.1.2 OAM Configuration Task List

- Enabling OAM on an interface
- Enabling remote OAM loopback
- Configuring OAM link monitoring
- Configuring the trouble notification from remote OAM entity
- Displaying the information about OAM protocol

33.1.3 OAM Configuration Tasks

33.1.3.1 Enabling OAM on an Interface

Run the following command to enable OAM:

Procedure	Command	Purpose
Step1	config	Enters the global configuration mode.
Step2	interface intf-type intf-id	Enters the interface configuration mode.
Step3	ethernet oam	Enables Ethernet OAM on an interface.
Step4	ethernet oam [max-rate oampdus min-rate seconds mode { active passive } timeout seconds]	Configures optional OAM parameters: <ul style="list-style-type: none"> ● The max-rate parameter is used to configure the maximum number of OAMPDUs transmitted per second. It ranges between 1 and 10 and its default value is 10. ● The min-rate parameter is used to configure the minimum transmission rate of OAMPDU. Its unit is second. It ranges between 1 and 10 and its default value is 1. ● The mode {active passive} parameter is used to set the mode of OAM. The OAM connection can be established between two interfaces only when at least one interface is in active mode. ● The timeout parameter is used to set the timeout time of the OAM connection. It ranges between 1 and 30 seconds and its default value is 1 second.

You can run **no Ethernet oam** to shut down the OAM function.

The remote OAM loopback cannot be enabled on the physical interface that belongs to the aggregation interface.

33.1.3.2 Enabling Remote OAM Loopback

The procedure to enable remote loopback on an interface is shown in the following table:

Procedure	Command	Purpose
Step1	config	Enters the global configuration mode.
Step2	interface intf-type intf-id	Enters the interface configuration mode.
Step3	ethernet oam remote-loopback { supported timeout seconds}	Configures optional loopback parameters from the remote OAM: <ul style="list-style-type: none"> ● The supported parameter is used to enable an interface to support the remote loopback of Ethernet OAM. Remote loopback is not supported by

		<p>default.</p> <ul style="list-style-type: none"> The timeout parameter is used to configure the timeout time of remote loopback. It ranges between 1 and 10 and its default value is 2.
Step4	exit	Exits from interface configuration mode.
Step5	exit	Exits from the global configuration mode.
Step6	ethernet oam remote-loopback {start stop} interface intf-type intf-id	Enables or disables remote loopback on an interface.

The remote OAM loopback cannot be enabled on the physical interface that belongs to the aggregation interface.

33.1.3.3 Configuring OAM Link Monitoring

You can configure the low threshold and the high threshold of OAM link monitoring.

The procedure to configure the OAM link monitoring on an interface is shown in the following table:

Procedure	Command	Purpose
Step1	config	Enters the global configuration mode.
Step2	interface intf-type intf-id	Enters the interface configuration mode.
Step3	ethernet oam link-monitor supported	Enables link monitoring on an interface. The link monitoring is supported by default.
Step4	ethernet oam link-monitor symbol-period {threshold {high { symbols none} low {symbols}} window symbols}	<p>Sets the high and low threshold of the periodical event of the error signal, which triggers the error link events.</p> <p>The threshold high parameter is used to configure the high threshold. Its unit is signal number. It ranges between 1 and 65535 and its default value is none.</p> <p>The threshold low parameter is used to configure the low threshold. Its unit is signal number. It ranges between 0 and 65535 and its default value is 1.</p> <p>The window parameter is used to configure the window size of the round-query period. The unit of the window size is the number of the 100M signal. The window size ranges between 10 and 600 on a 1000M Ethernet interface and its default value is 10 in this</p>

		<p>case, while the window size ranges between 1 and 60 on a 100M Ethernet interface and its default value is 1 in this case.</p>
Step5	<p>ethernet oam link-monitor frame {threshold {high { symbols none} low {symbols}} window symbols}</p>	<p>Sets the high and low thresholds of the error frame event, which triggers the link events of error frame.</p> <p>The threshold high parameter is used to configure the high threshold. Its unit is signal number. It ranges between 1 and 65535 and its default value is none.</p> <p>The threshold high parameter is used to configure the low threshold. Its unit is signal number. It ranges between 0 and 65535 and its default value is 1.</p> <p>The window parameter is used to configure the window size of the round-query period. Its unit is second. It ranges between 1 and 60 and its default value is 1.</p>
Step6	<p>ethernet oam link-monitor frame-period {threshold {high { symbols none} low {symbols}} window symbols}</p>	<p>Sets the high and low thresholds of the period event of error frame, which triggers the link events of error frame period.</p> <p>The threshold high parameter is used to configure the high threshold. Its unit is signal number. It ranges between 1 and 65535 and its default value is none.</p> <p>The threshold high parameter is used to configure the low threshold. Its unit is signal number. It ranges between 0 and 65535 and its default value is 1.</p> <p>The window parameter is used to configure the window size of the round-query period. The unit of the window size is the number of the 14881 frames. The window size ranges between 100 and 6000 on a 1000M Ethernet interface and its default value is 100 in this case, while the window size ranges between 10 and 600 on a 100M Ethernet interface and its default value is 10 in this case.</p>

<p>Step7</p>	<p>ethernet oam link-monitor frame-seconds {threshold {high { symbols none} low {symbols}} window symbols}</p>	<p>Sets the high and low thresholds of the second event of error frame, which triggers the link events of error frame's second.</p> <p>The threshold high parameter is used to configure the high threshold. Its unit is signal number. It ranges between 1 and 900 and its default value is none.</p> <p>The threshold low parameter is used to configure the low threshold. Its unit is signal number. It ranges between 0 and 900 and its default value is 1.</p> <p>The window parameter is used to configure the window size of the round-query period. Its unit is second. It ranges between 10 and 900 and its default value is 60.</p>
<p>Step8</p>	<p>ethernet oam link-monitor receive-crc {threshold {high { symbols none} low {symbols}} window symbols}</p>	<p>Sets the high and low thresholds of the error CRC frame event, which triggers the link events of CRC checksum error.</p> <p>The threshold high parameter is used to configure the high threshold. Its unit is signal number. It ranges between 1 and 65535 and its default value is none.</p> <p>The threshold low parameter is used to configure the low threshold. Its unit is signal number. It ranges between 0 and 65535 and its default value is 1.</p> <p>The window parameter is used to configure the window size of the round-query period. Its unit is second. It ranges between 1 and 180 and its default value is 10.</p>
<p>Step9</p>	<p>ethernet link-monitor on</p>	<p>Enables the local link monitoring. When the link monitoring function is supported, the local link monitoring is automatically enabled.</p>

33.1.3.4 Configuring the Trouble Notification From Remote OAM Entity

You can configure an **error-disable** action on an interface. The local interface will enter the errdisabled state in the following cases:

1. The high threshold of a normal link event on a local interface is exceeded.

2. The remote interface which connects the local interface enters the **errdisabled** state.
3. The OAM function on the remote interface which connects the local interface is shut down by the administrator.

The procedure to configure the remote OAM trouble indication on an interface is shown in the following table:

Procedure	Command	Purpose
Step1	config	Enters the global configuration mode.
Step2	interface intf-type intf-id	Enters the interface configuration mode.
Step3	ethernet oam remote-failure {critical-event dying-gasp link-fault} action error-disable-interface	Configures the trigger action of a remote OAM trouble on an interface: <ul style="list-style-type: none"> ● The critical-event parameter is used to enable an interface to enter the errdisabled state when an undesignated critical event occurs. ● The dying-gasp parameter is used to enable the local interface to enter the errdisabled state if the high threshold of a normal link event on a local interface is exceeded or if the remote interface which connects the local interface enters the errdisabled state or if the OAM function on the remote interface which connects the local interface is shut down by the administrator. ● The link-fault parameter is used to enable an interface to enter the errdisabled state when the receiver detects signal loss.

The managed switch cannot generate the LINK FAULT packets and the Critical Event packets. However, these packets will be handled if they are received from the remote terminal. Our router can transmit and receive the Dying Gasp packet. When the local port enters the **errdisabled** state or is closed by the administrator or the OAM function of the local port is closed by the manager, the Dying Gasp packet will be transmitted to the remote terminal that connects the local port.

33.1.3.5 Displaying the Information About OAM Protocol

Table 4 Displaying the information about OAM protocol

Command	Purpose
show ethernet oam discovery interface [intf-type intf-id]	Displays the OAM discovery information on all interfaces or a designated interface.

<p>show ethernet oam statistics {pdu link-monitor remote-failure} interface [intf-type intf-id]</p>	<p>Displays the OAM statistics information on all interfaces or a designated interface.</p> <ul style="list-style-type: none"> ● The pdu parameter is used to classify and count the OAM packets according to the code-domain value of the OAM packet. ● The link-monitor parameter is used to display the detailed statistics information of normal link events. ● The remote-failure parameter is to display the detailed statistics information about the remote trouble.
<p>show ethernet oam configuration interface [intf-type intf-id]</p>	<p>Displays the OAM configuration information on all interfaces or a designated interface.</p>
<p>show ethernet oam runtime interface [intf-type intf-id]</p>	<p>Displays the OAM running information on all interfaces or a designated interface.</p>

33.1.4 Configuration Example

33.1.4.1 Network Environment Requirements

You need configure the OAM protocol on the interface where two managed switches connect for capturing the information about managed switch receiving error frames on user access side.

33.1.4.2 Network Topology

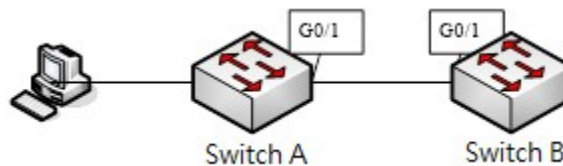

Figure 2 Network topology

33.1.4.3 Configuration Procedure

Configuring switch A:

```
Switch_config_g0/1#ethernet oam
Switch_config_g0/1#ethernet oam mode passive
Switch_config_g0/1#ethernet oam link-monitor frame threshold low 10
Switch_config_g0/1#ethernet oam link-monitor frame window 30
Switch_config_g0/1#show ethernet oam configuration int g0/1
GigaEthernet0/1
General
-----
```

Admin state : enabled
Mode : passive
PDU max rate : 10 packets/second
PDU min rate : 1 seconds/packet
Link timeout : 1 seconds
High threshold action: no action

Remote Failure

Link fault action : no action
Dying gasp action : no action
Critical event action: no action

Remote Loopback

Is supported : not supported
Loopback timeout : 2

Link Monitoring

Negotiation : supported
Status : on

Errored Symbol Period Event

Window : 10 * 100M symbols
Low threshold : 1 error symbol(s)
High threshold : none

Errored Frame Event

Window : 30 seconds
Low threshold : 10 error frame(s)
High threshold : none

Errored Frame Period Event

Window : 100 * 14881 frames
Low threshold : 1 error frame(s)
High threshold : none

Errored Frame Seconds Summary Event

Window : 60 seconds

Low threshold : 1 error second(s)

High threshold : none

Errored CRC Frames Event

Window : 1 seconds

Low threshold : 10 error frame(s)

High threshold : none

Configuring switch B:

```
Switch_config_g0/1#ethernet oam
```

```
Switch_config_g0/1#show ethernet oam statistics link-monitor int g0/1
```

```
GigaEthernet0/1
```

Local Link Events:

Errored Symbol Period Event:

No errored symbol period event happened yet.

Errored Frame Event:

No errored frame event happened yet.

Errored Frame Period Event:

No errored frame period event happened yet.

Errored Frame Seconds Summary Event:

No errored frame seconds summary event happened yet.

Errored CRC Frames Event:

No errored CRC frame event happened yet.

Remote Link Events:

Errored Symbol Period Event:

No errored symbol period event happened yet.

Errored Frame Event:

No errored frame event happened yet.

Errored Frame Period Event:

No errored frame period event happened yet.

Errored Frame Seconds Summary Event:

No errored frame seconds summary event happened yet.

Errored CRC Frames Event:

No errored CRC frame event happened yet.

Chapter 34. CFM and Y1731 Configuration

34.1 Overview

34.1.1 Stipulations

34.1.1.1 Format Stipulation in the Command Line

Syntax	Meaning
Bold	Stands for the keyword in the command line, which stays unchanged and must be entered without any modification. It is presented as a bold in the command line.
<i>{italic}</i>	Stands for the parameter in the command line, which must be replaced by the actual value. It must be presented by the italic in the brace.
< <i>italic</i> >	Stands for the parameter in the command line, which must be replaced by the actual value. It must be presented by the italic in the point bracket.
[]	Stands for the optional parameter, which is in the square bracket.
{ x y ... }	Means that you can choose one option from two or more options.
[x y ...]	Means that you can choose one option or none from two or more options.
{ x y ... } *	Means that you has to choose at least one option from two or more options, or even choose all options.
[x y ...] *	Means that you can choose multiple options or none from two or more options.
&<1-n>	Means that the parameter before the “&” symbol can be entered <i>n</i> times.
#	Means that the line starting with the “#” symbol is an explanation line.

34.2 CFM Configuration

34.2.1 CFM Configuration Task List

- Adding the Maintenance Domain
- Adding the Maintenance Association
- Adding MIP (Maintenance domain Intermediate Point)
- Adding MEP (Maintenance association End Point)
- Starting CFM

34.2.2 CFM Maintenance Task List

- Using the Loopback Function
- Using the Linktrace Function

34.2.3 CFM Configuration

34.2.3.1 Adding the Maintenance Domain

Configuration mode: Global

Command	Purpose
ethernet cfm md mdnf {string} mdn <char_string> [level <0-7> creation <MHF_creation_type> sit <sender_id_type> ip <IP_address>]	Adds a maintenance domain whose name is char_string . Note: The system enters the maintenance domain configuration mode after the maintenance domain is added.

34.2.3.2 Adding the Maintenance Association

Configuration mode: maintenance domain

Command	Purpose
ma manf {string} man <char_string> ci {100ms 1s 10s 1min 10min} meps <mepids> [vlan <1-4094> creation <MHF_creation_type> sit <sender_id_type> ip <IP_address>]	Adds a maintenance association whose name is char_string .

34.2.3.3 Adding MIP (Maintenance Domain Intermediate Point)

Configuration mode: physical interface

Command	Purpose
ethernet cfm mip add level <0-7>[vlan <1-4094>]	Adds a designated VLAN and hierarchical MIP to the designated physical interface.

34.2.3.4 Adding MEP (Maintenance association End Point)

Configuration mode: physical interface

Command	Purpose
ethernet cfm mep add mdnf {string} mdn <char_string> manf {string} man <char_string> mepid <1-8191>[direction {up down} ip <ip_address>]	Adds a designated maintenance domain and an MEP to the designated physical interface.

34.2.3.5 Starting CFM

Configuration mode: Global

Command	Purpose
ethernet cfm {enable}	Starts CFM.

34.2.4 CFM Maintenance

34.2.4.1 Using the Loopback Function

Configuration mode: EXEC

Command	Purpose
ethernet cfm loopback mdnf {string} mdn <char_string> manf {string} man <char_string> mepid <1-8191> mac <AA: BB: CC: DD: EE: FF> number <1-64>	Uses a designated MEP to conduct loopback towards itself.

34.2.4.2 Using the Linktrace Function

Configuration mode: EXEC

Command	Purpose
ethernet cfm linktrace mdnf {string} mdn <char_string> manf {string} man <char_string> mepid <1-8191> mac <AA: BB: CC: DD: EE: FF> [ttl {1-255} fdb-only {yes}]<char_string> manf {string} man <char_string> mepid <1-8191>mac <AA: BB: CC: DD: EE: FF>ttl <1-255>	Uses a designated MEP to conduct loopback towards itself.

34.2.5 Configuration Example

You want to add a maintenance domain whose name is customer and hierarchy is 5, set a customer1 maintenance association for vlan1, configure the transmission interval of CCM of the maintenance association to 1s and add an MEP whose MEPID is 2009 to physical port1.

```
Switch_config#ethernet cfm md mdnf string mdn customer level 5
```

```
Switch_config_cfm#ma manf string man customer1 vlan 1 ci 1s meps 1-2,2009
```

```
Switch_config_cfm#interface g0/1
```

```
Switch_config_g0/1#ethernet cfm mep add mdnf string mdn customer manf string man customer1 mepid 2009 direction DOWN
```

```
Switch_config_g0/1#exit
```

Switch_config#ethernet cfm enable

34.3 Y1731 Configuration

34.3.1 Configuration Task List

- Specifying an MEP to Forward AIS Frame
- Enabling Frame Delay Measurement
- Displaying the Information About OAM Protocol

34.3.1.1 Specifying an MEP to Forward AIS Frame

Run the following commands specify an MEP to transmit AIS frames:

Procedure	Command	Purpose
Step1	config	Enters the global configuration mode.
Step2	ethernet y1731 ais-mep timer <i>time</i>	Designates the transmission interval of AIS packets. <1> -- 1 frame per second <2> -- 1 frame per minute The default transmission value is 1 second.
Step3	interface intf-type intf-id	Enters the interface configuration mode.
Step4	ethernet y1731ais-mep <i>MEGID</i> <i>MEPID</i>	Specifies an MEP to transmit AIS frames. MEGID is the name of MEG to which MEP belongs. MEPID is the identifier of the specified MEP.

You can run **noethernet y1731 ais-mep timer** to resume the default transmission period of AIS frames and run **no ethernet y1731 ais-mep MEGID MEPID** to delete AIS transmitter, MEP.

34.3.1.2 Displaying the Information About OAM Protocol

Run show to browse Y1731 configuration:

Command	Purpose
show ethernet y1731 ais-mep	The above-mentioned command is used to show the MEPs that can transmit AIS frames.
show ethernet y1731 detect <i>MEGID</i> [<i>MEPID</i>]	The above-mentioned command is used to display the detection information about the continuous check of MEG, including whether continuity is lost or whether other faults occur. MEGID is the name of MEG.

	MEPID is the symbol of to-be-displayed MEP.
show ethernet y1731 interface <i>interface-name</i>	Displaying MEP and MIP Configurations on a Port interface-name stands for port identifier.
show ethernet y1731 meglist [MEGID]	The above-mentioned command is used to display the configuration of all MEG or the detailed configuration about a certain MEG. MEGID is the name of to-be-displayed MEG.
show ethernet y1731 miplist	The above-mentioned command is used to display the information about all configured MIPs.
show ethernet y1731 traffic	The above-mentioned command is used to display some statistics information about the Y.1731 module, including statistics of the received and transmitted OAM packets and the system error.

34.3.1.3 Deleting Y1731 Configuration or Statistics Information

Run **clear** to browse Y1731 configuration and statistics information:

Command	Purpose
clear ethernet y1731 counters	The above-mentioned command is used to delete the transmission statistics information about the OAM packets and the system error information.

Chapter 35. DHCP-Snooping Configuration

35.1 DHCP-Snooping Configuration

35.1.1 DHCP-Snooping Configuration Tasks

DHCP-Snooping is to prevent the fake DHCP server from providing the DHCP service by judging the DHCP packets, maintaining the binding relationship between MAC address and IP address. The L2 switch can conduct the DAI function and the IP source guard function according to the binding relationship between MAC address and IP address. The DHCP-snooping is mainly to monitor the DHCP packets and dynamically maintain the MAC-IP binding list. The L2 switch filters the packets, which do not meet the MAC-IP binding relationship, to prevent the network attack from illegal users.

- Enabling/Disabling DHCP-snooping
- Enabling DHCP-snooping in a VLAN
- Setting an interface to a DHCP-trusting interface
- Enabling DAI in a VLAN
- Setting an interface to an ARP-trusting interface
- Enabling source IP address monitoring in a VLAN
- Setting an interface to the one which is trusted by IP source address monitoring
- Configuring the TFTP server for backing up DHCP-snooping binding
- Configuring a file name for DHCP-snooping binding backup
- Configuring an interval for DHCP-snooping binding backup
- Configuring or adding the binding relationship manually
- Monitoring and maintaining DHCP-snooping
- Examples for DHCP-snooping configuration

35.1.1.1 Enabling/Disabling DHCP-Snooping

Run the following commands in global configuration mode.

Command	Purpose
ip dhcp-relay snooping	Enables DHCP snooping.
no ip dhcp-relay snooping	Resumes the default settings.

This command is used to enable DHCP snooping in global configuration mode. After this command is run, the switch is to monitor all DHCP packets and form the corresponding binding relationship.



If the client obtains the address of a switch before this command is run, the switch cannot add the corresponding binding relationship.

35.1.1.2 Enabling DHCP-Snooping in a VLAN

If DHCP snooping is enabled in a VLAN, the DHCP packets which are received from all distrusted physical ports in a VLAN will be legally checked. The DHCP response packets which are received from distrusted physical ports in a VLAN will then be dropped, preventing the faked or mis-configured DHCP server from providing address distribution services. For the DHCP request packet from distrusted ports, if the hardware address field in the DHCP request packet does not match the MAC address of this packet, the DHCP request packet is then thought as a fake packet which is used as the attack packet for DHCP DOS and then the switch will drop it.

Run the following commands in global configuration mode.

Command	Purpose
ip dhcp-relay snoopingvlan <i>vlan_id</i>	Enables DHCP-snooping in a VLAN.
no ip dhcp-snooping vlan <i>vlan_id</i>	Disables DHCP-snooping in a VLAN.

35.1.1.3 Setting an Interface to a DHCP-Trusting Interface

If an interface is set to be a DHCP-trusting interface, the DHCP packets received from this interface will not be checked.

Run the following commands in physical interface configuration mode.

Command	Purpose
dhcp snooping trust	Sets an interface to a DHCP-trusting interface.
no dhcp snooping trust	Resumes an interface to a DHCP-distrusted interface.

The interface is a distrusted interface by default.

35.1.1.4 Enabling DAI in a VLAN

When dynamic ARP monitoring is conducted in all physical ports of a VLAN, a received ARP packet will be rejected if the source MAC address and the source IP address of this packet do not match up with the configured MAC-IP binding relationship. The binding relationship on an interface can be dynamically bound by DHCP or configured manually. If no MAC addresses are bound to IP addresses on a physical interface, the switch rejects forwarding all ARP packets.

Command	Purpose
ip arp inspection vlan <i>vlanid</i>	Enables dynamic ARP monitoring on all distrusted ports in a VLAN.
no ip arp inspection vlan <i>vlanid</i>	Disables dynamic ARP monitoring on all distrusted ports in a VLAN.

35.1.1.5 Setting an Interface to an ARP-Trusting Interface

ARP monitoring is not enabled on those trusted interfaces. The interfaces are distrusted ones by default. Run the following commands in interface configuration mode.

Command	Purpose
arp inspection trust	Sets an interface to an ARP-trusting interface.
no arp inspection trust	Resumes an interface to an ARP-distrusting interface.

35.1.1.6 Enabling Source IP Address Monitoring in a VLAN

After source IP address monitoring is enabled in a VLAN, IP packets received from all physical ports in the VLAN will be rejected if their source MAC addresses and source IP addresses do not match up with the configured MAC-to-IP binding relationship. The binding relationship on an interface can be dynamically bound by DHCP or configured manually. If no MAC addresses are bound to IP addresses on a physical interface, the switch rejects forwarding all IP packets received from the physical interface.

Run the following commands in global configuration mode.

Command	Purpose
ip verify source vlan <i>vlanid</i>	Enables source IP address checkup on all distrusted interfaces in a VLAN.
no ip verify source vlan <i>vlanid</i>	Disables source IP address checkup on all interfaces in a VLAN.



If the DHCP packet (also the IP packet) is received, it will be forwarded because global snooping is configured.

35.1.1.7 Setting an Interface to the One Which is Trusted by IP Source Address Monitoring

Source address checkup is not enabled on an interface if the interface has a trusted source IP address. Run the following commands in interface configuration mode.

Command	Purpose
ip-source trust	Sets an interface to the one with a trusted source IP address.
no ip-source trust	Resumes an interface to the one with a distrusted source IP address.

35.1.1.8 Configuring the TFTP Server for Backing up Interface Binding

After the switch configuration is rebooted, the previously-configured interface binding will be lost. In this case, there is no binding relationship on this interface. After source IP address monitoring is enabled, the switch rejected forwarding all IP packets. After the TFTP server is configured for interface binding backup, the binding relationship will be backed up to the server through the TFTP protocol. After the switch is restarted, the switch automatically downloads the binding list from the TFTP server, securing the normal running of the network.

Run the following commands in global configuration mode.

Command	Purpose
ip dhcp-relay snooping database-agent <i>ip-address</i>	Configures the IP address of the TFTP server which is to back up interface binding.
no ip dhcp-relay snooping database-agent	Cancels the TFTP Server for backing up interface binding.

35.1.1.9 Configuring a File Name for Interface Binding Backup

When backing up the interface binding relationship, the corresponding file name will be saved on the TFTP server. In this way, different switches can back up their own interface binding relationships to the same TFTP server.

Run the following commands in global configuration mode.

Command	Purpose
ip dhcp-relay snooping db-file <i>name</i>	Configures a file name for interface binding backup.
no ip dhcp-relay snooping db-file	Cancels a file name for interface binding backup.

35.1.1.10 Configuring the Interval for Checking Interface Binding Backup

The MAC-to-IP binding relationship on an interface changes dynamically. Hence, you need check whether the binding relationship updates after a certain interval. If the binding relationship updates, it need be backed up again. The default interval is 30 minutes.

Run the following commands in global configuration mode.

Command	Purpose
ip dhcp-relay snooping write <i>num</i>	Configures the interval for checking interface binding backup.
no ip dhcp-relay snooping	Resumes the interval of checking interface binding

write	backup to the default settings.
-------	---------------------------------

35.1.1.11 Configuring Interface Binding Manually

If a host does not obtain the address through DHCP, you can add the binding item on an interface of a switch to enable the host to access the network. You can run **no ip source binding MAC IP** to delete items from the corresponding binding list.

Note that the manually-configured binding items have higher priority than the dynamically-configured binding items. If the manually-configured binding item and the dynamically-configured binding item have the same MAC address, the manually-configured one updates the dynamically-configured one. The interface binding item takes the MAC address as the unique index.

Run the following commands in global configuration mode.

Command	Purpose
ip source binding <i>MAC IP</i> interface <i>name</i>	Configures interface binding manually.
no ip source binding <i>MAC IP</i>	Cancels an interface binding item.

35.1.1.12 L2 Switch Forwarding DHCP Packets

The following command can be used to forward the DHCP packets to the designated DHCP server to realize DHCP relay. The negative form of this command can be used to shut down DHCP relay.



This command can only be used to enable DHCP relay on L2 switches, while on L3 switches, DHCP relay is realized by the DHCP server.

Run the following commands in global configuration mode.

Command	Purpose
ip dhcp-relay agent	Enables DHCP relay.
ip dhcp-relay helper-address <i>address</i> vlan <i>vlan-id</i>	Configures the destination address and VLAN of the relay.

35.1.1.13 Monitoring and Maintaining DHCP-Snooping

Run the following commands in EXEC mode:

Command	Purpose
show ip dhcp-relay snooping	Displays the information about DHCP-snooping configuration.
show ip dhcp-relay snooping binding	Displays the effective address binding items

	on an interface.
show ip dhcp-relay snooping binding all	Displays all binding items which are generated by DHCP snooping.
[no] debug ip dhcp-relay [snooping binding event]	Enables or disables the switch of DHCP relay snooping.

The following shows the information about the DHCP snooping configuration:

```
switch#show ip dhcp-relay snooping
ip dhcp-relay snooping vlan 3
ip arp inspection vlan 3
DHCP Snooping trust interface:
FastEthernet0/1
ARP Inspect interface:
FastEthernet0/11
```

The following shows the binding information about dhcp-relay snooping:

```
switch#show ip dhcp-relay snooping binding
Hardware Address  IP Address  remainder time Type      VLAN  interface
a8-f7-e0-26-23-89 192.2.2.101  86400    DHCP_SN    3    FastEthernet0/3
```

The following shows all binding information about dhcp-relay snooping:

```
switch#show ip dhcp-relay snooping binding all
Hardware Address  IP Address  remainder time Type      VLAN  interface
a8-f7-e0-32-1c-59 192.2.2.1  infinite  MANUAL    1    FastEthernet0/2
a8-f7-e0-26-23-89 192.2.2.101  86400    DHCP_SN    3    FastEthernet0/3
```

The following shows the information about dhcp-relay snooping.

```
switch#debug ip DHCP-snooping packet
DHCP-PR: receive l2 packet from vlan 3, diID: 3
DHCP-PR: DHCP packet len 277
DHCP-PR: add binding on interface FastEthernet0/3
DHCP-PR: send packet continue
DHCP-PR: receive l2 packet from vlan 3, diID: 1
```



```

DHCPR: DHCP packet len 300
DHCPR: send packet continue
DHCPR: receive l2 packet from vlan 3, diID: 3
DHCPR: DHCP packet len 289
DHCPR: send packet continue
DHCPR: receive l2 packet from vlan 3, diID: 1
DHCPR: DHCP packet len 300
DHCPR: update binding on interface FastEthernet0/3
DHCPR: IP address: 192.2.2.101, lease time 86400 seconds
DHCPR: send packet continue
    
```

35.1.1.14 Example of DHCP-Snooping Configuration

The network topology is shown in figure 1.

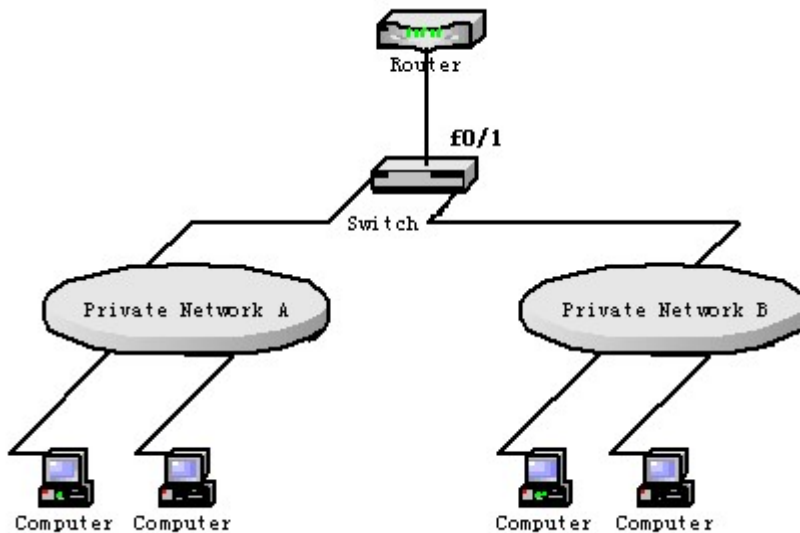

Figure 1 Configuring Switch

(1) Enable DHCP snooping in VLAN 1 which connects private network A.

```

Switch_config# ip dhcp-relay snooping
Switch_config# ip dhcp-relay snooping vlan 1
    
```

(2) Enable DHCP snooping in VLAN 2 which connects private network B.

```

Switch_config# ip dhcp-relay snooping
Switch_config# ip dhcp-relay snooping vlan 2
    
```

(3) Sets the interface which connects the DHCP server to a DHCP-trusting interface.

```

Switch_config_f0/1# dhcp snooping trust
    
```

Chapter 36. MACFF Configuration

36.1 MACFF Settings

36.1.1 Configuration Tasks

MACFF is to isolate downlink ports of the same VLAN in a switch from exchanging inter-access packets, enabling these packets to be allocated to the default gateway of client through DHCP server and then to downlink ports. By capturing the ARP packets between downlink ports, MACFF can prevent downlink ports from learn ARPs; MACFF replies the gateway's MAC address, enabling all inter-access packets among all downlink ports to pass through the gateway.

MACFF needs the support of DHCP Snooping, so before enabling MACFF you have to make sure that DHCP Snooping works normally. ICMP redirection on the gateway is closed by default. The VLAN management address must be configured



for MACFF-enabled switch.

- Enabling or Disabling MACFF
- Enabling MACFF in VLAN
- Configuring the Default AR of MACFF in VLAN
- Configuring other ARs of MACFF in VLAN
- Specifying a Physical Port to Shut down MACFF

36.1.1.1 Enabling/Disabling MVC

Run the following commands in global configuration mode.

Command	Purpose
macff enable	Enables MACFF.
no macff enable	Resumes the default settings.

This command is used to enable MACFF in global configuration mode. After this command is run, all ARP packets are listened by switch.



You have to make sure that DHCP Snooping is enabled before configuring this command. If the client obtains the address of a switch before this command is run, the switch cannot add the corresponding binding relationship.

36.1.1.2 Enabling MACFF in VLAN

If MACFF is enabled in a VLAN, the DHCP packets which are received from all DHCP-snooping untrusted physical ports in a VLAN will be legally checked.

If the destination IP address is the IP address of any DHCP client, on which the physical port that receives the ARP packets is located, these ARP packets will be dropped; if these are ARP response packets, these

packets will also be dropped.



The VLAN on which MACFF is enabled must be configured to have a management address. DHCP snooping shall also be enabled on this VLAN.

Run the following commands in global configuration mode.

Command	Purpose
macffvlan <i>vlan_id</i> enable	Enables MACFF in a VLAN.
no macffvlan <i>vlan_id</i> enable	Disables MACFF in a VLAN.

36.1.1.3 Configuring the Default AR of MACFF in VLAN

When you set the address on client manually, the switch shall automatically enables default AR as the MACFF-specified default gateway. There is only one default AR.

Run the following commands in global configuration mode.

Command	Purpose
macffvlan <i>vlan_id</i> default-ar <i>A.B.C.D</i>	Sets the default AR of MACFF in VLAN.
no macff vlan <i>vlan_id</i> default-ar <i>A.B.C.D</i>	Deletes the default AR of MACFF in VLAN.



Before configuring this command, you can run **ip source binding *xx-xx-xx-xx-xx-xxA.B.C.D interface name*** to add the client binding table on the switch. If you do not do this, MACFF will regard the manually configured client as illegal client and MACFF will not serve this client.

36.1.1.4 Configuring Other ARs of MACFF in VLAN

After other ARs of MACFF are configured, MACFF allows DHCP client to access these ARs directly without forwarding packets via the default gateway allocated by DHCP server.

This function can be applied on some servers in the network segment of client or on other service addresses.

Run the following commands in global configuration mode.

Command	Purpose
macffvlan <i>vlan_id</i> other_ar <i>A.B.C.D</i>	Configures other ARs of MACFF in VLAN.
no macffvlan <i>vlan_id</i> other_ar <i>A.B.C.D</i>	Deletes other ARs of MACFF in VLAN.

36.1.1.5 Specifying a Physical Port to Shut down MACFF

If you specify a physical port to close MACFF, packets on this port will not be isolated and ARP packets will

not be listened.

Run the following commands in physical interface configuration mode.

Command	Operation
macff disable	Specifies a physical port to shut down MACFF.
no macff disable	Specifies a physical port to enable MACFF (it is enabled by default).

In default settings, the ports are allowed to enable MACFF.

36.1.1.6 Opening MACFF Debugging

Run the following commands in global configuration mode.

Command	Operation
debug macff	Opens MACFF debugging.
no debug macff	Closes MACFF debugging.

36.1.1.7 MACFF Configuration Example

The network topology is shown in figure 1.

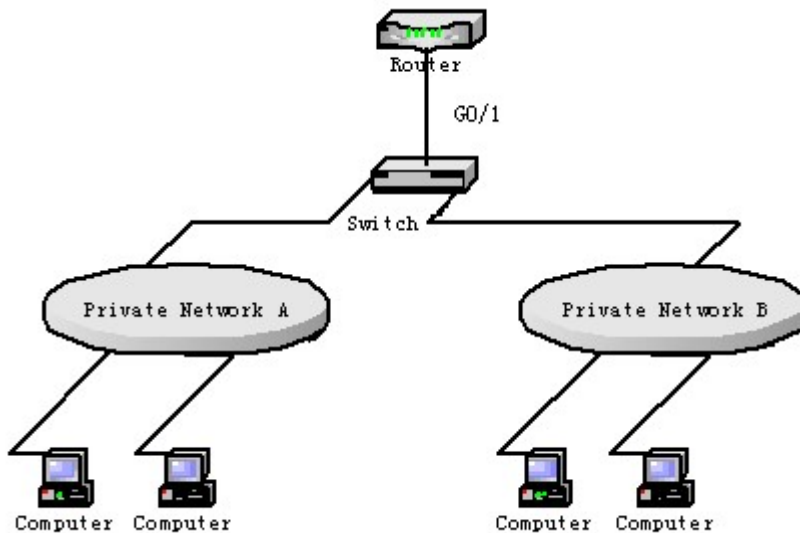

Switch configuration:

(1) Enable MACFF in VLAN1, which connects private network A. The default gateway allocated by DHCP server is 192.168.2.1.

```
Switch_config#arp 192.168.2.1 a8: f7: e0: 17: 92: ed
```

```
Switch_config#ip dhcp-relay snooping
```

```
Switch_config#ip dhcp-relay snooping vlan 1
```

```
Switch_config#macff enable
```

```
Switch_config#macff vlan 1 enable
```

- (2) Enable MACFF in VLAN2, which connects private network B. The default gateway allocated by DHCP server is 192.168.2.2 (If necessary, the default gateway can also be 192.168.2.1).

```
Switch_config#arp 192.168.2.2 a8: f7: e0: ea: 74: ee
```

```
Switch_config#ip dhcp-relay snooping vlan 2
```

```
Switch_config#macff vlan 2 enable
```

- (3) Sets the ports that connect DHCP server, default gateway and other ARs respectively to be trusted.

```
Switch_config_g0/1#dhcp snooping trust
```

- (4) If the downlink host A of VLAN 1 is manually configured IP and default gateway, the IP address is 192.168.2.102 and the MAC address is a8-f7-e0-59-18-b7. The default gateway, 192.168.2.1, enables MACFF to take effect. (If the client is not configured manually, this step will not be performed))

```
Switch_config#arp 192.168.2.1 a8: f7: e0: 17: 92: ed
```

```
Switch_config_g0/1#ip source binding a8-f7-e0-59-18-b7 192.168.2.102 interface GigaEthernet0/1
```

```
Switch_config_g0/1#macff vlan 1 default-ar 192.168.2.1
```

- (5) Specify a physical port in MACFF-enabled VLAN to shut down MACFF.

```
Switch_config_g0/1#macff disable
```

- (6) Configures other ARs that are in the same network segment of client. MACFF allows the client to perform direct access without the help of gateway. (the ports where other APs are should be set to trusted ports)

```
Switch_config_g0/1#macff disable
```

Chapter 37. IEEE 1588 Transparent Clock Configuration

37.1 Task List for IEEE1588 Transparent Clock Configuration

- Enabling the Transparent Clock
- Creating the Transparent Clock Port
- Configuring the Link Delay Calculation Mode
- Configuring the Forwarding Mode of Sync Packets
- Configuring the Domain Filtration Function
- Setting the Transmission Interval of Pdelay_Req Packets

37.2 Tasks for IEEE1588 Transparent Clock Configuration

37.3 Enabling the Transparent Clock

The IEEE1588 transparent clock is an intermediate device to connect the master and slave clocks. The IEEE1588 transparent clock can effectively reduce time synchronization interference caused by switch's delay processing and ensure ns-level time synchronization by verifying the dwell time when sync packets pass through the transparent clock.

In global configuration mode, run the following command to enable the transparent clock:

Command	Purpose
ptp enable	Enables the PTP transparent clock.

In global configuration mode, run the following command to shut down the transparent clock and delete all already added PTP ports:

Command	Purpose
noptp enable	Closes the PTP transparent clock.

The IEEE1588 clock synchronization protocol is independent from the underneath level protocols. It is based on either Ethernet or IPv4/UDP. To enable the transparent clock to transmit and receive IPv4- or UDP-based packets, you have to enable PTP in L3 port mode.

Run the following command in L3 port mode to enable PTP:

Command	Purpose
ptp enable	Enables the PTP transparent clock.

37.3.1 Creating the Transparent Clock Port

The transparent clock can include multiple PTP ports to connect the master and slave clock respectively. Run the following commands in port configuration mode to create the PTP ports:

Command	Purpose
ptp start I2	Creates the PTP L2 port.
Ptp start I3	Creates the PTP L3 port.

Run the following command in port configuration mode to delete the PTP ports:

Command	Purpose
no ptp start	Delete the PTP port.

37.3.2 Configuring the Link Delay Calculation Mode

The PTP transparent clock supports two link delay modes (E2E and P2P) to help the master and slave clocks switch between the two modes, among which P2P is the default mode. In E2E mode, TC can process **Delay_Req, Delay_Resp** packets; In P2P mode, the path-delay mechanism is running on each PTP port, the **Pdelay_Req** packets are transmitted periodically, and the **Pdelay_Resp** and **Pdelay_Resp_Follow_Up** packets are responded to. The two modes are incompatible with each other. For example, if it is in P2P mode, the **Delay_Req** packets received from the clock will be dropped.

Run the following command in global configuration mode to configure an authentication mode:

Command	Purpose
ptp delay-mechanism e2e	Sets TC to work in E2E mode.

To configure the authentication mode, you also can run the following command in interface configuration mode:

Command	Purpose
ptp delay-mechanism p2p	Sets TC to work in P2P mode.

37.3.3 Configuring the Forwarding Mode of Sync Packets

There are two ways to forward Sync packets: straight forwarding and store-forward.

In straight forwarding mode, the PTP port immediately forwards after receiving Sync packets, re-encapsulates the Follow_UP packets after receiving them and then forwards them out from the corresponding port.

In store-forward mode, the PTP port shall not forward Sync packets after receiving them but store them first, receive corresponding Follow_up packets and then forward the two kinds of packets together.

The straight forwarding mode is the default one. In this mode, the time to handle Sync packets is apparently less than the time to handle Follow_up packets and hence in case of multi-level TC cascading the risk of packet disorder arises. That's why the store-forward mode is recommended in case of multi-level TC cascading. However, in normal cases, we recommend the straight forwarding mode for it can lessen the residence time of Sync packets at the maximum level and reduce its impact on time synchronization.

Run the following command in global configuration mode to configure an authentication mode:

Command	Purpose
ptp sync-mechanism store-forward	Sets the forwarding method of Sync packets to store-forward .

To switch the forwarding mode over to straight forwarding, run the following command in global configuration mode:

Command	Purpose
ptp sync-mechanism straight-forward	Sets the forwarding method of Sync packets to store-forward .

37.3.4 Configuring the Domain Filtration Function

PTP devices can be classified through their domains for only PTP clocks in the same domain can exchange PTP synchronization packets and PTP devices in different domains cannot conduct time synchronization. After the domain filtration function is enabled, the PTP packets in other domains are dropped; if domain filtration is disabled, TC will not conduct the domain checkup.

Before domain filtration, you have to set the domain in which the PTP port is located. Run the following command in port mode:

Command	Purpose
ptp domain <i>number</i>	Sets the domain to which the PTP port belongs. The default domain of this port is domain0.

To configure the authentication mode, you also can run the following command in interface configuration mode:

Command	Purpose
ptp domain-filter	Enables domain filtration, which is enabled by default.

Run the following command in global mode to shut down domain filtration:

Command	Purpose
no ptp domain-filter	Closes domain filtration.

37.3.5 Setting the Transmission Interval of Pdelay_Req Packets

During the path-delay process, you can set the transmission interval of Pdelay_Req packets.

Run the following command to configure the transmission frequency.

Command	Purpose
ptp pdelay-interval <i>time</i>	time stands for the transmission interval, which ranges from -4 to 4. The actual transmission interval is <i>time</i> powers of 2. For example, if time is 0, the actual

	transmission interval is 1 second.
--	------------------------------------

37.4 PTP TC Configuration Example

See the following figure:

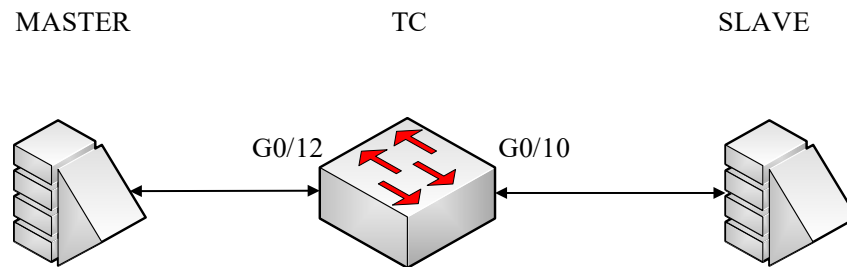

MASTER here stands for the master clock, which is a L2 PTP device. **SLAVE** here stands for the slave clock, which is a L3 PTP device. TC stands for a switch that supports transparent clock. The master clock connects port g0/12 of the switch, while the slave clock connects port g0/10 of the switch. MASTER, TC and SLAVE are all working in P2P mode. Ports g0/10 and G0/12 belong to VLAN1.

Global configuration

```
ptp enable
ptp delay-mechanism p2p
```

Configuration of L3 port

```
Ip add 192.168.0.2 255.0.0.0
ptp enable
```

Configuration of port g0/10

```
ptp start l2
```

Configuration of port g0/12

```
ptp start l3
```

Chapter 38. Layer 2 Tunnel Protocol Configuration

38.1 Configuring Layer-2 Protocol Tunnel

38.1.1 Introduction

Layer-2 protocol tunnel allows users between two sides of the switch to transmit the specified layer 2 protocol on their own network without being influenced by the relevant layer 2 software module of the switch. The switch is a transparent media for users.

38.1.2 Configuring Layer-2 Protocol Tunnel

Use the command line on the interface of the switch to configure tunnel function of the layer 2 protocol. The configuration steps are as follows:

Command	Description
configure	Enters global configuration mode.
interface <intf_name>	Enters interface configuration mode of the switch. Only the switch port supports layer 2 protocol tunnel (including physical port and aggregation port).
[no] l2protocol-tunnel [stp]	Enables layer 2 protocol of the tunnel function. Currently we only support tunnel function of stp protocol.
[CTRL] + Z	Returns to EXEC mode.
write	Saves configuration.

38.1.3 Configuration Example of Layer 2 Protocol Tunnel

Network environment is as follows:

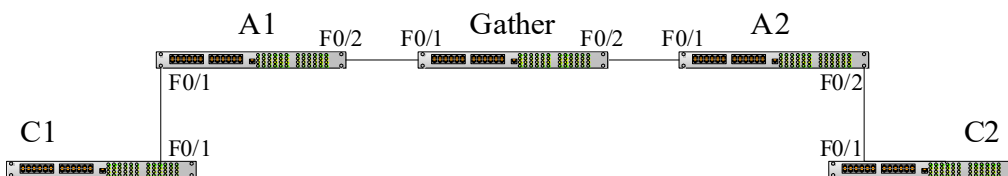

A1/A2/Gather belong to core network, C1/C2 are switches distributed in two places. Customer wants to combine two of its network to one, that is, the core network is a transparent transmission channel for the customer. If user wants to realize the transparent transmission of STP, then the following configurations should be configured on each switch:

- (1) The f0/2 of Switch A1, f0/1 and f0/2 of Gather, f0/1 of A2 should be configured to trunk mode.
- (2) The f0/1 of switch A1, f0/2 of A2 should be configured to Access, and enables tunnel function of the STP protocol.

Chapter 39. Loopback Detection Configuration

39.1 Setting Loopback Detection

39.1.1 Introduction of Loopback Detection

The loopback in a network may trigger the repeated transmission of broadcast, multicast or unicast packets, wasting network resources and even leaving network breakdown. To avoid the above-mentioned troubles, it is necessary to provide a detection mechanism to promptly notify users of detecting network connection and configuration at the occurrence of loopback and to take troubled ports under control. Loopback detection can check whether loopback happens on a port of a to-be-tested device by transmitting a detection packet from this port and checking whether this packet can be received still on this port. When the device finds that loopback exists on its port, it can transmit alarm promptly to the network management system for administrators to detect network problems in time; thus, long time of network disconnection can be prevented. Moreover, loopback detection is capable of having ports under control. You can opt for port block, port MAC-learning forbidding or error-disable according to actual requirements to make corresponding ports under control and lessen the loopback's network influence to the minimum level.

The managed switches support loopback detection in the following aspects:

- Supporting to set loopback detection on the port
- Supporting to set the destination MAC address for loopback detection packets
- Supporting to conduct loopback detection to at most 10 specified ports
- Supporting to set the transmission interval of loopback detection packets and the recovery time of controlled port
- Supporting to control port, including port block, port MAC-learn forbidding, and error-disable
- Supporting to set whether loopback exists on a port by default

39.1.1.1 Format of Loopback Detection Packet

Field	Length/Byte	Value
DMAC	6	0x0180C2B0000A (default value, configurable)
SMAC	6	MAC address of the switch
TPID	2	0x8100, VLAN tag type
TCI	2	Specific value of the VLAN tag, priority, VLAN ID
TYPE	2	Protocol type, which ranges from 0 to 9001
CODE	2	Protocol sub-type, which represents loopback detection and is 0x0001
VERSION	2	0x0000 (currently reserved)

Length	2	0x0008, length of the header of loopback detection packet
RESERVE	2	Reserved field
SYSMAC	6	MAC address of the switch
SEQUENCE	4	Sequence ID of packet, which is generated randomly by the system before the packet is transmitted
DiID	4	Port ID, which is the ID of the global port of 85 Series
End	2	0x0000, end character

39.1.2 Loopback Detection Configuration Tasks

- Configuring Loopback Detection Globally
- Configuring Port Loopback Detection
- Setting a Port to Perform Loopback Detection toward Specified VLAN
- Configuring the Loopback Detection Interval on a Port
- Setting a Port under Control
- Setting Loopback to Exist on a Port by Default
- Displaying the Configuration of Global Loopback Detection
- Displaying the Information about the Loopback Detection Port

39.1.3 Setting Loopback Detection

39.1.3.1 Configuring Loopback Detection Globally

Enabling or disabling loopback detection globally means enabling or disabling loopback detection on all physical ports. Global configuration is just like a switch. Only when this switch is opened can enabled loopback detection on a port take effect.

Command	Purpose
[no] loopback-detection	Sets loopback detection globally.

39.1.3.2 Configuring Port Loop Check

If you want to enable or disable loopback detection on a specified port, you should first enable loopback detection globally.

Command	Purpose
[no] loopback-detection enable	Configures port loopback detection.

39.1.3.3 Configuring a Port to Conduct Loopback Detection in Specified VLAN

If you set loopback detection in a specified VLAN, a port shall transmit multiple detection packets with specified VLAN tag regularly and the port can transmit up to 10 detection packets with specified VLAN tag.

One point to be noted is that the port must exist in the specified VLAN, or the configuration takes no effect. If loopback detection happens in VLAN2 to VLAN8, ports are configured to be in trunk mode, and trunk vlan-allowed is vlans 5-8, the packets with tags 2-4 transmitted by the switch cannot pass through this port and the configuration hence takes no effect.

Command	Purpose
[no] loopback-detection vlan-control <i>vlanlist</i>	Configures a port to conduct loopback detection in specified VLAN.

39.1.3.4 Configuring the Loopback Detection Interval of Port (Packet transmission interval, controlled port recovery time)

Command	Purpose
[no] loopback-detection hello-time <i>time</i>	Configures the transmission interval of port loopback detection packets.

Because a network is always changeable, loopback detection is a continuous process. The port will transmit loopback detection packets in a regular time. This regular time is called as the transmission interval of loopback detection packets. The default transmission interval of the system is 3 seconds.

Command	Purpose
[no] loopback-detection recovery-time <i>time</i>	Configures the transmission interval of port loopback detection packets.

This command above is used to set the automatic recovery time of a port when loopback disappears. In default settings, if a port has not received the already transmitted loopback detection packet within 10 seconds, it is regarded that loopback vanishes. It is recommended to set the recovery time to be triple of the packet transmission time; if the transmission time is set to be a very small value, you'd better set the recovery time to be at least 10 seconds longer than the transmission time.

39.1.3.5 Configuring Port Control

Command	Purpose
[no] loopback-detection control {block learning shutdown}	Configures port control.

When a port detects that loopback exists in its network, you can set port control to manage this port. The control state of a port can be **block**, **nolearn**, **shutdown** or **trap**. When any control state is set and loopback exists on a port, the trap alarm message will be transmitted. It is not configured by default.

When loopback detection is enabled globally, a loopback detection packet is transmitted from a port, on which loopback detection is enabled, and received again by this port, the port may get the following four control actions:

Block: When loopback is found, this port is then isolated from other ports. Hence the packets entering this port cannot be forwarded to other ports. The port is then in protocol down state and its MAC address table list ages.

Nolearn: means to forbid the port to learn MAC addresses. When loopback is detected, the port will not

conduct MAC address learning any more and at the same time the MAC address table of this port ages.

shutdown: Means to close the port. When loopback is detected, except that trap message will be transmitted and the port's MAC address table ages, the port will be automatically closed and it cannot forward packets any more until the err-disable-recover time.

Trap: It means that the port only reports alarm. When loopback is detected, the port only reports alarm and ages its MAC address table without any further action.

When the port is in block state, it cannot forward incoming packets and at the same time it transmits loopback detection packets continuously. When loopback disappears, the port will recover automatically. In default settings, if a port has not received the already transmitted loopback detection packet within 10 seconds, it is regarded that loopback vanishes.

In block state, the port protocol is down; in shutdown state, the port's link is down directly.

39.1.3.6 Configuring the Destination MAC Address of Loopback Detection Packet

Command	Purpose
[no] loopback-detection dest-mac <i>Mac-address</i>	Configures the destination MAC address of loopback detection packet.

The default destination MAC address of loopback detection packet is **01-80-C2-00-00-0a**. If you have set other destination MAC, it will be used as the destination MAC address of loopback detection packet.

39.1.3.7 Configuring Loopback to Exist on a Port by Default

Command	Purpose
[no] loopback-detection existence	Configures loopback to exist on a port by default.

When a port is up and port loopback detection takes effect, the command above is used to set whether loopback exists on this port. When a port is in shutdown state, this port is not suitable to set to have loopback, for the port in shutdown state cannot forward packets. The default settings is that loopback does not exist in a port.

39.1.3.8 Displaying the Configuration of Global Loopback Detection

Command	Purpose
show loopback-detection	Displays the configuration of global loopback detection.

This command is used to display the information about global loopback detection configuration, including global configuration, whether loopback exists on each port, and some ports' configurations.

39.1.3.9 Displaying the Configuration of Port Loopback Detection

Command	Purpose
show loopback-detection interface <i>intf</i>	Displays the configuration of port loopback detection.

This command is mainly used to display port loopback detection, including the port timer and the information about transmitted and received packets.

39.1.4 Configuration Example

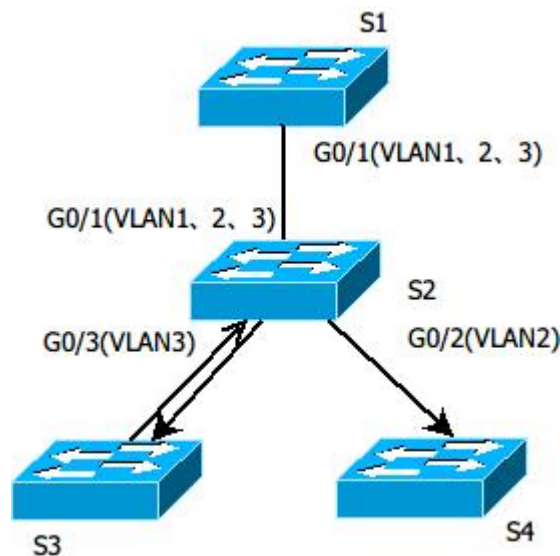

Figure 1.1 Loopback detection configuration

As shown in figure 1.1, the port of S1 conducts loopback detection to specified VLANs 1, 2 and 3. The corresponding configurations on all switches are shown below:

Switch S1:

Configuration of interface GigaEthernet0/1:

```
switchport trunk vlan-untagged 1-3
```

```
switchport mode trunk
```

```
loopback-detection enable
```

```
loopback-detection control block
```

```
loopback-detection vlan-control 1-5
```

Global Configuration

```
loopback-detection
```

```
vlan 1-3
```

Switch S2:

Configuration of interface GigaEthernet0/1:

switchport mode trunk

Configuration of interface GigaEthernet0/2:

switchport mode trunk

Configuration of interface GigaEthernet0/3:

switchport mode trunk

Global Configuration

vlan1-3

Switch S3:

Configuration of interface GigaEthernet0/1:

switchport pvid 3

If loopback exists in the network that S3 connects and the PVID of the interface, on which loopback exists, is 3, the packets will be transmitted to interface g0/1 of S1 and S1 will block interface g0/1 after finding loopback.

Chapter 40. QoS Configuration

If you care to use your bandwidth and your network resources efficiently, you must pay attention to QoS configuration.

40.1 QoS Configuration

40.1.1 QoS Overview

40.1.1.1 40.1.1.1 QoS Concept

In general, the switch works in best-effort served mode in which the switch treats all flows equally and tries its best to deliver all flows. Thus if congestion occurs all flows have the same chance to be discarded. However in a real network different flows have different significances, and the QoS function of the switch can provide different services to different flows based on their own significances, in which the important flows will receive a better service.

As to classify the importance of flows, there are two main ways on the current network:

- The tag in the 802.1Q frame header has two bytes and 3 bits are used to present the priority of the packet. There are 8 priorities, among which 0 means the lowest priority and 7 means the highest priority.
- The DSCP field in IP header of the IP packet uses the bottom 6 bits in the TOS domain of the IP header.

In real network application the edge switch distributes different priorities to different flows based on their significance and then different services will be provided to different flows based on their priorities, which is the way to realize the terminal-to-terminal QoS.

Additionally, you can also configure a switch in a network, enabling the switch to process those packets with specific attributes (according to the MAC layer or the L3 information of packets) specially. This kind of behaviors are called as the one-leap behaviors.

The QoS function of the switch optimizes the usage of limited network bandwidth so that the entire performance of the network is greatly improved.

40.1.1.2 Terminal-To-Terminal QoS Model

The service model describes a group of terminal-to-terminal QoS abilities, that is, the abilities for a network to transmit specific network communication services from one terminal to another terminal. The QoS software supports two kinds of service models: Best-Effort service and Differentiated service.

1. Best-effort service

The best-effort service is a singular service model. In this service model, an application can send any amount of data at any necessary time without application of permits or network notification. As to the best-effort service, if allowed, the network can transmit data without any guarantee of reliability, delay or throughput. The QoS of the switch on which the best-effort service is realized is in nature this kind of service, that is, first come

and first served (FCFS).

2. Differentiated service

As to the differentiated service, if a special service is to be transmitted in a network, each packet should be specified with a corresponding QoS tag. The switch uses this QoS rule to conduct classification and complete the intelligent queuing. The QoS of the switch provides Strict Priority (SP), Weighted Round Robin (WRR), Deficit Round Robin (DRR) and First-Come-First-Served (FCFS).

40.1.1.3 Queue Algorithm of QoS

Each queue algorithm is the important basis to realize QoS. The QoS of the switch provides the following algorithms: Strict Priority (SP), Weighted Round Robin (WRR), Deficit Round Robin (DRR) and First-Come-First-Served (FCFS).

1. Strict priority

This algorithm means to first provide service to the flow with the highest priority and after the highest-priority flow comes the service for the next-to-highest flow. This algorithm provides a comparatively good service to those flows with relatively high priority, but its shortage is also explicit that the flows with low priority cannot get service and wait to die.

2. Weighted round robin

Weighted Round Robin (WRR) is an effective solution to the defect of Strict Priority (SP), in which the low-priority queues always die out. WRR is an algorithm that brings each priority queue a certain bandwidth and provides service to each priority queue according to the order from high priority to low priority. After the queue with highest priority has used up all its bandwidth, the system automatically provides service to those queues with next highest priority.

3. Weighted Fair Queuing

Weighted Round Robin (WRR) is an effective solution to the defect of Strict Priority (SP), in which the low-priority queues always die out. WRR is an algorithm that brings each priority queue a certain bandwidth and provides service to each priority queue according to the order from high priority to low priority. After the queue with highest priority has used up all its bandwidth, the system automatically provides service to those queues with next highest priority.

4. First come first served

The First-Come-First-Served queue algorithm, which is shortened as FCFS, provides service to those packets according to their sequence of arriving at a switch, and the packet that first arrives at the switch will be served first.

40.1.1.4 Weighted Random Early Detection

Congestion avoidance and traditional packet loss mechanism

Excessive congestion may inflict damage on network resources, so network congestion should be resolved through some measures. Congestion avoidance is a sort of flow control method of positively dropping packets and regulating network flows to solve network overload via network resource monitoring. The traditional way of resolving network congestion is to drop all incoming packets when the queue length reaches its threshold. But for TCP packets, heavy packet loss may cause TCP timeout and lead to slow TCP startup and congestion avoidance, which is called as TCP global synchronization.

WRED

The WRED algorithm is adopted to prevent TCP global synchronization. WRED helps users to set the queue threshold. When the queue length is less than the configured threshold, the packets will not be dropped; otherwise, the packets will be dropped randomly. Because WRED drops packets randomly, it is avoided for multiple TCP connections to slow down the transmission speed at the same time, which is the reason why TCP global synchronization is avoided. WRED enables other TCP connections to maintain a relatively high transmission speed when the packets of a certain TCP connection begin to be dropped and their transmission speed is slowed down. No matter what time it is, there are always some TCP connections to transmit packets with a high speed, which ensures effective bandwidth usability.

WRED cooperation is conducted when packets enter the outgoing queue and are checked for their size and packets in different ranges get different treatments. The key parameters include **Start**, **Slop** and **Drop priority**.

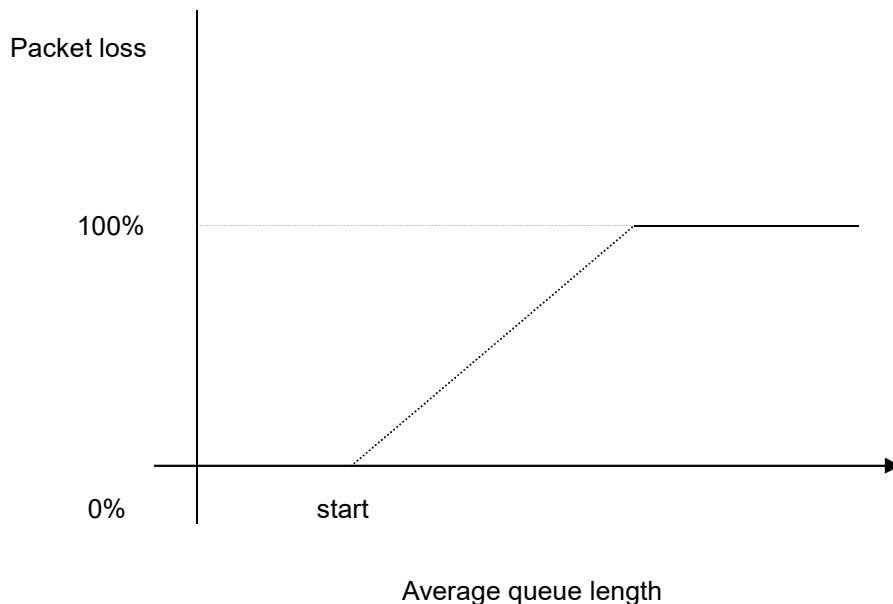

- When the queue length is less than start, packets will not be dropped.
- When the queue length is bigger than start, the incoming packets begin to be dropped randomly. The longer the queue is, the higher the dropping rate is.
- The rate for packet loss rises along with the increase of the queue length.

40.1.2 QoS Configuration Task List

In general, ONU will try its best to deliver each packet and when congestion occurs all packets have the same chance to be discarded. However, in reality different packets have different importance and the comparatively important packets should get the comparatively good service. QoS is a mechanism to provide different priority services to packets with different importance, in which the network can have its better performance and be used efficiently.

This chapter presents how to set QoS on ONU.

The following are QoS configuration tasks:

- Setting the Global CoS Priority Queue
- Setting the Bandwidth of the CoS Priority Queue
- Setting the Schedule Policy of the CoS Priority Queue
- Setting the Default CoS Value of a Port
- Setting the CoS Priority Queue of a Port
- Setting the CoS Priority Queue of a Port
- Establishing the QoS Policy Mapping
- Setting the Description of the QoS Policy Mapping
- Setting the Matchup Data Flow of the QoS Policy Mapping
- Setting the Actions of the Matchup Data Flow of the QoS Policy Mapping
- Applying the QoS Policy on a Port
- Displaying the QoS Policy Mapping Table

40.1.3 QoS Configuration Tasks

40.1.3.1 Setting the Global CoS Priority Queue

The task to set the QoS priority queue is to map 8 CoS values, which are defined by IEEE802.1p, to the priority queues in a switch. This series of switch has 8 priority queues. According to different queues, the switch will take different schedule policies to realize QoS.

If a CoS priority queue is set in global mode, the mapping of CoS priority queue on all ports will be affected.

When priority queues are set on a L2 port, the priority queues can only work on this L2 port.

Enter the following privileged mode and run the following commands one by one to set DSCP mapping.

Command	Purpose
config	Enters the global configuration mode.
[no] cos map <i>quid cos1..cosn</i>	Sets the CoS priority queue. quid stands for the ID of a CoS priority queue. cos1...cosn stands for the IEEE802.1p-defined CoS value.
exit	Goes back to the EXEC mode.
write	Saves the settings.

40.1.3.2 Setting the Bandwidth of the CoS Priority Queue

The bandwidth of priority queue means the bandwidth distribution ratio of each priority queue, which is set when the schedule policy of the CoS priority queue is set to WRR/DRR. This series of switches has 8 priority queues in total.

If this command is run, the bandwidth of all priority queues on all interfaces are affected. This command validates only when the queue schedule policy is set to WRR or DRR. This command decides the bandwidth weight of the CoS priority queue when the WRR/DRR schedule policy is used.

Run the following commands one by one to set the bandwidth of the CoS priority queue.

Command	Purpose
config	Enters the global configuration mode.
[no] scheduler weight bandwidth <i>weight1...weightn</i>	Sets the bandwidth of the CoS priority queue.. weight1...weightn stand for the weights of 8 CoS priority queues of WRR/DRR.
exit	Goes back to the EXEC mode.
write	Saves the settings.

40.1.3.3 Setting the Schedule Policy of the CoS Priority Queue

A switch has many output queues on each of its port. This series of switches has 8 priority queues. The output queues can adopt the following three schedule modes:

- SP (Sheer Priority): In this algorithm, only when the high-priority queue is null can the packets in the low-priority queue be forwarded, and if there are packets in the high-priority queue these packets will be unconditionally forwarded.
- In this mode, the bandwidth of each queue is distributed with a certain weight and then bandwidth distribution is conducted according to the weight of each queue. The bandwidth in this mode takes byte as its unit.
- The First-Come-First-Served queue algorithm, which is shortened as FCFS, provides service to those packets according to their sequence of arriving at a switch, and the packet that first arrives at the switch will be served first.

Enter the following configuration mode and set the schedule policy of CoS priority queue.

Command	Purpose
config	Enters the global configuration mode.
[no] scheduler policy { sp wrr wfq fcfs }	Sets the schedule policy of the CoS priority queue. sp means to use the SP schedule policy. Wrr means to use the WRR schedule policy. Fcfs to use the FCFS schedule policy. dr means to use the DRR schedule policy.
exit	Goes back to the EXEC mode.
write	Saves the settings.

40.1.3.4 Configuring the Minimum and Maximum Bandwidths of CoS Priority Queue

The minimum and maximum bandwidths of CoS priority queue can be modified through configuration. All the flows with a bandwidth less than the configured minimum bandwidth shall not be dropped, but the flows with a bandwidth bigger than the configured maximum bandwidth shall all be dropped.

Enter the privileged mode.

Command	Purpose
config	Enters the global configuration mode.
interface g0/1	Enters the to-be-configured port.
[no] cos bandwidth quid <i>min-bandwidth max-bandwidth</i>	quid stands for the priority queue. min-bandwidth means the minimum bandwidth. max-bandwidth means the maximum bandwidth.
exit	Goes back to the global configuration mode.
exit	Goes back to the EXEC mode.
write	Saves the settings.

40.1.3.5 Configuring Weighted Random Early Detection

Enters the privileged mode.

Command	Purpose
config	Enters the global configuration mode.
scheduler wred [queue quid {drop-level drop-level low-limit <i>limit-percent slope slope}]</i> no scheduler wred [queue quid]	Sets WRED. quid stands for the queue. drop-level stands for the packet dropping level. limit-percent stands for the starting percent. Slop stands for the packet dropping trend.
exit	Goes back to the EXEC mode.
write	Saves the settings.

40.1.3.6 Setting the Default CoS Value of a Port

If the port of a switch receives a data frame without tag, the switch will add a default CoS priority to it. Setting the default CoS value of a port is to set the untagged default CoS value, which is received by the port, to a designated value.

Enter the privilege mode and run the following commands to set the default CoS value of a port:

Command	Purpose
config	Enters the global configuration mode.

interface g0/1	Enters the to-be-configured port.
[no] cos default cos	Sets the CoS value of the received untagged frames. cos stands for the corresponding CoS value.
exit	Goes back to the global configuration mode.
exit	Goes back to the EXEC mode.
write	Saves the settings.

40.1.3.7 Setting the CoS Priority Queue of a Port

When a priority queue is set on a L2 port, the priority queue will be used by the L2 port; otherwise, you should conduct the configuration of a global CoS priority queue.

Enter the privilege mode and run the following commands to set the default CoS value of a port:

Command	Purpose
config	Enters the global configuration mode.
interface g0/1	Enters the to-be-configured port.
[no] cos map quid cos1..cosn	Sets the CoS priority queue. quid stands for the ID of a CoS priority queue. cos1...cosn stands for the IEEE802.1p-defined CoS value.
exit	Goes back to the global configuration mode.
exit	Goes back to the EXEC mode.

40.1.3.8 Setting the CoS Priority Queue of a Port

Based on the DSCP value, the COS queue is mapped again, the DSCP value is modified and the congestion bit is changed.

Enter the privilege mode and run the following commands to set the default CoS value of a port:

Command	Purpose
config	Enters the global configuration mode.
[no]dscp map word {dscpdscp-value coscos-value cngcng-bit }	word stands for the DSCP range table. dscp-value means to set the mapped DSCP value. cos-value means to set the mapped priority CoS. Cng-bit means the mapped congestion bit.
exit	Goes back to the global configuration mode.
exit	Goes back to the EXEC mode.

40.1.3.9 Establishing the QoS Policy Mapping

Flow classification means to identify a class of packets with certain attributes by applying a certain regulation and take designated actions towards to these packets.

Enter the privileged mode and then run the following commands to establish a new QoS policy mapping.

Command	Purpose
config	Enters the global configuration mode.
[no]policy-map <i>name</i>	Enters the configuration mode of the QoS policy map. name stands for the name of the policy.
exit	Exits from the global configuration mode.
exit	Goes back to the EXEC mode.

40.1.3.10 Setting the Description of the QoS Policy Mapping

Enter the privileged mode and run the following commands to set the description of a QoS policy mapping.

This setting will replace the previous settings.

Command	Purpose
config	Enters the global configuration mode.
[no]policy-map <i>name</i>	Enters the configuration mode of the QoS policy map. name stands for the name of the policy.
description <i>description-text</i>	Sets the description of the QoS policy. description-text stands for the text to describe the policy.
exit	Goes back to the global configuration mode.
exit	Goes back to the EXEC mode.

40.1.3.11 Setting the Matchup Data Flow of the QoS Policy Mapping

The classification rule of the QoS data flow means the filtration rule configured by the administrator according to management requirements. It can be simple, for example, flows with different priorities can be identified by the ToS field of the IP packet's header, or complicated, for example, the packets can be classified according to the related information about the comprehensive link layer, the network layer and the transmission layer, such as the MAC address, the source address of IP, the destination address or the port ID of the application. In general, the classification standard is limited in the header of an encapsulated packet. It is rare to use the content of a packet as the classification standard.

Enter the policy configuration mode, set the match-up data flow of policy and replace the previous settings with this data flow according to the following steps:

Command	Purpose
config	Enters the global configuration mode.

[no]policy-map name	Enters the configuration mode of the QoS policy map. name stands for the name of the policy.
description description-text	Sets the description of the QoS policy. description-text stands for the text to describe the policy.
classify { any cos cos icos icos vlan vlanid ivlan ivlanid ethernet-type ethernet-type precedence precedence-value dscp dscp-value tos tos-value diffserv diffserv-value ip ip-access-list ipv6 ipv6-access-list mac mac-access-list } no classify { cos icos vlan ivlan ethernet-type precedence dscp tos diffserv ip ipv6 mac }	Matches up with any packet. Configures the matched COS value which ranges between 0 and 7. icos stands for the matched inner COS value which ranges between 0 and 7. vlanid stands for the matched VLAN, which ranges from 1 to 4094. ivlanid stands for the matched inner VLAN, which ranges from 1 to 4094. ethernet-type stands for the matched packet type, which is between 0x0600 and 0xFFFF. precedence-value stands for the priority field in tos of IP packet, which ranges from 0 to 7. dscp-value stands for the dscp field in tos of IP packet, which ranges from 0 to 63. tos-value stands for latency, throughput, reliability and cost fields in tos of IP packet, which ranges from 0 to 15. diffserv-value stands for the entire tos field. ip-access-list stands for the name of the matched IP access list. The name has 1 to 20 characters. ipv6-access-list stands for the name of the matched IPv6 access list. The name has 1 to 20 characters. Configures the name of the matched MAC access list. The name has 1 to -20 characters.
exit	Goes back to the global configuration mode.
exit	Goes back to the EXEC mode.

40.1.3.12 Setting the Actions of the Match-up Data Flow of the QoS Policy Mapping

The actions to define the data flow mean to take corresponding actions to a data flow with compliance of the filtration rule, which include bandwidth limit, drop, update, etc.

Enter the privileged mode and run the following commands to set the action of a policy, matching up the data flow. The action will replace the previous settings.

Command	Purpose
config	Enters the global configuration mode.
[no]policy-map name	Enters the configuration mode of the QoS policy map. name stands for the name of the policy.
action { bandwidth max-band { cir commit-band { bc commit-burst-size { be peak-burst-size pir pir-band }} [conform { forward dscpdscp-value } exceed { forward drop dscp dscp-value discardable { green yellow red }} violate { forward drop dscp dscp-value discardable { green yellow red }}}] cos cos drop dscp dscp-value precedence precedence-value forward icos icos ivlan { add ivlanid del ivlanid ivlanid } cpicos mac mac-addr monitor session-value queue queue-value redirect interface-id stat-packet stat-byte vlanID { add vlanid vlanid }}	<p>max-band stands for the occupied maximum bandwidth.</p> <p>Sets the policing:</p> <p>cir commit-band stands for the certified bandwidth.</p> <p>bc commit-burst-size stands for the size of burst packet, which ranges from 4 to 4096Kb.</p> <p>be peak-burst-size stands for the size of peak burst, which ranges from 4 to 4096Kb.</p> <p>pir pir-band stands for the peak bandwidth, which ranges from 1 to 163840.</p> <p>conform {forward dscp dscp-value} stands for a bandwidth guarantee action, among which forward means not to conduct any action and dscp means to change the dscp value.</p> <p>drop means to drop the matched packets.</p> <p>Sets the matched DSCP field to dscp-value 0~63.</p> <p>precedence-value stands for the priority field of tos in ip packet.0-7.</p> <p>Conducts no operations to the matched packets.</p> <p>Sets the matched COS field to cos-value 0-7.</p> <p>ivlanid is used to replace, add or delete the inner VLAN ID.</p> <p>cpicos means to replace the outer cos with inner cos.</p> <p>mac-addr is used to set the destination MAC address.</p> <p>session-value is used to set mirroring, which ranges from 1 to 4.</p> <p>queue-value is used to set the mapping</p>
no action { bandwidth cir cos drop dscp precedence forward icos ivlan cpicos mac monitor queue redirect stat-packet stat-byte vlanID }	

	<p>queue, which ranges from 1 to 8.</p> <p>Redirects the egress port of the matched flow.</p> <p>stat-packet stands for the number of packets under statistics.</p> <p>stat-byte means the number of bytes under statistics.</p> <p>vlanID is used to replace or add the outer vlan ID, which ranges from 1 to 4094.</p>
exit	Goes back to the global configuration mode.
exit	Goes back to the EXEC mode.

40.1.3.13 pplying the QoS Policy on a Port

The QoS policy can be applied to a port; multiple QoS policies can be applied to the same port and the same QoS policy can also be applied to multiple ports. On the same port, the priorities of the policies which are earlier applied than those of the policies which are later applied. If a packet is set to have two policies and the actions are contradicted, the actions of the firstly matched policies. After a QoS policy is applied on a port, the switch adds a policy to this port by default to block other data flows, which are not allowed to pass through. When all policies on a port are deleted, the switch will automatically remove the default blockage policy from a port.

Enter the following privileged mode and run the following commands to apply the QoS policy.

Command	Purpose
config	Enters the global configuration mode.
interface g0/1	Enters the to-be-configured port.
[no] qos policy name { ingress egress}	<p>Applies the QoS policy on a port.</p> <p>name stands for the name of QoS policy mapping.</p> <p>ingress means to exert an influence on the ingress.</p> <p>egress means to exert an influence on the egress.</p>
exit	Goes back to the global configuration mode.
exit	Goes back to the EXEC mode.

40.1.3.14 Displaying the QoS Policy Mapping Table

You can run the **show** command to display all or some designated QoS policy maps.

Run the following command in privileged mode to display the QoS policy mapping table.

Command	Purpose
show policy-map [policy-map-name]	<p>Displays all or some designated QoS policy maps.</p> <p>policy-map-name stands for the name of QoS mapping table.</p>

40.1.4 QoS Configuration Example

40.1.4.1 Example for Applying the QoS Policy on a Port

The following example shows how to set packet's cos to 2 on port g0/2:

```
ip access-list extended ipacl
permit ip 192.168.20.2 255.255.255.255 192.168.20.210 255.255.255.255
!
policy-map pmap
classify ip ipacl
action cos 2
!
interface g0/2
qos policy pmap ingress
!
```

Chapter 41. DoS Attack Prevention Configuration

41.1 DoS Attack Prevention Configuration

41.1.1 DoS Attack Overview

41.1.1.1 Concept of DoS Attack

The DoS attack is also called the service rejection attack. Common DoS attacks include network bandwidth attacks and connectivity attacks. DoS attack is a frequent network attack mode triggered by hackers. Its ultimate purpose is to break down networks to stop providing legal users with normal network services. DoS attack prevention requires a switch to provide many attack prevention methods to stop such attacks as Pingflood, SYNflood, Landattack, Teardrop, and illegal-flags-contained TCP. When a switch is under attack, it needs to judge which attack type it is and handles these attack packets specially, for example, sending them to CPU and drop them.

41.1.1.2 DoS Attack Type

Hackers will make different types of DoS attack packets to attack the servers. The following are common DoS attack packets:

41.1.1.3 Ping of Death

Ping of Death is the abnormal Ping packet, which claims its size exceeds the ICMP threshold and causes the breakdown of the TCP/IP stack and finally the breakdown of the receiving host.

41.1.1.4 TearDrop

TearDrop uses the information, which is contained in the packet header in the trusted IP fragment in the TCP/IP stack, to realize the attack. IP fragment contains the information that indicates which part of the original packet is contained, and some TCP/IP stacks will break down when they receive the fake fragment that contains the overlapping offset.

41.1.1.5 SYN Flood

A standard TCP connection needs to experience three hand-shake processes. A client sends the SYN message to a server, the server returns the SYN-ACK message, and the client sends the ACK message to the server after receiving the SYN-ACK message. In this way, a TCP connection is established. SYN flood triggers the DoS attack when the TCP protocol stack initializes the hand-shake procedure between two hosts.

41.1.1.6 Land Attack

The attacker makes a special SYN message (the source address and the destination address are the same

service address). The SYN message causes the server to send the SYN-ACK message to the sever itself, hence this address also sends the ACK message and creates a null link. Each of this kinds of links will keep until the timeout time, so the server will break down. Landattack can be classified into IPland and MACland.

41.1.2 DoS Attack Prevention Configuration Task List

As to global DoS attack prevention configuration, you configure related sub-functions and then the switch drops corresponding DoS attack packets. Hence, the bandwidth of the switch is guaranteed not to be used up.

DoS attack prevention configuration tasks are shown below:

Configuring Global DoS Attack Prevention

Displaying All DoS Attack Prevention Configuration

41.1.3 DoS Attack Prevention Configuration Tasks

41.1.3.1 Configuring Global DoS Attack Prevention

Configuring global DoS attack prevention means configuring DoS attack prevention sub-functions in global mode and each sub-function can prevent a different type of DoS attack packets. The DoS IP sub-function can prevent the LAND attacks, while the DoS ICMP sub-function can prevent Ping of Death. You can set the corresponding sub-function according to actual requirements.

Configure the DoS attack prevention function in EXEC mode.

Command	Purpose
config	Enters the global configuration mode.
[no] dos enable {all icmp icmp-value ip ipv4firstfrag l4port mac tcpflags tcpfrag tcpfrag-value}	<p>Configures all to prevent all types of DoS attack packets.</p> <p>Configures icmp to prevent the ICMP packets, among which the icmp-value means the maximum length of the ICMP packet.</p> <p>Configures ip to prevent those IP packets whose source IPs are the same as the destination IPs.</p> <p>Configures ipv4firstfrag to check the first fragment of the IP packet.</p> <p>Configures l4port to prevent those TCP/UDP packets whose source port IDs are destination port IDs.</p> <p>Configures mac to prevent those packets whose source MACs are destination MACs.</p> <p>Configures tcpflags to prevent those TCP packets containing illegal TCP flags.</p> <p>Configures tcpfrag to prevent those TCP packets whose minimum TCP header is tcpfrag-value.</p>
exit	Goes back to the EXEC mode.

write	Saves the settings.
--------------	---------------------

41.1.3.2 Displaying All DoS Attack Prevention Configurations

You can display the Dos attack prevention configurations through the **show** command.

Run the following command in EXEC mode to display the configured DoS attack prevention functions.

Command	Purpose
show dos	Displays Dos attack prevention configuration.

41.1.4 DoS Attack Prevention Configuration Example

The following example shows how to configure to prevent the attacks of TCP packets, which have illegal flags, and then displays user's configuration.

```
config
```

```
dos enable tcpflags
```

```
show dos
```

The following example shows how to prevent the attacks of IP packets whose source IPs are destination IPs in global mode.

```
config
```

```
dos enable ip
```

The following example shows how to prevent in global mode the attacks of ICMP packets whose maximum length is more than 255.

```
config
```

```
dos enable icmp 255
```

Chapter 42. Attack Prevention Configuration

42.1 Attack Prevention Configuration

42.1.1 Overview

To guarantee the reasonable usage of network bandwidth, our 6508 series switches provide the function to prevent vicious traffic from occupying lots of network bandwidth. In light of current attack modes, our 6508 series switches can limit the hosts that send lots of ARP, IGMP or IP message in a period of time and do not provide any service to these hosts. The function can prevent malicious message from occupying lots of network bandwidth. Therefore, the network can not be congested.

42.1.2 Attack Prevention Configuration Tasks

When the number of IGMP, ARP or IP message that is sent by a host in a designated interval exceeds the threshold, we think that the host attacks the network.

You can select the type of attack prevention (ARP, IGMP or IP), the attack prevention port and the attack detection parameter. You have the following configuration tasks:

- Configuring the attack prevention type
- Configuring the attack detection parameters

42.1.3 Attack Prevention Configuration

42.1.3.1 Configuring the Attack Detection Parameters

Command	Description
filter period <i>time</i>	Sets the attack detection period to time , whose unit is second.
filter threshold <i>value</i>	Sets the attack detection threshold to value . The parameter value represents the number of message at the threshold.
filter block-time <i>time</i>	Sets the out-of-service time for the attack source when the attack source is detected. Its unit is second.

42.1.3.2 Configuring the Attack Prevention Type

Command	Description
filter igmp	Detects the igmp attack.
filter ip source-ip	Detects the IP attack based on the source IP address.
interface f x/y	Enters interface configuration mode for interface y

	at slot X.
filter arp	Detects the arp attack.

The ARP attack takes the host's MAC address and the source port as the attack source, that is, message from the same MAC address but different ports cannot be calculated together. Both the IGMP attack and IP attack take the host's IP address and source port as the attack source.

Remember that the IGMP attack prevention and the IP attack prevention cannot be started up together.

42.1.3.3 Starting up the Attack Prevention Function

After all parameters for attack prevention are set, you can start up the attack prevention function. Note that small parts of processor source will be occupied when the attack prevention function is started.

Command	Description
filter enable	Starts up the attack prevention function.

Use the **no filter enable** command to disable the attack prevention function and remove the block to all attack sources.

42.1.3.4 Checking the State of Attack Prevention

After attack prevention is started, you can run the following command to check the state of attack prevention:

Command	Description
show filter	Checks the state of attack prevention.

42.1.4 Attack Prevention Configuration Example

To enable the IGMP attack prevention and the ARP attack prevention on port 1/2, consider any host that sends more than 1200 pieces of message within 15 seconds as the attack source and to cut off network service for any attack source.

```
filter period 15
filter threshold 1200
filter block-time 600
interface f1/2
filter arp
exit
filter enable
```

Chapter 43. Network Protocol Configuration

43.1 Configuring IP Addressing

43.1.1 IP Introduction

43.1.1.1 IP

Internet Protocol (IP) is a protocol in the network to exchange data in the text form. IP has the functions such as addressing, fragmenting, regrouping and multiplexing. Other IP protocols (IP protocol cluster) are based on IP. As a protocol working on the network layer, IP contains addressing information and control information which are used for routing.

Transmission Control Protocol (TCP) is also based on IP. TCP is a connection-oriented protocol which regulates the format of the data and information in data transmission. TCP also gives the method to acknowledge data is successfully reached. TCP allows multiple applications in a system to communicate simultaneously because it can send received data to each of the applications respectively.

The IP addressing, such as Address Resolution Protocol, are to be described in section 1.3 “Configuring IP Addressing.” IP services such as ICMP, HSRP, IP statistics and performance parameters are to be described in Chapter 4 “Configuring IP Services.”

43.1.1.2 IP Routing Protocol

Our routing switch supports multiple IP routing dynamic protocols, which will be described in the introduction of each protocol.

IP routing protocols are divided into two groups: Interior Gateway Routing Protocol (IGRP) and Exterior Gateway Routing Protocol (EGRP). Our routing switch supports RIP, OSPF, BGP and BEIGRP. You can configure RIP, OSPF, BGP and BEIGRP respectively according to your requirements. Our switch also supports the process that is to configure multiple routing protocols simultaneously, a random number of OSPF processes (if memory can be distributed), a BGP process, a RIP process and a random number of BEIGRP processes. You can run the **redistribute** command to redistribute the routes of other routing protocols to the database of current routing processes, connecting the routes of multiple protocol processes.

To configure IP dynamic routing protocols, you must first configure relevant processes, make relevant network ports interact with dynamic routing processes, and then designate routing processes to be started up on the ports. To do this, you may check configuration steps in configuration command documents.

43.1.1.3 Choosing routing protocol

It is a complex procedure to choose routing protocol. When you choose the routing protocol, consider the following items:

- Size and complexity of the network
- Whether the length-various network need be supported

- Network traffic
- Safety requirements
- Reliability requirements
- Strategy
- Others

Details of the above items are not described in the section. We just want to remind you that your network requirements must be satisfied when you choose the routing protocols.

43.1.1.4 IGRP

Interior Gateway Routing Protocol (IGRP) is used for network targets in an autonomous system. All IP IGRPs must be connected with networks when they are started up. Each routing process monitors the update message from other routing switches in the network and broadcasts its routing message in the network at the same time. The IGRPs that our routing switches support include:

- RIP
- OSPF
- BEIGRP

43.1.1.5 EGRP

Exterior Gateway Routing Protocol (EGRP) is used to exchange routing information between different autonomous systems. Neighbors to exchange routes, reachable network and local autonomous system number generally need to be configured. The EGRP protocol that our switch supports is BGP.

43.1.2 Configuring IP Address Task List

An essential and mandatory requirement for IP configuration is to configure the IP address on the network interface of the routing switch. Only in this case can the network interface be activated, and the IP address can communicate with other systems. At the same time, you need to confirm the IP network mask.

To configure the IP addressing, you need to finish the following tasks, among which the first task is mandatory and others are optional.

For creating IP addressing in the network, refer to section 1.4 “IP Addressing Example.”

Followed is an IP address configuration task list:

- Configuring IP address at the network interface
- Configuring multiple IP addresses at the network interface
- Configuring address resolution
- Configuring routing process
- Configuring broadcast text management
- Detecting and maintaining IP addressing

43.1.3 Configuring IP Address

43.1.3.1 Configuring IP Address at Network Interface

The IP address determines the destination where the IP message is sent to. Some IP special addresses are reserved and they cannot be used as the host IP address or network address. Table 1 lists the range of IP addresses, reserved IP addresses and available IP addresses.

Type	Address or Range	State
A	0.0.0.0	Reserved
	1.0.0.0 to 126.0.0.0	Available
	127.0.0.0	Reserved
B	128.0.0.0 to 191.254.0.0	Available
	191.255.0.0	Reserved
C	192.0.0.0	Reserved
	192.0.1.0 to 223.255.254	Available
	223.255.255.0	Reserved
D	224.0.0.0 to 239.255.255.255	Multicast address
	240.0.0.0 to 255.255.255.254	Reserved Broadcast
E	255.255.255.255	
	255.255.255.255	

The official description of the IP address is in RFC 1166 “Internet Digit”. You can contact the Internet service provider.

An interface has only one primary IP address. Run the following command in interface configuration mode to configure the primary IP address and network mask of the network interface:

Run...	To...
ip address <i>ip-address mask</i>	Configure the main IP address of the interface.

The mask is a part of the IP address, representing the network.



Our switches only support masks which are continuously set from the highest byte according to the network character order.

43.1.3.2 Configuring Multiple IP Addresses on Network Interface

Each interface can possess multiple IP addresses, including a primary IP address and multiple subordinate IP addresses. You need to configure the subordinate IP addresses in the following two cases:

- If IP addresses in a network segment are insufficient.

For example, there are only 254 available IP addresses in a certain logical subnet, however, 300 hosts are

needed to connect the physical network. In this case, you can configure the subordinate IP address on the switch or the server, enabling two logical subnets to use the same physical subnet. Most of early-stage networks which are based on the layer-2 bridge are not divided into multiple subnets. You can divide the early-stage network into multiple route-based subnets by correctly using the subordinate IP addresses. Through the configured subordinate IP addresses, the routing switch in the network can know multiple subnets that connect the same physical network.

- If two subnets in one network are physically separated by another network.

In this case, you can take the address of the network as the subordinate IP address. Therefore, two subnets in a logical network that are physically separated, therefore, are logically connected together.



If you configure a subordinate address for a routing switch in a network segment, you need to do this for other routing switches in the same network segment.

Run the following command in interface configuration mode to configure multiple IP addresses on the network interface.

Run...	To...
ip address <i>ip-address mask</i> secondary	Configure multiple IP addresses on the network interface.



When the IP routing protocol is used to send the route update information, subordinate IP addresses may be treated in different ways.

43.1.3.3 Configuring Address Resolution

IP can realize functions such as IP address resolution control. The following sections show how to configure address resolution:

1. Creating address resolution

An IP device may have two addresses: local address (local network segment or device uniquely identified by LAN) and network address (representing the network where the device is located). The local address is the address of the link layer because the local address is contained in the message header at the link layer, and is read and used by devices at the link layer. The professionals always call it as the MAC address. This is because the MAC sub layer in the link layer is used to process addresses.

For example, if you want your host to communicate with a device on Ethernet, you must know the 48-bit MAC address of the device or the local address of the link layer. The process on how to obtain the local address of the link layer from the IP address is called as Address Resolution Protocol (ARP). The process on how to obtain the IP address from the local address of the link layer is called as Reverse Address Resolution (RARP).

Our system adopts address resolution in two types: ARP and proxy ARP. The ARP and proxy ARP are defined in RFC 860 and 1027 respectively.

ARP is used to map IP addresses to media or MAC address. When the IP address is known, ARP will find the corresponding MAC address. When the MAC address is known, the mapping relationship between IP address and MAC address is saved in ARP cache for rapid access. The IP message is then packaged in the message at the link layer and at last is sent to the network.

- Defining a static ARP cache

ARP and other address resolution protocols provide a dynamic mapping between IP address and MAC address. The static ARP cache item is generally not required because most hosts support dynamic address resolution. You can define it in global configuration mode if necessary. The system utilizes the static ARP cache item to translate the 32-bit IP address into a 48-bit MAC address. Additionally, you can specify the routing switch to respond to the ARP request for other hosts.

You can set the active period for the ARP items if you do not want the ARP item to exist permanently. The following two types show how to configure the mapping between the static IP address and the MAC address.

Run one of the following commands in global configuration mode:

Run...	To...
arp ip-address hardware-address	Globally map an IP address to a MAC address in the ARP cache.
arp ip-address hardware-address alias	Specify the routing switch to respond to the ARP request of the designated IP address through the MAC address of the routing switch.

Run the following command in interface configuration mode:

Run...	To...
arp timeoutseconds	Set the timeout time of the ARP cache item in the ARP cache.

Run show interfaces to display the ARP timeout time of the designated interface. Run the show arp to check the content of the ARP cache. Run clear arp-cache to delete all items in the ARP cache.

- Activating proxy ARP

The system uses the proxy ARP (defined by RFC 1027) to obtain the host's MAC address on other networks for the hosts without corresponding routes. For example, when the routing switch receives an ARP request and finds that the source host and the destination host are not connected to the same interface and all the routes that the routing switch reaches the destination host are not through the interface that receives the ARP request, it will send a proxy ARP response that contains its address of the link layer. The source host then sends the message to the routing switch and the switch forwards it to the destination host. The proxy ARP is activates by default.

To activate the proxy ARP, run the following command in interface configuration mode:

Run...	To...
ip proxy-arp	Activate the proxy ARP on the interface.

- **Configuring free ARP function**

The switch can know whether the IP addresses of other devices collide with its IP address by sending free ARP message. The source IP address and the destination IP address contained by free ARP message are both the local address of the switch. The source MAC address of the message is the local MAC address. The switch processes free ARP message by default. When the switch receives free ARP message from a device and finds that the IP address contained in the message collide with its own IP address, it will return an ARP answer to the device, informing the device that the IP addresses collide with each other. At the same time, the switch will inform users by logs that IP addresses collide.

The switch's function to send free ARP message is disabled by default. Run the following commands to configure the free ARP function on the port of the switch:

Run...	To...
arp send-gratuitous	Start up free ARP message transmission on the interface.
arp send-gratuitous intervalvalue	Set the interval for sending free ARP message on the interface. The default value is 120 seconds.

2. Mapping host name to IP address

Any IP address can correspond to a host name. The system stores a hostname-to-address mapping cache that you can telnet or ping.

Run the following command in global configuration mode to specify a mapping between host name and IP address:

Run...	To...
ip hostname address	Statically map the host name to the IP address.

43.1.3.4 Configuring Routing Process

You can configure one or multiple routing protocols according to your actual network requirements. The routing protocol provides information about the network topology. The details about configuring IP routing protocols such as BGP, RIP and OSPF are shown in the following sections.

43.1.3.5 Configuring Broadcast Message Handling

The destination addresses of the broadcast message are all the hosts on a physical network. The host can

identify the broadcast message through special address. Some protocols, including some important Internet protocols, frequently use the broadcast message. One primary task of the IP network administrator is to control the broadcast message. The system supports the directed broadcast, that is, the broadcast of designated network. The system does not support the broadcast of all subnets in a network.

Some early-stage IP's do not adopt the current broadcast address standard. The broadcast address adopted by these IP's is represented completely by the number "0". The system can simultaneously identify and receive message of the two types.

1. Allowing translating from directed broadcast to physical broadcast

The directed IP broadcast message will be dropped by default, preventing the switch from attacking by message "service rejected".

You can activate the function of forwarding directed IP broadcast on the interface where the directed broadcast is transformed to the physical message. If the forwarding function is activated, all the directed broadcast message of the network that connects the interface will be forwarded to the interface. The message then will be sent as the physical broadcast message.

You can designate an access table to control the forwarding of broadcast message. After the access table is specified, only IP message that the access table allows can be transformed from the directed broadcast to the physical broadcast.

Run the following command in interface configuration mode to activate the forwarding of the directed broadcast.

Run...	To...
ip directed-broadcast [<i>access-list-name</i>]	Allow the translation from the directed broadcast to the physical broadcast on the interface.

2. Forwarding UDP broadcast message

Sometimes, the host uses the UDP broadcast message to determine information about the address, configuration and name, and so on. If the network where the host is located has no corresponding server to forward the UDP message, the host cannot receive any of the UDP message. To solve the problem, you can do some configuration on the corresponding interface to forward some types of broadcast message to an assistant address. You can configure multiple assistant addresses for an interface.

You can designate a UDP destination port to decide which UDP message is to be forwarded. Currently, the default forwarding destination port of the system is port 137.

Run the following command in interface configuration mode to allow message forwarding and to specify the destination address:

Run...	To...
ip helper-address <i>address</i>	Allow to forward the UDP broadcast message and to specify the destination address.

Run the following command in global configuration mode to specify protocols to be forwarded:

Run...	To...
ip forward-protocol udp [<i>port</i>]	Specify which interfaces' UDP protocols will be forwarded.

43.1.3.6 Detecting and Maintaining IP Addressing

Perform the following operations to detect and maintain the network:

1. Clearing cache, list and database

You can clear all content in a cache, list or the database. When you think some content is ineffective, you can clear it.

Run the following command in management mode to clear the cache, list and database:

Run...	To...
clear arp-cache	Clear the IP ARP cache.

2. Displaying statistics data about system and network

The system can display designated statistics data, such as IP routing table, cache and database. All such information helps you know the usage of the systematic resources and solve network problems. The system also can display the reachability of the port and the routes that the message takes when the message runs in the network.

All relative operations are listed in the following table. For how to use these commands, refer to Chapter "IP Addressing Commands".

Run the following commands in management mode:

Run...	To...
show arp	Display content in the ARP table.
show hosts	Display the cache table about hostname-to-IP mapping.
show ip interface [<i>type number</i>]	Display the interface state.
show ip route [<i>protocol</i>]	Display the current state of the routing table.
ping { <i>host</i> <i>address</i> }	Test the reachability of the network node.

43.1.3.7 IP Addressing Example

The following case shows how to configure the IP address on interface VLAN 11.

```
interface vlan 11
```

```
ip address 202.96.2.3 255.255.255.0
```

43.2 Configuring NAT

43.2.1 Introduction

The Internet faces two key problems: insufficient IP address space and route measurement. Network Address Translation (NAT) is an attribute. You can find that a group of IP networks with this attribute use different IP address spaces, but you cannot find the actual address space used by the group of networks. By transforming these addresses to the address spaces that can be globally routed, NAT permits an organization without global routing addresses to connect the Internet. NAT also permits good recoding strategy to change the service providers for the organizations or to automatically code to the CIDR module. NAT will be described in RFC 1631.

43.2.1.1 NAT Application

Main NAT applications are shown as follows:

- All hosts need to connect to the Internet, but not all hosts have a unique global IP address. NAT enables unregistered networks with private IP addresses to connect the Internet. NAT are always configured at the routing switch between inside network and Internet. Before sending message to the Internet, NAT transfers the inside local address to the unique global IP address.
- The inside address has to be modified. You can transform the address by using NAT without too much time.
- The basic TCP transmission load balance need be realized. You can map a single global IP address to multiple IP addresses using TCP load distribution characteristic.
- As a resolution for connection problems, NAT can be used when relatively few hosts in an inside network communicate with the Internet. In this case, the IP addresses of few hosts will be transformed to a unique global IP address when they communicate with the Internet. These addresses can be reused when they are not used any more.

43.2.1.2 NAT Advantage

An obvious advantage of NAT is that you can perform configuration without modifying host or switch. As said above, NAT is useless if many hosts in a single-connection domain communicate with the outside. What's more, the NAT device is not suitable to translate the embedded IP address. These applications cannot work transparently or completely (without translation) pass through a NAT device. NAT hides the identifier of the host, which may be an advantage or a shortcoming.

The router configured with NAT has at least one inside interface and one outside interface. In typical case, NAT is configured at the router between the single-connection domain and the backbone domain. When a message is leaving the single-connection domain, NAT transforms the effective local address to a unique global address. When the message reaches the domain, NAT transforms the unique global address to the local address. If multiple interfaces exist, each NAT must have the same the transfer table. If no address is available, the software cannot distribute an address and NAT will drop the message and returns an ICMP

message indicating the host cannot be reached.

The switch with NAT configured should not publish the local network. However, the routing information that NAT receives from the outside can be published in the single-connection domain.

43.2.1.3 NAT Terms

As said above, the term “inside” means those networks which are possessed by organizations and have to be transformed. In this domain, the host has an address in one address space. At the outside, the host will possess an address in another address space when the NAT is configured. The first address space means the local address space, while the second address space means the global address space.

Similarly, the term “outside” means the network that the single network connects, generally out of control of an organization. The addresses of the hosts in the outside network need to translate a certain address and may be classified into two types of addresses: local address and global address.

NAT uses the following definitions:

- Inside local address: IP address that is allocated to a host in the inside network. The address may not be the legal IP address distributed by Network Information Center (NIC) or service provider (SP).
- Inside global address: legal IP address distributed by NIC or SP, describing one or multiple IP addresses for the outside network.
- Outside local address: IP address of the outside host that appears in the inside network. It may be illegal. It can be distributed through the routable address space in the inside network.
- Outside global address: IP address that the owner of the host distributes to the host in the outside network, which can be distributed from the global address space or the network space.

43.2.1.4 NAT Regulation Matching Order

When NAT translates message, the configured NAT regulations must first be matched. There are three classes of NAT regulations: inside source address mapping, outside source address mapping and inside destination address mapping. Each class has its own subclasses. The following case takes the inside source address mapping as an example to introduce the subclass order of the NAT matching regulations:

- Static TCP/UDP port mapping regulation
- Static single address mapping regulations
- Static network segment mapping regulations
- Dynamic POOL address mapping regulations
- PAT mapping regulations

The regulations in the same subclass in the same class and the three classes are matched according the sequence they are being added. When you run the **show running** command, the order to display the NAT regulations is the same as the actual matching order.

43.2.2 NAT Configuration Task List

Before configuring any NAT, you must know the range of the inside local address and inside global address.

The NAT configuration task list is shown as follows:

- Translating inside source address
- Reloading inside global address
- Translating the overlapping address
- Providing TCP load balance
- Changing translation timeout time and limiting the number of connections
- Monitoring and maintaining NAT

43.2.3 NAT Configuration Task

43.2.3.1 Translating Inside Source Address

When the host communicates with the outside network, it uses the attribute (translating inside source address) to translate its IP address to the unique global IP address. You can configure the static or dynamic inside source address translation through the following method:

The static translation creates the one-to-one mapping between inside local address and inside global address.

When an inside host is accessed by a fixed outside address, the static translation is useful.

The dynamic translation creates the mapping between inside local address and outside address pool.

The following figure shows a routing switch translates the source address inside a network to the source address outside the network.

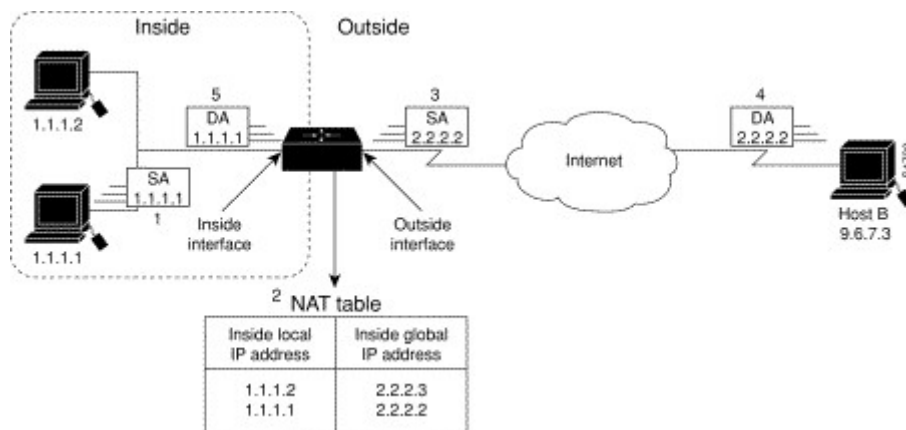

Figure 43-1 NAT Inside Source Address Transfer

The following steps show the inside source address translation.

- (1) The user of host 1.1.1.1 creates a connection between host 1.1.1.1 and host B.
- (2) The first packet received by the routing switch from host 1.1.1.1 makes the routing switch check the NAT table.

If a static translation item has been configured, the switch is to perform step 3.

If no translation exists, the switch decides that the source address (SA) 1.1.1.1 must be translated dynamically, then chooses a legal global address from the dynamic address pool, and finally generates a translation item. The type item is called as simple item.

- (3) The routing switch replaces the inside local source address with the global address of the transfer item and forwards the message.
- (4) Host B receives the message through inside global IP destination address (DA) 2.2.2.2 and responds to

host 1.1.1.1.

- (5) When the routing switch receives message of the inside global IP address, it takes the inside global address as a keyword to query the NAT table, translates the address to the inside local address of host 1.1.1.1, and forwards message to host 1.1.1.1.
- (6) Host 1.1.1.1 receives the message and continues the session. The routing switch is to perform step 2 and step 5 for each message.

1. Configuring static transfer

Run the following commands in global configuration mode to configure static inside source address transfer:

Run...	To...
ip nat inside source static <i>local-ip global-ip</i>	Create a static transfer between inside local address and inside global address.
interface <i>type number</i>	Specify the inside interface.
ip nat inside	Label the interface as one to connect the inside network.
interface <i>type number</i>	Specify the outside interface.
ip nat outside	Label the interface as one to connect the outside network.

The above is the minimum configuration. You can configure multiple inside and outside interfaces.

2. Configuring dynamic transfer

Run the following commands in global configuration mode to configure dynamic inside source address translation.

Run...	To...
ip nat pool name start-ip end-ip netmask	Define a to-be-allocated global address pool according to your requirements.
ip access-list standard access-list-name permit source [source-mask]	Define a standard access list to permit which address can be transferred.
ip nat inside source list access-list-name pool name	Create dynamic source address transfer and specify the access list that is defined at the previous step.
interface type number	Specify the inside interface.
ip nat inside	Label the interface as one to connect the inside network.
interface type number	Specify the outside interface.
ip nat outside	Label the interface as one to connect the outside network.

Only those transferable addresses can be contained in the access list (remember that an implicit item “deny all” exists at the end of each access list). The random access list may lead to unexpected results.



Note

Refer to section 2.4.1 “Dynamic Inside Source Address Transfer Example” for details.

43.2.3.2 Reloading Inside Global Address

Multiple local addresses use one global address through the routing switch. All the addresses can be stored in the inside global address pool. When the reloading is configured, the routing switch maintains sufficient information from high-level protocols (such as TCP or UDP) and transfers the global address to the correct local address. When multiple local addresses are mapped to one global address, TCP or UDP port numbers of each inside host are used to label multiple local addresses.

The following figure shows the NAT operation when an inside global address represents multiple local addresses. TCP port number is used to label the local address.

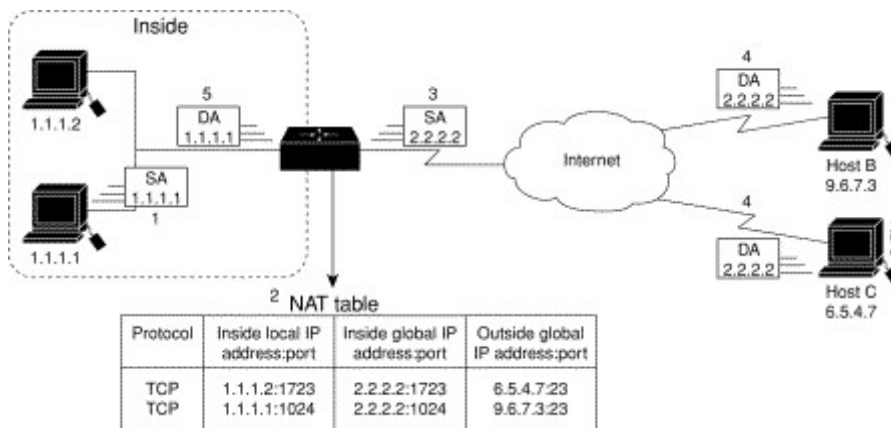

Figure 43-2 NAT Operation During the Reloading of Inside Global Address

The routing switch performs the following steps in the reloaded inside global address. Host B and host C think that they are communicating with host 2.2.2.2. However, they are communicating with different hosts in fact. The port number is the identifier. In fact, multiple inside hosts can share one inside global IP address using different port numbers.

- (1) The user of host 1.1.1.1 creates a connection between host 1.1.1.1 and host B.
- (2) The routing switch receives the first message from host 1.1.1.1 and then checks its NAT table. If no transfer items exist, the switch decides that address 1.1.1.1 must be translated, and then creates a translation between inside local address 1.1.1.1 and legal global address. If the reloading is successful, another translation is started up. The switch reuses the global address in the previous translation and saves sufficient transferable information. The item is called as the expansion item.
- (3) The routing switch replaces the inside local source address 1.1.1.1 with the selected global address, and then forwards a packet.
- (4) Host B receives the packet and responds to host 1.1.1.1 using inside global IP address 2.2.2.2.
- (5) When the routing switch receives the packet with the inside global IP address, it uses the protocol,

inside global address, outside address and port as the keywords to search the NAT table. After that, it transfers the address to the inside local address 1.1.1.1 and forwards the packet to host 1.1.1.1.

- (6) Host 1.1.1.1 receives the packet and continues the session. The routing switch performs step 2 and step 5 for each packet.

Run the following commands in global configuration mode to configure the reloading of the inside global address:

Run...	To...
ip nat pool name start-ip end-ip netmask	Define a to-be-distributed global address pool according to requirements.
ip access-list standard access-list-name permit source [source-mask]	Define a standard access list.
ip nat inside source list access-list-name pool name overload	Create dynamic inside source address transfer and decide the access list previously defined.
interface type number	Specify the inside interface.
ip nat inside	Label the interface as one to connect the inside network.
interface type number	Specify the outside interface.
ip nat outside	Label the interface as one to connect the outside network.



Only those transferable addresses can be contained in the access list (remember that an implicit item “deny all” exists at the end of each access list). The random access list may lead to unexpected results.

Refer to section 2.4.2 “Inside Global Address Reloading Example” for details.

43.2.3.3 Translating Overlapping Addresses

When an internal local address is the same as the to-be-connected outside address, address overlapping occurs. The following figure shows how NAT translates the overlapping addresses.

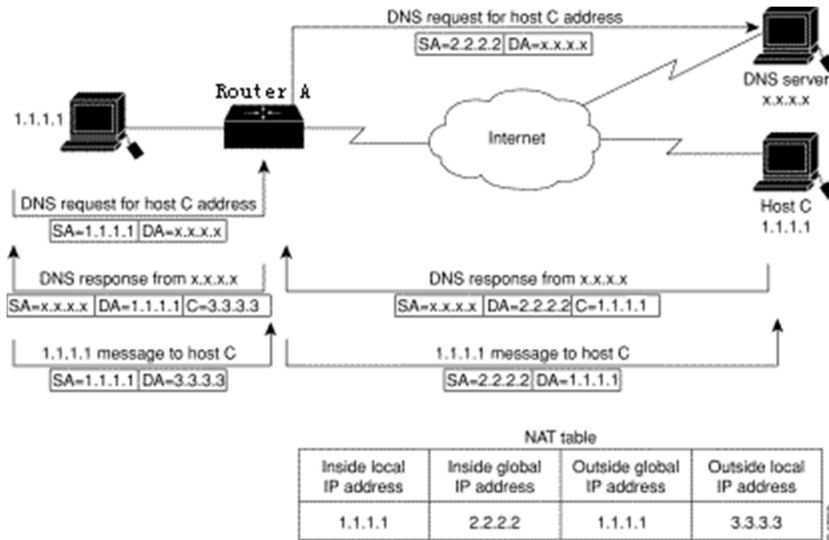

Figure 43-3 Network Condition Where NAT Translates Overlapping Addresses

The routing switch performs the following steps when translating the overlapping addresses:

- (1) The user of host 1.1.1.1 uses domain name to send instructions for connecting host C. Host 1.1.1.1 requires DNS server to perform a checkup from domain name to address.
- (2) The DNS server responds the request and returns the address 1.1.1.1 of host C. The routing switch intercepts the DNS response message and selects an outside local address from the outside local address pool to replace the source address. In this case, the source address 1.1.1.1 is replaced with address 3.3.3.3.
- (3) The routing switch creates a mapping table about address transfer, where inside local addresses and inside global addresses map each other, outside global address and outside local address map each other.
- (4) Host 1.1.1.1 sends message to host C . The destination IP address is the outside local address 3.3.3.3.
- (5) When switch A receives message whose destination address is the outside local address, switch A transfers the local address to the global address.
- (6) Host C receives the packet and continues the session.

1. Configuring static transfer

Run the following commands in global configuration mode to configure static source address translation:

Run...	To...
ip nat outside source static <i>global-ip local-ip</i>	Creates static translation between outside local address and outside global address.
interface <i>type number</i>	Specify the inside interface.
ip nat inside	Label the interface as one to connect the inside network.
interface <i>type number</i>	Specify the outside interface.
ip nat outside	Label the interface as one to connect the

	outside network.
--	------------------

2. Configuring dynamic transfer

Run the following commands in global configuration mode to configure dynamic outside source address transfer:

Run...	To...
ip nat poolname start-ip end-ip netmask	Define a to-be-distributed local address pool according to requirements.
ip access-list standardaccess-list-namepermit source [source-mask]	Define a standard access list.
ip nat outside source listaccess-list-name poolname	Create dynamic outside source address transfer and decide the access list previously defined.
interfacetype number	Specify the inside interface.
ip nat inside	Label the interface as one to connect the inside network.
interface type number	Specify the outside interface.
ip nat outside	Label the interface as one to connect the outside network.



Only those transferable addresses can be contained in the access list (remember that an implicit item “deny all” exists at the end of each access list). The random access list may lead to unexpected results.

For details, refer to section “Overlapping Address Translation Example”.

43.2.3.4 Providing TCP Load Balance

Another fashion of using NAT is unrelated to the Internet address. Your organization may have multiple hosts to communicate with a frequently used host. In this case, you can use NAT technology to create a virtual host in the inside network, helping the load balance among actual hosts. You need to replace the destination address of the access list with the address in the cycle address pool. The distribution is complete in a cycle when a new connection from the outside to the inside is opened. The non-TCP communication need not be translated (unless other translations are effective). The following figure illustrates the attribute.

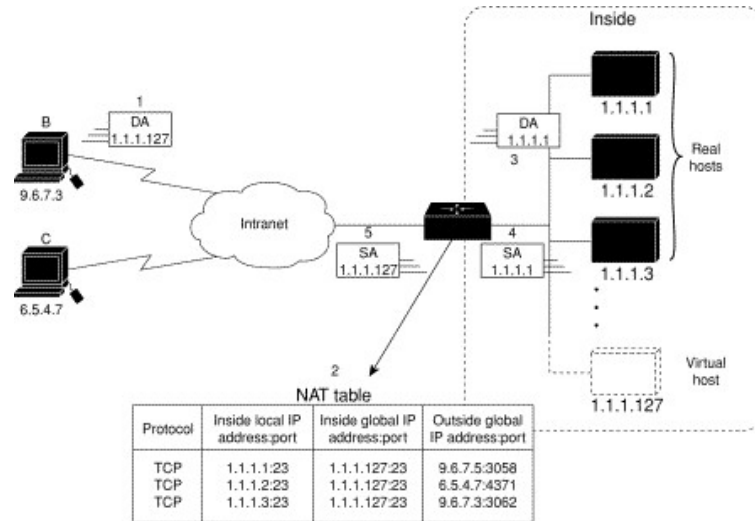

Figure 43-4 NAT TCP load balance

When translating the cycle address, the routing switch performs the following steps:

- (1) The user of host B (9.6.7.3) sends instructions for connecting the virtual host 1.1.1.127 in the inside network.
- (2) The routing switch receives the connection request and creates a new translation item to allocate the next host 1.1.1.1 for the inside local IP address.
- (3) The routing switch replaces the destination address with the selected actual address of the host, and forwards the message.
- (4) Host 1.1.1.1 receives the message and makes response.
- (5) The routing switch receives the message and uses the inside local addresses and their port numbers, the outside address and port number as keywords to check the NAT table. The routing switch then transfers the source address to the address of the virtual host, and forwards the message.
- (6) Next connection request invokes the routing switch to distribute address 1.1.1.2 for the inside local address. To configure the destination address transfer, run the following commands in global configuration mode. These commands permit to map one virtual host to multiple real hosts. Each TCP session with the virtual host will be transferred to the sessions with different real hosts.

Run...	To...
ip nat pool name start-ip end-ip netmask	Define an address pool containing the addresses of real hosts.
ip access-list standard access-list-name permit source [source-mask]	Define an access table permitting addresses of virtual hosts.
ip nat inside destination list access-list-name pool name	Create a dynamic inside target transfer mechanism and confirm the previously defined access list.
interface type number	Specify the inside interface.

ip nat inside	Label the interface as one to connect the inside network.
interface type number	Specify the outside interface.
ip nat outside	Label the interface as one to connect the outside interface.



Only those transferable addresses can be contained in the access list (remember that an implicit item “deny all” exists at the end of each access list). The random access list may lead to unexpected results.

For details, refer to section “TCP Load Configuration Example”.

43.2.3.5 Changing Translation Timeout Time and Limiting the Number of Connections

After a period of leisure, the dynamic Network Address Translation (NAT) is to time out by default. If the reloading is not configured, the simple translation item is to time out after one hour. You can run the following command to in global configuration mode to change the timeout value.

Run...	To...
ip nat translation timeoutseconds	Change the timeout value of the dynamic NAT without reloading.

If the reloading is configured, the translation timeout will be better controlled because every translation item contains more contents. To change the timeout value of the expansible item, run one or most of the following commands in global configuration mode.

Run...	To...
ip nat translation udp-timeout seconds	Change the UDP timeout value (the default value is five seconds).
ip nat translation dns-timeoutseconds	Change the DNS timeout value (the default value is one second).
ip nat translation tcp-timeout seconds	Change the TCP timeout value (the default value is one hour).
ip nat translation icmp-timeoutseconds	Set the timeout time of the ICMP NAT (the default time is 60 seconds).
ip nat translation syn-timeoutseconds	Set the timeout time of the NAT in the TCP SYN state (the default time is 60 seconds).
ip nat translation finrst-timeout seconds	Change the TCP FIN/RST timeout value (the default value is 60 seconds).

There are three methods to limit the NAT connections. Run the following commands in global configuration mode to realize the three methods.

Run...	To...
ip nat translation max-entries <i>numbers</i>	Set the maximum number of the translation items (the default value is 4000).
ip nat translation max-links A.B.C.D <i>numbers</i>	Limit the maximum number of the NAT connection items that the designated inside IP address creates. There is no default value.
ip nat translation max-links all <i>numbers</i>	Limit the maximum number of the NAT connection items that a single IP address creates. The default value is the same as max-entries.

43.2.3.6 Monitoring and Maintaining NAT

The dynamic NAT is to time out by default according to the time regulated by the NAT transfer table. You can run the following commands in management mode to clear up the timeout item before the timeout occurs.

Run...	To...
clear ip nat translation	Clear up all transfer items from the NAT transfer table.
clear ip nat translation inside <i>local-ip global-ip</i> [outside <i>local-ip global-ip</i>]	Clear up a simple dynamic translation item containing inside translation, outside translation or both.
clear ip nat translation outside <i>local-ip global-ip</i>	Clear up a simple dynamic translation item containing outside translation.
clear ip nat translation inside <i>local-ip local-port global-ip global-port</i> [outside <i>local-ip local-port global-ip global-port</i>]	Clear up expansible dynamic translation items.

Run one of the following commands in management mode to display the transfer information:

Run...	To...
show ip nat translations [verbose]	Display active translation.
show ip nat statistics	Display translation statistics.

43.2.4 NAT Configuration Example

43.2.4.1 Dynamic Inside Source Transfer Example

The following example shows how to transfer all source addresses (192.168.1.0/24) that matches access list a1 to one address in the net-208 pool whose address range is from 171.69.233.208 to 171.69.233.233.

```
ip nat pool net-208 171.69.233.208 171.69.233.233 255.255.255.240
```

```
ip nat inside source list a1 pool net-208
!
interface vlan10
 ip address 171.69.232.182 255.255.255.240
 ip nat outside
!
interface vlan11
 ip address 192.168.1.94 255.255.255.0
 ip nat inside
!
ip access-list standard a1
 permit 192.168.1.0 255.255.255.0
!
```

43.2.4.2 Inside Global Address Reloading Example

An address pool named net-208 is created in the following example. The address pool contains all addresses from 171.69.233.208 to 171.69.233.233. The a1 access list permits all packets from source addresses from 192.168.1.0 to 192.168.1.255. If there is no transfer, packets matching the a1 access list are to be transferred to one address the net-208 address pool. The routing switch authorizes multiple local addresses (from 192.168.1.0 to 192.168.1.255) to use the same global address. The routing switch stores the port numbers to distinguish every connection.

```
ip nat pool net-208 171.69.233.208 171.69.233.233 255.255.255.240
ip nat inside source list a1 pool net-208 overload
!
interface vlan10
 ip address 171.69.232.182 255.255.255.240
 ip nat outside
!
interface vlan11
 ip address 192.168.1.94 255.255.255.0
 ip nat inside
!
ip access-list standard a1
 permit 192.168.1.0 255.255.255.0
!
```

43.2.4.3 Example to overlapping address transfer

The following example shows that other users in the Internet are legally using the address in the local network. Extra transfer is needed to access the outside network. The net-10 address pool is an outside local IP

address pool. The sentence **ip nat outside source list 1 pool net-10** transfer the host addresses of the outside overlapping network to the address in the net-10 address pool.

```
ip nat pool net-208 171.69.233.208 171.69.233.223 255.255.255.240
```

```
ip nat pool net-10 10.0.1.0 10.0.1.255 255.255.255.0
```

```
ip nat inside source list a1 pool net-208
```

```
ip nat outside source list a1 pool net-10
```

```
!
```

```
interface vlan10
```

```
ip address 171.69.232.192 255.255.255.240
```

```
ip nat outside
```

```
!
```

```
interface vlan11
```

```
ip address 192.168.1.94 255.255.255.0
```

```
ip nat inside
```

```
!
```

```
ip access-list standard a1
```

```
permit 192.168.1.0 255.255.255.0
```

```
!
```

43.2.4.4 TCP Load Distribution Example

The following example shows that the connections between a virtual address and a group of actual hosts are distributed. The address pool defines the addresses of actual hosts. The access list defines the virtual address. The TCP packet that matches the access list and is from serial port 1/0 (outside interface) is to be translated to the address in the pool.

```
ip nat pool real-hosts 192.168.15.2 192.168.15.15 255.255.255.240
```

```
ip nat inside destination list a2 pool real-hosts
```

```
!
```

```
interface vlan10
```

```
ip address 192.168.15.129 255.255.255.240
```

```
ip nat outside
```

```
!
```

```
interface vlan11
```

```
ip address 192.168.15.17 255.255.255.240
```

```
ip nat inside
```

```
!
```

```
ip access-list standard a2
```

```
permit 192.168.15.1 255.255.255.0
```

43.3 Configuring DHCP

43.3.1 Introduction

The Dynamic Host Configuration Protocol (DHCP) provides some parameters of network configuration for hosts in the Internet. DHCP will be described in RFC 2131. The most important function of DHCP is to distribute IP addresses on the interface. DHCP supports three mechanisms of distributing IP addresses.

- Automatic distribution

The DHCP server automatically distributes a permanent IP address to a client.

- Dynamic distribution

The DHCP server distributes an IP address for a client to use for a certain period of time or until the client does not use it.

- Manual distribution

The administrator of the DHCP server manually specifies an IP address and through the DHCP protocol sends it to the client.

43.3.1.1 DHCP Applications

DHCP has several kinds of applications. You can use DHCP in the following cases:

- You can distribute IP address, network segment and related sources (such as relevant gateway) to an Ethernet interface by configuring the DHCP client.
- When a switch that can access DHCP connects multiple hosts, the switch can obtain an IP address from the DHCP server through the DHCP relay and then distribute the address to the hosts.

43.3.1.2 DHCP Advantages

In current software version, the DHCP client or the DHCP client on the Ethernet interface is supported. The function to support the DHCP client has the following advantages:

- Reducing the configuration time
- Reducing configuration faults
- Controlling IP addresses of some device ports through the DHCP server

43.3.1.3 DHCP Terminology

DHCP is based on the Server/Client model. The DHCP-server and DHCP-client exist in the DHCP running conditions.

- DHCP-Server

It is a device to distribute and recycle the DHCP-related sources such as IP addresses and lease time.

- DHCP-Client

It is a device to obtain information from the DHCP server for devices of the local system to use, such as IP address information.

As described above, the lease time is a concept appearing in the procedure of DHCP dynamic distribution.

- Lease time

an effective period of an IP address since its distribution. When the effective period is over, the IP address is to be recycled by the DHCP server. To continuously use the IP address, the DHCP client requires re-applying the IP address.

43.3.2 Configuring DHCP Client

43.3.2.1 DHCP Client Configuration Tasks

- Obtaining an IP address
- Specifying an address for DHCP server
- Configuring DHCP parameters
- Monitoring DHCP

43.3.2.2 DHCP Client Configuration Tasks

1. Obtaining an IP address

Run the following command on the VLAN interface to obtain an IP address through the DHCP protocol for an interface.

Run...	To...
ip address dhcp	Specify the DHCP protocol to configure the IP address of the Ethernet interface.

2. Specifying an address for DHCP server

If the addresses of some DHCP servers are known, you can specify the addresses for these DHCP servers on the switch to reduce protocol interaction time. Run the following command in global configuration mode:

Run...	To...
ip dhcp-server <i>ip-address</i>	Specify the IP address of the DHCP server.

The command is optional when you perform operations to obtain an IP address.

3. Configuring DHCP parameters

You can adjust the parameters for the DHCP protocol interaction according to requirements. Run the following commands in global configuration mode:

Run...	To...
ip dhcp client minlease <i>seconds</i>	Specify the minimum lease time.
ip dhcp client retransmit <i>count</i>	Specify the times of resending protocol message.

ip dhcp client select seconds	Specify the interval for SELECT.
--------------------------------------	----------------------------------

The command is optional when you perform operations to obtain an IP address.

4. Monitoring DHCP

To check information about DHCP-server currently found by switch, run the following command in management mode:

Run...	To...
show dhcp server	Display information about the DHCP server known by the routing switch.

Run the following command in management mode to check the IP address currently used by the routing switch:

Run...	To...
show dhcp lease	Display the IP address resources currently used by the routing switch and relevant information.

Additionally, if the DHCP protocol is used to distribute an IP address for an Ethernet interface, you can run **show interface** to check whether the IP address required by the Ethernet interface is successfully obtained.

43.3.2.3 DHCP Client Configuration Example

Obtaining an IP address

The following example shows Ethernet1/1 obtains an IP address through DHCP.

```
!
interface vlan 11
ip address dhcp
```

43.3.3 Configuring DHCP Server

43.3.3.1 DHCP Server Configuration Tasks

- Enabling DHCP server
- Disabling DHCP server
- Configuring ICMP detection parameter
- Configuring database storage parameter
- Configuring the address pool of DHCP server
- Configuring the parameter for the address pool of DHCP server
- Monitoring DHCP server
- Clearing information about DHCP server

43.3.3.2 Configuring DHCP Server

43.3.3.3 Enabling DHCP server

To enable the DHCP server and distribute parameters such as IP address for the DHCP client, run the following command in global configuration mode (the DHCP server also supports the relay operation. For the addresses that the DHCP server cannot distribute, the port where **ip helper-address** is configured is to forward the DHCP request):

Run...	To...
ip dhcpd enable	Enabling DHCP server.

43.3.3.4 Disabling DHCP server

To enable DHCP server and stop distributing parameters such as IP address parameter for the DHCP client, run the following command in global configuration mode:

Run...	To...
no ip dhcpd enable	Disable DHCP server.

43.3.3.5 Configuring ICMP detection parameter

You can adjust the parameter of the to-be-sent ICMP message when the server performs address detection. Run the following command in global configuration mode to configure the number of to-be-sent ICMP messages:

Run...	To...
ip dhcpd ping packets <i>pkgs</i>	Specify the times of address detection as the number of to-be-sent ICMP message.

Run the following command in global configuration mode to configure the timeout time of ICMP message response:

Run...	To...
ip dhcpd ping timeout <i>timeout</i>	Specify the timeout time of ICMP message response.

43.3.3.6 Configuring database storage parameter

To configure the interval when the address distribution information is stored in the agent database, run the following command in global configuration mode.

Run...	To...
ip dhcpd write-time <i>time</i>	Specify the interval at which the address distribution information is stored in the agent database.

43.3.3.7 Configuring DHCP server address pool

Run the following command in global configuration mode to add the address pool for the DHCP server:

Run...	To...
ip dhcpd pool <i>name</i>	Add the address pool of the DHCP server and enter the configuration mode of the DHCP address pool.

43.3.3.8 Configuring DHCP server address pool

You can run the following commands in DHCP address pool configuration mode to configure related parameters.

Run the following command to configure the network address of the address pool which is used for automatic distribution.

Run...	To...
network <i>ip-addr netsubnet</i>	Configure the network address of the address pool which is used for automatic distribution.

Run the following command to configure the address range that is used for automatic distribution.

Run...	To...
range <i>low-addr high-addr</i>	Configure the address range that is used for automatic distribution.

Run the following command to configure the default route that is distributed to the client:

Run...	To...
default-router <i>ip-addr ...</i>	Configure the default route that is distributed to the client.

Run the following command to configure the DNS server address that is distributed to the client:

Run...	To...
dns-server <i>ip-addr ...</i>	Configure the DNS server address that is distributed to the client.

Run the following command to configure domain that is distributed to the client:

Run...	To...
domain-name <i>name</i>	Configure domain that is distributed to the client.

Run the following command to configure the lease time of the address that is distributed to the client:

Run...	To...
lease { <i>days</i> [<i>hours</i>][<i>minutes</i>] <i>infinite</i> }	Configure the lease time of the address that is distributed to the client.

Run the following command to configure the netbios server address that is distributed to the client:

Run...	To...
netbios-name-server <i>ip-addr...</i>	Configure the netbios server address that is distributed to the client.

You can run the following command to reject to distribute the IP address to the host whose MAC address is hardware-address.

Run...	To...
hw-access deny hardware-address	Reject to distribute IP addresses to the host whose MAC address is hardware-address.

43.3.3.9 Monitoring DHCP server

Run the following command in management mode to check current address distribution information about DHCP server.

Run...	To...
show ip dhcpd binding	Display current address distribution information about DHCP server.

Run the following command in management mode to check current message statistics information about DHCP server.

Run...	To...
show ip dhcpd statistic	Display current message statistics information about DHCP server.

43.3.3.10 Clearing up information about DHCP server

Run the following command in management mode to delete current address distribution information about DHCP server:

Run...	To...
clear ip dhcpd binding { <i>ip-addr</i> *}	Delete the designated address distribution information.

Run the following command in management mode to delete current message statistics information about

DHCP server.

Run...	To...
clear ip dhcpd statistic	Delete current message statistics information about DHCP server

43.3.3.11 DHCP Server Configuration Example

In the following example, the timeout time of the ICMP detection packet is set to 200ms; Address pool 1 is configured and the DHCP server is enabled.

```
ip dhcpd ping timeout 2
ip dhcpd pool 1
network 192.168.20.0 255.255.255.0
range 192.168.20.211 192.168.20.215
domain-name my315
default-router 192.168.20.1
dns-server 192.168.1.3 61.2.2.10
netbios-name-server 192.168.20.1
lease 1 12 0
!
ip dhcpd enable
```

43.4 IP Service Configuration

It is to describe how to configure optional IP service. For the details of the IP service commands, refer to section “IP Service Commands”.

43.4.1 Configuring IP Service

Optional IP service configuration tasks are listed as follows:

- Managing IP connection
- Configuring performance parameters
- Configuring default gateway
- Detecting and maintaining IP network

The above operations are not mandatory. You can perform the operations according to your requirements.

43.4.1.1 Managing IP Connection

The IP protocol provides a series of services to control and manage IP connections. Most of these services are provided by ICMP. The ICMP message is sent to the host or other routing switches when the routing switch or the access server detects faults in the IP message header. ICMP is mainly defined in RFC 792. Perform the following different operations according to different IP connection conditions:

1. Sending ICMP unreachable message

If the system receives a message and cannot send it to the destination, such as no routes, the system will send an ICMP-unreachable message to the source host. The function of the system is enabled by default. If the function is disabled, you can run the following command in interface configuration mode to enable the function.

Run...	To...
ip unreachable	Enable the function to send an ICMP-unreachable message.

2. Sending ICMP redirection message

Sometimes the host selects an unfavorable route. After a routing switch on the route receives a message from the host, it is to check the routing table and then forward the message through the message-receiving interface to another routing switch that is in the same network segment as the host. In this case, the routing switch notifies the source host of directly sending the message with the destination to another routing switch without winding itself. The redirection message requires the source host to discard the original route and take more direct route suggested in the message. Many host's operating system adds a host route to its routing table. However, the routing switch is more willing to trust information obtained through the routing protocol. Therefore, the routing switch would not add the host route according to the information.

The function is enabled by default. If the hot standby routing switch protocol is configured on the interface, the function is automatically disabled. However, the function will not be automatically enabled even if the hot standby routing switch protocol is cancelled.

To enable the function, run the following command in interface configuration mode:

Run...	To...
ip redirects	Permit sending the ICMP redirection message.

3. Sending ICMP mask response message

Sometimes the host must know the network mask. To get the information, the host can send the ICMP mask request message. If the routing switch can confirm the mask of the host, it will respond with the ICMP mask response message. By default, the routing switch can send the ICMP mask response message.

To send the ICMP mask request message, run the following command in interface configuration mode:

Run...	To...
ip mask-reply	Send the ICMP mask response message.

4. Supporting route MTU detection

The system supports the IP route MTU detection mechanism defined by RFC 1191. The IP route MTU detection mechanism enables the host to dynamically find and adjust to the maximum transmission unit (MTU) of different routes. Sometimes the routing switch detects that the received IP message length is larger than

the MTU set on the message forwarding interface. The IP message needs to be segmented, but the “unsegmented” bit of the IP message is reset. The message, therefore, cannot be segmented. The message has to be dropped. In this case, the routing switch sends the ICMP message to notify the source host of the reason of failed forwarding, and the MTU on the forwarding interface. The source host then reduces the length of the message sent to the destination to adjust to the minimum MTU of the route.

If a link in the route is disconnected, the message is to take other routes. Its minimum MTU may be different from the original route. The routing switch then notifies the source host of the MTU of the new route. The IP message should be packaged with the minimum MTU of the route as much as possible. In this way, the segmentation is avoided and fewer messages are sent, improving the communication efficiency.

Relevant hosts must support the IP route MTU detection. They then can adjust the length of IP message according to the MTU value notified by the routing switch, preventing segmentation during the forwarding process.

5. Setting IP maximum transmission unit

All interfaces have a default IP maximum transmission unit (MTU), that is, the transmissible maximum IP message length. If the IP message length exceeds MTU, the routing switch segments the message. Changing the MTU value of the interface is to affect the IP MTU value. If IP MTU equals to MTU, IP MTU will automatically adjust itself to be the same as new MTU as MTU changes. The change of IP MTU, however, does not affect MTU. IP MTU cannot be bigger than MTU configured on the current interface. Only when all devices connecting the same physical media must have the same MTU protocol can normal communication be created.

To set IP MTU on special interface, run the following command in interface configuration mode:

Run...	To...
ip mtu bytes	Set IP MTU of the interface.

6. Authorizing IP source route

The routing switch checks the IP header of every message. The routing switch supports the IP header options defined by RFC 791: strict source route, relax source route, record route and time stamp. If the switch detects that an option is incorrectly selected, it will send message about the ICMP parameter problem to the source host and drop the message. If problems occur in the source route, the routing switch will send ICMP unreachable message (source route fails) to the source host.

IP permits the source host to specify the route of the IP network for the message. The specified route is called as the source route. You can specify it by selecting the source route in the IP header option. The routing switch has to forward the IP message according to the option, or drop the message according to security requirements. The routing switch then sends ICMP unreachable message to the source host. The routing switch supports the source route by default.

If the IP source route is disabled, run the following command in global configuration mode to authorize the IP source route:

Run...	To...

ip source-route	Authorizing IP source route.
-----------------	------------------------------

7. Allowing IP fast exchange

IP fast exchange uses the route cache to forward the IP message. Before the switch forwards message to a certain destination, its system will check the routing table and then forward the message according to a route. The selected route will be stored in the routing cache of the system software. If latter message will be sent to the same host, the switch will forward latter message according to the route stored in the routing cache. Each time message is forwarded, the value of hit times of the corresponding route item is increasing by 1. When the hit times is equal to the set value, the software routing cache will be stored in the hardware routing cache. The following message to the same host will be forwarded directly by the hardware. If the cache is not used for a period of time, it will be deleted. If the software/hardware cache items reach the upper limitation, new destination hosts are not stored in the cache any more. The managed switch can hold 2074 hardware cache items and 1024 software cache items. To allow or forbid fast exchange, run the following command in interface configuration mode:

Run...	To...
ip route-cache	Allow fast exchange (use the routing cache to forward the IP message).
no ip route-cache	Forbid fast exchange.

To configure the hit times required when the software cache items are stored to the hardware cache, run the following command in global configuration.

Run...	To...
ip route-cache hit-numbers <i>hitnumber</i>	When the hit times of the routing item in the software cache reaches the value of the parameter hitnumber , the routing item in the software cache will be stored as a routing item in the hardware cache.

8. Supporting IP fast exchange on the same interface

You can enable the switch to support IP fast exchange by making the receiving interface the same as the transmitting interface. Generally, it is recommended not to enable the function because it conflicts with the redirection function of the router.

Run the following command in interface configuration mode to allow IP routing cache in the same interface:

Run...	To...
ip route-cache same-interface	Allow IP message with the same receiving/transmitting interfaces to be stored in the routing cache.

43.4.1.2 Configuring Performance Parameters

1. Setting the wait time for TCP connection

When the routing switch performs TCP connection, it considers that the TCP connection fails if the TCP connection is not created during the wait time. The routing switch then notifies the upper-level program of the failed TCP connection. You can set the wait time for TCP connection. The default value of the system is 75 seconds. The previous configuration has no impact on TCP connections that the switch forwards. It only affects TCP connections that are created by the switch itself.

Run the following command in global configuration mode to set the wait time for TCP connections:

Run...	To...
<code>ip tcp synwait-time <i>seconds</i></code>	Set the wait time for TCP connection.

2. Setting the size of TCP windows

The default size of TCP windows is 2000 byte. Run the following command in global configuration mode to change the default window size:

Run...	To...
<code>ip tcp window-size <i>bytes</i></code>	Set the size of TCP windows.

43.4.1.3 Detecting and Maintaining IP Network

1. Clearing cache, list and database

You can clear all content in a cache, list or database. Incorrect data in a cache, list or database need be cleared.

Run the following command to clear incorrect data:

Run...	To...
<code>clear tcp statistics</code>	Clear TCP statistics data.

2. Clearing TCP connection

To disconnect a TCP connection, run the following command:

Run...	To...
<code>clear tcp {local host-name port remote host-name port tcb address}</code>	Clear the designated TCP connection. TCB refers to TCP control block.

3. Displaying statistics data about system and network

The system can display the content in the cache, list and database. These statistics data can help you know the usage of systematic sources and solve network problems.

Run the following commands in management mode. For details, refer to "IP Service Command".

Run...	To...
<code>show ip access-lists <i>name</i></code>	Display the content of one or all access lists.

show ip cache [prefix mask] [type number]	Display the routing cache that is used for fast IP message exchange.
show ip sockets	Display all socket information about the routing switch.
show ip traffic	Display statistics data about IP protocol.
show tcp	Display information about all TCP connection states.
show tcp brief	Briefly display information about TCP connection states.
show tcp statistics	Display TCP statistics data.
show tcp tcb	Display information about the designated TCP connection state.

4. Displaying debugging information

When problem occurs on the network, you can run **debug** to display the debugging information.

Run the following command in management mode. For details, refer to "IP Service Command".

Run...	To...
debug arp	Display the interaction information about ARP.
debug ip icmp	Display the interaction information about ICMP.
debug ip raw	Display the information about received/transmitted IP message.
debug ip packet	Display the interaction information about IP.
debug ip tcp	Display the interaction information about TCP.
debug ip udp	Display the interaction information about UDP.

43.4.2 Configuring Access List

43.4.2.1 Filtering IP Message

Filtering message helps control the movement of packet in the network. The control can limit network transmission and network usage through a certain user or device. To make packets valid or invalid through the crossly designated interface, our routing switch provides the access list. The access list can be used in the following modes:

Controlling packet transmission on the interface

Controlling virtual terminal line access

Limiting route update content

The section describes how to create IP access lists and how to use them.

The IP access list is an orderly set of the **permit/forbid** conditions for applying IP addresses. The ROS software of our switch tests the address one by one in the access list according to regulations. The first match determines whether the ROS accepts or declines the address. After the first match, the ROS software

terminates the match regulations. The order of the conditions is, therefore, important. If no regulations match, the address is declined.

Use the access list by following the following steps:

- (1) Create the access list by designating the access list name and conditions.
- (2) Apply the access list to the interface.

43.4.2.2 Creating Standard and Extensible IP Access List

Use a character string to create an IP access list.



The standard access list and the extensible access list cannot have the same name.

Run the following command in global configuration mode to create a standard access list:

Run...	To...
ip access-list standardname	Use a name to define a standard access list.
deny {source [source-mask] any }[log] or permit {source [source-mask] any }[log]	Designate one or multiple permit/deny conditions in standard access list configuration mode. The previous setting decides whether the packet is approved or disapproved.
Exit	Log out from the access list configuration mode.

Run the following command in global configuration mode to create an extensible access list.

Run...	To...
ip access-list extended name	Use a name to define an extensible IP access list.
{ deny permit } protocolsource source-mask destination destination-mask [precedenceprecedence] [tos tos] [established] [log]{ deny permit } protocolany any	Designate one or multiple permit/deny conditions in extensible access list configuration mode. The previous setting decides whether the packet is approved or disapproved. precedence means the priority of the IP packet; TOS means Type of Service.
Exit	Log out from the access list configuration mode.

After the access list is originally created, any part that is added later can be put at the end of the list. That is to

say, you cannot add the command line to the designated access list. However, you can run **no permit** and **no deny** to delete items from the access list.



When you create the access list, the end of the access list includes the implicit deny sentence by default. If the mask is omitted in the relative IP host address access list, 255.255.255.255 is supposed to be the mask.

After the access list is created, the access list must be applied on the route or interface. For details, refer to section 4.2.3 “Applying the Access List to the Interface”.

43.4.2.3 Applying the Access List to the Interface

After the access list is created, you can apply it to one or multiple interfaces including the **in** interfaces and **out** interfaces.

Run the following command in interface configuration mode.

Run...	To...
ip access-groupname {in out}	Apply the access list to the interface.

The access list can be used on the **in** interfaces and the **out** interfaces. For the standard access list of the **in** interface, the source address of the packet is to be checked according to the access list after the packet is received. For the extensible access list, the routing switch also checks the destination. If the access list permits the address, the software goes on processing the packet. If the access list does not permit the address, the software drops the packet and returns an ICMP unreachable message.

For the standard access list of the **out** interfaces, after a packet is received or routed to the control interface, the software checks the source address of the packet according to the access list. For the extensible access list, the routing switch also checks the access list of the receiving side. If the access list permits the address, the software will send the packet. If the access list does not permit the address, the software drops the packet and returns an ICMP unreachable message.

If the designated access list does not exist, all packets allow to pass.

43.4.2.4 Extensible Access List Example

In the following example, the first line allows any new TCP to connect the destination port after port 1023. The second line allows any new TCP to connect the SMTP port of host 130.2.1.2.

```
ip access-list extended aaa
permit tcp any 130.2.0.0 255.255.0.0 gt 1023
permit tcp any 130.2.1.2 255.255.255.255 eq 25
interface vlan 10
ip access-group aaa in
```

Another example to apply the extensible access list is given. Suppose a network connects the Internet, you expect any host in the Ethernet can create TCP connection with the host in the Internet. However, you expect the host in the Internet cannot create TCP connection with the host in the Ethernet unless it connects the SMTP port of the mail host.

During the connection period, the same two port numbers are used. The mail packet from the Internet has a destination port, that is, port 25. The outgoing packet has a contrary port number. In fact, the security system behind the routing switch always receives mails from port 25. That is the exact reason why the incoming service and the outgoing service can be uniquely controlled. The access list can be configured as the outgoing service or the incoming service.

In the following case, the Ethernet is a B-type network with the address 130.20.0.0. The address of the mail host is 130.20.1.2. The keyword **established** is only used for the TCP protocol, meaning a connection is created. If TCP data has the ACK or RST digit to be set, the match occurs, meaning that the packet belongs to an existing connection.

```
ip access-list aaa
permit tcp any 130.20.0.0 255.255.0.0 established
permit tcp any 130.20.1.2 255.255.255.255 eq 25
interface vlan 10
ip access-group aaa in
```

43.4.3 Configuring IP Access List Based on Physical Port

43.4.3.1 Filtering IP Message

43.4.3.2 Filtering IP Message

Filtering message helps control the movement of packet in the network. The control can limit network transmission and network usage through a certain user or device. To make packets valid or invalid through the crossly designated interface, our routing switch provides the access list. The access list can be used in the following modes:

Controlling packet transmission on the interface

Controlling virtual terminal line access

Limiting route update content

The section describes how to create IP access lists and how to use them.

The IP access list is an orderly set of the **permit/forbid** conditions for applying IP addresses. The ROS software of our switch tests the address one by one in the access list according to regulations. The first match determines whether the ROS accepts or declines the address. After the first match, the ROS software terminates the match regulations. The order of the conditions is, therefore, important. If no regulations match, the address is declined.

Use the access list by following the following steps:

- (1) Create the access list by designating the access list name and conditions.
- (2) Apply the access list to the interface.

43.4.3.3 Creating Standard and Extensible IP Access List

Use a character string to create an IP access list.



The standard access list and the extensible access list cannot have the same name.

Run the following command in global configuration mode to create a standard access list:

Run...	To...
ip access-list standard <i>name</i>	Use a name to define a standard access list.
deny { <i>source [source-mask] any</i> }[log] or permit { <i>source [source-mask] any</i> }[log]	Designate one or multiple permit/deny conditions in standard access list configuration mode. The previous setting decides whether the packet is approved or disapproved.
Exit	Log out from the access list configuration mode.

Run the following command in global configuration mode to create an extensible access list.

Run...	To...
ip access-list extended <i>name</i>	Use a name to define an extensible IP access list.
{ deny permit } <i>protocol</i> <i>source</i> <i>source-mask</i> <i>destination</i> <i>destination-mask</i> [precedence <i>precedence</i>] [tos <i>tos</i>] [established] [log]{ deny permit } <i>protocol</i> any any	Designate one or multiple permit/deny conditions in extensible access list configuration mode. The previous setting decides whether the packet is approved or disapproved. precedence means the priority of the IP packet; TOS means Type of Service.
Exit	Log out from the access list configuration mode.

After the access list is originally created, any part that is added later can be put at the end of the list. That is to say, you cannot add the command line to the designated access list. However, you can run **no permit** and **no deny** to delete items from the access list.



When you create the access list, the end of the access list includes the implicit **deny** sentence by default. If the mask is omitted in the relative IP host address access list, 255.255.255.255 is supposed to be the mask.

After the access list is created, the access list must be applied on the route or interface. For details, refer to section 4.2.3 "Applying the Access List to the Interface".

43.4.3.4 Applying the Access List to the Interface

After the access list is created, you can apply it to one or multiple interfaces including the **in** interfaces and **out** interfaces.

Run the following command in interface configuration mode.

Run...	To...
ip access-groupname {in out}	Apply the access list to the interface.

The access list can be used on the **in** interfaces and the **out** interfaces. For the standard access list of the **in** interface, the source address of the packet is to be checked according to the access list after the packet is received. For the extensible access list, the routing switch also checks the destination. If the access list permits the address, the software goes on processing the packet. If the access list does not permit the address, the software drops the packet and returns an ICMP unreachable message.

For the standard access list of the **out** interfaces, after a packet is received or routed to the control interface, the software checks the source address of the packet according to the access list. For the extensible access list, the routing switch also checks the access list of the receiving side. If the access list permits the address, the software will send the packet. If the access list does not permit the address, the software drops the packet and returns an ICMP unreachable message.

If the designated access list does not exist, all packets allow to pass.

43.4.3.5 Extensible Access List Example

1. Port-based IP access list supporting TCP/UDP port filtration

{deny | permit} {tcp | udp}

source *source-mask* [{ [src_portrange begin-port end-port] | [{gt | lt } port] }]

destination *destination-mask* [{ [dst_portrange begin-port end-port] | [{gt | lt } port] }]

[**precedence***precedence*] [**tos***tos*]

If you configure the access list by defining the port range, pay attention to the following:

- If you use the method of designating the port range to configure the access list at the source side and the destination side, some configuration may fail because of massive resource consumption. In this case, you need to use the fashion of designating the port range at one side, and use the fashion of designating the port at another side.
- When the port range filtration is performed, too many resources will be occupied. If the port range filtration is used too much, the access list cannot support other programs as well as before.

2. Port-based IP access list supporting TCP/UDP designated port filtration

In the following example, the first line allows any new TCP to connect the SMTP port of host 130.2.1.2.

```
ip access-list extended aaa
permit tcp any 130.2.1.2 255.255.255.255 eq 25
interface f0/10
ip access-group aaa
```

Chapter 44. IP ACL Application Configuration

44.1 Applying the IP Access Control List

44.1.1 Applying ACL on Ports

After an ACL is established, it can be applied on one or many slots or globally.

Run the following command in global or port configuration mode:

Command	Purpose
config	Enters the global configuration mode.
interface g0/1	Enters the to-be-configured port.
[no] {ip ipv6} access-groupname [egress vlan {word add word remove word}]	Applies the established IP/IPv6 access list to an interface or cancels it on the interface. Egress means that the ACL is applied in an outbound direction. Vlan means that the ACL is applied in an inbound VLAN. Word stands for the VLAN range table. Add means to add the VLAN range table. Remove means to delete the VLAN range table.
exit	Goes back to the global configuration mode.
exit	Goes back to the EXEC mode.
write	Saves the settings.

Chapter 45. Routing Configuration

45.1 Configuring RIP

45.1.1 Overview

The section describes how to configure the RIP. For details about RIP commands, refer to the section “RIP Commands” in “Network Protocol Command Reference”.

The routing information protocol (RIP) is still a commonly used interior gateway protocol (IGP), mainly applied to small-scale networks of the same type. RIP is a classical distance vector routing protocol, which appears in RFC 1058.

RIP uses the broadcast of the UDP packet to exchange the routing information. In the routing switch, the update of the routing information is performed every 30 seconds. If a switch does not receive the update information from the neighboring switches in 180 seconds, the switch is to label the route in the routing table from the neighboring switch as “unavailable”. If the update information is still not received in the following 120 seconds, the switch will delete the route from the routing table.

RIP uses the hop count to balance the weight of different routes. The hop count is the number of switches that a packet gets through from the information source and the information sink. The routing weight of the directly-connected network is **0**. The routing weight of the unreachable network is **16**. Because the range of RIP-using routing weight is small, it is not suitable for the large-scale network.

If the switch has a default route, the RIP declares the route to the pseudo-network 0.0.0.0. In fact, network 0.0.0.0 does not exist. It is just used in RIP to realize the default route. If RIP learns a default route, or the default gateway and the default weight are configured in a switch, the switch is to declare the default network. RIP sends the routing update information to the designated network interface. If the network that the interface resides is not designated, the network cannot be declared in any RIP update information.

The RIP-2 of our switches supports plain text, MD5 authentication, routing summary, CIDR and VLSM.

45.1.2 Configuring RIP Task List

To configure RIP, the following tasks must be complete first. The task to activate RIP is mandatory, while other tasks are optional.

- Starting up RIP
- Allowing RIP routing to update the single program broadcast
- Applying the offset to the routing weight
- Adjusting the timer
- Specifying the RIP version number
- Activating RIP authentication
- Forbidding routing summary
- Forbidding the authentication of the source IP address
- Configuring the maximum number of routes

- Activating or forbidding horizon split.
- Monitoring and maintaining RIP

45.1.3 Configuring RIP Tasks

45.1.3.1 Starting up RIP

Run the following command in global configuration mode to activate RIP:

Command	Purpose
routerrip	Activates the RIP routing process and enters the switch configuration mode.
network <i>network-number</i> <network-mask>	Specifies the network number related to the RIP routing process.

45.1.3.2 Allowing RIP Routing to Update the Single-Program Broadcast

Normally, RIP is a broadcast protocol. To enable the RIP routing update to reach the non-broadcast network, you must configure the switch to enable it to exchange the routing information.

Run the following command in switch configuration mode to enable the routing information exchange:

Command	Purpose
neighbor <i>ip-address</i>	Defines a neighboring switch to exchange routing information with the known switch.

Additionally, you can run **ip rip passive** to specify ports to forbid sending the route update information.

45.1.3.3 Applying the Offset to the Routing Weight

The offset list is used to add an offset for the outgoing routes or the incoming routes learned by the RIP. It provides a local mechanism to add the routing weight. You also can use the access list or the interface to limit the offset list. Run the following command in switch configuration mode to add the routing weight.

Command	Purpose
offset { [interface-type number]* } {in out} access-list-name offset	Adds an offset for the routing weight.

45.1.3.4 Adjusting the Timer

The routing protocol uses several timers to judge the frequency of sending route update information, how much time is needed for the route to become ineffective and other parameters. You can adjust these timers to improve the performance of the routing protocol.

You also can adjust the routing protocol to speed up the convergent time of all IP routing arithmetic, rapidly backing up the redundancy switch and ensuring the minimum breakdown time in case of quick recovery.

Run the following command in switch configuration mode to adjust the timer:

Command	Purpose
---------	---------

timers holddown value	It means how much time is needed for a route to be deleted from the routing table.
timers expirevalue	It means what interval is needed for a route to be declared ineffective.
timers updatevalue	It means the transmission frequency of the routing update information.

45.1.3.5 Specifying the RIP Version Number

The RIP-2 of our switches supports authentication, PIN management, routing summary, CIDR and VLSM. By default, the switch receives RIP-1 and RIP-2, but the switch only sends RIP-1. Through configuration, the switch can receive and send only the packet RIP-1, or only the packet RIP-2. To meet the previous demand, run the following command in switch configuration mode:

Command	Purpose
version {1 2}	The switch sends and receives only RIP-1 or only RIP-2.

The previous tasks control the default actions of the RIP. You also can configure a certain interface to change the default actions.

Run the following commands in VLAN configuration mode to control the interface whether to send RIP-1 or RIP-2.

Command	Purpose
ip rip send version 1	The configured interface only sends RIP-1.
ip rip send version 2	The configured interface only sends RIP-2.
ip rip send versioncompatibility	Sends the RIP-2 update message in the form of broadcast.

Run the following commands in interface configuration mode to control the interface whether to receive packet RIP-1 or packet RIP-2

Command	Purpose
ip rip receive version 1	The configured interface only receives RIP-1.
ip rip receive version 2	The configured interface only receives RIP-2.
ip rip receive version 1 2	The configured interface receives RIP-1 and RIP-2.

45.1.3.6 Activating RIP Authentication

RIP-1 does not support authentication. To receive and send the RIP-2 packet, you can activate the RIP authentication on the interface.

On the activated interface, two authentication modes are provided: plain text authentication and MD5

authentication. Each RIP-2 packet uses the plain authentication by default.



For the purpose of security, do not use the plain authentication in the RIP packet because the unencrypted authentication PIN is sent to each RIP-2 packet. You can use the plain authentication without security concern.

Run the following commands in VLAN configuration mode to configure the RIP plain text authentication.

Command	Purpose
ip rip authentication simple	Configures the interface to use the plain authentication.
ip rip password [string]	Configures the PIN of the plain authentication.

Run the following commands in interface configuration mode to configure the MD5 authentication of the RIP:

Command	Purpose
ip rip authentication message-digest	Configures the interface to use the MD5 authentication.
ip rip message-digest-key [key-ID] md5 [key]	Configures the PIN and ID of the md5 authentication.

45.1.3.7 Forbidding Routing summary

RIP-2 supports the automatic routing summary by default. RIP-2 routes are collected when passing the boundaries of different networks. The RIP-1 automatic collection function is always in **positive** state.

If there is a separated subnet, you need to forbid the routing summary function to declare the subnet. If the routing summary function is disabled, the switch is to send the routing information of the subnet and the host when passing through the boundaries of different networks. Run the following command in switch configuration mode to disable the automatic routing summary function.

Command	Purpose
no auto-summary	Disables the automatic routing summary function.

45.1.3.8 Forbidding the Authentication of the Source IP Address

By default, the switch authenticates the source IP address in the RIP routing update information. If the address is illegal, the routing update is dropped.

When a switch wants to receive its own update information and the network and neighbor are not configured on the switch of the receiving side, you can forbid the authentication of the source IP address. Normally, you are not recommended to use the command. Run the following command in switch configuration mode to forbid authenticating the source IP address of the incoming routing information:

Command	Purpose
---------	---------

no validate-update-source	Forbids authenticating the source IP address of the incoming routing information.
----------------------------------	---

45.1.3.9 Configuring the Maximum Number of Routes

By default, the local RIP routing table contains up to 1024 routes. When the route number exceeds the maximum number, you cannot add new routes to the routing table. At the same time, the system notifies you that the route number has already reached the maximum number set for the routing table. Run the following command in switch configuration mode to configure the maximum number of routes for the local RIP routing table:

Command	Purpose
maximum-count <i>number</i>	Configures the maximum number of routes for the local RIP routing table.
no maximum-count	Resumes the default maximum number of routes.

45.1.3.10 Activating or Forbidding Horizon Split

Normally, the switch that connects to the broadcast IP network and adopts the distance vector routing protocol adopts the horizon split to reduce the possibility of the routing loop. The information about the routing loop of horizon split declares itself to the interface that receives the routing information. In this way, the communication among multiple routing switches is improved, especially when the loop breaks. However, it is not so good as to the non-broadcast network. At this time, you may forbid the horizon split.

If the assistant IP address is configured on the interface and the horizon split is activated, the source IP address of the routing update may not conclude all assistant addresses. The source IP address of one routing update contains only one network number.

Run the following commands in VLAN configuration mode to activate or forbid the horizon split.

Command	Purpose
ip rip split-horizon	Activates the horizon split.
no ip rip split-horizon	Forbids the horizon split.

By default, the horizon split is activated on the point-to-point interface; the point-to-multiple interface is forbidden.

For details, refer to the section "Horizon Split Example".



In normal case, do not change the default configuration unless you are sure that the programs need to change states. Remember that if the horizon split is forbidden in a serial port that connects a packet switching network, you must forbid the horizon split in the switches in relative multiple-program group of a network.

45.1.3.11 Monitoring and Maintaining RIP

Monitoring and maintaining RIP needs to display network statistics information, such as RIP parameter configuration, real-time network track. These information help you judge the network usage, solve network problem and the reachability of network nodes.

Run the following commands in management mode to display all routing statistics information:

Command	Purpose
show ip rip	Display the current state of the RIP protocol.
show ip rip database	Displays all RIP routes.
show ip rip protocol	Displays all RIP-relative information.

Run the following commands in management mode to track routing protocol information:

Command	Purpose
debug ip rip database	Tracks information about adding RIP route to the routing table, deleting route from the routing table and changing route.
debug ip rip protocol	Tracks RIP message.

45.1.4 RIP Configuration Example

Device A and device B are configured as follows:

Device A:

```
interface vlan 11
ip address 192.168.20.81 255.255.255.0
!
interface loopback 0
ip address 10.1.1.1 255.0.0.0
!
router rip
network 192.168.20.0
network 10.0.0.0
!
```

Device B:

```
interface vlan 11
ip address 192.168.20.82 255.255.255.0
interface loopback 0
ip address 20.1.1.1 255.0.0.0
!
```



```
router rip
network 192.168.20.0
network 20.0.0.0
!
```

45.2 Configuring BEIGRP

45.2.1 Overview

Technologies used by BEIGRP are similar to the distance vector protocol:

- The router makes routing decision according to the information provided by the directly-connecting neighbor;
- The router provides its routing information to its directly-connecting neighbor. However, BEIGRP has more advantages compared with the distance vector protocol:
- BEIGRP saves all routes sent by all neighbors in the topology, not just saving the best route received up to now.
- BEIGRP can query neighbors when it cannot access the destination and has no replaceable route. Therefore, the convergence speed of BEIGRP is as fast as that of the best-link-state protocol.

Diffused Update Algorithm (DUAL) of BEIGRP is the core reason why BEIGRP is better than other traditional distance vector protocols. It always in **active** state and queries the neighbors when it cannot access the destination and there is no replaceable route. Therefore, the collection speed of BEIGRP is rapid.

BEIGRP is a special transmission protocol designed on the basis of EIGRP requirements. BEIGRP is created on the IP protocol. The following requirements are satisfied by BEIGRP:

- The disappearance of new or old neighbors is dynamically detected through the hello message.
- All data transmission is reliable.
- The transmission protocol allows the single-program or multiple-program transmission.
- The transmission protocol can adapt to the change of network conditions and neighbor response.
- BEIGRP can limit its bandwidth occupancy rate according to requirements.

45.2.2 BEIGRP Configuration Task List

The BEIGRP configuration includes the following tasks. Among the tasks, the task to activate the BEIGRP is mandatory; other tasks can be selectively performed according to requirements.

- Activating BEIGRP
- Configuring bandwidth occupancy percent
- Regulating account coefficient of BEIGRP compound distance
- Regulating the compound distance through offset
- Disabling automatic route summary
- Customizing route summary

- Configuring forwarding route
- Configuring other BEIGRP parameters
- Monitoring and maintaining the running of BEIGRP

45.2.3 BEIGRP Configuration Task

45.2.3.1 Activating BEIGRP

Perform the following operations to create a BEIGRP process:

Command	Purpose
router beigrpas-number	Adds a BEIGRP process in global configuration mode.
networknetwork-number network-mask	Adds network segment to the BEIGRP process in route configuration mode.

After the above configuration is complete, BEIGRP starts to run on all interfaces of the network segment. BEIGRP finds new neighbors through hello message and interacts original routes through update information.

45.2.3.2 Configuring Bandwidth Occupancy Percent

In default state, BEIGRP occupies up to 50% of bandwidth. You can run the following command in VLAN interface configuration mode to adjust the bandwidth that can be used by BEIGRP.

Command	Purpose
ip beigrp bandwidth-percentpercent	Configures the maximum bandwidth percent for the BEIGRP message.

45.2.3.3 Regulating Coefficient of BEIGRP Compound Distance

In some cases, the coefficient of BEIGRP compound distance need be regulated, which finally affects the routing strategy. Though the default coefficient used by BEIGRP is suitable for most network conditions, you need to regulate it in some special cases. The regulation may cause great change of the whole network. Be careful when you perform this regulation.

Run the following command in route configuration mode:

Command	Purpose
metric weightsk1 k2 k3 k4 k5	Regulates the coefficient of the BEIGRP compound distance.

45.2.3.4 Regulating the Compound Distance Through Offset

You can add all incoming and outgoing routes purposively according to requirements using the offset table, or add compound distances of several suitable routes. The purpose is to affect the routing result of the router. In the configuration process, you can selectively specify the access list or the application interface in the offset list to further confirm routes which the offset is added to.

Command	Purpose
---------	---------

offset {type number *} {in out} access-list-name offset	Applies a offset table.
---	-------------------------

45.2.3.5 Disabling Automatic Route summary

The automatic collection of BEIGRP is different from that of other dynamic routing protocols. It complies with the following regulations:

- When multiple networks in a BEIGRP process are defined, a summary route of the defined network is generated if at least one subnet of the network is in the BEIGRP topology table.
- The created summary route is oriented to the Null0 interface has the minimum distance of all subnets. The summary route is also added to the main IP routing table. Its management distance is 5 (which cannot be configured).
- When the update information is sent to neighbors in different main IP networks, the subnet of the summary route of rule 1 and rule 2 is canceled. Only the summary route is sent.
- Subnets that do not belong to any network defined in the BEIGRP procedure are not be collected.

In some network conditions, you may hope to notify neighbors of each detailed route. In this case, you need run the following command:

Command	Purpose
no auto-summary	Disables the automatic routing summary.

45.2.3.6 Customizing Routing summary

When the automatic routing summary cannot meet the requirements, you can configure routing summary on every interface where BEIGRP runs, and specify the destination network segments that are to perform routing summary. The interfaces where routing summary is configured will not send any detailed routing update information that belongs to the routing summary network segment. Other interfaces do not get affected.

The routing summary operations comply with the following regulations:

- After a routing summary command is configured on an interface, a summary route of the defined network is generated if at least one subnet of the network is in the BEIGRP topology table.
- The created summary route is oriented to the Null0 interface has the minimum distance of all subnets. The summary route is also added to the main IP routing table. Its management distance is 5 (which cannot be configured).
- When the routing update information is sent on the interface where routing summary is configured, the detailed routes belonging to routing summary network segment are to cancelled. Other routing update information will not be affected.

Command	Purpose
ip beigrp summary-address <i>ip address address mask</i>	Configures routing summary on the interface.

45.2.3.7 Configuring Forwarding Route

When BEIGRP forwards other types of routes, BEIGRP complies with the following regulations:

- If the present route is static or directly-connected, the command **default-metric** need not be configured and other compound distance parameters (bandwidth, delay, reliability, effective load and MTU) are directly obtained from the current port.
- If the present routes are routes of other BEIGRP processes, the **default-metric** command need not be configured and its compound distance parameters are directly obtained from the BEIGRP process.
- The **default-metric** command must be configured when routes of other protocols such as rip and ospf are sent. The suitable distance of the route forwarding is determined by the configuration value. If the command is not configured, the route forwarding cannot function.

On the switch where BEIGRP and RIP simultaneously run, to make BEIGRP neighbors learn the routes learned by the RIP protocol in the local switch, run the following command.

Command	Purpose
default-metric bandwidth delay reliability loading mtu	Configures the default vector distance for route forwarding.
redistribute <i>protocol</i> [route-map <i>name</i>]	Forwards routes to the BEIGRP protocol.

45.2.3.8 Configuring Other BEIGRP Parameters

To adjust to different network conditions and make BEIGRP more efficient, you need modify the following parameters:

- Modify the interval for BEIGRP to send hello message and neighbor timeout time.
- Disable the horizon split.

45.2.3.8.1 Modify the interval for BEIGRP to send hello message and neighbor timeout time

The following objectives needed by the BEIGRP hello protocol to perform correct BEIGRP operations are listed:

- It can find new accessible neighbor. The detection of neighbor is an automatic process without any manual configuration.
- It authenticates neighbor configuration and only allows communication between neighbors that are configured in compatible mode.
- It continuously monitors neighbor's usability and detects the disappearance of neighbors.

The router sends the hello multiple-program broadcast packet on the interfaces where BEIGRP runs. Each BEIGRP-supporting router receives these multiple-program broadcast packets. Therefore, all neighbors can be found.

The Hello protocol uses two timers to detect the disappearance of neighbors. The hello interval specifies the

transmission frequency of the BEIGRP hello message on the interface of the router. **hold timer** specifies the time to declare the neighbor is dead when the router cannot receives data from the designated neighbor. After any type of the BEIGRP packet is received from the neighboring router, the value of **hold timer** needs to be reset.

Different network types or network bandwidth adopt different default values of the hello timer.

Interface Type Packaging		Hello Timer (second)	Hold Timer (second)
LAN Interface	Any	5	15

In the Hello protocol, different default values of the timer may cause BEIGRP neighbors that connect the same IP subnet to use different hello timers or hold timers. To prevent the problem from occurring, you need to specify the hold timer in the hello packet of each router. Each BEIGRP router uses the hold timer specified in the hello packet of the neighboring router to judge whether the neighbor times out. In this way, trouble-detecting timers of different neighbors appears in one WAN topology. In special cases, the default value of the timer cannot fulfill actual requirements. To modify the interval to send the hello message, run the following command:

Command	Purpose
ip beigrp hello-intervalseconds	Modifies the interval to send the hello message on the interface.

To modify the timeout timer of the neighbor, run the following command:

Command	Purpose
ip beigrp hold-timesseconds	Modifies the timeout time of the neighbor.

45.2.3.8.2 Disabling the horizon split

The horizon split function is normally adopted. It prevents a received routing information from broadcasting out from the same interface, avoiding route loop. In some cases, the horizon split function is not the best choice, so you can run the following command to disable the horizon split function:

Command	Purpose
no ip beigrp split-horizon	Disables the horizon split function.

45.2.3.9 Monitoring and Maintaining BEIGRP

Run the following command to clear the neighboring relationship.

Command	Purpose
clear ip beigrp neighbors [interface]	Clear the neighboring relationship.

Run the following commands to display all BEIGRP statistics information:

Command	Purpose
show ip beigrp interfaces [interface]	Displays the information about BEIGRP

<i>[as-number]</i>	interface.
show ip beigrp neighbors <i>[as-number interface]</i>	Displays the information about BEIGRP neighbors.
show ip beigrp topology <i>[as-number all-link summary active]</i>	Displays the information about BEIGRP topology table.

45.2.4 BEIGRP Configuration Example

In the following example, the summary route that sends network segment 10.0.0.0/8 on VLAN11 is configured. All subnet routs of the network segment will not be notified of the neighbor. At the same time, the automatic summary of the BEIGRP process is disabled.

```
interface vlan 11
ip beigrp summary-address 1 10.0.0.0 255.0.0.0
!
router beigrp 1
network 172.16.0.0 255.255.0.0
no auto-summary
```

45.3 Configuring OSPF

45.3.1 Overview

The chapter describes how to configure the OSPF. For the details of OSPF commands, refer to relative sections about OSPF commands.

OSPF is a IGP routing protocol developed by the OSPF team of IETF. OSPF designed for the IP network supports IP subnets and exterior routing information identifier, message authentication and IP multicast. The OSPF function of our switches complies with the requirements of OSPF V2 (See RFC2328). The following table lists some key features in reality.

Key Feature	Description
Stub domain	Support the stub domain.
Rout forwarding	Routes that are learned by any routing protocol can be forwarded to other routing protocol domain, which means that OSPF can enter routes that RIP learned in the automatic domain. The routes that OSPF learns also can be exported to RIP. Among the automatic domains, OSPF can enter the routes that BGP learns; OSPF routes also can be exported to BGP.
Authentication	Among neighboring switches in a domain, the plain text and MD5 authentication are supported.
Routing interface	The configurable interface parameters include the output

parameters	cost, resending interval, interface output delay, the priority of the switch, the interval to judge the shutdown of the switch, the interval of the hello packet and the authentication PIN.
Virtual link	The virtual link is supported.
NSSA area	See RFC 1587.
OSPF in the on-demand circuit	See RFC 1793.

45.3.2 OSPF Configuration Task List

OSPF requires the routing data exchange among switches, ABR and ASBR in the whole domain. To simplify the configuration, you can make them run in the default settings without authentication. However, if you modify a certain parameter, make sure that the modified parameter is the same on all switches.

You need to complete the following tasks to configure OSPF. The task to activate OSPF is mandatory, while other configurations are optional.

- Starting up OSPF
- Configuring interface parameters of OSPF
- Configuring OSPF in different physical networks
- Configuring OSPF area parameters
- Configuring NSSA domain of OSPF
- Configuring routing summary in the OSPF area
- Configuring forwarded routing summary
- Generating default route
- Choosing route ID on the LOOPBACK interface
- Configuring the management distance of OSPF
- Configuring timer for route calculation
- Monitoring and maintaining OSPF

For route forwarding configuration, refer to relevant content about the IP routing protocol configuration

45.3.3 OSPF Configuration Task

45.3.3.1 Starting up OSPF

Similar to other routing protocols, before activating OSPF, you have to create the OSPF routing process. In the creation of the routing process, An IP address range related to the processing and a relevant domain ID need be distributed.

Run the following commands in global configuration mode to start up OSPF:

Command	Purpose
router ospf <i>process-id</i>	Activates the OSPF routing protocol and enters the switch configuration mode.
network <i>addressmaskareaarea-id</i>	Configures the running interface of OSPF

	and the relevant interface domain ID.
--	---------------------------------------

45.3.3.2 Configuring Interface Parameters of OSPF

You are allowed to modify OSPF parameters of the interface according to actual requirements. When you modify a parameter, make sure that the parameter on all switches of the interconnected network is same.

Run the following commands in interface configuration mode to configure the interface parameters:

Command	Purpose
ip ospf cost <i>cost</i>	Configures the value of the transmission packet on the OSPF interface.
ip ospf retransmit-interval <i>seconds</i>	Configures the seconds of LSA resending between neighbors on the same OSPF interface.
ip ospf transmit-delay <i>seconds</i>	Configures the time to send LSA on an OSPF interface (unit: second).
ip ospf priority <i>number</i>	Configures the priority number for the routing switch to become the OSPF DR routing switch.
ip ospf hello-interval <i>seconds</i>	Configures the interval to send the hello packet on the OSPF interface.
ip ospf dead-interval <i>seconds</i>	Configures the dead interval. In the prescribed interval, if the hello packet from neighbors is not received, the neighboring switch is considered to be in shutdown state.
ip ospf authentication-key <i>key</i>	Represents the authentication password of the neighboring route in a network segment. The OSPF authentication password is adopted.
ip ospf message-digest-key <i>keyid</i> <i>md5 key</i>	Requires OSPF to use the MD5 authentication.
ip ospf passive	Configures the state of the hello message on a port.

45.3.3.3 Configuring OSPF in Different Physical Networks

OSPF divides the physical media of the network into the following classes:

- Broadcast network (Ethernet, Token Ring, FDDI)
- Non-broadcast and multi-access network (SMDS, Frame Relay, X.25)
- Point-to-point network (HDLC, PPP)

The X.25 and frame-relay network provides optional broadcast capability. You can configure the OSPF to run

in the broadcast network through the **map** command. For details of the map command, refer to the description of the map command in *WAN Command Reference*.

45.3.3.4 Configuring OSPF Network Type

No matter what physical media type your network belongs to, you can configure your network to be the broadcast network or the non-broadcast and multi-access network. This feature allows you configure the network flexibly. You can configure the broadcast network to the non-broadcast and multi-access network; you also can configure the non-broadcast network, such as X.25, Frame Relay and SMDS, to the broadcast network. The feature also eases the neighbor's configuration. For details, refer to contents about OSPF configuration of non-broadcast network.

Configuring the non-broadcast and multi-access network to a broadcast network or a non-broadcast network is to suppose that the virtual link exists between two random switches or to suppose that the network is a mesh network. The previous configuration is unreal because it costs too much. You may configure the non-broadcast and multi-access network to a partly meshed network. To save the expense, you can configure the non-broadcast and multi-access network to a point-to-multipoint network. The disconnected switches can exchange the routing information with each other through the virtual link.

The interface connecting the OSPF point to other points is defined as the point-to-multipoint network interface. It creates lots of host routes. Comparing with the non-broadcast and multi-access network or the point-to-point network, the OSPF point-to-multipoint network has the following advantages:

- The point-to-multipoint network is easy to configure. The configuration does not need the neighbor configuration commands. It only needs an IP address and there is no DR.
- The point-to-multipoint network does not need the wholly meshed network's topology, so the expense is smaller.
- It is more reliable. The connection can keep working even if the virtual link fails.

Run the following commands in interface configuration mode to configure the type of the OSPF network.

Command	Purpose
ip ospf network {broadcast non-broadcast {point-to-multipoint [non-broadcast] }}	Configures the network type of the OSPF.

The network of the switch is a broadcast network.

45.3.3.5 Configuring OSPF Area Parameters

The configurable area parameters include authentication, stub area and the value of the default routing summary. The authentication is based on the password protection.

Stub area is an area which exterior routes are not sent to. ABR generates a default exterior route to enter the stub area, enabling stub area to connect exterior networks out of the automatic area. To utilize the feature that OSPF stub supports, the default route must be used in the stub area. To further reduce the LSAs to enter the stub area, you need select the option **No Summary** in the ABR.

Run the following command in switch configuration mode to set area parameters:

Command	Purpose
area area-id authentication simple	Activates the authentication of the OSPF area.
area area-id authentication message-digest	Specifies the MD5 authentication as the authentication OSPF.
area area-id stub [no-summary]	Defines a stub area.
area area-id default-cost cost	Set the value of the default route in the stub area.

45.3.3.6 Configuring Routing Summary in the OSPF Area

The feature enables the ABR to broadcast a summary route to other areas. In OSPF, ABR is to broadcast every network to other areas. If the network number is distributed serially according to some method, you can configure ABR to broadcast a summary route to other areas. The summary route can cover all networks in a certain range.

Run the following command in switch configuration mode to set the address range:

Command	Purpose
area area-id range address mask	Sets the address range of the summary area.

45.3.3.7 Configuring Forwarded Routing Summary

When the routes are distributed from other areas to the OSPF area, each route will be uniquely broadcast in the exterior LSA method. However, you can configure the switch to broadcast a route, which can cover a certain address area. This method reduces the size of the OSPF link state database.

Run the following command in switch configuration mode to configure the summary route:

Command	Purpose
summary-address prefix mask [not advertise]	Describes the address and mask covering the distributed route. Only one summary route is broadcast.

45.3.3.8 Generating Default Route

ASBR requires generating a default route to enter the OSPF route area. When you configure the switch to distribute the route to the OSPF area, the route automatically becomes ASBR. However, default ASBR does not generate the default route to enter the OSPF routing area.

Run the following command in switch configuration mode to force ASBR to generate the default route.

Command	Purpose
default-information originate [always] [route-map map-name]	Forces ASBR to generate the default route.

45.3.3.9 Choosing Route ID Through the LOOPBACK Interface

OSPF takes the maximum IP address configured on the interface as the switch ID. If the interface connecting the IP address changes to the Down state, or the IP address is cancelled, the OSPF process is to recalculate the new switch ID and resend the routing information from all interfaces.

If a **loopback** interface is configured with the IP address, the switch takes its IP address as its ID. The **loopback** interface will never be at the **down** state. Therefore, the routing table is stable.

The switch preferentially takes the **loopback** interface as the switch ID. It also chooses the maximum IP address as the switch ID. If the loopback interface does not exist, the maximum IP address of the switch is taken as the switch ID. You cannot specify OSPF to use any special interface.

Run the following command in global configuration mode to configure the IP loopback interface:

Command	Purpose
interface loopback 0	Creates a loopback interface and enters the interface configuration mode.
ip address <i>ip-address mask</i>	Distributes an IP address for an interface.

45.3.3.10 Configuring OSPF Management Distance

The management distance stands for the credit level of the routing information source, such as the single switch or a group of switches. Generally, the management distance is an integer between 0 and 255. The bigger the number is, the lower the credit level is. If the management distance is 255, the routing information source is not trusted or should be omitted.

OSPF uses three kinds of different management distances: intra-area, inter-area and external. The routes in an area are called **intra-area** routes; routes to other areas are called **inter-area** routes; routes that are distributed from other routing protocol areas are called **external** routes. The default value of each type of routes is 110.

Run the following command in switch configuration mode to configure the distance vale of OSPF.

Command	Purpose
distance ospf [<i>intra-area dist1</i>] [<i>inter-area dist2</i>] [<i>external dist3</i>]	Modifies the management distance value of the intra-area routes, inter-area routes and external routes.

45.3.3.11 onfiguring Timer for Routing Calculation

You can configure the delay between when OSPF receives the topology change information and when the calculation is started. You also can configure the interval of continuously calculating SPF. Run the following command in switch configuration mode.

Command	Purpose
---------	---------

timersdelay <i>delaytime</i>	Sets the delay of routing calculation in an area.
timershold <i>holdtime</i>	Sets the minimum interval of routing calculation in an area.

45.3.3.12 onitoring and Maintaining OSPF

The network statistics information includes the content of IP routing table, cache and database. All information help you to judge the usage of network resources, solve network problems, learn the reachability of network nodes and to find routes where packets get through the network.

Run the following commands to display all routing statistics information:

Command	Purpose
Show ipospf [<i>process-id</i>]	Displays the general information of the OSPF process.
Show ip ospf [<i>process-id</i>] database show ip ospf [<i>process-id</i>] database [router] [<i>link-state-id</i>] show ip ospf [<i>process-id</i>] database [router] [self-originate] show ip ospf [<i>process-id</i>] database [router] [adv-router [<i>ip-address</i>]] show ip ospf [<i>process-id</i>] database [network] [<i>link-state-id</i>] show ip ospf [<i>process-id</i>] database [summary] [<i>link-state-id</i>] show ip ospf [<i>process-id</i>] database [asbr-summary] [<i>link-state-id</i>] show ip ospf [<i>process-id</i>] database [external] [<i>link-state-id</i>] show ip ospf [<i>process-id</i>] database [database-summary]	Displays the relative information about OSPF database.
show ip ospf border-routers	Displays internal items in the routing table between ABR and ASBR.
show ip ospf interface	Displays information about the OSPF interface.
show ip ospf neighbor	Displays information about neighbors of OSPF according to the interface.
debug ip ospf adj	Monitors the procedure of establishing OSPF adjacency.
debug ip ospf events	Monitors the OSPF interface and

	neighboring events.
debug ip ospf flood	Monitors the flooding of OSPF database.
debug ip ospf lsa-generation	Monitors the LSA generation of OSPF.
debug ip ospf packet	Monitors the OSPF message.
debug ip ospf retransmission	Monitors the message resending of OSPF.
debug ip ospf spf debug ip ospf spf intra debug ip ospf spf inter debug ip ospf spf external	Monitors the SPF calculation route of OSPF.
debug ip ospf tree	Monitors SPF tree establishment of OSPF.

45.3.4 OSPF Configuration Example

45.3.4.1 VLSM Configuration Example

OSPF and static routes support VLSMs. Through VLSMs, different masks on different interfaces can use the same network number. The IP address is thus saved and the address space is effectively utilized.

In the following example, a 30-digit subnet mask is used. A 2-digit address space is reserved for the host address of the serial port. Two host addresses are enough for the point-to-point serial link.

```
interface vlan 10
ip address 131.107.1.1 255.255.255.0
! 8 bits of host address space reserved for ethernet
interface vlan 11
ip address 131.107.254.1 255.255.255.252
! 2 bits of address space reserved for serial lines
! Router is configured for OSPF and assigned AS 107
router ospf 107
! Specifies network directly connected to the router
network 131.107.0.0 0.0.255.255 area 0.0.0.0
```

45.3.4.2 OSPF Route and Route Distribution Configuration Example

OSPF demands to exchange information among internal switches, ABR and ASBR. In the minimum configuration, the OSPF-based switch can work with default parameter settings. There is no authentication demand.

The following are three configuration examples:

The first example shows basic OSPF commands.

The second example shows how to configure internal routing switches, ABR and ASBR in an automatic system.

The third example shows how to use all kinds of OSPF tools.

45.3.4.2.1 Basic OSPF Configuration Example

The following example shows how to configure a simple OSPF. Activate the routing process 9; connect Ethernet interface 0 to area 0.0.0.0; meanwhile, send RIP to OSPF or send OSPF to RIP.

```
interface vlan 10
ip address 130.130.1.1 255.255.255.0
ip ospf cost 1
!
interface vlan 10
ip address 130.130.1.1 255.255.255.0
!
router ospf 90
network 130.130.0.0 255.255.0.0 area 0
redistribute rip
!
router rip
network 130.130.0.0
redistribute ospf 90
```

45.3.4.2.2 Example to Basic Configuration of Internal Routing Switch, ABR and ASBR

In the following example, four area lds are distributed to four IP address ranges. The routing process 109 is activated. Four areas are area 10.9.50.0, area 0, area 2 and area 3. The masks of areas 10.9.50.0, 2 and 3 are designated with address range. Area 0 includes all networks.

```
router ospf 109
network 131.108.20.0 255.255.255.0 area 10.9.50.0
network 131.108.0.0 255.255.0.0 area 2
network 131.109.10.0 255.255.255.0 area 3
network 0.0.0.0 0.0.0.0 area 0
```

Interface vlan10 is in area 10.9.50.0:

```
interface vlan 10
ip address 131.108.20.5 255.255.255.0
```

Interface vlan11 is in area 2:

```
interface vlan 11
ip address 131.108.1.5 255.255.255.0
```

Interface vlan12 is in area 2:

```
interface vlan 12
ip address 131.108.2.5 255.255.255.0
```

Interface vlan13 is in area 3:

```
interface vlan 13
ip address 131.109.10.5 255.255.255.0
```

Interface vlan14 is in area 0:

```
interface vlan 14
ip address 131.109.1.1 255.255.255.0
```

Interface vlan 100 is in area 0:

```
interface vlan 100
ip address 10.1.0.1 255.255.0.0
```

The function of network area configuration command has its order, so the sequence of the commands is important. The switch matches the IP address/mask pair according to the order. For details, refer to section *OSPF Commands*.

Check the first network area. The interface subnet 131.108.20.0 configured for area ID 10.9.50.0 is 131.108.20.0. The Ethernet interface is configured to 0. The interface is therefore in area 10.9.50.0.

In the second area, if the previous process is adopted to analyze other interfaces, interface 1 is matched. Therefore, interface 1 connects area 2.

Continue matching other network areas. Note that the last network area command is an exception, which means that all the remnant interfaces connect network area 0.

45.3.4.2.3 Complex Configuration of Interior Switches, ABR and ASBR

The following example shows how to configure multiple switches in a single OSPF automatic system. The following figure shows the network topology of the configuration example.

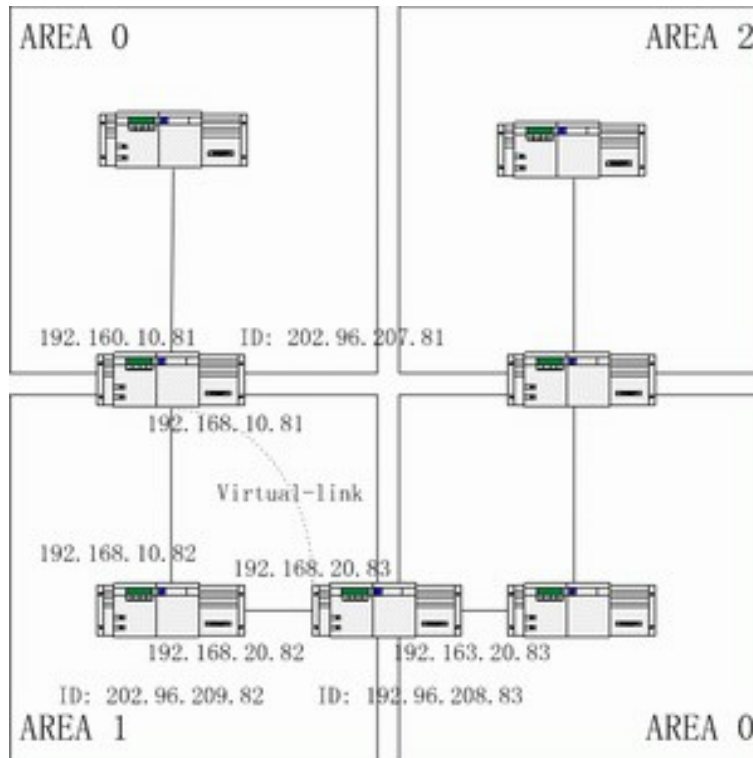

Configure switches according to the previous figure.

RTA:

```
interface loopback 0
ip address 202.96.207.81 255.255.255.0
!
interface vlan 10
ip address 192.168.10.81 255.255.255.0
!
interface vlan 10
ip address 192.160.10.81 255.255.255.0
!
router ospf 192
network 192.168.10.0 255.255.255.0 area 1
network 192.160.10.0 255.255.255.0 area 0
!
```

RTB:

```
interface loopback 0
ip address 202.96.209.82 255.255.255.252
!
interface vlan 10
ip address 192.168.10.82 255.255.255.0
!
interface vlan 11
ip address 192.160.20.82 255.255.255.0
```



```

!
router ospf 192
network 192.168.20.0 255.255.255.0 area 1
network 192.168.10.0 255.255.255.0 area 1
!
RTC:
interface loopback 0
ip address 202.96.208.83 255.255.255.252
!
interface vlan 10
ip address 192.163.20.83 255.255.255.0
!
interface vlan 11
ip address 192.160.20.83 255.255.255.0
!
router ospf 192
network 192.168.20.0 255.255.255.0 area 1
network 192.163.20.0 255.255.255.0 area 0
!

```

45.3.4.3 Configuring Complex OSPF on ABR Switch

The following case describes ABR configuration tasks.

- Configuring basic OSPF
- Distributing routes

The following figure shows the address range and area distribution.

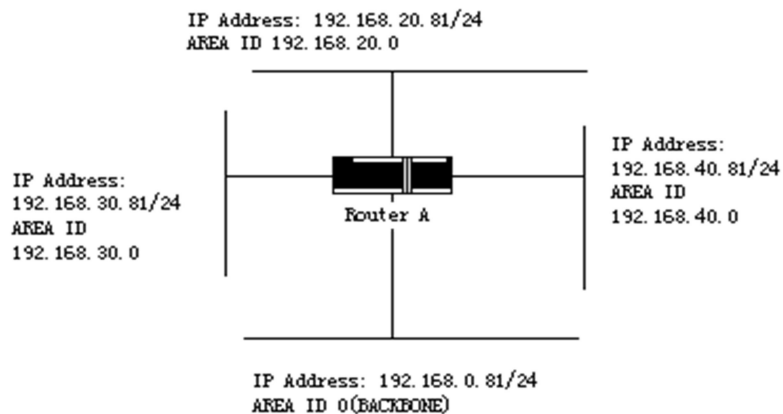

The following are basic configuration tasks:

- (1) Configuring the address range for Ethernets 0 to 3
- (2) Activating OSPF on every interface

- (3) Setting the authentication password for each area and network
- (4) Setting the link state value and other interface parameters



Use one **area** command respectively to set authentication parameters and stub area. You can use one command to set these parameters.

- Set backbone area (Area 0).

The configuration tasks relative with the distribution are listed in the following:

- Distribute IGRP routes and RIP routes to enter OSPF parameter setting (including metric-type, metric, tag and subnet).
- Distribute IGRP routes and OSPF routes to RIP.

The following is an OSPF configuration example.

```
interface vlan 10
ip address 192.168.20.81 255.255.255.0
ip ospf password GHGHGHG
ip ospf cost 10
!
interface vlan 11
ip address 192.168.30.81 255.255.255.0
ip ospf password ijklmnop
ip ospf cost 20
ip ospf retransmit-interval 10
ip ospf transmit-delay 2
ip ospf priority 4
!
interface vlan 12
ip address 192.168.40.81 255.255.255.0
ip ospf password abcdefgh
ip ospf cost 10
!
interface vlan 13
ip address 192.168.0.81 255.255.255.0
ip ospf password ijklmnop
ip ospf cost 20
ip ospf dead-interval 80
!
router ospf 192
network 192.168.0.0 255.255.255.0 area 0
network 192.168.20.0 255.255.255.0 area 192.168.20.0
```

```
network 192.168.30.0 255.255.255.0 area 192.168.30.0
network 192.168.40.0 255.255.255.0 area 192.168.40.0
area 0 authentication simple
area 192.168.20.0 stub
area 192.168.20.0 authentication simple
area 192.168.20.0 default-cost 20
area 192.168.20.0 authentication simple
area 192.168.20.0 range 36.0.0.0 255.0.0.0
area 192.168.30.0 range 192.42.110.0 255.255.255.0
area 0 range 130.0.0.0 255.0.0.0
area 0 range 141.0.0.0 255.0.0.0
redistribute rip
RIP is in network 192.168.30.0.
router rip
network 192.168.30.0
redistribute ospf 192
!
```

45.4 Configuring BGP

The chapter describes how to configure the Boundary Gateway Protocol (BGP). For details about BGP commands, refer to section “BGP Commands”. BGP is an Exterior Gateway Protocol (EGP) defined in RFC1163, 1267 and 1771. BGP allows to create a routing selection mechanism among the autonomous systems. The routing selection mechanism can ensure automatic exchange of routing selection information among the auto-managed system without loop.

45.4.1 Overview

45.4.1.1 BGP Introduction

In BGP, each route contains a network number, auto-managed system list that the route passes (as-path) and other attribute lists. Our switch software supports version 4 BGP defined in RFC1771. The basic function of BGP is to exchange network reachable information with other BGP systems, including information about the AS routing table. The information about AS routing table can be used to construct the AS connection figure and apply AS-level routing strategy through the AS connection figure. BGP Version 4 supports CIDR. CIDR reduces the size of the routing table by creating the summary route. The super network, therefore, is generated. CIDR cancels the notion of BGP network class and supports IP prefix broadcast. The CIDR can be transmitted through OSPF, enhanced IGRP, ISIS-IP and RIP2.

EGP is different from IGP with its enhanced control capability. BGP provides multiple optional methods to control the routes.

- Use neighbor-based access-list, aspath-list and prefix-list to filter the route. Or use port-based access-list and prefix-list to filter the route or the **Nexthop** attribute of the route.
- Use route-map to modify BGP route's attributes such as MED, Local Preference and Weight.
- To interact with dynamic IGRPs such as ospf and rip, you can use the **distribute** command to redistribute the route. The BGP routing information is thus automatically generated. The BGP route can be generated by manually configuring **network** and **aggregate**. When the BGP route is generated, you can use **route-map** to set the attribute of the route.
- To control the priority of BGP routes in the system, run the distance command to set the management distance of the BGP route.

45.4.1.2 BGP Route Selection

The decision procedure of BGP is based on route attribute comparing. When there are multiple routes to reach the same network, BGP selects the optimal route. The procedure of BGP selecting the optimal route is shown as follows:

- If the next hop cannot be reached, the optimal route is considered.
- If the route is an internal one and synchronization is activated, the optimal route is not considered when the route is not in IGP.
- The route with maximum weight is preferentially selected.
- If all routes have the same weight, the route with maximum local priority is preferentially selected.
- If all routes have the same local priority, the route generated by the local router is preferentially selected. For example, routes may be generated when the local router runs the **network** command or the **aggregate** command or the IGP routes are forwarded.
- If the local priority is same, or if the routes are not generated by the local router, the route with the shortest AS path is first selected.
- If the AS paths are same, the route with the smallest Origin attribute value (IGP < EGP < INCOMPLETE) is first selected.
- If the Origin attribute values is the same, the route with the smallest MED value is first selected. The MED value compare is for the routes from the same neighboring AS unless **bgp always-compare-med** is activated.
- If all routes have the same MED, the EBGp is first selected. All paths in the autonomous system are taken as IBGP.

If each route has the same connection attribute, the route with the smallest **router-id** is first selected.

45.4.2 BGP Configuration Task

45.4.2.1 Configuring Basic BGP Characteristic

BGP configuration tasks can be classified into two groups: basic tasks and advanced tasks. The first two items of basic tasks are mandatory for BGP configuration. Other items in basic tasks and advanced tasks are optional.

45.4.2.1.1 Activating BGP Routing Choice

Run the following commands in global configuration mode to activate BGP route selecting:

Command	Purpose
router bgp <i>autonomous-system</i>	Activates the BGP routing process in router configuration mode.
network <i>network-number/masklen</i> <i>[route-map route-map-name]</i>	Marks the network as the local autonomous system and adds it to the BGP table.

- (1) For EGP, when you use the router configuration command **network** to configure an IP network, you can control which network can get notification. It is contrary for IGP. For example, The RIP protocol uses the **network** command to decide where the update is sent.



- (2) You can use the **network** command to add the IGP route to the BGP routing table. The router resources, such as the configured RAM, decide the upper limit of the available **network** command. As an additional choice, you also can run the **redistribute** command.

45.4.2.1.2 Configuring BGP Neighbor

To exchange routing information with the outside, the BGP neighbor must be configured.

BGP supports two neighbors: IBGP and EBGP. The interior neighbors are in the same AS. The exterior neighbors are in a different AS. In general, exterior neighbors are closely adjacent and share a subnet; interior neighbors are in anyplace of the same AS.

Run the router configuration command to configure the BGP neighbors:

Command	Purpose
neighbor { <i>ip-address</i> } remote-asnumber	Designates a BGP neighbor.

For details, refer to the section “BGP Neighbor Configuration Example”.

45.4.2.1.3 Configuring BGP Soft Reconfiguration

In general, BGP neighbors exchange all routes only when the connection is created; they then exchange only the changed routes later. If the configured routing policy is changed, you must clear the BGP sessions before you apply the changed routing policy to the received routes. However, clearing the BGP session can disable the high-speed cache and seriously undermine network running. You are recommended to adopt the soft reconfiguration function because it helps to configure and activate policy without clearing BGP sessions.

Currently, the new soft reconfiguration function can be applied to each neighbor. The new soft reconfiguration is applied to the incoming update generated by neighbors, it is called incoming soft reconfiguration. When the

new soft reconfiguration is used to send the outgoing update to the neighbor, it is called outgoing soft reconfiguration. After the incoming soft reconfiguration is run, new input policies validates. After the outgoing soft reconfiguration is run, the new local output policy validates without resetting BGP session.

In order to generate the incoming update without resetting BGP session, the router of the local BGP session should restore the received incoming update without modification. Whether the incoming update is received or declined by the current incoming policy is not in the consideration. In this case, the memory will be badly occupied. The outgoing reconfiguration has no extra memory cost, so it is always valid. You can trigger the outgoing soft reconfiguration on the other side of the BGP session to validate the new local incoming policy. To permit the incoming soft reconfiguration, you need to configure BGP to restore all received routing update. The outgoing soft reconfiguration does not require pre-configuration.

Run the following command to configure BGP soft reconfiguration:

Command	Purpose
Neighbor { ip-address } soft-reconfiguration [inbound]	Configures BGP soft reconfiguration.

45.4.2.1.4 Resetting BGP Connection

Once two routers are defined as BGP neighbors, they will create a BGP connection and exchange route choice information. If the BGP routing policy is modified afterwards, or if other configuration is changed, you must reset the BGP connection to validate the changed configuration. Run one of the following commands to reset the BGP connection.

Command	Purpose
clear ip bgp *	Resets all BGP connections.
clear ip bgp address	Resets a special BGP connection.

45.4.2.1.5 Configuring Synchronization Between BGP and IGP

If an AS sends information at the third AS through your AS, the internal routing state of your AS must be the same as the routing information that the AS broadcasts to other ASs. For example, before all routers in your AS learn the routes through IGP, your AS may receive routing information from your BGP that some routers cannot route. The synchronization between BGP and IGP is that the BGP does not broadcast the routing information until all IGP routers in the AS learn the routing information. The synchronization is activated by default.

In some cases, you need not to perform the synchronization between BGP and IGP. If other ASs are not allowed to send data through your AS, or if all routers in your AS run BGP, the synchronization will be cancelled. After the synchronization is cancelled, your IGP can carry a few routes and BGP will aggregate more rapidly.

Run the following command to cancel the synchronization:

Command	Purpose
no synchronization	Cancel the synchronization between BGP and IGP.

When cancelling the synchronization, you need to run the command **clear ip bgp** to clear BGP sessions. For details, refer to the section “Example for Neighbor-Based BGP Path Filtration”.

In general, only one or two routes are forwarded to your IGP and become the exterior routes in IGRP or the BGP session sponsor generates a default AS route. When the routes are forwarded from BGP to IGP, only the routes obtained through EBGP can be forwarded. In most cases, your IGP is not redistributed to BGP; the networks in the AS are listed by running the router configuration command **network**; your network, therefore, will be broadcast. The network listed in this way is called as the local network; BGP has the origin attribute of IGP. These routes, such as directly-connected routes, static routes or routes learned from IGP, must be in the main IP routing table and be valid. In BGP routing process, the main IP routing table is scanned periodically to detect whether local network exists and the BGP routing table is updated afterwards. Be careful when the BGP forwards the routes. Routes in IGP may be forwarded by other routers through BGP. BGP potentially sends information to IGP and IGP then sends the information back to BGP.

45.4.2.1.6 Configuring BGP Route Weight

BGP route weight is a number that is endowed to BGP route for controlling route choice process. The weight is local for the router. The weight ranges from 0 to 65535. The default weight of the local BGP routes is 32768. The route weight obtained from the neighbor is 0. The administrator can carry out the routing policy by modifying the route weight.

Run the following command to configure the route weight:

Command	Purpose
neighbor {ip-address} weight weight	Designates a weight for all neighbor’s routes.

You can also modify the route weight through the route map.

45.4.2.1.7 Configuring Neighbor-Based BGP Routing Filtration

The router software provides the following methods to filter the BGP routes of the designated neighbor:

- (1) Use the Aspath list filter with the commands `ip aspath-list` and `neighbor filter-list`.

Command	Purpose
<code>ip aspath-list <i>aspaths-list-name</i> {permit deny} <i>as-regular-expression</i></code>	Defines a BGP-related access table.
<code>router bgp <i>autonomous-system</i></code>	Enters the router configuration mode.
<code>neighbor {ip-address} filter-list <i>aspath-list-name</i> {in out }</code>	Establishes a BGP filter.

- (2) Use the access list with the commands `ip access-list` and `neighbor distribute-list`.

Command	Purpose
<code>ip access-list <i>standard access-list-name</i></code>	Defines an access list.
<code>router bgp <i>autonomous-system</i></code>	Enters the router configuration mode.

neighbor {ip-address } distribute-listaccess-list-name {in out }	Establishes a BGP filter.
---	---------------------------

(3) Use the prefix list with the commands ip prefix-list and neighbor prefix-list.

Command	Purpose
ip prefix-listprefixs-list-name sequence number { permit deny } A.B.C.D/n ge x le y	Defines a prefix list.
router bgpautonomous-system	Enters the router configuration mode.
neighbor {ip-address } prefix-listprefix-list-name {in out}	Establishes a BGP filter.

(4) Use the route mapping with the commands route-map and neighbor route-map.

Route mapping can filter and change the routing attribute.

For details, refer to the section “Example for Neighbor-Based BGP Path Filtration”.

45.4.2.1.8 Configuring Port-Based BGP Route Filtration

You can use the access list or the prefix list to configure the port-based BGP route filtration. You can filter the network number or the gateway address of the route. You can designate the **access-list** option to use the access list, or designate the **prefix-list** option to use the prefix list to filter the network number of the route. You also can designate the **gateway** option to use the access list to filter the **NextHop** attribute of the route. The **access-list** option and the **prefix-list** option cannot be used together. The asterisk mark (*) can be designated to filter routes on all ports.

Run the following command in BGP configuration mode to configure the port-based BGP route filtration.

Command	Purpose
filter interface { in out } [access-list access-list-name] [prefix-list prefix-list-name] [gateway access-list-name]	Configures the port-based BGP route filtration.

For details, refer to the section “Example for Port-Based BGP Route Filtration”.

45.4.2.1.9 Cancelling BGP-Updated Next Hop Processing

You can cancel the next hop processing for the neighbor's BGP update. The configuration is useful in the non-broadcast networks such as frame relay or X.25. In frame relay or X.25, BGP neighbors cannot directly access all other neighbors in the same IP subnet. The following methods can cancel the next hop processing:

- The local IP address that uses the BGP connection replaces the next-hop address of the outgoing route.
- Use the route map to designate the next-hop address of the outgoing route or the incoming route.

Run the following command to cancel the next-hop processing:

Command	Purpose
neighbor {ip-address } next-hop-self	Cancels the next-hop processing when

	BGP neighbors update.
--	-----------------------

When the previous command is used, the current router notifies itself to take as the next hop of the route. Therefore, other BGP neighbors will send packets to the current router. It is useful in the non-broadcast network because a path from the current router to the designated neighbor. However, it is useless in the broadcast network because unnecessary extra hops will occur.

45.4.2.2 Configuring Senior BGP Characteristics

45.4.2.2.1 Filtering and Modifying Route Update Through Route Map

The route map can be used on each neighbor to filter the route update and modify the parameter’s attributes. The route map can be applied in both the incoming update and the outgoing update. Only the routes that pass the route map are processed when the route update is sent or received.

The route map supports that the incoming update and the outgoing update are based on the AS path, community and network number. The **aspath-list** command requires be used for the AS matching. The community matching requires the **community-list command**. **The network matching requires the ip access-list command** .

Run the following command to filter and modify the route update through the route map.

Command	Purpose
neighbor {ip-address } route-map <i>route-map-name</i> {in out}	Applies the route map to the incoming or outgoing route.

For details, refer to the section “BGP Route Map Example”.

45.4.2.2.2 Configuring Aggregation Address

The non-type inter-field route can create the aggregation route (and super network) to minimize the routing table. You can configure the aggregation route by redistributing the aggregation route to BGP or by using the aggregation attribute described in the following table. If the BGP table has at least one more detailed record, add the aggregation address to the BGP table.

Use one or several of the following command to create the aggregation address in the routing table:

Command	Purpose
aggregate network/len	Creates the aggregation address in the routing table.
aggregate network/len summary-only	Broadcasts only the summary address.
aggregate network/len route-map map-name	Generates the designated aggregation address through the route map.

Refer to the section “BGP Route Aggregation Example”.

45.4.2.2.3 Configuring BGP Community Attribute

The routing policy that BGP supports is based one of the following three values for BGP routing information:

- Routing network number

- Value of the **AS_PATH** attribute
- Value of the **COMMUNITY** attribute

Routes can be classified into the community through the COMMUNITY attribute and the community-based routing policy can be applied to routes. Therefore, the configuration of routing information control is simplified. Community is a group of routes having the same attributes. Each route may belong to multiple communities. The AS administrator can decide which community a route belongs to.

The COMMUNITY attribute is an optional, transmissible and global, which ranges from 1 to 4,294,967,200.

The famous communities that are predefined in the Internet are listed in the following table:

Community	Description
no-export	Does not broadcast the route to the EBGP peers, including the EBGP peers in the autonomous system.
no-advertise	Does not broadcast the route to any peer.
local-as	Does not broadcast the route to the outside of the autonomous system.

When generating, receiving or forwarding the route, the BGP session sponsor can set, add or modify the route community attributes. After the routes are aggregated, the aggregation contains the COMMUNITY attribute from all original routes.

The COMMUNITY attribute is not sent to neighbors by default. Run the following command to send the COMMUNITY attribute to the designated neighbor.

Command	Purpose
neighbor { <i>ip-address</i> } send-community	Sends the COMMUNITY attribute to the designated neighbor.

Perform the following operations to set the community attribute:

Command	Purpose
route-map <i>map-name</i> <i>sequence-number</i> { deny permit }	Configures the route map.
set community <i>community-value</i>	Configures the setup regulations.
router bgp <i>autonomous-system</i>	Enters the router configuration mode.
neighbor { <i>ip-address</i> } route-map <i>access-list-name</i> { in out }	Applies the route map.

Perform the following operations to configure the community-attribute-based routing information filtration:

Command	Purpose
ip community-list standard expanded <i>community-list-name</i>	Defines the community list.

{permit deny} community-expression	
route-map map-name <i>sequence-number {deny permit}</i>	Configures the route map.
match community-list-name	Configures the matching regulations.
router bgp autonomous-system	Enters the router configuration mode.
neighbor {ip-address } route-map route-map-name {in out }	Applies the route map.

Refer to the section “Example for Route Map Through BGP Community Attribute”.

45.4.2.2.4 Configuring Autonomous System Alliance

The method to reduce IBGP connections is to divide one AS into multiple sub ASs and classify them into an autonomous system alliance. As to the outside, the alliance seems like an AS. As to the inside of the alliance, each sub AS is full-connected and connects other sub ASs in the same alliance. Even if the EBGP session exists in the peers of different sub AS, they still exchange route choice information as IBGP peers do. That is, they save the next hop, MED and local priority information.

To configure a BGP autonomous system alliance, you must designate the alliance identifier. The alliance identifier is an AS number. As to the outside, the AS looks like a single AS which takes the alliance identifier as the AS number.

Run the following command to configure the identifier of the autonomous system alliance:

Command	Purpose
bgp confederation0 identifier <i>autonomous-system</i>	Configures the identifier of the autonomous system alliance.

Run the following command to designate the autonomous system number belonging to the autonomous system alliance:

Command	Purpose
bgp confederation peers <i>autonomous-system</i> [<i>autonomous-system ...</i>]	Designates the AS belonging to the autonomous system alliance.

Refer to the section “BGP Autonomous System Alliance Example”.

45.4.2.2.5 Configuring Route Reflector

Another method to reduce IBGP connections is to configure the route reflector.

The peers in the route reflector are divided into two groups: client peers and other routers in the AS (non-client peers). The route reflector reflects the routes between the two groups. The route reflector and the client peers consists of a cluster. The non-client peers must be fully connected. The client peers need not be fully connected. The clients in the cluster do not communicate with the IBGP session sponsors in the different

cluster.

When the route reflector receives the routing information, it will perform the following tasks:

- Broadcast the routes from the external BGP session sponsors to all clients and non-client peers.
- Broadcast the routes from the non-client routes to all clients.
- Broadcast the routes from the client to all client peers and non-client peers. The client peers need not be fully connected.

Run the following command to set the local router as the reflector and designate the neighbor as the client:

Command	Purpose
neighbor <i>ip-address route-reflector-client</i>	Sets the local router to the reflector and designate the neighbor as the client.

One AS has multiple route reflectors. The route reflector handles other route reflectors as it handles IBGP session sponsors. In general, the clients in the same cluster has only one route reflector. The cluster is identified by the router ID of the route reflector. To add redundancy and avoid the failure of the single node, one cluster may have several route reflectors. In this case, all route reflectors in the cluster must be set to a 4-bit cluster ID, enabling the route reflector to identify the update information of other route reflectors in the same cluster. All the route reflectors in the same cluster must be fully connected and have the same client peers and non-client peers.

If several route reflectors exists in a cluster, run the following command to configure the cluster ID:

Command	Purpose
bgp cluster-id <i>cluster-id</i>	Configures the cluster ID.

Refer to the section “BGP Route Reflector Configuration Example”.

45.4.2.2.6 Shutting down peers

Run the following command to shut down the BGP neighbors:

Command	Purpose
neighbor {ip-address} shutdown	Shuts down the BGP neighbor.

Run the following command to activate the neighbor:

Command	Purpose
no neighbor {ip-address} shutdown	Activates the BGP neighbor.

45.4.2.2.7 Configuring multihop external peers

The external peers must be in the directly-connected networks by default. Run the following command to configure multihop external peers:

Command	Purpose
neighbor {ip-address} ebgp-multihop	Sets the BGP neighbor to the multihop

ttl	external peers.
-----	-----------------

45.4.2.2.8 Setting BGP route management distance

The management distance is a unit to measure the priority of routing protocols. BGP uses three kinds of management distance: external distance, internal distance and local distance. The route learned from the external BGP shows the external distance. The route learned from the internal BGP shows the internal distance. The local route shows the local distance. Run the following command to set BGP route management distance:

Command	Purpose
distance bgp external-distance internal-distance local-distance	Sets BGP route management distance.

It is dangerous to modify the management distance of the BGP routes. You are not recommended to do it. The external distance should be shorter than the distance of any dynamic routing protocol. The internal distance should be longer than the distance of any dynamic routing protocol.

45.4.2.2.9 Modifying BGP timer

Run the following command to modify BGP **keepalive** and **holdtime** timer:

Command	Purpose
neighbor [<i>ip-address</i> <i>peer group-name</i>] timers <i>keepalive holdtime</i>	Sets the keepalive and holdtime timer for the designed peers or the peer group (unit: second).

Run the command **no neighbor timers** to resumes the timer of the BGP neighbor or the peer group to the default value.

45.4.2.2.10 omparing MED of the routes from different ASs

MED is a parameter that is considered when an optimal route needs to be selected from multiple available paths. The path with comparatively small MED value is first considered.

By default, when the best route is being chosen, the MED compare is performed only among the routes from the same AS. You can configure to allow the MED compare during route choice, no matter which AS the routes come from.

Run the following command to perform the MED compare among routes from different ASs:

Command	Purpose
bgp always-compare-med	Performs the MED compare among routes from different ASs.

45.4.3 Monitoring and Maintaining BGP

The administrator can browse and delete the content in the routing table or other databases in BGP. The value of the detailed statistics information can be displayed.

45.4.3.1 Clearing BGP routing table and database

Run the following command in management mode to perform relative tasks about clearing high-speed cache, table or BGP database.

Command	Purpose
clear ip bgp *	Resets all BGP connections.
clear ip bgp as-number	Resets the BGP connection of the designated autonomous system.
clear ip bgp address	Resets the BGP connection of the designated neighbor.
clear ip bgp address soft { in out }	Clears the incoming or outgoing database of the designated neighbor.
clear ip bgp aggregates	Clears the routes generated during route aggregation.
clear ip bgp networks	Clears the routes generated by the network command.
clear ip bgp redistribute	Clears the routes generated in the forwarding process.

45.4.3.2 Displaying routing table and system statistics information

The detailed statistics information such as the BGP routing table and the database content can be displayed. These statistics information helps you to fully use network resources and resolve network problems.

Run the following command to display different kinds of statistics information:

Command	Purpose
show ip bgp	Displays the BGP routing table in the system.
show ip bgp prefix	Displays the routs that match the prefix-matched list.
show ip bgp community	Displays the statistics information about the community attribute.
show ip bgp regexp <i>regular-expression</i>	Displays the routes that match the regular expression.
show ip bgp network	Displays the designated BGP route.
show ip bgp neighbors address	Displays the detailed information about the TCP connection and BGP connection of the designated neighbor.
show ip bgp neighbors <i>[address]</i> [received-routes routes	Displays the routes learned from a special BGP neighbor.

advertised-routes]	
show ip bgp paths	Displays all BGP path information in the database.
show ip bgp summary	Displays the state of all BGP connections.

45.4.3.3 Tracking BGP information

To locate the fault and resolve the problem, you need to observe the BGP connection establishment, route receiving and route forwarding by tracking the BGP information. Perform the following operations:

Command	Purpose
debug ip bgp *	Tracks common BGP information.
debug ip bgp all	Tracks all BGP information.
debug ip bgp fsm	Tracks the BGP state machine.
debug ip bgp keepalive	Tracks the BGP keepalive message .
debug ip bgp open	Tracks the BGP Open message.
debug ip bgp update	Tracks the BGP Update message.

45.4.4 BGP Configuration Example

45.4.4.1 BGP route map example

The following example shows how to modify the attributes of the incoming route from neighbors by using the route map. Set the weight of any route that is received from neighbor 140.222.1.1 and matches the ASPATH access list **aaa** to **200**. Set the local priority to **250**. If the route is declined, other routes are declined.

```

router bgp 100
!
neighbor 140.222.1.1 route-map fix-weight in
neighbor 140.222.1.1 remote-as 1
!
route-map fix-weight permit 10
match as-path aaa
set local-preference 250
set weight 200
!
ip aspath-list aaa permit ^690$
ip aspath-list aaa permit ^1800

```

In the following example, the first item of route map **freddy** sets the MED attribute of all routes starting from autonomous system 690 to **127**. The second item enables the routes that do not satisfy the previous conditions to be sent to neighbor 1.1.1.1:

```

router bgp 100

```

```
neighbor 1.1.1.1 route-map freddy out
!  
ip aspath-list abc permit ^690_  
ip aspath-list xyz permit .*  
!  
route-map freddy permit 10  
match as-path abc  
set metric 127  
!  
route-map freddy permit 20
```

```
match as-path xyz
```

The following example shows how to modify the routes that are generated in route forwarding through the route map:

```
router bgp 100  
redistribute rip route-map rip2bgp  
!  
route-map rip2bgp  
match ip address rip  
set local-preference 25  
set metric 127  
set weight 30000  
set next-hop 192.92.68.24  
set origin igp  
!  
ip access-list standard rip  
permit 131.108.0.0 255.255.0.0  
permit 160.89.0.0 255.255.0.0  
permit 198.112.0.0 255.255.128.0
```

45.4.4.2 BGP neighbor configuration example

In the following example, the BGP router belongs to AS109. AS109 establishes two networks. The router has three neighbors: an external neighbor (in a different AS), an internal neighbor (with the same AS number) and an external neighbor.

```
router bgp 109  
network 131.108.0.0  
network 192.31.7.0  
neighbor 131.108.200.1 remote-as 167  
neighbor 131.108.234.2 remote-as 109  
neighbor 150.136.64.19 remote-as 99
```

45.4.4.3 Example for neighbor-based BGP path filtration

The following is an example for neighbor-based BGP path filtration. The route that gets through the access list **test1** of **as-path** obtains a weight value **100**. Only the route that gets through the access list **test2** of **as-path** can be sent to neighbor 193.1.12.10. Similarly, the route that gets through the access list test3 can be accepted by neighbor 193.1.12.10:

```
router bgp 200
neighbor 193.1.12.10 remote-as 100
neighbor 193.1.12.10 filter-list test1 weight 100
neighbor 193.1.12.10 filter-list test2 out
neighbor 193.1.12.10 filter-list test3 in
ip aspath-list test1 permit _109_
ip aspath-list test2 permit _200$
ip aspath-list test2 permit ^100$
ip aspath-list test3 deny _690$
ip aspath-list test3 permit .*
```

45.4.4.4 Example for port-based BGP route filtration

The following example shows that the routes from port e1/0 are filtered through access list acl:

```
router bgp 122
filter vlan10 in access-list acl
```

The following example shows how to filter the routes from port e1/0 simultaneously using the access list **filter-network** and the access list **filter-gateway** to respectively filter the network number and the gateway address.

```
router bgp 100
filter vlan100 in access-list filter-network gateway filter-gateway
```

The following example shows how to filter routes from all ports simultaneously using the prefix list **filter-prefix** and the prefix list **filter-gateway** to respectively filter the network number and the gateway address.

```
router bgp 100
filter * in prefix-list filter-prefix gateway filter-gateway
```

45.4.4.5 Example for prefix-list-based route filtration configuration

The following example shows that the default route 0.0.0.0/0 is declined:

```
ip prefix-list abc deny 0.0.0.0/0
```

The following example shows that the route which matches the prefix 35.0.0.0/8 is allowed:

```
ip prefix-list abc permit 35.0.0.0/8
```

In the following example, only the prefixes with the length from /8 to /24 are accepted in the BGP process:

```
router bgp
network 101.20.20.0
```

```
filter * in prefix max24
```

```
!
```

```
ip prefix-list max24 seq 5 permit 0.0.0.0/0 ge 8 le 24
```

```
!
```

In the following example, the router filters all the routes and only accepts the routes whose prefix length ranges from 8 to 24:

```
router bgp 12
```

```
filter * in prefix-list max24
```

```
ip prefix-list max24 seq 5 permit 0.0.0.0/0 ge 8 le 24
```

The following example shows that route whose prefix length is no more than 24 is permitted in network 192/8:

```
ip prefix-list abc permit 192.0.0.0/8 le 24
```

The following example shows that route whose prefix length exceeds 25 is permitted in network 192/8:

```
ip prefix-list abc deny 192.0.0.0/8 ge 25
```

The following example shows that routes whose prefix length is larger than 8 and smaller than 24 are permitted:

```
ip prefix-list abc permit 0.0.0.0/0 ge 8 le 24
```

The following example shows that routes whose prefix length exceeds 25 are denied:

```
ip prefix-list abc deny 0.0.0.0/0 ge 25
```

The following example shows that all routes from network 10/8 are denied. If the mask of A-class network 10.0.0.0/8 is less than or equal to 32 bits, all routes are denied:

```
ip prefix-list abc deny 10.0.0.0/8 le 32
```

The following example shows that all routes are denied because the mask length of network 204.70.1/24 exceeds 25:

```
ip prefix-list abc deny 204.70.1.0/24 ge 25
```

The following example shows that all routes are permitted:

```
ip prefix-list abc permit any
```

45.4.4.6 BGP route aggregation example

The following example shows how to create the aggregation route in BGP through route forwarding or the conditional route aggregation function:

In the following example, the command **redistribute static** is used to forward the aggregation route 193. * . * .

```
* :
```

```
ip route 193.0.0.0 255.0.0.0 null 0
```

```
!
```

```
router bgp 100
```

```
redistribute static
```

If at least one route in the routing table belongs to the designated range, an aggregation route is created in

the BGP routing table according to the following configuration. The aggregation route is considered to be from your AS and has the **atomic** attribute which may be lost in the indication information:

```
router bgp 100
aggregate 193.0.0.0/8
```

The following example shows how to create the aggregation route 193.*.* and how to constrain more detailed routes from broadcasting to all neighbors:

```
router bgp 100
aggregate 193.0.0.0/8 summary-only
```

45.4.4.7 BGP route reflector configuration example

The following is an example for the route reflector configuration. RTA, RTB, RTC and RTE belongs to the same autonomous system AS200. RTA functions as the route reflector, while RTB and RTC function as the clients of the route reflector. RTE is a common IBGP neighbor. RTD belongs to AS100 and establishes an EBGP connection with RTA. The configuration is shown as follows:

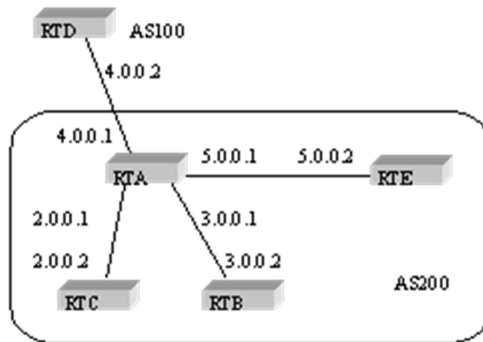

RTA configuration:

```
interface vlan110
ip address 2.0.0.1 255.0.0.0
!
interface vlan111
ip address 3.0.0.1 255.0.0.0
!
interface vlan112
ip address 4.0.0.1 255.0.0.0
!
interface vlan113
ip address 5.0.0.1 255.0.0.0
!
router bgp 200
neighbor 2.0.0.1 remote-as 200 /*RTC IBGP*/
neighbor 2.0.0.1 route-reflector-client
```

```
neighbor 3.0.0.1 remote-as 200/*RTB IBGP*/
neighbor 3.0.0.1 route-reflector-client
neighbor 5.0.0.1 remote-as 200 /*RTE IBGP*/
neighbor 4.0.0.2 remote-as 100 /*RTD EBGP*/
network 11.0.0.0/8
!
ip route 11.0.0.0 255.0.0.0 2.0.0.12
```

RTB configuration:

```
interface vlan110
ip address 3.0.0.2 255.0.0.0
!
router bgp 200
neighbor 3.0.0.1 remote-as 200 /*RTA IBGP*/
network 13.0.0.0/8
!
ip route 13.0.0.0 255.0.0.0 3.0.0.12
```

RTC configuration:

```
interface vlan110
ip address 2.0.0.2 255.0.0.0
!
router bgp 200
neighbor 2.0.0.1 remote-as 200 /*RTA IBGP*/
network 12.0.0.0/8
!
ip route 12.0.0.0 255.0.0.0 2.0.0.12
```

RTD configuration:

```
interface vlan110
ip address 4.0.0.2 255.0.0.0
!
router bgp 100
neighbor 4.0.0.1 remote-as 200 /*RTA EBGP*/
network 14.0.0.0/8
!
ip route 14.0.0.0 255.0.0.0 4.0.0.12
```

RTE configuration:

```
interface vlan110
```

```
ip address 5.0.0.2 255.0.0.0
!
router bgp 200
neighbor 5.0.0.1 remote-as 200 /*RTA IBGP*/
network 15.0.0.0/8
!
ip route 15.0.0.0 255.0.0.0 5.0.0.12
```

45.4.4.8 BGP autonomous system alliance example

The following figure shows an autonomous system alliance configuration. RTA, RTB and RTC create the IBGP connection. RTA, RTB and RTC belong to the private autonomous system 65010. RTE belongs to the private autonomous system 65020. RTE and RTA establish the EBGP connection in the autonomous system alliance. AS65010 and AS65020 make up of an autonomous system alliance. The number of the autonomous system alliance is AS200. RTD belongs to AS100. An EBGP connection is established between RTD and AS200 through RTA.

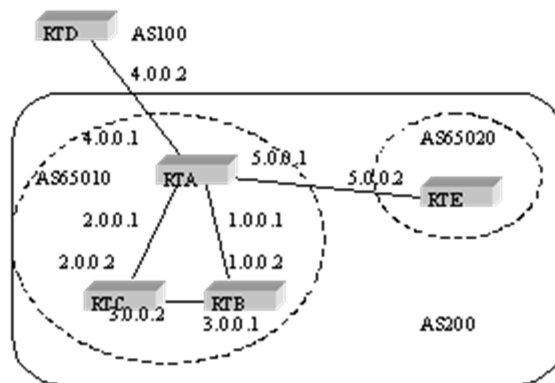

RTA configuration:

```
interface vlan110
ip address 1.0.0.1 255.0.0.0
!
interface vlan111
ip address 2.0.0.1 255.0.0.0
!
interface vlan112
ip address 4.0.0.1 255.0.0.0
!
interface vlan113
ip address 5.0.0.1 255.0.0.0
!
router bgp 65010
```

```
bgp confederation identifier 200
bgp confederation peers 65020
neighbor 1.0.0.2 remote-as 65010 /*RTB IBGP*/
neighbor 2.0.0.2 remote-as 65010 /*RTC IBGP*/
neighbor 5.0.0.2 remote-as 65020 /*RTE EBGP*/
neighbor 4.0.0.2 remote-as 100 /*RTD EBGP*/
```

RTB configuration:

```
interface vlan110
ip address 1.0.0.2 255.0.0.0
!
interface vlan111
ip address 3.0.0.1 255.0.0.0
!
router bgp 65010
bgp confederation identifier 200
bgp confederation peers 65020
neighbor 1.0.0.1 remote-as 65010 /*RTA IBGP*/
neighbor 3.0.0.2 remote-as 65010/*RTC IBGP*/
```

RTC configuration:

```
interface vlan110
ip address 2.0.0.2 255.0.0.0
!
interface vlan111
ip address 3.0.0.2 255.0.0.0
!
router bgp 65010
bgp confederation identifier 200
bgp confederation peers 65020
neighbor 2.0.0.1 remote-as 65010 /*RTA IBGP*/
neighbor 3.0.0.1 remote-as 65010 /*RTB IBGP*/
```

RTD configuration:

```
interface vlan110
ip address 4.0.0.2 255.0.0.0
!
router bgp 100
neighbor 4.0.0.1 remote-as 200 /*RTA EBGP*/
```

RTE configuration:

```
interface vlan110
ip address 5.0.0.2 255.0.0.0
!
router bgp 65020
bgp confederation identifier 200
bgp confederation peers 65010
neighbor 5.0.0.1 remote-as 65010 /*RTA EBG*/
```

45.4.4.9 Example for route map using BGP community attribute

In the following example, the command **route map set-community** is used to update the outgoing routes of neighbor 171.69.232.50. The special community attribute value **no-export** can be set through the route of the access list **aaa**. Other routes perform normal broadcast. The special community attribute value automatically prevents the BGP session sponsor in AS200 from broadcasting the route to the outside of the autonomous system.

```
router bgp 100
neighbor 171.69.232.50 remote-as 200
neighbor 171.69.232.50 send-community
neighbor 171.69.232.50 route-map set-community out
!
route-map set-community 10 permit
match ip address aaa
set community no-export
!
route-map set-community 20 permit
```

In the following example, the command **route map set-community** is used to update the outgoing routes of neighbor 171.69.232.90. Set the current value to the community attribute value **200**. Other routes performs normal broadcast.

```
route-map bgp 200
neighbor 171.69.232.90 remote-as 100
neighbor 171.69.232.90 send-community
neighbor 171.69.232.90 route-map set-community out
!
route-map set-community 10 permit
match as-path test1
set community-additive 200 200
!
route-map set-community 20 permit
match as-path test2
```

!

```
ip aspath-list test1 permit 70$
```

```
ip aspath-list test2 permit .*
```

In the following example, Set the MED and the local priority of the route from neighbor 171.69.232.55 according to the community attribute value. Set MED of all routes that match the community list **com1** to **8000**. These routes may contain routes with community value "100 200 300" and "900 901". These routes may have other attribute values.

Set the local priority of the routes which send the community list **com2** to **500**.

Set the local priority of other routes to **50**. Therefore, all the local priority value of all remaining routes of neighbor 171.69.232.55 is **50**.

```
router bgp 200
```

```
neighbor 171.69.232.55 remote-as 100
```

```
neighbor 171.69.232.55 route-map filter-on-community in
```

!

```
route-map filter-on-community 10 permit
```

```
match community com1
```

```
set metric 8000
```

!

```
route-map filter-on-community 20 permit
```

```
match community com2
```

```
set local-preference 500
```

!

```
route-map filter-on-community 30 permit
```

```
set local-preference 50
```

!

```
ip community-list com1 permit 100 200 300
```

```
ip community-list com1 permit 900 901
```

!

```
ip community-list com2 permit 88
```

```
ip community-list com2 permit 90
```

!

Chapter 46. IP Hardware Subnet Routing Configuration

46.1 IP Hardware Subnet Configuration Task

46.1.1 Overview

IP hardware subnet routing is similar to IP fast exchange.

When the IP hardware subnet routing is not enabled, before forwarding message containing the IP address A at the next hop, the switch first checks whether the item of destination A exists in the IP cache of hardware. If the item exists, the message will be forwarded through hardware. If the item does not exist, the message is sent to CPU and then processed through software. IP hardware subnet routing items include the destination subnet, mask, IP address of the next hop, interface and so on. When the IP hardware subnet routing is enabled, after the IP cache fails to be matched, the system is to check the IP hardware subnet routing items. If the matched item is found, the message will be directly forwarded through the next-hop IP address and the interface designated in the matched item. If the IP hardware subnet routing item is not found, the message will be sent to CPU for processing.

The IP hardware subnet routing has two modes: automatic and manual. In manual mode, you need to manually configure all routing items required by the IP hardware subnet routing. Note that routing items having longer mask of destination subnet should be configured earlier. In automatic mode, the system automatically adds the known routes to the hardware subnet routing. All the procedure is automatic after the hardware subnet routing is started.

46.1.2 Configuring IP Hardware Subnet Routing

Perform the following steps to configure the IP hardware subnet routing:

Step	Command	Description
1	<code>[no] ip exf {default destination mask} {cpu nexthop vlan vlanid}</code>	Add or delete a hardware subnet route. Deleting a hardware subnet route requires to specify the destination network and mask. Replace destination and mask in the command line with default when you delete a route. In this case, The next hop is not CPU. The command is effective only in manual configuration mode.
2	<code>[no] ip exf</code>	Enable or disable the IP hardware subnet routing.

46.1.3 Checking the State of IP Hardware Subnet Routing

Command	Description
show ip exf	Displays the current state of the IP hardware subnet routing.

46.2 Configuration Example

Pay attention to the following content when you configure the routing items:

- As to the direct-connecting routing, the next hop is CPU. If the next hop is a routing interface not an IP address, do as in the direct-connecting routing.
- When the number of the routing items in the system is bigger than that of the IP hardware subnet routing items, the default routing cannot be the IP hardware subnet routing. Two or several routes, which are prefix to each other, must be used together when IP hardware subnet routing is adopted. For other items, advise to add heavy-traffic items to the hardware subnet routing table. Our 3224 series switches support 15 hardware subnet routes, including the default subnet route.
- The ARP of the next-hop IP address does not exist, the system will send an ARP request and temporarily designate the next-hop routing item as CPU. After the system receives the ARP response, the system then update the next hop to the user-designating address. If the VLAN interface where the next hop resides is found different from the configured interface during the ARP response, the next hop of the route is designated as CPU. Users then need to correct the configuration.
- If the next-hop interface or the interface protocol does not exist, the item will not be added to the hardware subnet routing table.

Suppose a switch has the following routing items:

- (1) 192.168.0.0/16 next hop 192.168.26.3/vlan1
- (2) 192.168.20.0/24 next hop 192.168.26.1/vlan1
- (3) 192.168.1.0/24 direct-connecting routing
- (4) 192.168.26.0/24 direct-connecting routing
- (5) 10.0.0.0/8 next hop 192.168.1.4/vlan2
- (6) 0.0.0.0/0 next hop 192.168.1.6/vlan2

The destination subnet of route item 1 is the prefix of subnet 2, 3 and 4. Therefore, these items should be added to the hardware subnet routing table together. Item 3 and 4 are direct-connecting routing and the next hop is CPU.

The relative configuration is as follows:

```
ip exf 192.168.20.0 255.255.255.0 nexthop 192.168.26.1 vlan 1
ip exf 192.168.1.0 255.255.255.0 cpu
ip exf 192.168.26.0 255.255.255.0 cpu
ip exf 192.168.0.0 255.255.0.0 nexthop 192.168.26.3 vlan 1
ip exf 10.0.0.0 255.0.0.0 nexthop 192.168.1.4 vlan 2
```

```
ip exf 0.0.0.0 0.0.0.0 nexthop 192.168.1.6 vlan 2
```

Chapter 47. IP-PBR Configuration

47.1 IP-PBR Configuration

IP-PBR realizes software PBR functions through the hardware of switch chip.

PBR stands for Policy Based Routing. PBR enables users to rely on a certain policy not on routing protocol for routing. Software based PBR supports multiple policies and rules and also load balance. You can designate the next hop's IP address or port for those packets that are in line with policy. PBR supports load balance and applies multiple next-hop IP addresses or ports on those policy-supported packets.

Only when the next-hop egress ARP designated by route map is already learned can IP-PBR regard that this egress is valid and then the corresponding rule is effective. When a packet satisfies IP-PBR policy, the hardware directly forwards this packet to the next-hop egress that the rule specifies. This process is finished by the hardware without the operation of CPU. The packets forwarded by IP-PBR have the highest priority and only those packets unmatched with IP-PBR rule are forwarded to CPU.

The current IP-PBR supports the IP ACL policy and the next-hop IP address policy. When multiple next hops are configured, the first effect next hop is chosen. IP-PBR also supports equivalent routing that is realized by the switch chip. Hardware equivalent routing needs no extra configuration.

IP-PBR supports the following policy routing commands:

route-map*WORD*

match ip address*WORD*

set ip next-hop*X.X.X.X [load-balance]*

ip policy route-map *WORD*

IP-PBR is a little different from router's policy routing. IP-PBR chooses an effective next hop as the egress and drops packets if no valid next hop available, while router's policy routing selects an effective next hop but packet loss happens if this next hop has not learned ARP. Once multiple sequences are set, one difference between IP-PBR and software policy routing must be noted. Software policy routing always chooses high-priority sequence routes no matter whether IP address matched by high-priority sequences overlaps with that matched by low-priority sequences and whether these routes are effective, while IP-PBR chooses low-priority sequence routes when high-priority sequence routes invalidate.

47.1.1 Enabling or Disabling IP-PBR Globally

Run the following commands in global configuration mode.

Command	Purpose
ip pbr	The IP-PBR function is disabled by default.
no ip pbr	Resumes the default settings.

IP-PBR is disabled by default.

47.1.2 ISIS Configuration Task List

To configure IP-PBR, do as follows:

Create ACL;

Create a route map;

Apply the route map on a port;

To create an ACL, run the following command globally:

Command	Remarks
ip access-list standard net1	Enters the ACL configuration mode and defines ACL.

To create a route map, run the following commands globally:

Command	Remarks
route-map pbr	Enters the route map configuration mode.
match ip address access-list	Configures the match-up policy.
set ip next-hop A.B.C.D	Configures the next-hop address of IP packet.

To apply policy routing on an IP-receiving port, run the following commands:

Command	Remarks
interface interface_name	Enters the interface configuration mode.
ip policy route-map route-map_name	Applies policy routing on the port.

47.1.3 Monitoring and Maintaining MVC

Run the following commands in EXEC mode:

Command	Operation
show ip pbr	It is used to display the information about RIP configuration.
show ip policy	Shows the port on which IP-PBR is applied.
show ip pbr policy	It is used to display the information about IP-PBR equivalent routing.
debug ip pbr	It is used to enable or disable the debugging switch of IP-PBR.

The information that IP-PBR is not running is shown:

```
switch#show ip pbr
```

IP policy based route state: disabled

No pbr apply item

No equiv exf apply item

All data related about IP-PBR running are shown below:

switch#**show ip pbr**

IP policy based route state: enabled

No equiv exf apply item

VLAN3 use route-map ddd, and has 1 entry active.

Entry sequence 10, permit

Match ip access-list:

ac1

Set Outgoing nexthop

90.0.0.3

The IP-PBR policy routing information is shown below:

switch#**show ip pbr policy**

IP policy based route state: enabled

VLAN3 use route-map ddd, and has 1 entry active.

Entry sequence 10, permit

Match ip access-list:

ac1

Set Outgoing nexthop

90.0.0.3

The equivalent routing information is shown below:

switch#**show ip pbr exf**

```
IP policy based route state: enabled
```

```
Equiv EXF has 1 entry active.
```

```
-----  
Entry sequence 1, handle c1f95b0
```

```
Dest ip: 1.1.0.0/16
```

```
90.0.0.3
```

```
192.168.213.161
```

47.1.4 IP-PBR Configuration Example

Switch configuration:

```
!  
ip pbr  
!  
interface vlan1  
ip address 10.1.1.3 255.255.255.0  
no ip directed-broadcast  
ip policy route-map pbr  
!  
ip access-list standard ac1  
permit 10.1.1.21 255.255.255.255  
!  
ip access-list standard ac2  
permit 10.1.1.2 255.255.255.255  
!  
route-map pbr 10 permit  
match ip address ac1  
set ip next-hop 13.1.1.99  
!  
route-map pbr 20 permit  
match ip address ac2  
set ip next-hop 13.1.1.99 14.1.1.99load-balance  
!
```

Configuration Description

The switch is to apply policy routing on the packets that are received from VLAN1. As to the packets whose source IPs are 10.1.1.21, their next hop is 13.1.1.99. As to the packets whose source IPs are 10.1.1.2, they are applied on **route-map pbr 20**; because **set ip next-hop** has the **load-balance** parameter, the switch chip

will automatically choose 13.1.1.99 or 14.1.1.99 as the egress according to destination IP address.

Chapter 48. Multi-VRF CE Configuration

48.1 Multi-VRF CE Introduction

48.1.1 Overview

The Virtual Private Network (VPN) provides a secure method for multiple client networks to share the ISP-supplied bandwidth. In general, one VPN comprises a team of client networks that share a public routing table on the ISP's routers. Each client network is connected to the interface of the network devices of ISP, while ISP's device will relate each interface to a VPN routing table. One VPN routing table is also called as a VRF (VPN Routing /Forwarding table).

VRF is usually deployed on a Provider Edge (PE) device, such as MPLS VRF VPN. A PE supports multiple VPNs, and each VPN has its independent IP address space among which IP addresses can be overlapped. The VPN of a different client connects a different interface of PE, while PE differentiates the to-be-checked routing tables according to the incoming port of the packet.

Multi-VRF CE is to remove the task of connecting multiple client networks from PE to CE, which only requires a physical link to connect CE and PE. In this way, the port resource of PE is saved. CE also maintains the VRF routing table for each VPN. The packets from the client network are first forwarded on CE and then transmitted to PE after the packets pass through the ISP network.

The switch which serves as MCE connects different client networks through different ports and then relates these ports to a VPN routing table. The switch only supports VRF settings on the VLAN port.

The MCE function is usually deployed at the edge of the large-scale MPLS-VRF VPN network. The three functions, Multi-VRF CE, MPLS label switching and the function of MPLS control layer, are independent.

Figure 1.1 shows an MPLS-VRF VPN network.

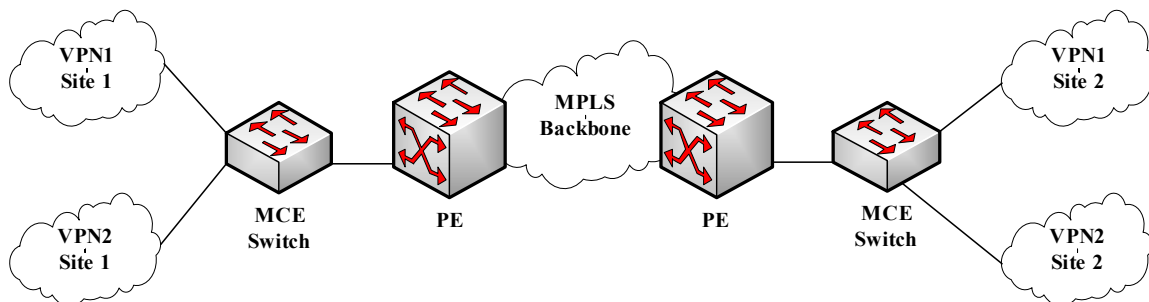

Figure 1.1 MCE in the MPLS-VRF VPN network

48.1.1.1 Establishing Routes with CE

The Multi-VRF CE switch can establish routes with CE through multiple dynamic routing protocols. CE can be routers or the Ethernet switches. The routing protocols which are supported include OSPF, RIP and BEIGRP. The MCE switch also supports static routing configuration.

The MCE switch generally needs different VLAN ports to connect CEs that belong to different VPNs. The VLAN ports that are used to connect the VPNs require to be related to a VRF. CE does not need to support

VRF.

48.1.1.2 Establishing Routes with PE

The MCE switch (MCE) can connect one or multiple PEs, but both MCE and the connected PEs have to get VRF configured. MCE will provide PE the routes which MCE learns from CE and learns the routes of remote client networks from PE.

The VRF route can be established between MCE and PE through dynamic routing protocols such as BGP, OSPF, RIP and BEIGRP. Of course, the VRF route can also be established statically.

In general, MCE and PE belong to different autonomous systems. Hence, the method to establish the VRF route between MCE and PE by using EBGP is the key point in this document.

48.2 Multi-VRF CE Configuration

48.2.1 Default VRF Configuration

Function	Default Configuration
VRF	There is no configuration. All routes are added to the default routing table.
VPN expansibility of VRF	There is no Routing Distinguisher (RD). There is no input/output Routing Target (RT).
Maximum number of VRF routes	10240
VRF port	N/A. None of VLAN ports is related with VRF, and the routes of ports are added to the default routing table.
IP Express Forwarding	The hardware IP routing is not enabled.

48.2.2 MCE Configuration Tasks

- Configuring VRF
- Configuring a VPN Route
- Configuring BGP Route Between PE and CE
- Testifying the VRF Connectivity between PE and CE

48.2.3 MCE Configuration

48.2.3.1 Configuring VRF Refer to the following steps to configure one or multiple VRFs.

Command	Purpose
Switch# config	Enters the switch configuration mode.
Switch_config# ip vrf <i>vrf-name</i>	Creates VRF and enters the VRF configuration mode. vrf-name: VRF name with up to 31 characters

Switch_config_vrf# rd <i>route-distinguisher</i>	Sets the route distinguisher of VRF. route-distinguisher: Stands for the distinguisher of the route. It consists of autonomous domain ID and random numbers, or IP and random numbers.
Switch_config_vrf# route-target { export import both } <i>route-target-extended-community</i>	Creates the expanded VPN attributes of input/output VRF objects. route-target-extended-community: It consists of autonomous domain ID and random numbers, or IP and random numbers.
Switch_config_vrf# interface <i>intf-name</i>	Enters the interface configuration mode. intf-name: Stands for the name of an interface.
Switch_config_intf# ip vrf forwarding <i>vrf-name</i>	Relates the L3 interface with VRF. vfi-name: Means the name of VRF.
Switch_config_intf# exit	Exits from interface configuration mode.
Switch_config# ip exf	Enables ip hardware routing .
Switch_config# show ip vrf [brief detail interface] [<i>vrf-name</i>]	Browses the VRF information.
Switch_config#no ip vrf <i>vrf-name</i>	Deletes the configured VRF and the relation between VRF and the L3 interface. vfi-name: Means the name of VRF.
Switch_config_intf# no ip vrf forwarding [<i>vrf-name</i>]	Deletes the relation between the L3 interface and VRF.

48.2.3.2 Configuring VPN Route

The route can be established between MCE and customer device through the configuration of BGP, OSPF, RIP, BEIGRP or static route. The following takes OSPF configuration as an example, which is similar to other routes' configurations.



When a route is configured on MCE to connect the client network, the VRF attributes of the routing protocol need be specified. VRF need not be configured on the customer device.

Command	Purpose
Switch# config	Enters the switch configuration mode.
Switch_config# router ospf <i>process-id vrf vrf-name</i>	Starts the OSPF-VRF route and enters the configuration mode.
Switch_config_ospf# <i>networknetwork-number</i> <i>network-maskareaarea-id</i>	Defines the OSPF network, mask and area ID.

Switch_config_ospf# redistribute bgp <i>ASN</i>	Forwards the designated BGP network to the OSPF network.
Switch_config_ospf# exit	Exits from the OSPF configuration mode.
Switch_config# show ip ospf	Browses the information about the OSPF protocol.
Switch_config# no router <i>ospfprocess-id</i>	Deletes the OSPF-VRF routing configuration.

48.2.3.3 Configuring the BGP Route Between PE and CE

Refer to the following configuration commands:

Command	Purpose
Switch# config	Enters the switch configuration mode.
Switch_config# router bgp <i>autonomous-system-number</i>	Starts the BGP protocol by designating autonomous system number and enters the BGP configuration mode.
Switch_config_bgp# bgp log-neighbor-changes	Starts the record about BGP neighbor change.
Switch_config_bgp# address-family ipv4 vrf <i>vrf-name</i>	Enters the configuration mode of VRF address-family.
Switch_config_bgp_af# redistribute ospf <i>ospf-process-id</i>	Forwards the OSPF routing information to the BGP network.
Switch_config_bgp_af#network <i>net work-number/prefix-length</i>	Configures the network number and the mask's length that are distributed by BGP.
Switch_config_bgp_af# neighbor <i>address remote-asASN</i>	Configures the BGP neighbor and the autonomous system number of a neighbor.
Switch_config_bgp_af# exit-address-family	Exits from the configuration mode of address-family.
Switch_config_bgp# exit	Exits from the BGP configuration mode.
Switch_config# show ip bgp vpv4 [all rd vrf]	Browses the BGP-VRF routing information.
Switch_config# no router bgp <i>ASN</i>	Deletes the BGP routing configuration.

48.2.3.4 Testifying the VRF Connectivity Between PE and CE

Use the PING command with the VRF option to testify the VRF connectivity of PE and CE.

Command	Purpose
Switch# ping -vrf <i>vrf-name</i> <i>ip-address</i>	Conducts the PING operation to the addresses in VRF.

48.3 MCE Configuration Example

Figure 2.1 shows a simple VRF network. Both S1 and S2 are the Multi-VRF CE switches. S11, S12 and S13 belong to VPN1, S21 and S22 belong to VPN2, and all of them are customer devices. The OSPF route should be configured between CE and customer device, while the BGP route is configured between CE and PE.

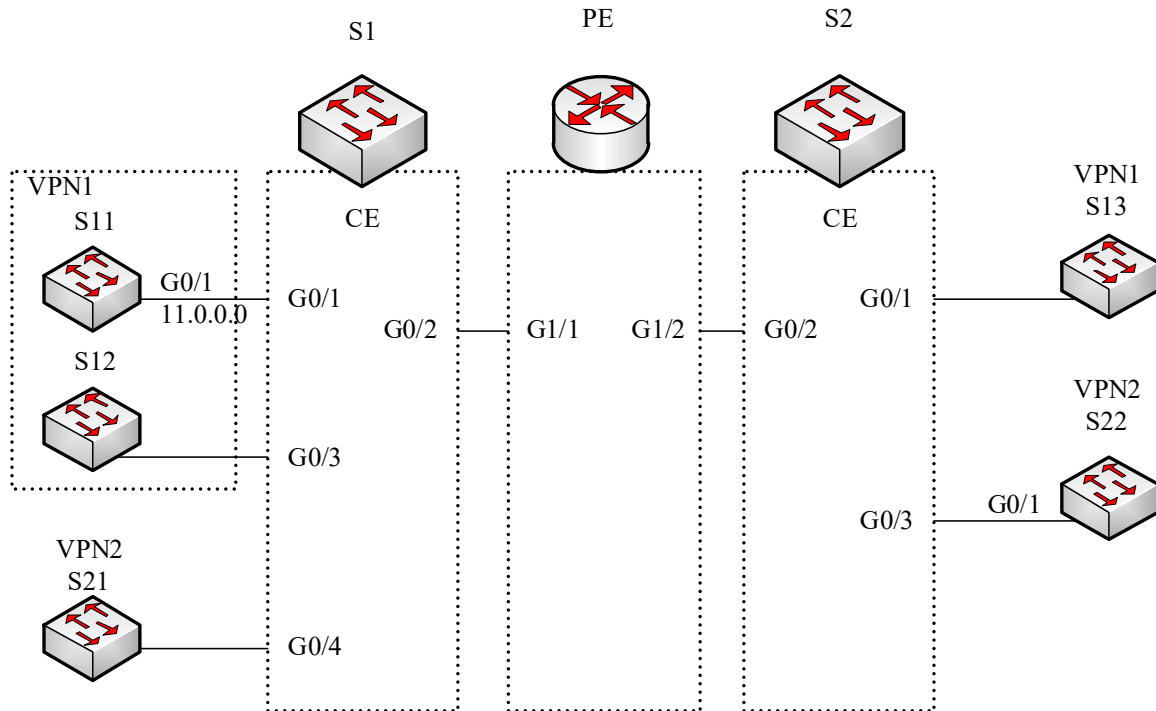

Figure 2.1 MCE configuration example

48.3.1 Configuring S11

Set the VLAN attributes of the physical interface that connects CE:

```
Switch_config# interface gigaEthernet 0/1
Switch_config_g0/1# switchport pvid 11
Switch_config_g0/1# exit
```

Sets the IP address and the VLAN interface.

```
Switch_config# interface VLAN11
Switch_config_v11# ip address 11.0.0.2 255.0.0.0
Switch_config_v11# exit
```

Set the routing protocol between CE and customer's device:

```
Switch_config# router ospf 101
Switch_config_ospf_101# network 11.0.0.0 255.0.0.0 area 0
Switch_config_ospf_101# exit
```

48.3.2 Configuring MCE-S1

Configures VRF on the Multi-VRF CE device.

```
Switch#config
```

```
Switch_config# ip vrf vpn1
```

```
Switch_config_vrf_vpn1# rd 100: 1
```

```
Switch_config_vrf_vpn1# route-target export 100: 1
```

```
Switch_config_vrf_vpn1# route-target import 100: 1
```

```
Switch_config_vrf_vpn1# exit
```

```
Switch_config# ip vrf vpn2
```

```
Switch_config_vrf_vpn2# rd 100: 2
```

```
Switch_config_vrf_vpn2# route-target export 100: 2
```

```
Switch_config_vrf_vpn2# route-target import 100: 2
```

```
Switch_config_vrf_vpn2# exit
```

Configure the loopback port and the physical port, and use the address of the loopback port as the router ID of the BGP protocol.

```
Switch_config# interface loopback 0
```

```
Switch_config_l0# ip address 101.0.0.1 255.255.255.255
```

```
Switch_config_l0# exit
```

S1 connects S11 through the F0/1 port, S21 through the G0/4 port and PE through the G0/2 port.

```
Switch_config# interface gigaEthernet 0/1
```

```
Switch_config_g0/1# switchport pvid 11
```

```
Switch_config_g0/1# exit
```

```
Switch_config# interface gigaEthernet 0/4
```

```
Switch_config_g0/4# switchport pvid 15
```

```
Switch_config_g0/4# exit
```

```
Switch_config# interface gigaEthernet 0/2
```

```
Switch_config_g0/2# switchport mode trunk
```

```
Switch_config_g0/2# exit
```

Set the L3 VLAN port of a switch, bind the VRF to the VLAN port and set the IP address. S1 connects PE through two logical ports, VLAN21 and VLAN22. The two ports, VLAN11 and VLAN15, connect VPN1 and VPN2 respectively.

```
Switch_config# interface VLAN11
```

```
Switch_config_v11# ip vrf forwarding vpn1
```

```
Switch_config_v11# ip address 11.0.0.1 255.0.0.0
```

```
Switch_config_v11# exit
```

```
Switch_config# interface VLAN15
```

```
Switch_config_v15# ip vrf forwarding vpn2
```

```
Switch_config_v15# ip address 15.0.0.1 255.0.0.0
```

```
Switch_config_v15# exit
```

```
Switch_config# interface VLAN21
```

```
Switch_config_v21# ip vrf forwarding vpn1
```

```
Switch_config_v21# ip address 21.0.0.2 255.0.0.0
```

```
Switch_config_v21# exit
```

```
Switch_config# interface VLAN22
```

```
Switch_config_v22# ip vrf forwarding vpn2
```

```
Switch_config_v22# ip address 22.0.0.2 255.0.0.0
```

```
Switch_config_v22# exit
```

Configure the OSPF route between CE and customer device.

```
Switch_config# router ospf 1 vrf vpn1
```

```
Switch_config_ospf_1# network 11.0.0.0 255.0.0.0 area 0
```

```
Switch_config_ospf_1# redistribute bgp 100
```

```
Switch_config_ospf_1#exit
```

```
Switch_config# router ospf 2 vrf vpn2
```

```
Switch_config_ospf_2# network 15.0.0.0 255.0.0.0 area 0
```

```
Switch_config_ospf_2# redistribute bgp 100
```

```
Switch_config_ospf_2#exit
```

Configure the EBGP route between PE and CE.

```
Switch_config# router bgp 100
```

```
Switch_config_bgp# bgp log-neighbor-changes
```

```
Switch_config_bgp# address-family ipv4 vrf vpn1
```

```
Switch_config_bgp_vpn1# no synchronization
```

```
Switch_config_bgp_vpn1# redistribute ospf 1
```

```
Switch_config_bgp_vpn1# neighbor 21.0.0.1 remote-as 200
```

```
Switch_config_bgp_vpn1# exit-address-family
```

```
Switch_config_bgp# address-family ipv4 vrf vpn2
```

```
Switch_config_bgp_vpn2# no synchronization
Switch_config_bgp_vpn2# redistribute ospf 2
Switch_config_bgp_vpn2# neighbor 22.0.0.1 remote-as 200
Switch_config_bgp_vpn2# exit-address-family
Switch_config_bgp# exit
```

Create VLAN.

```
Switch_config# vlan 1,11-12,21-22
```

Enables the forwarding of subnet route of the switch.

```
Switch_config# ip exf
```

48.3.3 Configuring PE

Set VRF on PE:

```
Switch#config
Switch_config# ip vrf vpn1
Switch_config_vrf_vpn1# rd 200: 1
Switch_config_vrf_vpn1# route-target export 200: 1
Switch_config_vrf_vpn1# route-target import 200: 1
Switch_config_vrf_vpn1# exit
```

```
Switch_config# ip vrf vpn2
Switch_config_vrf_vpn2# rd 200: 2
Switch_config_vrf_vpn2# route-target export 200: 2
Switch_config_vrf_vpn2# route-target import 200: 2
Switch_config_vrf_vpn2# exit
```

Set the loopback interface as the router identifier:

```
Switch_config# interface loopback 0
Switch_config_l0# ip address 102.0.0.1 255.255.255.255
Switch_config_l0# exit
```

Set the physical interface which connects PE and CE: G1/1 and G1/2 connect S1 and S2 respectively:

```
Switch_config# interface gigaEthernet 1/1
Switch_config_g1/1# switchport mode trunk
Switch_config_g1/1# interface gigaEthernet 1/2
Switch_config_g1/2# switchport mode trunk
Switch_config_g1/2# exit
```

Set the L3 VLAN interface of PE, which connects S1:

```
Switch_config# interface VLAN21
Switch_config_v21# ip vrf forwarding vpn1
Switch_config_v21# ip address 21.0.0.1 255.0.0.0
Switch_config_v21# exit
```

```
Switch_config# interface VLAN22
Switch_config_v22# ip vrf forwarding vpn2
Switch_config_v22# ip address 22.0.0.1 255.0.0.0
Switch_config_v22# exit
```

Set the L3 VLAN interface of PE, which connects S2:

```
Switch_config# interface VLAN31
Switch_config_v31# ip vrf forwarding vpn1
Switch_config_v31# ip address 31.0.0.1 255.0.0.0
Switch_config_v31# exit
```

```
Switch_config# interface VLAN32
Switch_config_v32# ip vrf forwarding vpn2
Switch_config_v32# ip address 32.0.0.1 255.0.0.0
Switch_config_v32# exit
```

Set the EBGp of PE:

```
Switch_config# router bgp 200
Switch_config_bgp# bgp log-neighbor-changes
Switch_config_bgp# address-family ipv4 vrf vpn1
Switch_config_bgp_vpn1# no synchronization
Switch_config_bgp_vpn1# neighbor 21.0.0.2 remote-as 100
Switch_config_bgp_vpn1# neighbor 31.0.0.2 remote-as 300
Switch_config_bgp_vpn1# exit-address-family
```

```
Switch_config_bgp# address-family ipv4 vrf vpn2
Switch_config_bgp_vpn2# no synchronization
Switch_config_bgp_vpn2# neighbor 22.0.0.2 remote-as 100
Switch_config_bgp_vpn2# neighbor 32.0.0.2 remote-as 300
Switch_config_bgp_vpn2# exit-address-family
Switch_config_bgp# exit
```

Set VLAN and enable the subnet routing forwarding.

```
Switch_config# vlan 1,21-22,31-32
```

```
Switch_config# ip exf
```

48.3.4 Configuring MCE-S2

Configures VRF:

```
Switch#config
```

```
Switch_config# ip vrf vpn1
```

```
Switch_config_vrf_vpn1# rd 300: 1
```

```
Switch_config_vrf_vpn1# route-target export 300: 1
```

```
Switch_config_vrf_vpn1# route-target import 300: 1
```

```
Switch_config_vrf_vpn1# exit
```

```
Switch_config# ip vrf vpn2
```

```
Switch_config_vrf_vpn2# rd 300: 2
```

```
Switch_config_vrf_vpn2# route-target export 300: 2
```

```
Switch_config_vrf_vpn2# route-target import 300: 2
```

```
Switch_config_vrf_vpn2# exit
```

Configure the loopback port and the physical port, and use the address of the loopback port as the router ID of the BGP protocol.

```
Switch_config# interface loopback 0
```

```
Switch_config_l0# ip address 103.0.0.1 255.255.255.255
```

```
Switch_config_l0# exit
```

S2 connects S13 through the F0/1 port, S22 through the G0/3 port and PE through the G0/2 port.

```
Switch_config# interface gigaEthernet 0/1
```

```
Switch_config_g0/1# switchport pvid 41
```

```
Switch_config_g0/1# exit
```

```
Switch_config# interface gigaEthernet 0/3
```

```
Switch_config_g0/3# switchport pvid 46
```

```
Switch_config_g0/3# exit
```

```
Switch_config# interface gigaEthernet 0/2
```

```
Switch_config_g0/2# switchport mode trunk
```

```
Switch_config_g0/2# exit
```

Set the L3 VLAN port of a switch, bind the VRF to the VLAN port and set the IP address. S2 connects PE through two logical ports, VLAN31 and VLAN32. The two ports, VLAN41 and VLAN46, connect VPN1 and VPN2 respectively.

```
Switch_config# interface VLAN41
Switch_config_v41# ip vrf forwarding vpn1
Switch_config_v41# ip address 41.0.0.1 255.0.0.0
Switch_config_v41# exit
```

```
Switch_config# interface VLAN46
Switch_config_v46# ip vrf forwarding vpn2
Switch_config_v46# ip address 46.0.0.1 255.0.0.0
Switch_config_v46# exit
```

```
Switch_config# interface VLAN31
Switch_config_v31# ip vrf forwarding vpn1
Switch_config_v31# ip address 31.0.0.2 255.0.0.0
Switch_config_v31# exit
```

```
Switch_config# interface VLAN32
Switch_config_v32# ip vrf forwarding vpn2
Switch_config_v32# ip address 32.0.0.2 255.0.0.0
Switch_config_v32# exit
```

Configure the OSPF route between CE and customer device.

```
Switch_config# router ospf 1 vrf vpn1
Switch_config_ospf_1# network 41.0.0.0 255.0.0.0 area 0
Switch_config_ospf_1# redistribute bgp 300
Switch_config_ospf_1#exit
```

```
Switch_config# router ospf 2 vrf vpn2
Switch_config_ospf_2# network 46.0.0.0 255.0.0.0 area 0
Switch_config_ospf_2# redistribute bgp 300
Switch_config_ospf_2# exit
```

Configure the EBGP route between PE and CE.

```
Switch_config# router bgp 300
Switch_config_bgp# bgp log-neighbor-changes
```

```
Switch_config_bgp# address-family ipv4 vrf vpn1
Switch_config_bgp_vpn1# no synchronization
Switch_config_bgp_vpn1# redistribute ospf 1
Switch_config_bgp_vpn1# neighbor 31.0.0.1 remote-as 200
Switch_config_bgp_vpn1# exit-address-family
```

```
Switch_config_bgp# address-family ipv4 vrf vpn2
Switch_config_bgp_vpn2# no synchronization
Switch_config_bgp_vpn2# redistribute ospf 2
Switch_config_bgp_vpn2# neighbor 32.0.0.1 remote-as 200
Switch_config_bgp_vpn2# exit-address-family
Switch_config_bgp# exit
```

Create VLAN.

```
Switch_config# vlan 1,31-32,41,46
```

Enables the forwarding of subnet route of the switch.

```
Switch_config# ip exf
```

48.3.5 Setting S22

Set the VLAN attributes of the physical interface of CE, and connect S22 and S2 through interface f0/1:

```
Switch_config# interface gigaEthernet 0/1
Switch_config_g0/1# switchport pvid 46
Switch_config_g0/1# exit
```

Sets the IP address and the VLAN interface.

```
Switch_config# interface VLAN46
Switch_config_v46# ip address 46.0.0.2 255.0.0.0
Switch_config_v46# exit
```

Set the routing protocol between CE and customer's device:

```
Switch_config# router ospf 103
Switch_config_ospf_103# network 46.0.0.0 255.0.0.0 area 0
Switch_config_ospf_103# exit
```

48.3.6 TestifyingVRF Connectivity

Run the PING command on S1 to testify the connectivity of VPN1 between S1 and S11:

```
Switch# ping -vrf vpn1 11.0.0.2
!!!!
--- 11.0.0.2 ping statistics ---
5 packets transmitted, 5 packets received, 0% packet loss
round-trip min/avg/max = 0/0/0 ms
```

Testify the connectivity between S1 and PE:

```
Switch# ping -vrf vpn1 21.0.0.1
```

```
!!!!
```

```
--- 21.0.0.1 ping statistics ---
```

```
5 packets transmitted, 5 packets received, 0% packet loss
```

```
round-trip min/avg/max = 0/0/0 ms
```

Chapter 49. Reliability Configuration

49.1 Configuring Port Backup

This chapter discusses how to back up the interface, describes the backup functions on the asynchronism serial interface, synchronism serial interface or ISDN interface.

For details about interface backup commands, refer to *Interface Backup Command Reference*.

49.1.1 Overview

Interface backup functions can enabled Backup interface or disabled it according to statement or flux information of Primary interface .If primary interface is down because of lines and etc., backup interface will enabled auto and data can send or receive through it instead of primary interface. It can add reliability from source router to destination. If flux of primary interface is crowded, it can activate backup interface also, share the data transportations to speed up data transportations. If primary interface is between “down” and “up” or flux of primary interface and backup interface are both small, backup interface can be activated but not transporting data. This can save cost of lines .The listing interfaces can be primary interface:

- asynchronism serial port
- ISDN
- synchronism serial port

Except above types, backup interfaces include Dialer logic interface also.

49.1.2 Backup InterfaceConfigratoin Task List

If you want to configure interface backup in above interfaces ,you should do as follows in interface configure mode.

- Enabling backup and choosing the backup interface

You can also do these tasks. These tasks are optional, can provide many uses and enforce interface backup functions.

- enabling interface backup rejection
- enabling flux equalization backup

49.1.3 Backup InterfaceConfigratoin Task

49.1.3.1 Enabling Backup and Choosing the Backup Interface

To realize interface backup functions, you should configure backup interface of this interface first. You can use instructions as follows in interface configuration mode.

Command	Purpose
backup interfaceslot/port	choose backup interface of this interface.

49.1.3.2 Enabling Backup Interface Rejection

Set delaying of enabled and disabled backup interface .To realize time gap between primary interface state changing and the result of state of backup interface changing.

1. choose backup interface
2. enabled interface backup delaying in this interface .

choose backup interface,You can use instructions as follows in interface configuration mode.

Command	Purpose
Backup interfaceslot/port	Choose backup interface of this port.

Enabled interface backup delaying , You can use instructions as follows in interface configuration mode.

Command	Purpose
backup delay {enable-delay never } {disable-delay never }	Difine backup interface activation and deactivation delaying.

49.1.3.3 Enabling Flux Equilization Backup

Flux equilization backup function will work if real flux of primary interface pass the percentage limit, backup interface will be activated to work state. If real flux of primary interface and backup interface is less than percentage limit to primary band width , backup interface will be activated to backup state.

Enabled flux equalization backup, you should execute tasks as follows:

- choosing the backup interface
- enabling flux equalization of this interface

49.1.3.3.1 Choosing backup interface.

You can use instructions as follows in interface configuration mode.

Command	Purpose
Backup interfaceslot/port	Choose backup interface of this interface

49.1.3.3.2 Enabling flux equalization of this interface.

You can use instructions as follows in interface configuration mode.

Command	Purpose
Backup load [enable-threshold never][disable-thresh old never]	Configure interface backup flux to activate or deactivate backup interface limit.

49.1.4 Examples of Port Backup Configuration

Enable the backup interface on serial interface 1/0,and choose serial interface 1/1 as his backup interface.

The time of backup interface activation and deactivation is both 5 seconds. Flux equalization setting is when true flux of primary interface pass 60% of band width , activate backup interface, while flux through both interfaces is less than 30% of band width of primary interface, activate backup interface.

```
configure routers
interface s1/0
backup interface int s1/1
backup delay 5 5
backup load 70 30
```

It is enabled when the primary interface is “down”, while the dialing backup interface is always connected. If the backup interface is a normal dialing interface, when the primary interface is down and the backup interface does not need to send data, the backup interface will not dial initiative, only dial when sending data .After enabled this ,regardless of transporting data, when primary interface is “down”, backup interface will dial at once to connect.(if you take slow dial interface as backup interface ,it is fit).

Enabled flux equalization backup, you must execute tasks as follows:

- Choose backup interface
- enabled backup interface dial at once when primary interface is “down”.

1. Choose backup interface. You can use instructions as follows in interface configuration mode.

Command	Purpose
backup interface slot/port	Choose backup interface of this interface .

2. Enabled backup interface dial at once when primary interface is “down”.

You can use instructions as follows in interface configuration mode.

Command	Purpose
backup always	When primary interface is down, backup Interface is always connected.

For an example(a0/0 as a dial interface)

```
configure router
interface s1/0
backup interface a0/0
backup always
```

49.2 Configuring HSRP protocol

49.2.1 Overview

HSRP is a standard method of providing high network availability by providing first-hop redundancy for IP hosts on an IEEE 802 LAN configured with a default gateway IP address. HSRP routes IP traffic without

relying on the availability of any single router. It enables a set of router interfaces to work together to present the appearance of a single virtual router or default gateway to the hosts on a LAN. When HSRP is configured on a network or segment, it provides a virtual Media Access Control (MAC) address and an IP address that is shared among a group of configured routers. HSRP allows two or more HSRP-configured routers to use the MAC address and IP network address of a virtual router. The virtual router does not exist; it represents the common target for routers that are configured to provide backup to each other. One of the routers is selected to be the active router and another to be the standby router, which assumes control of the group MAC address and IP address should the designated active router fail.

HSRP detects when the designated active router fails, and a selected standby router assumes control of the Hot Standby group’s MAC and IP addresses. A new standby router is also selected at that time. Devices running HSRP send and receive multicast UDP-based hello packets to detect router failure and to designate active and standby routers. When HSRP is configured on an interface, Internet Control Message Protocol (ICMP) redirect messages are disabled by default for the interface.

HSRP can be configured in Ethernet/Fast Ethernet/VLAN network without supporting token ring · token bus, FDDI and ATM LAN network.

49.2.2 HSRP protocol Configuration task list

- Enabling HSRP Protocol
- Configuring HSRP Group Property

49.2.3 HSRP protocol Configuration task

49.2.3.1 Enabling HSRP Protocol

To enable hsrp protocol in interface, you should configure the below command in interface configure model :

Command	Purpose
standby [<i>group-number</i>] ip [<i>ip-address</i> [<i>secondary</i>]]	Enable hsrp protocol

49.2.3.2 Configuring HSRP Group Property

To configure HSRP group property · you should configure one or more command list below in interface configure model:

Command	Purpose
standby [<i>group-number</i>] timershellotime <i>holdtime</i>	Configure HSRP timer parameter.
standby [<i>group-number</i>] mac-address <i>mac-address</i>	Configure HSRP group virtual mac address.
standby [<i>group-number</i>] priority <i>priority</i>	Configure hsrp priority level.(To vote in active/standby router)

standby [group-number] preempt [delaydelay]	Configure hsrp preempt. If local router's priority is larger than active router, local router should try to replace the active router. Configure hsrp preempt delay timer. Local router should replace active router after preempt delay timer.
standby [group-number] tracktype number [interface-priority]	Configure hsrp group tracking interface list. If the tracking interface is failed, HSRP priority value decreased.
standby [group-number] authenticationstring	Configure the HSRP group authentication string to authenticate hsrp packet validation.

49.2.4 Example of Hot Standby Configuration

The following is a typical HSRP configuration example. The host in network segment 171.16.6.0/24 access server 1 and server 2 through R1/R2/R3. R1 and R2 backups each other in network segment 172.16.2.0/24. Both R1 and R2 realize the load-share function.

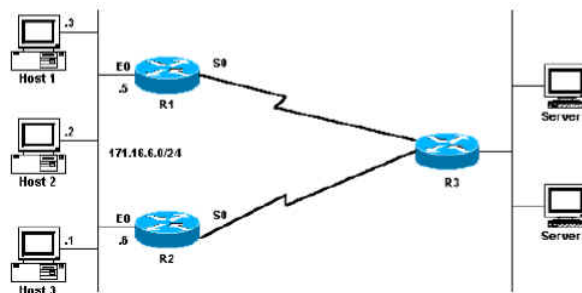

Figure 2-1 HSRP configuration

The following is R1 configuration:

First configure two HSRP groups on port Ethernet0, of which the virtual IP of group 1 is 171.16.6.100. The value of the default privilege level is 100, while the value of the privilege of group1 on R2 is 95. Therefore, R1 is the active router of group1. If the s0 protocol is down, the privilege of group 1 decreases to 90 by 10. In this case, the privilege of group1 on R2 is higher than that of group1 on R1. Because group1 on R2 has the occupation mechanism, group 1 on R2 then automatically switches to the active state and group1 of R1 switches to the standby state.

The virtual IP of group2 is 171.16.6.200 and the privilege of group 2 is 95. Because the default value of the privilege of group 2 on R2 is 100, group 2 of R2 is then the standby router.

R1 HSRP Configuration
Interface Ethernet0
ip address 171.16.6.5 255.255.255.0

```
standby 1 preempt
standby 1 ip 171.16.6.100 255.255.255.0
standby 1 trackl Serial0
standby 2 preempt
standby 2 ip 171.16.6.200 255.255.255.0
standby 2 track Serial0
standby 2 priority 95
```

The following is the R2 configuration:

Configure two HSRP groups on interface Ethernet 0. The virtual IP of group 1 is 171.16.6.100 and the privilege of group1 is 100, so R2 is the standby router of group1.

The virtual IP of group 2 is 171.16.6.200 and the default privilege of group2 is 100. Because the privilege of group2 on R2 is 95, R2 is then the active router of group2.

R2 HSRP Configuration
Interface Ethernet0
ip address 171.16.6.6 255.255.255.0
standby 1 preempt
standby 1 ip 171.16.6.100 255.255.255.0
standby 1 trackl Serial0
standby 1 priority 95
standby 2 preempt
standby 2 ip 171.16.6.200 255.255.255.0
standby 2 track Serial0

Then set the gateways of the host in network segment 172.16.6.0/24 to 172.16.6.100 and 172.16.6.200 respectively. In this case, the load balance then functions.

49.3 Configuring VRRP

49.3.1 VRRP Overview

The Virtual Router Redundant Protocol (VRRP) can take several routers as a router backup group, providing network users a virtual-gateway router. It is useful to users when the router detection protocol is not supported. This is because it cannot automatically switch to a new NMS router when the selected router is reinstalled or breaks down.

VRRP provides a virtual MAC address and a virtual IP which is shared by a group of VRRP-running routers. VRRP will select a router from this router group to server as a main router. The main router receives and forwards the packets whose destination address is the virtual MAC address of the backup group. When VRRP detects the invalidity of the main router, the VRRP routers will select one as a new main router to obtain the MAC and the IP of the backup group.

The VRRP-running main router transmits the Advertise packets based on the Sock Raw multicast, while the standby routers receive these packets. The standby routers can serve as the main router through their Timer out mechanism and the Preempt mechanism. You can configure multiple hot standby groups on an interface to fully use the router.

Currently VRRP supports Ethernet/Fast Ethernet/VLAN protocols, but it does not support the token ring and the token bus.

VRRP is designated by IETF VRRP working group which is defined in RFC2338.

49.3.1.1 VRRP Application

Line backup

You can back up a link through VRRP.

For example, if a node in a company or in a bank wants to connect the outside network through the VRRP group, another router will automatically take over the jobs when one router invalidates.

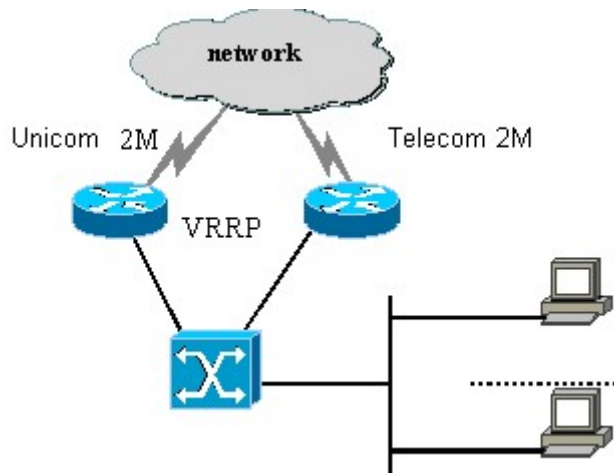

Figure 3-1 VRRP application

49.3.1.2 VRRP Terms

VRRP	Virtual Router Redundancy Protocol
VIP	Virtual IP
VMAC	Virtual MAC address
VRRP Router	A router which runs VRRP
Virtual Router	a VRRP group which is viewed by other parts in the network as a virtual router
IP Address Owner	A VRRP router that sets a real IP of an interface to VRRP VIP
VirtualRouter Master	Active router that forwards the data in the current VRRP group
Primary IP Address	An IP address selected from the addresses of an interface according to a certain regulation, which is normally the first IP

	address
<i>Virtual Router Backup</i>	A standby router which will be selected to serve as a data-forwarding router when the master router invalidates

49.3.2 VRRP Configuration Task List

- Enabling VRRP
- Configuring the time for vrrp
- Configuring the vrrp learning mode
- Configuring the description string for VRRP
- Configuring the privilege for VRRP hot backup
- Configuring the preemption mode
- Configuring the privilege for tracking other interfaces
- Configuring the authentication string
- Monitoring and maintaining VRRP

49.3.3 VRRP Configuration Tasks

49.3.3.1 Enabling VRRP

Command	Purpose
[no] vrrpgroup-number ip [ip-address] netmask [secondary]]	Enables or disables VRRP.

49.3.3.2 Configuring the Time of VRRP

Command	Purpose
[no] vrrpgroup-number timers advertise <1-255> <dsec<5-360>>	Sets the time of VRRP whose unit is second or 0.1 second.

49.3.3.3 Setting the VRRP Learning Mode

Command	Purpose
[no] vrrp group-number timers learn	Sets the VRRP learning mode.

49.3.3.4 Configuring the Description String of VRRP

Command	Purpose
[no] vrrpgroup-number description TEXT	Configures the description string for VRRP.

49.3.3.5 Configuring the Privilege for VRRP Hot Backup

Command	Purpose

[no] vrrp <i>group-number</i> priority<1-255>	Sets the hot standby privilege level in the VRRP router for selecting the primary router and the standby router.
--	--

49.3.3.6 Configuring the Preemption Mode

Command	Purpose
[no] vrrp <i>group-number</i> preempt [delay<1-254>]	Sets the preemption mode.

49.3.3.7 Configuring the Privilege for Tracking Other Ports

Command	Purpose
[no] vrrp <i>group-number</i> track <i>typenumber</i> [<i>interface-priority</i>]	Configures the privilege for tracking other ports, enabling the VRRP privilege to vary with the state change of the tracked port. When the tracked port invalidates, the VRRP privilege decreases; when the tracked port resumes effective, the VRRP privilege increases.

49.3.3.8 Configuring the Authentication String

Command	Purpose
[no] vrrp <i>group-number</i> authenticationstring	Selects an authentication string, which is used to authenticate other routers in the same group when the backup protocol packet exchanges.

49.3.3.9 Monitoring and Maintaining VRRP

Command	Purpose
show vrrp [<i>interfaceinterface-number</i>] brief detail	Displays the running state of the current VRRP.
debug vrrp [<i>interface</i> <i>interface-numbergroup-number</i>] all packets events errors	Debugs three kinds of VRRP events.

49.3.4 VRRP Configuration Example

In the following network topology, two subnets in a same network use their own gateways (gateway A and gateway B) respectively to access the Internet, but gateway A and gateway B are standby ones each other. When one gateway (one router) breaks down, the other will work for the two subnets.

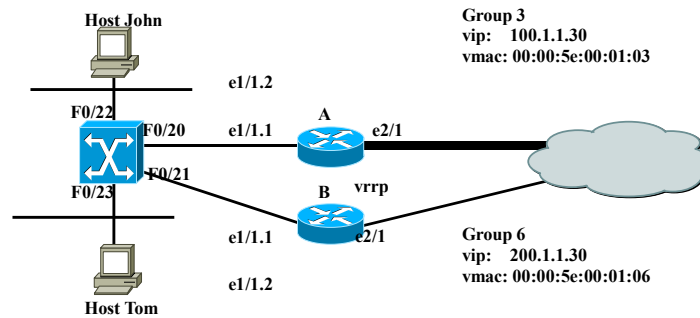

Figure 3-2 Simple VRRP application topology

The configuration is shown as follows:

Router A:

```

-----
interface Ethernet1/1.1
encapsulation dot1Q 2
ip address 100.1.1.5 255.255.255.0
vrrp 3 associate 100.1.1.30 255.255.255.0
    vrrp 3 priority 120
    vrrp 3 description line1-master
    vrrp 3 authentication line1pwd
vrrp 3 preempt
    vrrp 3 timers advertise dsec 15
-----

interface Ethernet1/1.2
encapsulation dot1Q 3
ip address 200.1.1.5 255.255.255.0
vrrp 6 associate 200.1.1.30 255.255.255.0
    vrrp 6 priority 110
    vrrp 6 description line2-backup
    vrrp 6 authentication line2pwd
vrrp 6 preempt
    vrrp 6 timers advertise dsec 15
-----

```

RouterB:

```
-----  
interface Ethernet1/1.2  
encapsulation dot1Q 2  
ip address 100.1.1.6 255.255.255.0  
vrrp 3 associate 100.1.1.30 255.255.255.0  
    vrrp 3 priority 110  
    vrrp 3 description line1-backup  
    vrrp 3 authentication line1pwd  
vrrp 3 preempt  
    vrrp 3 timers advertise dsec 15  
-----
```

```
interface Ethernet1/1.2  
encapsulation dot1Q 3  
ip address 200.1.1.6 255.255.255.0  
vrrp 6 associate 200.1.1.30 255.255.255.0  
    vrrp 6 priority 120  
    vrrp 6 description line2-master  
    vrrp 6 authentication line2pwd  
vrrp 6 preempt  
    vrrp 6 timers advertise dsec 15  
-----
```

SwitchA

```
-----  
interface FastEthernet0/20  
    switchport trunk vlan-allowed (2,3)  
!  
interface FastEthernet0/21  
    switchport trunk vlan-allowed (2,3)  
!  
interface FastEthernet0/22  
    switchport pvid 2  
!  
interface FastEthernet0/23  
    switchport pvid 3  
!  
interface VLAN2  
    ip addr 100.1.1.8 255.255.255.0  
    no ip directed-broadcast  
!
```



```
interface VLAN3  
ip addr 200.1.1.8 255.255.255.0  
no ip directed-broadcast
```

Chapter 50. Multicast Configuration

50.1 Multicast Overview

The chapter describes how to configure the multicast routing protocol. For the details of the multicast routing commands, refer to the part “Multicast Routing Commands”.

The traditional IP transmission allows only one host to communicate with a single host (unicast communication) or to communicate with all hosts (broadcast communication). The multicast technology allows one host to send message to some hosts. These hosts are called as group members.

The destination address of the message sent to the group member is a D-class address (224.0.0.0~239.255.255.255). The multicast message is transmitted like UDP. It does not provide reliable transmission and error control as TCP does.

The sender and the receiver make up of a multicast application. The sender can send the multicast message without joining in a group. However, the receiver has to join in a group before it receives the message from the group.

The relationship between group members is dynamic. The host can join in or leave a group at any time. There is no limitation to the location and number of the group member. If necessary, a host can be a member of multiple groups. Therefore, the state of the group and the number of group members varies with the time.

The router can maintain the routing table for forwarding multicast message by executing the multicast routing protocol such as PIM-DM and PIM-SM. The router learns the state of the group members in the directly-connected network segment through IGMP. The host can join in a designated IGMP group by sending the **IGMP Report** message.

The IP multicast technology is suitable for the one-to-multiple multimedia application.

50.1.1 Multicast Routing Realization

In the router software of our router, the multicast routing includes the following regulations:

- IGMP runs between the router and the host in the LAN, which is used to track the group member relationship.
- OLNK is a static multicast technology, which is used in the simple topology. It realizes the multicast forwarding and effectively saves CPU and bandwidth.
- PIM-DM, PIM-SM and DVMRP is dynamic multicast routing protocols. They run between routers and realizes the multicast forwarding by creating the multicast routing table.

The following figure shows the multicast protocols used in the IP multicast applications:

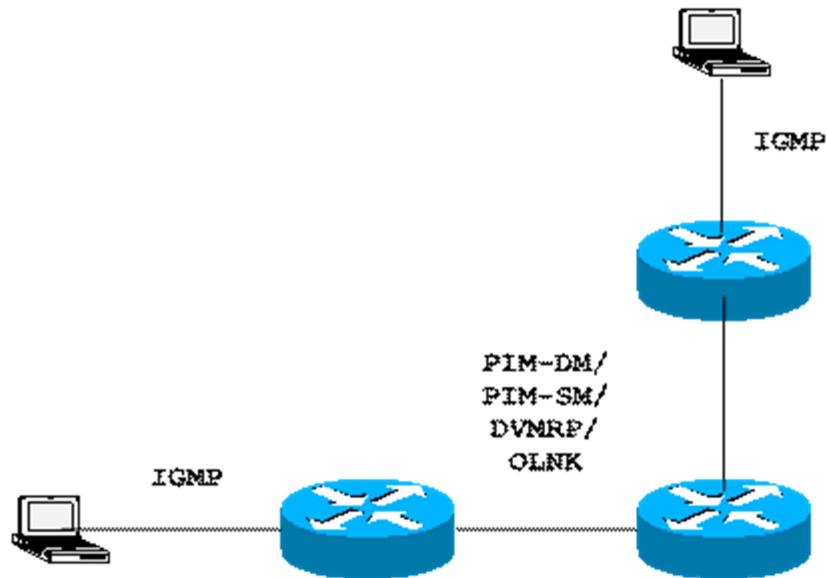

50.1.2 Multicast Routing Configuration Task List

50.1.2.1 Basic Multicast Configuration Task List

- Starting up the multicast routing (mandatory)
- Configuring TTL threshold (optional)
- Canceling rapid multicast forwarding (optional)
- Configuring static multicast route (optional)
- Configuring multicast boundary (optional)
- Configuring multicast helper (optional)
- Configuring Stub multicast route (optional)
- Monitoring and maintaining multicast route (optional)

50.1.2.2 IGMP Configuration Task List

- Modifying the current version of IGMP
- Configuring the IGMP query interval
- Configuring IGMP Querier interval
- Configuring the maximum response time of IGMP
- Configuring the query interval of the last IGMP group member
- Static IGMP configuration
- Configuring the IGMP **Immediate-leave** list

50.1.2.3 PIM-DM Configuration Task List

- Regulating the timer
- Designate the PIM-DM version
- Configuring the state refreshment

- Configuring the filtration list
- Setting the DR priority
- Clearing (S,G) information

50.1.2.4 PIM-SM Configuration Task List

- Configuring static RP
- Configuring standby BSR
- Configuring standby RP
- Displaying PIM-SM multicast routing
- Clearing multicast routes learned by PIM-SM

50.2 Basic Multicast Routing Configuration

50.2.1 Starting up Multicast Routing

To allow the router software to forward the multicast message, you must start up the multicast routing. Run the following command in global configuration mode to start up the multicast message forwarding:

Command	Purpose
ip multicast-routing	Starts up the multicast routing.

50.2.2 Starting up the Multicast Function on the Port

When the multicast routing protocol runs on a port, the IGMP is activated on the port. The multicast routing protocols include OLNK, PIM-DM, PIM-SM and DVMRP. Only one multicast routing protocol is allowed to run on the same port. When the router connects multiple multicast domains, different multicast protocols can be run on different ports.

Although the router software can function as the multicast boundary router (MBR). If possible, do not simultaneously run multiple multicast routing protocols on the same router for some multicast routing protocols may be badly affected. For example, when PIM-DM and BIDIR PIM-SM simultaneously run, confusion is to occur.

50.2.2.1 Starting up PIM-DM

Run the following command to run PIM-DM on a port and then activate the multicast dense mode function:

Command	Purpose
ip pim-dm	Enters the port where PIM-DM is running and then activates PIM-DM multicast routing process in port configuration mode.

50.2.2.2 Starting up PIM-SM

To run PIM-DM on a port and activate the PIM-DM multicast, perform the following operation:

Command	Purpose
ip pim-sm	Enters a port where PIM-SM needs to run and then activates the PIM-SM multicast routing process in port configuration mode.

50.2.3 Configuring TTL Threshold

Run the command **ip multicast ttl-threshold** to configure the TTL threshold of the multicast message that is allowed to pass the port. Run the command **no ip multicast ttl-threshold** to use the default threshold value 1.

Command	Purpose
ip multicast ttl-threshold <i>ttl-value</i>	Configures the TTL threshold on the port.

Example

The following example shows how the administrator configures the TTL threshold on a port:

```
interface ethernet 1/0
ip multicast ttl-threshold 200
```

50.2.4 Cancelling Rapid Multicast Forwarding

Run the command **ip multicast mroute-cache** to configure the rapid multicast forwarding function on a port. Run the command **no ip multicast mroute-cache** to cancel the rapid multicast forwarding function.

Command	Purpose
ip multicast mroute-cache	Enables the rapid multicast forwarding function on a port.

Example

The following example shows how the administrator cancels the rapid multicast forwarding function on a port:

```
interface ethernet 1/0
no ip mroute-cache
```

50.2.5 Configuring Static Multicast Route

The static multicast route allows that the multicast forwarding path is different from the unicast path. RPF check is performed when the multicast message is forwarded. The actual port receiving the message is the expected receiving port. That is, the port is the next-hop port of the unicast route that reaches the sender. If the unicast topology is same to the multicast topology, RPF check is reasonable. In some cases, the unicast path requires to be different from the multicast path.

Take the tunnel technology as an example. When a router in a path does not support the multicast protocol, the resolution is to configure the GRE tunnel between two routers. In the following figure, each unicast router supports only the unicast message; each multicast router supports only the multicast message. The source host sends the multicast message to the destination host through MR1 and MR2. MR2 forwards the multicast message only when it is received through the tunnel. When the destination host sends the unicast message to the source host, the tunnel is also used. When the tunnel technology is adopted, the message transmission speed is slower than that of the direct message transmission.

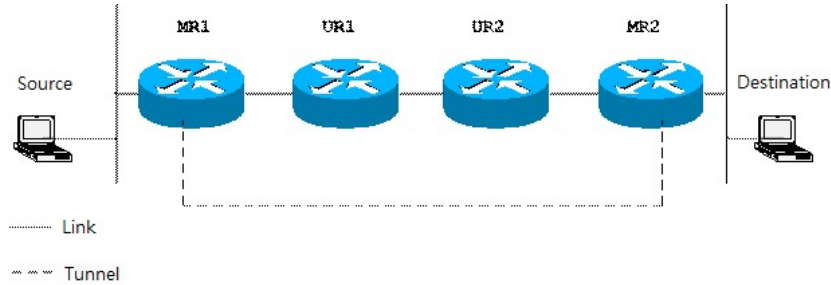

After the static multicast routing is configured, the router can perform the RPF check according to the configuration information. The RPF check is not based on the unicast routing table any more. Therefore, the multicast message goes through the tunnel, while the unicast message does not go through the tunnel. The static multicast route only exists in the local place. It will not be announced or forwarded.

Run the following command in global configuration mode to configure the static multicast route:

Command	Purpose
ip mroute <i>source-address mask</i> <i>rpf-address</i> <i>type</i> <i>number</i> [distance]	Configures the static multicast route.

50.2.6 Configuring IP Multicast Boundary

Run the command **ip multicast boundary** to configure the multicast boundary for the port. Run the command **no ip multicast boundary** to cancel the configured boundary. The commands used in the second configuration will replace the commands used in the first configuration.

Command	Purpose
ip multicast boundary <i>access-list</i>	Configures the multicast boundary for the port.

Example

The following example shows how to configure the management boundary for a port:

```
interface ethernet 0/0
ip multicast boundary acl
ip access-list standard acl
permit 192.168.20.97 255.255.255.0
```

50.2.7 Configuring IP Multicast Rate Control

Run the command **ip multicast rate-limit** to limit the rate of receiving and sending the multicast message in a source/group range. Run the command **no ip multicaste-rate-limit** to cancel the rate limitation.

Run the following command to limit the input rate of a multicast flow to n kbps.

Command	Purpose
ip multicast rate-limit in group-list <i>access-list1</i> source-list <i>access-list2</i> nkbps	Configures the maximum input rate limitation of the multicast flow in a certain range.

Run the following command to limit the output rate of a multicast flow to n kbps

Command	Purpose
ip multicast rate-limit <i>outgroup-list</i> <i>access-list1</i> source-list <i>access-list2</i> kbps	Configures the maximum output rate limitation of the multicast flow in a certain range.

50.2.8 Configuring IP Multicast Helper

Run the command **ip multicast helper-map** to use the multicast route to connect two broadcast networks in the multicast network. Run the command **no ip multicast helper-map** to cancel the command.

Command	Purpose
interface <i>type number</i>	Enters the interface configuration mode.
ip multicast helper-map broadcast <i>group-address</i> <i>access-list</i>	Configures the command ip multicast helper to convert the broadcast message to the multicast message.
ip directed-broadcast	Allows the directional broadcast.
ip forward-protocol [<i>port</i>]	Configures the port number allowing to forward the message.

On the last-hop router connecting the destination broadcast network, perform the following operations:

Command	Purpose
interface <i>type number</i>	Enters the interface configuration mode.
ip directed-broadcast	Allows the directional broadcast.
ip multicast helper-map <i>group-address</i> <i>broadcast-address</i> <i>access-list</i>	Configures the command ip multicast helper to convert the multicast message to the broadcast message.
ip forward-protocol [<i>port</i>]	Configures the port number allowing to forward the message.

Example

The following example shows how to configure the command `ip multicast helper`.

The configuration of the router is shown in the following figure. Configure the command `ip directed-broadcast` on the `e0` port of the first-hop router to handle the directional message. Configure `ip multicast helper-map broadcast 230.0.0.1 testacl1`, allowing to convert the UDP broadcast message with port number 4000 that is sent from the source address `192.168.20.97/24` to the multicast message with the destination address `230.0.0.1`.

Configure the command `ip directed-broadcast` on the `e1` port of the last-hop router to handle the directional message. Configure `ip multicast helper-map 230.0.0.1 172.10.255.255 testacl2`, allowing to convert the multicast message with port number 4000 and the destination address `230.0.0.1` that is sent from the source address `192.168.20.97/24` to the broadcast message with the destination address `172.10.255.255`.

In the first-hop router connecting the source broadcast network, perform the following operations: (the router is configured on the VLAN port)

```
interface ethernet 0
ip directed-broadcast
ip multicast helper-map broadcast 230.0.0.1 testacl
ip pim-dm
!
ip access-list extended testacl permit udp 192.168.20.97 255.255.255.0 any
ip forward-protocol udp 4000
```

In the last-hop router connecting the destination broadcast network, perform the following operations:

```
interface ethernet 1
ip directed-broadcast
ip multicast helper-map 230.0.0.1 172.10.255.255 testacl2
ip pim-dm
!
ip access-list extended testacl2 permit udp 192.168.20.97 255.255.255.0 any
ip forward-protocol udp 4000
```

50.2.9 Configuring Stub Multicast Route

Run the commands `ip igmp helper-address` and `ip pim-dm neighbor-filter` to configure the Stub multicast route.

On the port where the stub router and the host are connected, perform the following operations:

Command	Purpose
<code>interface type number</code>	Enters the interface configuration mode.
<code>ip igmp helper-address destination-address</code>	Configures the command <code>ip igmp helper-address</code> to forward the multicast message to the central router.

On the port where the central router and the stub router are connected, perform the following operations:

Command	Purpose
interface <i>type number</i>	Enters the interface configuration mode.
ip pim neighbor-filter <i>access-list</i>	Filters all pim messages on the stub router.

Example

The configuration of router A and B is shown as follows:

Stub Router A Configuration

ip multicast-routing

ip pim-dm

ip igmp helper-address 10.0.0.2

Central Router B Configuration

ip multicast-routing

ip pim-dm

ip pim-dm neighbor-filter stubfilter

ip access-list stubfilter

deny 10.0.0.1

50.2.10 Monitoring and Maintaining Multicast Route

50.2.10.1 Clearing the multicast cache and the routing table

If special caches or the routing table is invalid, you need to clear its content. Run the following commands in management mode:

Command	Purpose
clear ip igmp group [<i>type number</i>] [<i>group-address</i> <cr>]	Clears the items in the IGMP cache.
clear ip mroute [* <i>group-address</i> <i>source-address</i>]	Clears the items in the multicast routing table.

50.2.10.2 Displaying the multicast routing table and system statistics information

The detailed information about the IP multicast routing table, cache or database helps to judge how the resources are used and to resolve network problems.

Run the following commands in management mode to display the statistics information about the multicast route:

Command	Purpose
show ip igmp groups [<i>type number</i> <i>group-address</i>] [<i>detail</i>]	Displays the information about the multicast group in the IGMP cache.
show ip igmp interface [<i>type number</i>]	Displays the IGMP configuration information on the interface.

show ip mroute mfc	Displays the multicast forwarding cache.
show ip rpf [ucast mstatic pim-dm pim-sm dvmrp] <i>source-address</i>	Displays the RPF information.

50.3 IGMP Configuration

50.3.1 Overview

50.3.1.1 IGMP

Internet Group Management Protocol (IGMP) is a protocol used to manage multicast group members. IGMP is an asymmetric protocol, containing the host side and the switch side. At the host side, the IGMP protocol regulates how the host, the multicast group member, reports the multicast group it belongs to and how the host responds to the query message from the switch. At the switch side, the IGMP protocol regulates how the IGMP-supported switch learns the multicast group member ID of the hosts in the local network and how to modify the stored multicast group member information according to the report message from the host. Since our switches support the IGMP Router protocol, the multicast routing protocol can be provided with the information about the multicast group members in the current network and the switch decides whether to forward the multicast message. In a word, to enable the switch support the multicast process of the IP message, the switch need be configured to support the multicast routing protocol and the IGMP Router protocol. Currently, MY COMPANY' switches support the IGMP Router protocol and version 3 IGMP, the latest version.

There is no independent startup commands for IGMP. The function of the IGMP-Router protocol is started up through the multicast routing protocol.

50.3.1.2 OLNK

Strictly speaking, the IGMP only-link protocol (OLNK) is not a multicast routing protocol because it has no interaction process as other protocols. However, in some special cases, running OLNK in the simple topology will get nice results. Similar to the PIM-DM protocol which also has no negotiation process, OLNK can handle the change of IGMP group members and promptly adjust the RPF interface according to the topology change. In this way, OLNK ensures the multicast forwarding and prevents the control messages of the multicast routing protocol from occupying the bandwidth.

50.3.2 IGMP Configuration

The commands to configure the attributes of the IGMP-Router mainly are the commands to adjust the IGMP parameters. The following is to describe these commands. For details about these commands, refer to explanation documents relative to the IGMP commands.

50.3.2.1 Changing Current IGMP Version

Up to now, the IGMP protocol has three formal versions. The corresponding RFCs are RFC1112, RFC2236

and RFC3376. IGMP V1 supports only the function to record the multicast group members. IGMP V2 can query the designated multicast group member, generates the leave message when an IGMP host leaves a multicast group, and shortens the change delay of the group member. IGMP V3 has additional functions to update and maintain the multicast group member IDs which correspond to the source host addresses. The IGMP Router protocol of IGMP V3 is fully compatible with the host side of IGMP V1 and IGMP V2. MY COMPANY's switch software supports the IGMP Router protocols of the three IGMP versions.

You can configure the IGMP-Router function at different interfaces (the multicast routing protocol configured on different interfaces can start up the IGMP-Router function) and different versions of IGMP can be run on different interfaces.

Note that a multicast switch can start up the IGMP-Router function on only one of the ports that connect the same network.

Run the following command in interface configuration mode to change the version of the IGMP-Router protocol on a port:

Command	Purpose
ip igmp version <i>version_number</i>	Changes the IGMP version running on the current port.

50.3.2.2 Configuring IGMP Query Interval

No matter what version number of the current IGMP-Router protocol is, the multicast switch can send the IGMP General Query message every a certain time on the port where the IGMP-Router function is started. The transmission address is 224.0.0.1. The purpose of the multicast switch is to get the report message from the IGMP host and therefore know which multicast group each IGMP host in the network belongs to. The interval to send the General Query message is called as IGMP Query Interval. If the parameter IGMP Query Interval is set to a big value, the switch cannot immediately receive the information about which multicast group the current IGMP host belongs to. If the parameter IGMP Query Interval is set to a small value, the flow of the IGMP message is to increase in the current network.

Run the following command in interface configuration mode to modify the IGMP query interval on a port:

Command	Purpose
ip igmp query-interval <i>time</i>	Modifies the IGMP query interval on the current interface (unit: second).

50.3.2.3 Configuring IGMP Querier Interval

As to version 2 and version 3 of the IGMP-Router protocol, if another switch that runs the IGMP-Router protocol exists in the same network, you need to choose a querier. Querier stands for a switch that can send the query message (In fact, it is a port of the switch where the IGMP-Router protocol is enabled). Normally, one network has only one querier, that is, only one switch sends the IGMP Query message. There is no querier choice for IGMP-Router V1 because the multicast routing protocol decides which switch to send the IGMP Query message in IGMP-Router V1.

IGMP-Router V2 and IGMP-Router V3 have the same querier choice mechanism, that is, the switch with the

minimum IP address is the querier in the network. The switch that is not the querier needs to save a clock to record the existence of the querier. If the clock times out, the non-querier switch turns to be the querier until it receives the IGMP Query message from the switch with a smaller IP address.

For IGMP-Router V2, you can configure other querier intervals using the following command:

Command	Purpose
ip igmpquerier-timeout <i>time</i>	Configures the interval for other queriers (unit: second).

For IGMP-Router V1, the interval of other queriers is useless. For IGMP-Router V3, the interval cannot be configured because it is decided by the protocol itself.

50.3.2.4 Configuring Maximum IGMP Response Time

For IGMP-Router V2 and IGMP-Router V3, special data field in the transmitted IGMP General Query message regulates the maximum response time of the IGMP host. That is, the IGMP host has to send the response message before the regulated maximum response time expires, indicating that the General Query message is received. If the maximum response time is set to a big value, the change of multicast group members delays. If the maximum response time is set to a small value, the flow of the IGMP message will be increased in the current network.



The maximum IGMP response time must be shorter than the IGMP query interval. If the value of the maximum response time is bigger than the query interval, the system will automatically set the maximum response time to **query-interval – 1**.

For IGMP-Router V2 and IGMP-Router V3, run the following command in interface configuration mode to set the maximum IGMP response time:

Command	Purpose
ip igmp query-max-response-time <i>time</i>	Configures the maximum IGMP response time (unit: second).

For IGMP-Router V1, the maximum IGMP response time is decided by the protocol itself. Therefore, the previous command is useless to IGMP-Router V1.

50.3.2.5 Configuring IGMP Query Interval for the Last Group Member

For IGMP-Router V2 and IGMP-Router V3, When the Group Specific Query message for a specific multicast group is sent, the query interval of the last group member will be used as the maximum response time of the host. That is, the IGMP host has to send the response message before the maximum response time of the last group member expires, indicating that the Group Specific Query message is received. If the IGMP host finds that it need not respond to the query message, it will not respond to the message after the interval. In this case, the multicast switch is to update the saved multicast group member information. If the query interval of the last group member is set to a big value, the change of the multicast group member delays. If the query interval of the last group member is set to a small value, the flow of the IGMP message is to increase in the current network.

For IGMP-Router V2 and IGMP-Router V3, run the following command in interface configuration mode to configure the IGMP query interval of the last group member:

Command	Purpose
ip igmp last-member-query-interval <i>time</i>	Configures the IGMP query interval of the last group member (unit: ms).

The previous command is useless for IGMP-Router V1.

50.3.2.6 Static IGMP Configuration

Besides the functions regulated by the IGMP-Router protocol, BODCOM's switches support the static multicast group configuration on the port. For the IGMP host, its multicast group member relationship may vary. Suppose the IGMP host only belongs to the multicast group **group1**, it receives the multicast message from and sends the multicast message to the multicast group **group1**. After a period of time, it may belong to the multicast group **group2**, and receives the multicast message from and sends the multicast message to the multicast group **group2**. After another period of time, the IGMP host may not belong to any multicast group. Therefore, the multicast group assignment information varies.

Different the above "dynamic multicast group", if a port is configured to belong to a static multicast group, the multicast routing protocol then takes the port as one that always receives and sends the multicast message of the multicast group. To be better compatible with IGMP-Router V3, the static multicast group can be configured to receive the multicast message from the designated source address, that is, the source-filter function is added when the multicast message is received.

Run the following command in interface configuration mode to configure the static multicast group for a port:

Command	Purpose
ip igmp static-group { * <i>group-address</i> } { <i>includesource-address</i> <cr> }	Configures the static multicast group attribute for a port.

50.3.2.7 Configuring the IGMP Immediate-leave List

If IGMP V2 is started up on a port of the switch and the network that the port connects has only one IGMP host, you can realize the Immediate Leave function of the IGMP host by configuring the **IGMP Immediate-leave** list. According to the regulations of IGMP V2, when a host leaves a specific multicast group, the host will send the Leave message to all multicast switches. After receiving the Leave message, the multicast switches send the Group Specific message to confirm whether any multicast message to be received from or sent to the multicast group by the host exists on the port. If the Immediate Leave function is configured, no message need be interacted between the IGMP host and the multicast switch, the change of the multicast group member IDs will not be delayed.



The command can be configured both in global configuration mode and in interface configuration mode. The priority of the command configured in global configuration mode is higher than that configured in interface configuration mode. If the command is first configured in global configuration mode, the command configured in

interface configuration mode will be omitted. If the command is first configured in interface configuration mode, the command configured in global configuration mode will delete the command configured in interface configuration mode.

For IGMP-Router V2, run the following command in interface configuration mode to configure the IGMP Immediate-leave list:

Command	Purpose
ip igmp immediate-leave group-list/list-name	Configures the access list that realizes the function to immediately leave the multicast group for the IGMP host.
ip access-list standard list-name	Creates a standard IP access list named list-name .
permit source-address	Configures the IP address for the IGMP host that will realize the immediate-leave function in standard access-list configuration mode.

The previous command is invalid to IGMP-Router V1 and IGMP-Router V3.

50.3.3 IGMP Characteristic Configuration Example

All configurations about the IGMP characteristics are performed in VLAN port.

50.3.3.1 Example for changing the IGMP version

The IGMP-Router protocol of latter version is compatible with the IGMP host of low version, but cannot be compatible with the IGMP-Router protocol of the earlier version. Therefore, if, there are switches running the IGMP-Router protocol of the earlier version in the current network, you need to change the IGMP-Router protocol of latter version to the IGMP-Router protocol of earliest version in the same network segment. Suppose the administrator knows that switches running IGMP-Router V1 and IGMP-Router V2 exist in a network that the local switch connects, the administrator needs to change the version of the IGMP-Router protocol from version 2 to version 1 on a port of the switch that runs IGMP-Router V2.

```
interface ethernet 1/0
ip igmp version 1
```

50.3.3.2 IGMP query interval configuration example

The following example shows how to modify the IGMP query interval to 50 seconds on the interface **ethernet 1/0**:

```
interface ethernet 1/0
ip igmp query-interval 50
```

50.3.3.3 IGMP Querier interval configuration example

The following example shows how to modify the IGMP Querier interval to 100 seconds on the interface **ethernet 1/0**:

```
interface ethernet 1/0
ip igmp querier-timeout 100
```

50.3.3.4 Maximum IGMP response time example

The following example shows how to modify the maximum IGMP response time to 15 seconds on the interface **ethernet 1/0**:

```
interface ethernet 1/0
ip igmp query-max-response-time 15
```

50.3.3.5 Example for configuring IGMP query interval for the last group member

The following example shows how to modify the IGMP query interval of the last group member to 2000 ms on the interface **ethernet 1/0**:

```
interface ethernet 1/0
ip igmp last-member-query-interval 2000
```

50.3.3.6 Static IGMP configuration example

The configuration command of the static multicast group can define different classes of static multicast groups by adopting different parameters. The following examples shows the results of running different command parameter.

```
interface ethernet 1/0
ip igmp static-group *
```

The previous configuration command configures all static multicast groups on the interface **ethernet 1/0**. The multicast routing protocol is to forward all IP multicast messages to the interface **ethernet 1/0**.

```
interface ethernet 1/0
ip igmp static-group 224.1.1.7
```

The previous configuration command configures the static multicast group 224.1.1.7 on the interface **ethernet 1/0**, that is, the interface belongs to the multicast group 224.1.1.7. The multicast routing protocol is to forward all IP multicast messages that are finally sent to the multicast group 224.1.1.7 to the interface **ethernet 1/0**.

```
interface ethernet 1/0
ip igmp static-group 224.1.1.7 include 192.168.20.168
```

The previous configuration command configures the static multicast group 224.1.1.7 on the interface **ethernet 0/0**, and defines source-filter of the multicast group as 192.168.20.168. That is, the interface belongs to the multicast group 224.1.1.7, but it only receives the IP multicast messages from 192.168.20.168. The multicast routing protocol is to forward IP multicast messages that are received from 192.168.20.168 and finally sent to

the multicast group 224.1.1.7 to the interface ethernet 0/0.

Run the following command in interface configuration mode to receive the IP multicast message that is from 192.168.20.169 and finally sent to the multicast group 224.1.1.7:

```
ip igmp static-group 224.1.1.7 include 192.168.20.169
```

The previous command can be executed for many times to define different source addresses.



In a multicast group, the multicast group information cannot be simultaneously configured both for a specific source address and for all source addresses. The command used in the later configuration will be omitted. For example, If you run the command **ip igmp static-group 224.1.1.7 include 192.168.20.168** after the command **ip igmp static-group 224.1.1.7** is executed, the command **ip igmp static-group 224.1.1.7 include 192.168.20.168** will be omitted.

50.3.3.7 IGMP Immediate-leave list configuration example

The following example shows how to set the access list to **imme-leave** on the interface ethernet 1/0 with the **immediate-leave** function and to add the IP address 192.168.20.168 of the IGMP host to the access list. The configuration ensures that the IGMP host with IP address 192.168.20.168 realizes the **immediate-leave** function.

```
interface ethernet 1/0
ip igmp immediate-leave imme-leave
exit
ip access-list standard imme-leave
permit 192.168.20.168
```

50.4 PIM-DM Configuration

50.4.1 PIM-DM Introduction

Protocol Independent Multicast Dense Mode (PIM-DM) is a multicast routing protocol in dense mode. By default, when the multicast source starts to send the multicast data, all network nodes in the domain receive the data. Therefore, PIM-DM forwards the multicast packets in broadcast-pruning mode. When the multicast source starts to send data, the switches alongside forward the multicast packets to all PIM-activated interfaces except the RPF interface. In this way, all network nodes in the PIM-DM domain can receive these multicast packets. To finish the multicast forwarding, the switches alongside need create the corresponding multicast routing item (S,G) for group G and its source S. The routing item (S,G) includes the multicast source address, multicast group address, incoming interface, outgoing interface list, timer and logo.

If there is no multicast group member in a certain network segment, PIM-DM will send the pruning information, prune the forwarding interface connecting the network segment and then establish the pruning state. The pruning state corresponds to the timeout timer. When the timer times out, the pruning state turns to be the forwarding state again and the multicast data can be forwarded along these branches. Additionally, the

pruning state contains information about the multicast source and the multicast group. When the multicast group member appears in the pruning area, PIM-DM actively sends the graft message to the upper field without waiting for the pruning state of the upper field to time out, turning the pruning state to the forwarding state.

As long as source S still sends information to group G, the first-hop switch will periodically send the refreshing information of the routing item (S,G) to the nether original broadcast tree to finish refreshing. The state refreshing mechanism of PIM-DM can refresh the state of the downstream, ensuring that the pruning of the broadcast tree does not time out.

In the multi-access network, besides the DR selection, PIM-DM also introduces the following mechanisms:

- Use the assertion mechanism to select the unique forwarder to prevent the multicast packet from being repeatedly forwarded.
- Use the add/prune restraint mechanism to reduce redundant add/prune information.
- Use the pruning deny mechanism to deny improper pruning actions.

In the PIM-DM domain, the switches that run PIM-DM periodically send the Hello information to achieve the following purposes:

- Discover neighboring PIM switches.
- Judge leaf networks and leaf switches.
- Select the designated router (DR) in the multi-access network.

To be compatible with IGMP v1, PIM-DM is in charge of the DR choice. When all PIM neighboring routers on the interface support DR Priority, the neighboring router with higher priority is selected as the DR. If the priority is the same, the neighboring router with the maximum interface IP value is selected as the DR. If the priority is not shown in the Hello message of multiple routers, the router whose interface has the biggest IP value is selected as the DR.

The PIM-DM v2 of DBCOM's switches supports the neighbor filtration list, CIDR, VLSM and IGMP v1-v3.

50.4.2 Configuring PIM-DM

50.4.2.1 Modifying Timer

The routing protocol adopts several timers to judge the transmission frequency of Hello message and state-refresh control message. The interval to transmit the Hello message affects whether the neighbor relationship can correctly created.

Run the following commands in switch configuration mode to regulate the timer:

Command	Purpose
ip pim-dm hello-interval	Sets the interval (unit: second) to send the Hello message from the interface and the neighbor.
lppim-dm state-refresh rignation-interval	For the first-hop switch directly connecting the source, the interval to send the state-refresh message is only valid to the configurations at the

	upstream ports. For the following switches, the interval is the period to receive and handle the state-refresh message.
--	---

50.4.2.2 Configuring State-Refresh

The state-refresh control information of the PIM-DM is forwarded in management mode by default. The configuration commands in interface configuration mode are effective only to the configurations at the upstream ports when the first-hop switch directly connecting the source sends the state-refresh message periodically. For the following switches, the interval is the period to receive and handle the state-refresh message.

Command	Purpose
no ip pim-dm state-refresh disable	Allows to send and receive the state-refresh message on the port.
ip pim-dm state-refresh origination-interval	Configures the interval to send and receive the state-refresh message on the port.

50.4.2.3 Configuring Filtration List

PIM-DM does not set the filtration list by default. The referred filtration list includes the neighbor filtration list and the multicast boundary filtration list. The filtration list requires to be configured in interface configuration mode.

To forbid a switch or switches at a network segment to join in the PIM-DM negotiation, the neighbor filtration list need be configured. To forbid or permit some groups to pass the local region, the multicast boundary filtration list need be configured.

Command	Purpose
ip pim-dm neighbor-filter	Configures the neighbor filtration list.
ip multicast boundary	Configures the multicast boundary filtration list.

50.4.2.4 Setting DR Priority

To be compatible with IGMP v1, the DR choice is required. By default, the priority of the DR is set to **1**. When all PIM neighboring routers on the interface support DR Priority, the neighboring router with higher priority is selected as the DR. If the priority is the same, the neighboring router with the maximum interface IP value is selected as the DR. If the priority is not shown in the Hello message of multiple routers, the router whose interface has the biggest IP value is selected as the DR.

Run the following command in interface configuration mode:

Command	Purpose

ip pim-dm dr-priority	Configures the priority for the local DR on the designated port.
------------------------------	--

50.4.2.5 Clearing Item (S,G)

Normally, item (S,G) in the local MRT or the statistics value of the multicast message number forwarded through item (S,G) need be cleared. Run the following commands in management mode.

Command	Purpose
clear ip mroute pim-dm {* <i>group</i> [<i>source</i>]}	Clears the item (S,G) in the local MRT. The operation is to delete all or part items of the local multicast routing table. Multicast message forwarding may be affected. The command is used to delete only the (S,G) items created by the PIM-DM multicast routing protocol on the upstream ports.
clear ip pim-dm interface	Resets the statistics value of multicast message forwarded by (S,G) on the PIM-DM port. The command is used to reset only the (S,G) items created by the PIM-DM multicast routing protocol on the upstream ports.

50.4.3 PIM-DM State-Refresh Configuration Example

Refer to section 4.2.2 “Configuring State-Refresh”.

50.5 Configuring PIM-SM

50.5.1 PIM-SM Introduction

Protocol Independent Multicast Sparse Mode (PIM-SM) is a multicast routing protocol in sparse mode. In the PIM-SM domain, the switches that run PIM-SM periodically send the Hello information to achieve the following purposes:

- Discover neighboring PIM-SM switches.
- Select the designated router (DR) in the multi-access network.

As shown in the following figure, the DR sends the join/prune message to the directly-connected group members at the direction of multicast distribution tree, or sends the data of the directly-connected multicast source to the multicast distribution tree.

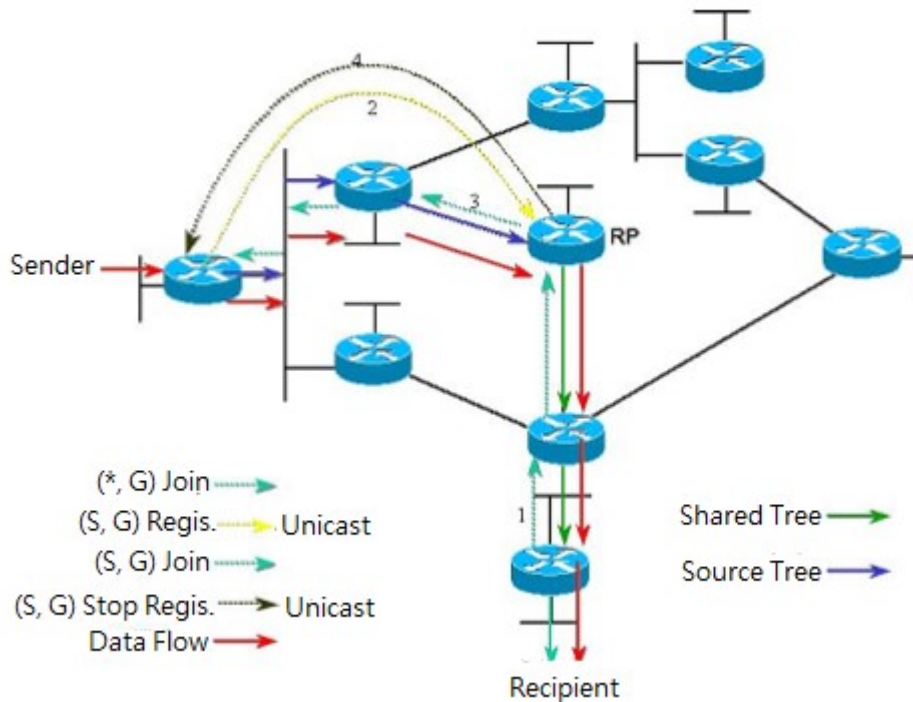

Figure 5-1 Join-in mechanism of PIM-SM

PIM-SM forwards the multicast packet by creating the multicast distribution tree. The multicast distribution tree can be classified into two groups: Shared Tree and Shortest Path Tree. Shared Tree takes the RP of group G as the root, while Shortest Path Tree takes the multicast source as the root. PIM-SM creates and maintains the multicast distribution tree through the displayed join/prune mode. As shown in Figure 5-1, when the DR receives a Join message from the receiving side, it will multicast a (*, G)-join message at each hop towards the RP of group G to join in the shared tree. When the source host sends the multicast message to the group, the packet of the source host is packaged in the registration message and unicast to the RP by the DR; The RP then sends the unpackaged packet of the source host to each group member along the shared tree; The RP sends the (S,G)-join message to the first-hop switch towards the source's direction to join in the shortest path tree of the source; In this way, the packet of the source will be sent to the RP along the shortest path tree without being packaged; When the first multicast data arrives, the RP sends the registration-stop message to the DR of the source and the DR stops the registration-packaged process. Afterwards, the multicast data of the source is not packaged any more, but it will be sent to the RP along the shortest path tree of the source and then sent to each group member by the RP along the shared tree. When the multicast data is not needed, the DR multicasts the Prune message hop by hop towards the RP of group G to prune the shared tree.

PIM-SM also deals with the RP choice mechanism. One or multiple candidate BSRs are configured in the PIM-SM domain. You can select a BSR among candidate BSRs according to certain regulations. Candidate RPs are also configured in the PIM-SM domain. These candidate RPs unicast the packets containing RP's address and multicast groups to the BSR. The BSR regularly generates the Bootstrap message containing a series of candidate RPs and corresponding group addresses. The Bootstrap message is sent hop by hop in the whole domain. The switch receives and stores the Bootstrap message. After the DR receives a report

about a group member’s relationship from the directly-connected host, if the DR has no the routing item of the group, the DR will map the group address to a candidate RP through the Hash algorithm. The DR then multicasts the Join/prune message hop by hop towards the RP. Finally, the DR packages the multicast data in the registration message and unicasts it to the RP.

50.5.2 Configuring PIM-SM

50.5.2.1 Starting up PIM-SM

Run the following command to run PIM-SM on the interface to activate the multicast function in sparse mode:

Command	Purpose
ip pim-sm	Enters the interface where PIM-SM needs to be run and activates the PIM-SM multicast routing process in interface configuration mode.

50.5.2.2 Configuring Static RP

If the network scale is small, you can configure the static RP to use PIM-SM. The RP configuration of all routers in the PIM-SM domain must be same, ensuring the PIM-SM multicast route is correct.

If some router in the PIM-SM domain runs the BSR, the RP check follows the order: the static RP with override configured is preferred. If the override is not configured for the static RP, the RP in the RP mapping list distributed by the BSR is preferred.

Run the following command in global configuration mode:

Command	Purpose
ip pim-sm rp-address rp-add [override]acl-name]	Configures the static RP for the local switch.
no ip pim-sm rp-address rp-add	

50.5.2.3 Configuring Candidate BSR

The configuration of the candidate RP can generate the unique global BSR in the PIM-SM domain. The global BSR collects and distributes the RP in the domain, ensuring the RP mapping is unique.

Run the following command in global configuration mode:

Command	Purpose
ip pim-sm bsr-candidate type number [hash-mask-length] [priority]	Configures the local switch as the candidate BSR, and competes the global BSR by learning the BSM message.
no ip pim-sm bsr-candidate type number	

50.5.2.4 Configuring Candidate RP

Configure the candidate RP to enable it to be sent to the BSR periodically and then be diffused to all PIM-SM

routers in the domain, ensuring the RP mapping is unique.

Run the following command in global configuration mode:

Command	Purpose
ip pim-sm rp-candidate [typenumber] [interval group-list acl-name] no ip pim-sm rp-candidate [typenumber]	Configures the local switch as the candidate RP. After the candidate RP is configured, it will be sent to the BSR periodically. The BSR then broadcasts all PIM-SM routers in the PIM-SM domain.

50.5.2.5 Displaying PIM-SM Multicast Route

Run the following command to check the multicast route information learned by PIM-SM:

Command	Purpose
show ip mroute pim-sm [group-address] [source-address] [typenumber] [summary] [count] [active kbps]	Displays the PIM-SM multicast route information.

50.5.2.6 Clearing Multicast Routes Learned by PIM-SM

Run the following command to clear multicast routes learned by PIM-SM:

Command	Purpose
clear ip mroute pim-sm [* group-address] [source-address]	Clears information about the PIM-SM multicast routes.

50.5.3 Configuration Example

50.5.3.1 PIM-SM Configuration Example (The switch is configured on the VLAN port)

The following examples show how two switches learn and forward the PIM-SM multicast routes.

Device A:

```

!
ip multicast-routing
!
interface Loopback0
ip address 192.166.100.142 255.255.255.0
ip pim-sm
!
interface Ethernet1/1
ip address 192.166.1.142 255.255.255.0
ip pim-sm
    
```

```
ip pim-sm dr-priority 100
!
interface Serial2/0
ip address 192.168.21.142 255.255.255.0
physical-layer speed 128000
ip pim-sm
!
router rip
network 192.168.21.0
network 192.166.1.0
network 192.166.100.0
version 2
!
ip pim-sm bsr-candidate Loopback0 30 201
ip pim-sm rp-candidate Loopback0
!
Device B:
!
ip multicast-routing
!
interface Ethernet0/1
ip address 192.168.200.144 255.255.255.0
ip pim-sm
ip pim-sm dr-priority 200
!
interface Serial0/0
ip address 192.168.21.144 255.255.255.0
ip pim-sm
!
```

50.5.3.2 BSR Configuration Example (The switch is configured on the VLAN port)

The following example shows the BSR configuration of two switches.

Device A:

```
!
ip multicast-routing
!
interface Loopback0
ip address 192.166.100.142 255.255.255.0
ip pim-sm
```

```
!  
interface Ethernet1/1  
ip address 192.166.1.142 255.255.255.0  
ip pim-sm  
!  
interface Serial2/0  
ip address 192.168.21.142 255.255.255.0  
physical-layer speed 128000  
ip pim-sm  
!  
router rip  
network 192.168.21.0  
network 192.166.100.0  
!  
ip pim-sm bsr-candidate Loopback0 30 201  
!  
Device B:  
!  
ip multicast-routing  
!  
interface Loopback0  
ip address 192.168.100.144 255.255.255.0  
ip pim-sm  
!  
interface Ethernet0/1  
ip address 192.168.200.144 255.255.255.0  
ip pim-sm  
!  
interface Serial0/0  
ip address 192.168.21.144 255.255.255.0  
ip pim-sm  
!  
ip pim-sm bsr-candidate Loopback0 30  
!
```

Chapter 51. IPv6 Configuration

51.1 IPv6 Protocol's Configuration

The configuration of the IPv6 address of the router only takes effect on the VLAN interface, not on the physical interface.

The IPv6 protocol is disabled in default state. If the IPv6 protocol need be used on a VLAN interface, this protocol should be first enabled in VLAN interface configuration mode. To enable the IPv6 protocol, users have to set the IPv6 address. If on a VLAN interface at least one IPv6 address is set, the VLAN interface can handle the IPv6 packets and communicates with other IPv6 devices.

To enable the IPv6 protocol, users should finish the following task:

- Setting at least one IPv6 address in VLAN interface configuration mode

51.2 Enabling IPv6

51.2.1 Setting the IPv6 Address

The IPv6 address is used to determine the destination address to which the IPv6 packets can be sent. There are three kinds of IPv6 addresses.

Kind	Referred Format	Remarks
Unicast address	2001: 0: 0: 0: 0DB8: 800: 200C: 417A/64	2001: 0: 0: 0: 0DB8: 800: 200C: 417A stands for a unicast address, while 64 stands for the length of the prefix of this address.
Multicast address	FF01: 0: 0: 0: 0: 0: 0: 101	All multicast addresses begin with FF.
Any address	2002: 0: 0: 0: 0DB8: 800: 200C: 417A/64	The format of this address is the same as that of the unicast address. Different VLAN interfaces can be set to have the same address, no matter it is a unicast/broadcast/multicast address.

For the further details of the IPv6 address, see RFC 4291.

In order to enable IPv6, users must set a unicast address in VLAN interface configuration mode. The set unicast address must be one or multiple addresses of the following type:

- IPv6 link-local address
- Global IPv6 address

To set an IPv6 link-local address in VLAN interface configuration mode, run the following commands.

Command	Purpose
ipv6 enable	Sets a link-local address automatically.
ipv6 address fe80: : x link-local	Sets a link-local address manually.



The link-local address must begin with fe80. The default length of the prefix is 64 bit. At manual settings only the values at the last 64 bits can be designated.

On a VLAN interface can only one link-local address be set.

After IPv6 is enabled through the configuration of the link-local address, IPv6 only takes effect on the local link.

To set a global IPv6 address in VLAN interface configuration mode, run the following commands.

Command	Purpose
ipv6 address autoconfig	Sets a global address automatically.
ipv6 address [ipv6-address/prefix-length prefix-name sub-bits/prefix-length] [eui-64]	Sets a global address.
ipv6 address X: X: X: X: : X/<0-128> anycast	Sets an address of unicast/broadcast/multicast.



- When IPv6 is enabled through the configuration of a global address, all interconnected IPv6 device can be handled by IPv6.
- If a link-local address has not been set before the configuration of the global address, the system will set a link-local address automatically.

51.3 Setting the IPv6 Services

51.3.1 Setting the IPv6 Services

After IPv6 is enabled, all services provided by IPv6 can be set. The configurable IPv6 service is shown below:

Managing the IPv6 Link

51.3.1.1 Managing the IPv6 Link

IPv6 provides a series of services to control and manage the IPv6 link. This series of services includes:

- (1) Setting the transmission frequency of the ICMPv6 packet
- (2) Setting the source IPv6 route
- (3) Setting the MTU of IPv6

- (4) Setting IPv6 redirection
- (5) Setting IPv6 destination unreachability
- (6) Setting IPv6 ACL
- (7) Setting IPv6 Hop-Limit

1. Setting the transmission frequency of the ICMPv6 packet

If you want to limit the transmission frequency of the ICMPv6 packet, run the command in the following table. If the ICMPv6 transmission frequency is larger than the set value, the transmission frequency will be limited. The default transmission frequency is 1000us. If you want to modify the transmission frequency, run the following command in global mode:

Command	Purpose
<code>ipv6 icmp6-ratelimit <i>ratelimit</i></code>	Sets the transmission frequency of the ICMPv6 packet.

2. Setting the source IPv6 route

IPv6 allows a host to designate the route of an IPv6 network, that is, the source route. The host can realize the source route through using the routing header in the IPv6 packets. The router can forward packets according to the routing header, or desert this kind of packets considering security.

The router supports the source route by default. If the source route is closed, users can run the following command in global configuration mode to open the source route.

Command	Purpose
<code>ipv6 source-route</code>	Allows the source IPv6 route.

3. Setting the MTU of IPv6

All interfaces have a default IPv6 MTU. If the length of an IPv6 packet exceeds MTU, the router will fragment this IPv6 packet.

To set IPv6 MTU on a specific interface, run the following command in interface configuration mode:

Command	Purpose
<code>ipv6 mtu <i>bytes</i></code>	Sets IPv6 MTU on an interface.

4. Setting IPv6 redirection

Sometimes, the route selected by the host is not the best one. In this case, when a switch receives a packet from this route, the switch will transmit, according to the routing table, the packet from the interface where the packet is received, and forward it to another router which belongs to the same network segment with the host. Under this condition, the switch will notify the source host of sending the packets with the same destination address to another router directly, not by way of the switch itself. The redirection packet demands the source host to replace the original route with the more direct route contained in the redirection packet. The operating system of many hosts will add a host route to the routing table. However, the switch more trusts the information getting from the routing protocol and so the host route will not be added according to this information.

IPv6 redirection is opened by default. However, if a hot standby router protocol is configured on an interface, IPv6 redirection is automatically closed. If the hot standby router protocol is canceled, this function will not automatically opened.

To open IPv6 redirection, run the following command:

Command	Purpose
ipv6 redirects	Allows IPv6 to transmit the redirection packets.

5. Setting IPv6 destination unreachability

In many cases, the system will automatically transmit the destination-unreachable packets. Users can close this function. If this function is closed, the system will not transmit the ICMP unreachable packets.

To enable this function, run the following command:

Command	Purpose
ipv6 unreachable	Allows IPv6 to transmit the destination unreachable packets.

6. Setting IPv6 ACL

Users can use ACL to control the reception and transmission of packets on a VLAN interface. If you introduce ACL on a VLAN interface in global configuration mode and designate the filtration's direction, the IPv6 packets will be filtered on this VLAN interface.

To filter the IPv6 packets, run the following command in interface configuration mode.

Command	Purpose
ipv6 traffic-filter <i>WORD</i> { in out }	Filters the IPv6 packets in the reception or transmission direction (in: receive; out: transmit) on a VLAN interface.

7. Setting IPv6 Hop-Limit

Users can designate a router to transmit the value of the hop-limit field in the packets (except those forwarded packets). All those packets that this router transmits out, if the upper-level application does not apparently designate a hop-limit value, use the set value of hop-limit. At the same time, the value of the hop-limit field is added to the RA packets that this router transmits.

The default hop-limit value is 64. If you want to change this value, you can run the following command in interface configuration mode.

Command	Purpose
ipv6 cur-hoplimit <i>value</i>	Designates a router to transmit the hop-limit field of the packets.

Chapter 52. ND Configuration

52.1 ND Overview

A node (host and router) uses ND (Neighbor Discovery protocol) to determine the link-layer addresses of the connected neighbors and to delete invalid cache rapidly. The host also uses the neighbor to discover the packet-forwarding neighboring routers. Additionally, the node uses the ND mechanism to positively trace which neighbors are reachable or unreachable and to test the changed link-layer address. When a router or the path to a router has trouble, the host positively looks for another working router or another path.

IPv6 ND corresponds to IPv4 ARP, ICMP router discovery and ICMP redirect.

ND supports the following link types: P2P, multicast, NBMA, shared media, changeable MTU and asymmetric reachability. The ND mechanism has the following functions:

- (1) To discover routers: how the host to locate the routers on the connected links.
- (2) To discover prefixes: how the host to find a group of address prefixes, defining which destinations are on-link on the connected links.
- (3) To discover parameters: how the node to know the link-related or network-related parameters of the transmission interface.
- (4) To automatically set addresses: how the node to set the address of an interface automatically.
- (5) Address solution: When the IP of a destination is given, how a node determines the link-layer address of the on-link destination.
- (6) To determine the next hop: it is an algorithm to map the IP address of a destination to the neighboring IP. The next hop can be a router or destination.
- (7) To test unreachable neighbors: how a node to determine unreachable neighbors; if neighbor is a router, the default router can be used.
- (8) To test repeated address: how a node to determine whether a to-be-used address is not used by another node.
- (9) Redirect: how a router to notify the host of the best next hop.

52.1.1 Address Resolution

Address resolution is a procedure of resolving the link-layer address through node's IP. Packet exchange is realized through ND request and ND notification.

- Configuring a static ND cache

In most cases, dynamic address resolution is used and static ND cache configuration is not needed. If necessary, you can set static ND cache in global mode and the system will use it to translate IP into the link-layer address. The following table shows how to set a static-IP-to-link-layer-address mapping.

Run the following relative command in global mode:

Command	Purpose
ipv6 neighbor ipv6address vlan	Sets a static ND cache and translates

vlanid hardware-address	IPv6 address into a link-layer address.
-------------------------	---

52.1.2 ND Configuration

The ND protocol is used not only for address resolution but for other functions such as neighbor solicitation, neighbor advertisement, router solicitation, router advertisement and redirect.

The following commands are all run in port configuration mode:

- Setting the number of transmitted NSs when ND performs DAD on a local port

Before the IPv6 port is started, it should send the NS information to the local machine to find if there is any duplicate IPv6 address existing on links through DAD.

Command	Purpose
ipv6 nd dad attempts num	Sets the number of transmitted NSs when the local port performs DAD.

- Setting the M flag in the RA message transmitted by the local port

The M flag indicates that the RA message host should obtain addresses through on-status automatic configuration. To set the M flag in the RA message transmitted by the local port to 1, run the following command.

Command	Purpose
ipv6 nd managed-flag	Sets the M flag in the RA message transmitted by the local port.

- Setting the NS transmission interval of the local port and the retrans-timer field in the RA message

This command can be used to set the NS transmission interval of the local switch on the local port and at the same time the **retrans-timer** field in the RA message on the local port.

The host sets its **retrans-timer** variable according to the retrans-timer field in RA.

Command	Purpose
ipv6 nd ns-interval milliseconds	Means the NS retransmission interval in the local port and the retrans-timer field in the RA message. Its default value is 1000ms.

- Setting the O flag in the RA message transmitted by the local port

The O flag indicates that the RA message host should obtain other information through on-status automatic configuration. To set the O flag in the RA message transmitted by the local port to 1, run the following command:

Command	Purpose
ipv6 nd other-flag	Sets the O flag in the RA message transmitted by the local port.

- Setting the prefix of the RA message

The router releases address prefixes to the network host via RA message. The address prefix plus the host address is the entire unicast address. The prefix option is carried by the RA message, and the host obtains the IPv6 address prefix and related parameter from this option.

Command	Purpose
ipv6 nd prefix {ipv6-prefix/prefix-length default } [no-advertise [valid-lifetime preferred-lifetime [off-link no-autoconfig]]]	Means that the local port transmits the prefix option's content in the RA message.

- Setting the RA transmission interval

The following command is used to set the range of RA transmission interval. The RA transmission interval is in general an indefinite value but a random value in a fixed range, which can avoid abrupt flow surge in the network.

Command	Purpose
ipv6 nd ra-interval-range max min	Sets the range of RA transmission interval. The maximum RA transmission interval is 600s and the minimum RA transmission interval is 200s.

The interval for the local port to transmit the first three messages cannot be more than 16 seconds, while that to transmit the following messages varies between the maximum interval (600 seconds) and the minimum interval (200 seconds).

- Setting a specific RA transmission interval

RA packets are transmitted in an interval configured by **ra-interval-range**, but if users want to use a specific transmission interval, they can set this value through the following command:

Command	Purpose
ipv6 nd ra-interval interval	Sets a specific RA transmission interval, which is not set by default.

- Setting the router-lifetime field in the RA message transmitted by the local port

The **router-lifetime** field in the RA message is the triple of the maximum value of **ipv6 nd ra-interval-range**.

Command	Purpose
ipv6 nd ra-lifetime seconds	Sets the router-lifetime field in the RA message transmitted by the local port.

- Setting the reachable-time field of the RA message

reachable-time means the time to reach a neighbor, which is 0 by default.

Command	Purpose
ipv6 nd reachable-time milliseconds	Sets the reachable-time field in the RA message transmitted by the local port. Its default value is 0ms.

- Setting the value of the router preference in the RA message

router-preference means the router's priority, which accounts for two bits in the **flags** domain in the RA message. The router's priority can be high, medium and low. The medium priority is the default settings.

Command	Purpose
ipv6 nd router-preference preference	Sets the router-preference field in the RA message transmitted by the local port. It is medium by default.

- Stopping a port to be the notification port of a switch

Only the notification port can transmit RA packets. The notification port supports multicast and is set to have at least one unicast IP address. Its AdvSendAdvertisement flag is TRUE in value.

The configuration of **ipv6 nd suppress-ra** in the VLAN port means shutdown the notification port. This command is not set by default.

Command	Purpose
ipv6 nd suppress-ra	Means the value of the AdvSendAdvertisement flag on the local port. 0

Chapter 53. RIPNG Configuration

53.1 Configuring RIPNG

53.1.1 Overview

Routing Information Protocol of next generation (RIPng) is the RIP of version 6. In the equipment RIPng and RIP are two completely independent modules that are in charge of the learning and management of the routing information in version 6 and version 4 respectively.

RIPng is same to RIP in the internal working mechanism. RIPng switches the routing information through the UDP broadcast. In a router the update of the routing information is transmitted every 30 seconds. If a router has not received the routing update from its neighboring router in 180 seconds, the router will label this route unavailable in its routing table. And in the following 120 second this router will remove this route from its routing table.

RIPng can also be applied in small-scale networks. It uses the hop count to weigh the weights of different routes. This hop count means the number of routers that a packet has passed from a signal source to another signal source. The routing weight of the directly connected network is 0 and that of the unreachable network is 16. Since the route weight used by RIPng has a small range, it is unsuitable for the large-scale networks.

If a router has a default route, RIPng declares the route to the fake network 0: : 0/0. In fact, network 0: : 0/0 does not exist and it is just used to realize the default route in RIPng. If RIPng learns a default route or a router sets the default gateway and the default weight, the router will declare the default network.

RIPng sends the route update to the interface that is covered by instances. If an interface is not set to be an IPv6 interface, it will not be covered by an RIPng instance.

The RIPng protocol in our routers supports multiple instances. On an interface up to four instances can be set and one instance can cover up to 4 interfaces.

53.1.2 Setting RIPng Configuration Task List

Before setting RIPng, you have finished the following tasks. Among these tasks, you have to activate RIPng, but to other tasks, you can choose to do them according actual requirements.

- Allowing to Set the Unicast Routing Protocol
- Enabling RIPng
- Allowing the RIPng route to update the unicasting broadcast of a packet
- Applying the Offset on the Routing Weight
- Filtering the received or transmitted routes
- Setting the Management Distance
- Adjusting the Timer
- Redistributing the Routes of an Unlocal Instance
- Summarizing the Routes Manually
- Maximum Number of Routes

- Activating or Forbidding Horizontal Fragmentation
- Monitoring and Maintaining RIPng

53.1.3 RIPng Configuration Tasks

53.1.3.1 Allowing to Set the Unicast Routing Protocol

To set the RIPng, you must first run the following command to allow setting the switch of a unicast route.

Command	Purpose
ipv6 unicast-routing	Enables to set the unicast routing protocol on a device.

53.1.3.2 Enabling a RIPng Case

To enable the RIPng instance, run the following command in interface configuration mode:

Command	Purpose
ipv6 rip <i>instance-name</i> enable	Enables RIPng on an interface.

To enter the RIPng instance, run the following command in global configuration mode:

Command	Purpose
router ripng <i>instance-name</i>	Enters the RIPng instance and its configuration mode.



Users can enable a RIPng instance on an interface. If the RIPng instance does not exist, a RIPng instance will be generated. The system can directly enter the RIPng instance in global configuration mode and a RIPng instance will be generated if this RIPng instance does not exist.

Users can enable up to 4 RIPng instances on an interface and a RIPng instance can cover up to 4 interfaces.

53.1.3.3 Redistributing the Routes of an Unlocal Instance

RIPng can redistribute the routing information of an unlocal instance to the routing information database of the local instance, and then conducts route interaction with other devices through the routes in the routing database of this instance. To reach the aim above, run the following command in RIPng configuration mode:

Command	Purpose
Redistribute <i>protocol</i> [<i>instance-name</i> <i>process-id</i>]	Redistributes static routes, other ospfv6 processes, and other RIPng instances.

53.1.3.4 Allowing the RIPng Route to Update the Unicasting Broadcast of a Packet

RIPng is generally a multicast protocol. To enable RIPng routing updates to reach the non-broadcast network, users must make configuration on a router to allow the switching of routing information. To reach the aim

above, run the following command in RIPng configuration mode:

Command	Purpose
neighbor <i>ipv6-address</i>	Defines a neighboring router and switches the routing information with this neighboring router.

53.1.3.5 Applying the Offset on the Routing Weight

The offset list is used to add an offset for an incoming or outgoing route which RIPng learns. In this case, a local mechanism is provided to add the routing weight. Additionally, you can also use the access list or an interface to limit the offset list. To add the routing weight, run the following command in RIPng configuration mode:

Command	Purpose
offset { [interface-type number]* } {in out} <i>access-list-name</i> <i>offset value</i>	Adds an offset to a routing weight.

53.1.3.6 Filtering the Received or Transmitted Routes

Through settings the RIPng instance can filter the received or transmitted routes on the corresponding interface, in which flexible configuration policies can be flexibly realized. Run the following command in RIPng configuration mode:

Command	Purpose
filter <i>interface-type interface-number</i> {in out} <i>access-list</i> <i>gateway</i> <i>prefix-list</i>	Filters the received or transmitted routing information.

53.1.3.7 Setting the Management Distance

Trough setting the management distance, you can change the credibility of the route of RIPng instance. In general, the bigger the value is, the more incredible the value is. To set the management distance, run the following command in RIPng configuration mode:

Command	Purpose
distance <i>weight</i> [X: X: X: X: : X/<0-128> [<i>Acc-list_name</i>]	Sets the management distance of the RIPng instance's route.

53.1.3.8 Adjusting the Timer

The routing protocol needs several timers to judge the transmission frequency of routing updates and how long it takes for a route to become invalid. You can adjust these timers to make the performance of a routing protocol more suitable for the requirements of network interconnecting.

You can also adjust the routing protocols to speed up the convergence time of the IPv6 algorithm and make fast backup of the redundancy router, guaranteeing a maximum breakup for a terminal user when quick

recovery is needed. To adjust the timer, run the following command in RIPng configuration mode:

Command	Purpose
timers holddown <i>value</i>	Means how long it takes for a route to be removed from the routing table.
timers garbage <i>value</i>	Means how long it takes for a route to be declared invalid.
timers update <i>value</i>	Means the transmission frequency of routing updates, whose unit is second.

53.1.3.9 Summarizing the Routes Manually

RIPng must summarize the routing information manually to reduce the number of the routes that interact with neighbors. To summarize the routing information, run the following command in the RIPng configuration mode:

Command	Purpose
aggregate-address <i>ipv6-prefix/prefixlen</i>	Summarizes the routing information.

53.1.3.10 Activating or Forbidding Horizontal Fragmentation

In normal cases, a router that connects the broadcast IPv6 network and uses the distance vector routing protocol takes the horizontal fragmentation to reduce the possibility of route loopback. The horizontal fragmentation blocks the routing information from being declared to the interface that receives this routing information. In this way the communication between multiple routers can be optimized, especially when the loopback is broken. However, this solution is not so good to those un-broadcast networks. In these networks, you have to forbid horizontal fragmentation.

To activate or disable horizontal fragmentation, run the following commands in VLAN configuration mode:

Command	Purpose
ipv6 rip split-horizon	Activates horizontal fragmentation.
no ipv6 rip split-horizon	Forbids horizontal fragmentation.

By default, horizontal fragmentation is activated on those point-to-point interfaces and forbidden on those point-to-multipoint interfaces.



In normal cases, you are not recommended to change the default state unless you are sure that the routes can be correctly declared after the state of your application program is changed. If horizontal fragmentation is forbidden on a serial interface that connects a packet switching network, you have to disable horizontal fragmentation on routers of any related multicast group on a network.

53.1.3.11 Monitoring and Maintaining RIPng

Through monitoring and maintaining RIPng, you can get the statistic information of a network, including the

parameters of RIPng, the network usage information and the real communication-tracing information. This kind of information can help users to judge the usage of network resources and solve network problems. From the statistics information, you can also know the reachability of a network node.

To display all kinds of statistics information, run the following commands in EXEC mode:

Command	Purpose
show ipv6 rip <i>instance-name</i> summary	Displays the total routing information about a RIPng instance.
show ipv6 rip <i>instance-name</i> database	Displays all routes of a RIPng instance.
show ipv6 rip <i>instance-name</i> interface	Displays all interfaces that a RIPng instance covers.

To trace the information about the routing protocols, run the following commands in EXEC mode:

Command	Purpose
debug ipv6 rip <i>instance-name</i> database	Traces that a route of a RIPng instance is added to removed from or changed in a routing table.
debug ipv6 rip <i>instance-name</i> event	Traces the abnormality that occurs in the running of a RIPng instance and the whole process of redistributing a RIPng instance.
debug ipv6 rip <i>instance-name</i> send	Traces the process that a RIPng instance transmits packets.
debug ipv6 rip <i>instance-name</i> recv	Traces the process that a RIPng instance receives packets.
debug ipv6 rip <i>instance-name</i> msg	Traces the important events that lead to the termination of the startup of a RIPng instance.
debug ipv6 rip <i>instance-name</i> all	Traces all the information about a RIPng instance.

53.1.4 RIPng Configuration Example

This section shows some RIPng configuration example:

Connect device A and device B directly and make the following settings:

Device A:

```
interface VLAN2
no ip address
no ip directed-broadcast
ipv6 address 4444: : 4444/64
ipv6 enable
ipv6 rip dang2 enable
```

```
ipv6 rip dang2 split-horizon
```

```
!
```

```
router ripng dang2
```

```
redistribute static
```

```
exit
```

```
!
```

```
!
```

Device B:

```
interface Ethernet1/1
```

```
no ip address
```

```
no ip directed-broadcast
```

```
duplex half
```

```
ipv6 address 4444: : 2222/64
```

```
ipv6 enable
```

```
ipv6 rip dang enable
```

```
ipv6 rip dang split-horizon
```

```
!
```

```
router ripng dang
```

```
redistribute static
```

```
exit
```

```
!
```

In this way both device A and device B learns the static routing information from each other.

Chapter 54. OSPFv3 Configuration

54.1 Overview

OSPFv3 is an IGP routing protocol developed by the OSPF working group of IETF for the IPv6 network. OSPFv3 supports the IPv6 subnet, the mark of the external routing information and the packet's authentication.

OSPFv3 and OSPFv2 have a lot in common:

- Both router ID and area ID are 32 bit.
- The following are the same type of packets: Hello packets, DD packets, LSR packets, LSU packets and LSAck packets.
- Having the same neighbor discovery mechanism and the same neighborhood generation mechanism
- Having the same LSA expansion mechanism and the same LSA aging mechanism

The main differences of both OSPFv3 and OSPFv2 are shown below:

- OSPFv3 is running on the basis of link, while OSPFv2 is running on the basis of network segment.
- OSPFv3 can run multiple instances on the same link.
- OSPFv3 labels its neighbor through router ID, while OSPFv2 labels its neighbor through IP.
- OSPFv3 defines 7 classes of LSAs.

The following table shows some key functions in the realization of the OSPFv3 functions.

Key attributes	Description
Stub domain	Supports the stub domain.
Route forwarding	Means that routes that are learned or generated by any routing protocol can be forwarded to the domains of other routing protocols. In the autonomous domain, it means that OSPFv3 can input the RIPng learned routes. The routes learned by OSPFv3 can also be exported to RIPng. Between the autonomous domains, OSPFv3 can import the BGP-learned routes; OSPFv3 routes can also be exported to the BGPs.
Parameters of a routing interface	The following are configurable interface parameters: output cost, retransmission interval, interface's transmission delay, router's priority, interval for judging the shutdown of a router, hello interval, and authentication key.
Virtual link	Supports the virtual link.

54.2 OSPFv3 Configuration Task List

OSPFv3 demands the switchover of routing data between in-domain router, ABR and ASBR. In order to simplify the settings, you can make related configuration to enable them to work under the default parameters without any authentication; if you want to change some parameters, you must guarantee that the parameters on all routers are identical.

To set OSPFv3, you must perform the following tasks. Except that the task of activating OSPFv3 is mandatory, other settings are optional.

- Enabling OSPFv3
- Setting the parameters of the OSPFv3 interface
- Setting OSPFv3 on different physical networks
- Setting the parameters of the OSPFv3 domain
- Configuring the NSSA Domain of OSPFv3
- Setting the Route Summary in the OSPFv3 Domain
- Setting the Summary of the Forwarded Routes
- Generating a Default Route
- Choosing the route ID on the loopback interface
- Setting the management distance of OSPFv3
- Setting the Timer of Routing Algorithm
- Monitoring and Maintaining OSPFv3

54.3 OSPFv3 Configuration Tasks

54.3.1 Enabling OSPFv3

Before OSPFv3 is enabled, the function to forward the IPv6 packets must be enabled.

Run the following commands in global configuration mode:

Command	Purpose
router ospfv3 <i>process-id</i>	Activates OSPFv3 and enters the router configuration mode.
router-id <i>router-id</i>	Sets the router ID of a router on which OSPFv3 is running.

Run the following command in interface configuration mode:

Command	Purpose
ipv6 ospf <i>process-id</i> area <i>area-id</i> [instance <i>instance-id</i>]	Enables OSPFv3 on an interface.



If the OSPFv3 process is still not created before OSPFv3 is enabled on an interface, the OSPFv3 process will be automatically created.

54.3.2 Setting the Parameters of the OSPFv3 Interface

During OSPFv3 realization, related OSPFv3 parameters on an interface are allowed to be modified according to actual requirements. Of course you have no need to change every parameter, but you have to make sure that some parameters are consistent on all routers in the connected networks.

Run the following commands in interface configuration mode to do relevant configurations:

Command	Purpose
ipv6 ospf cost <i>cost</i>	Sets the cost of the packet that is transmitted from the OSPFv3 interface.
ipv6 ospf retransmit-interval <i>seconds</i>	Sets the LSA retransmission interval between neighbors.
ipv6 ospf transmit-delay <i>seconds</i>	Sets the delay time for transmitting LSA on an OSPFv3 interface.
ipv6 ospf priority <i>number</i>	Sets a router to be the priority of the OSPFv3 DR router.
ipv6 ospf hello-interval <i>seconds</i>	Sets the interval for the OSPFv3 interface to transmit the Hello packets.
ipv6 ospf dead-interval <i>seconds</i>	Means that in a regulated interval if the OSPFv3 packets are not received from a neighboring router, this neighboring router is viewed to be shut down.

54.3.3 Setting OSPFv3 on Different Physical Networks

OSPFv3 divides physical network media into the following three kinds:

- Broadcast networks (Ethernet, Token Ring, FDDI)
- Non-broadcast and multi-access networks (SMDS, Frame Relay, X.25)
- Point-to-point networks (HDLC, PPP)

54.3.4 Setting the OSPF Network Type

No matter what physical media type the network is, you can configure your network to be a broadcast network, a non-broadcast network or a multi-access network. So you can set your network flexibly and your network can be set to be a non-broadcast and multi-access one, or a broadcast network such as the X.25, Frame Relay or SMDS network. Also the neighbor's settings will be simplified.

To set an un-broadcast and multi-access network is to suppose that every two routers have a virtual link or suppose a full-mesh network. It is unrealistic due to unbearable cost. But you set this network to be a

point-to-multipoint one. Between those routers which are not adjacent the routing information can be switched through the virtual link.

The OSPFv3 point-to-multipoint interface can be set to be multipoint-to-point interface, through which multiple routes of a host can be established. The OSPFv3 point-to-multipoint network, comparing with the non-broadcast and multi-access network or the point-to-point network, has the following advantages:

- The point-to-multipoint network is easy to be set without generating DR.
- This kind of network do not require the full-mesh topology, so the construction cost is relatively low.
- This kind of networks are more reliable. Even if its virtual link fails, the connection can be maintained.

The network type of the routers is the broadcast type.

54.3.5 Setting the Parameters of the OSPFv3 Domain

The configurable domain parameters include: authentication, designating a stub area and specifying a weight for a default summary route. Its authentication is based on password protection.

The stub area means that external routes cannot be distributed to this area. Instead, ABR generates a default external route that enters the stub area, enabling the stub area to communicate with external networks of an autonomous area. In order to make use of the attributes supported by the OSPF stub, the default route must be used in the stub area. To further reduce LSAs that are forwarded to the stub area, you can forbid the summary function on ABR.

Run the following command in router configuration mode to set the domain's parameters:

Command	Purpose
area <i>area-id</i> stub [<i>no-summary</i>]	Defines a stub area.
area <i>area-id</i> default-cost <i>cost</i>	Sets the weight of the default route of the stub area.

As to those areas that are not backbone areas and do not connect the backbone areas directly or as to those discontinuous areas, the OSPFv3 virtual link can be used to establish a logic connectivity. In order to create a virtual link, you have to perform configuration at the two terminals of the virtual link. If only one terminal is configured, the virtual link cannot work.

Run the following command in router configuration mode to set the domain's parameters:

Command	Purpose
area <i>area-id</i> virtual-link <i>neighbor-ID</i> [<i>dead-interval</i> <i>dead-value</i>][hello-inter val <i>hello-value</i>][retransmit-interval <i>retr</i> <i>ans-value</i>][transmit-delay <i>dly-value</i>]	Establishes the virtual link.

54.3.6 Setting the Route Summary in the OSPFv3 Domain

With this function ABR can broadcast a summary route to other areas. In OSPFv3 ABR will broadcast each network to other areas. If network IDs are distributed to be continuous, you can set ABR to broadcast a summary route to other areas. The summary route can cover all networks in a certain range.

Run the following command in router configuration mode to set the address' range:

Command	Purpose
area <i>area-id</i> range <i>ipv6-prefix</i> <i>/prefix-length</i>	Sets the address' range of the summary route.

54.3.7 Setting the Summary of the Forwarded Routes

When routes are distributed from other routing areas to the OSPFv3 routing area, each route is singularly broadcasted as an external LSA. However, you can set a route on a router to make this route cover an address range. In this way, the size of the OSPFv3 link-state database can be reduced.

Run the following command in router configuration mode to set a summary route:

Command	Purpose
summary-prefix <i>ipv6-prefix</i> <i>/prefix-length</i>	Broadcasts only one summary route.

54.3.8 Generating a Default Route

ASBR should generate a default route to enter the OSPFv3 routing area. Whenever it is, you make configuration to enable a router to distribute a route to the OSPFv3 routing area and this route becomes ASBR automatically. However, ASBR does not generate a default route by default to enter the OSPFv3 routing area.

54.3.9 Choosing the Route ID on the Loopback Interface

OSPFv3 uses the maximum IPv4 address as its router ID. If the interface that connects the IPv4 address is down or the IPv4 address is deleted, the OSPF process will recalculate the ID of this new router and retransmit the routing information from all interfaces.

If an IPv4 address is configured on a loopback interface, the router will first use the IPv4 address of loopback as its ID. Because the loopback interface will never be down, the routing table is greatly stable.

The router can first select the loopback interface as its ID or select the maximum IPv4 address in all loopback interfaces as its ID. If there is no loopback interface, the IPv4 address of a router will be used as the router ID.

You cannot specify OSPFv3 to use any specific interface.

Run the following commands in global configuration mode to set the IP loopback interface:

Command	Purpose
interface loopback <i>num</i>	Creates a loopback interface and enters the interface configuration mode.
ip address <i>ip-address mask</i>	Distributes an IPv4 address for an interface.

54.3.10 Setting the Management Distance of OSPFv3

The management distance means the trust level of the routing information source. Generally speaking, the management distance is an integer between 0 and 255. The bigger its value is, the lower the trust level is. If the management distance is 255, the routing information source will be distrusted and omitted.

OSPFv3 uses three different kinds of management distances: inter-domain, inner-domain and exterior. The routes in a domain are called inner-domain routes; the routes to other domains are called inter-domain routes; the routes transmitted from other routing protocols are called the exterior routes. The default value of each kind of routes is 110.

54.3.11 Setting the Timer of Routing Algorithm

You can set the delay between receiving the topology change information and calculating SPF. You can also set the interval between two continuous SFP algorithm.

Run the following command in router configuration mode:

Command	Purpose
timersdelay <i>delaytime</i>	Set a delay for routing algorithm in an area.
timershold <i>holdtime</i>	Sets a minimum interval for routing algorithm in an area.

54.3.12 Monitoring and Maintaining OSPFv3

The network statistics information which can be displayed includes the content of the IP routing table, caching and database. This kind of information can help users to judge the usage of network resources and solve network problems.

You can run the following commands to display all kinds of routing statistics information:

Command	Purpose
show ipv6ospf [<i>process-id</i>]	Displays the general information about the OSPFv3 routing process.
show ipv6 ospf [<i>process-id</i>] database show ipv6 ospf [<i>process-id</i>] database [<i>router</i>] [<i>adv-router router-id</i>] show ipv6 ospf [<i>process-id</i>] database [<i>network</i>] [<i>adv-router router-id</i>] show ipv6 ospf [<i>process-id</i>] database [<i>inter-prefix</i>][<i>adv-router router-id</i>] show ipv6 ospf [<i>process-id</i>] database [<i>inter-router</i>][<i>adv-router router-id</i>] show ipv6 ospf [<i>process-id</i>] database [<i>external</i>][<i>adv-router router-id</i>] show ipv6 ospf [<i>process-id</i>] database [<i>link</i>][<i>adv-router router-id</i>] show ipv6 ospf [<i>process-id</i>] database [<i>intra-prefix</i>][<i>adv-router router-id</i>]	Displays the information about the OSPFv3 database.
show ipv6 ospf interface	Displays the information about the OSPFv3 interface.

show ipv6 ospf neighbor	Displays the information about OSPFv3 neighbors.
show ipv6 ospf route	Displays the routing information about OSPFv3.
show ipv6 ospf topology	Displays the OSPFv3 topology.
show ipv6 ospf virtual-links	Displays the virtual links of OSPFv3.
debug ipv6 ospf	Monitors all OSPFv3 behaviors.
debug ipv6 ospf events	Monitors the OSPFv3 events.
debug ipv6 ospf ifsm	Monitors the state machine of the OSPFv3 interface.
debug ipv6 ospf lsa	Monitors related behaviors about OSPFv3 LSA.
debug ipv6 ospf n fsm	Monitors the state machine of the OSPFv3 neighbors.
debug ipv6 ospf nsm	Monitors the information of which the management module notifies OSPFv3.
debug ipv6 ospf packet	Monitors the OSPFv3 packets.
debug ipv6 ospf route	Monitors the routing information about OSPFv3.

54.4 OSPFv3 Configuration Example

54.4.1 Example for OSPFv3 Route Learning Settings

OSPFv3 requires switching information among many internal routers, ABR and ASBR. In the minimum settings, the OSPFv3-based router works under the case that all its parameters take their default values and there is no authentication.

The following are three configuration examples:

The first example shows the commands for basic OSPFv3 settings.

The second example shows multiple OSPFv3 processes can be set on a router.

The third example shows how to use OSPFv3 to learn routes.

The fourth example shows how to set the OSPFv3 virtual link.

1. Basic OSPFv3 Configuration Example

The following example shows a simple OSPFv3 settings. In this example, you have to activate process 90, connect Ethernet interface 0 to area 0.0.0.0, distribute RIPng to OSPFv3 and OSPFv3 to RIPng.

```
ipv6 unicast-routing
```

```
!
```

```
interface vlan 10
ipv6 address 2001: : 1/64
ipv6 enable
ipv6 rip aaa enable
ipv6 rip aaa split-horizon
```

```
ipv6 ospf 90 area 0
ipv6 ospf cost 1
!
router ospfv3 90
router-id 1.1.1.1
redistribute rip
!
router ripng aaa
redistribute ospf 90
```

2. Configuring multiple OSPFv3 processes

The following example shows that two OSPFv3 processes are created.

```
ipv6 unicast-routing
!
!
interface vlan 10
ipv6 address 2001: : 1/64
ipv6 enable

ipv6 ospf 109 area 0 instance 1
ipv6 ospf 110 area 0 instance 2
!
!
interface vlan 11
ip address 2002: : 1/64
ipv6 enable

ipv6 ospf 109 area 1 instance 1
ipv6 ospf 110 area 1 instance 2
!
!
router ospfv3 109
router-id 1.1.1.1
redistribute static
```

```
!
router ospfv3 110
router-id 2.2.2.2
!
```

Each interface can belong to many OSPFv3 processes, but if an interface belongs to multiple OSPFv3 processes each OSPFv3 process must correspond to different instances.

3. Complicated configuration example

The following example shows how to configure multiple routers in a single OSPFv3 autonomous system. The following figure shows the network topology of the configuration example:

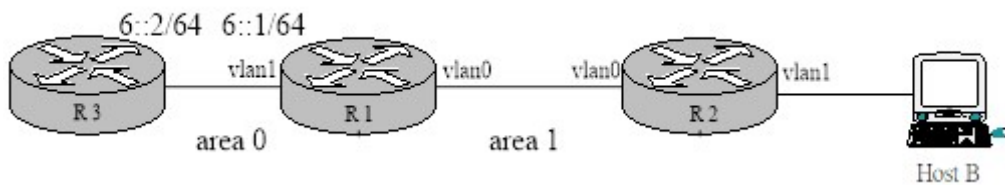

Configure the router according to the above-mentioned figure:

R1:

```
interface vlan 0
ipv6 enable

ipv6 ospf 1 area 1
!
interface vlan 1
ipv6 enable

ipv6 ospf 1 area 0
!
ipv6 route 2001: : /64 6: : 2
!
router ospfv3 1
router-id 1.1.1.1
redistribute static
!
```

R2:

```
interface vlan 0
ipv6 enable

ipv6 ospf 1 area 1
```

```
!  
!  
router ospfv3 1  
router-id 2.2.2.2  
!
```

Browsing the routing table of R2:

```
R2#show ipv6 route  
O 6: : /64[1]  
[110,20] via fe80: 4: : 2e0: fff: fe26: 2d98(on VLAN0)  
O 2001: : /64[1] (forwarding route)  
[110,150] via fe80: 4: : 2e0: fff: fe26: 2d98(on VLAN0)  
C fe80: : /10[1]  
is directly connected, L,Null0  
C fe80: : /64[1]  
is directly connected, C, VLAN0  
C fe80: : 2e0: fff: fe26: a8/128[1]  
is directly connected, L, VLAN0  
C ff00: : /8[1]  
is directly connected, L,Null0
```

From the command sentences above, we can see that R2 has learned route forwarding.

Setting area 1 to be the stub area:

```
R1:  
interface vlan 0  
ipv6 enable  
  
ipv6 ospf 1 area 1  
!  
interface vlan 1  
ipv6 enable  
  
ipv6 ospf 1 area 0  
!  
ipv6 route 2001: : /64 6: : 2  
!  
router ospfv3 1  
router-id 1.1.1.1  
area 1 stub  
redistribute static
```

!

R2:

```
interface vlan 0
ipv6 enable

ipv6 ospf 1 area 1
!
!
router ospfv3 1
router-id 2.2.2.2
area 1 stub
!
```

Browsing the routing table of R2:

```
R2#show ipv6 route
O :: : /0[1]
[110,11] via fe80: 4: : 2e0: fff: fe26: 2d98(on VLAN0)
O 6: : /64[1]
[110,20] via fe80: 4: : 2e0: fff: fe26: 2d98(on VLAN0)
C fe80: : /10[1]
is directly connected, L,Null0
C fe80: : /64[1]
is directly connected, C, VLAN0
C fe80: : 2e0: fff: fe26: a8/128[1]
is directly connected, L, VLAN0
C ff00: : /8[1]
is directly connected, L,Null0
```

It can be judged that ABR in the stub area can generate a default route normally and notify other routers in this area without importing ASE LSA into the stub area.

4. Configuring the virtual link

The following example shows how to configure a virtual link in a single autonomous OSPFv3 system. The following figure shows the network topology of the configuration example:

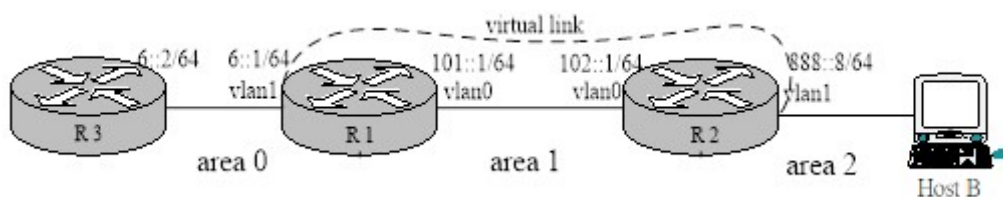

Configure the router according to the above-mentioned figure:

R1:

```
interface vlan 0
```

```
ipv6 address 101: : 1/64
```

```
ipv6 enable
```

```
ipv6 ospf 1 area 1
```

```
!
```

```
interface vlan 1
```

```
ipv6 address 6: : 1/64
```

```
ipv6 enable
```

```
ipv6 ospf 1 area 0
```

```
!
```

```
ipv6 route 2001: : /64 6: : 2
```

```
!
```

```
router ospfv3 1
```

```
router-id 200.200.200.1
```

```
area 1 virtual-link 200.200.200.2
```

```
redistribute static
```

```
!
```

R2:

```
interface vlan 0
```

```
ipv6 address 101: : 2/64
```

```
ipv6 enable
```

```
ipv6 ospf 1 area 1
```

```
!
```

```
interface vlan 1
```

```
ipv6 address 888: : 8/64
```

```
ipv6 enable
```

```
ipv6 ospf 1 area 2
```

```
!
```

```
!
```

```
router ospfv3 1
```

```
router-id 200.200.200.2
```

```
area 1 virtual-link 200.200.200.1
```

```
!
```

Browsing the state of the OSPFv3 neighbor:

R1#show ipv6 ospf neighbor

OSPFv3 Process (1)

Neighbor ID	Pri	State	Dead Time	Interface	Instance ID
200.200.200.2	1	Full/DR	00: 00: 35	VLAN0	0
200.200.200.2	1	Full/-	00: 00: 36	VLINK1	0

R2#show ipv6 ospf neighbor

OSPFv3 Process (1)

OSPFv3 Process (1)

Neighbor ID	Pri	State	Dead Time	Interface	Instance ID
200.200.200.1	1	Full/Backup	00: 00: 36	VLAN0	0
200.200.200.1	1	Full/-	00: 00: 37	VLINK1	0

Browsing the information in the routing table:

R1#show ipv6 route

C 6: : /64[1]

is directly connected, C,VLAN1

C 6: : 1/128[1]

is directly connected, L, VLAN1

C 101: : /64[2]

is directly connected, C, VLAN0

C 101: : 1/128[2]

is directly connected, L, VLAN0

O 101: : 2/128[2]

[110,10] via fe80: 4: : 2e0: fff: fe26: a8(on VLAN0)

O 888: : /64[2]

[110,20] via fe80: 4: : 2e0: fff: fe26: a8(on VLAN0)

S 2001: : /64[1]

[1,0] via 6: : 2(on VLAN1)

C fe80: : /10[2]

is directly connected, L,Null0

C fe80: : /64[2]

is directly connected, C, VLAN0

C fe80: : 2e0: fff: fe26: 2d98/128[2]

is directly connected, L, VLAN0

C fe80: : /64[1]

is directly connected, C, VLAN1

C fe80: : 2e0: fff: fe26: 2d99/128[1]

is directly connected, L, VLAN1

C ff00: : /8[2]

is directly connected, L, Null0

R2#show ipv6 route

O 6: : /64[1]

[110,20] via fe80: 4: : 2e0: fff: fe26: 2d98(on VLAN0)

C 101: : /64[1]

is directly connected, C, VLAN0

O 101: : 1/128[1]

[110,10] via fe80: 4: : 2e0: fff: fe26: 2d98(on VLAN0)

C 101: : 2/128[1]

is directly connected, L, VLAN0

C 888: : /64[1]

is directly connected, C, VLAN1

C 888: : 8/128[1]

is directly connected, L, VLAN1

O 2001: : /64[1]

[110,150] via fe80: 4: : 2e0: fff: fe26: 2d98(on VLAN0)

C fe80: : /10[1]

is directly connected, L, Null0

C fe80: : /64[1]

is directly connected, C, VLAN0

C fe80: : 2e0: fff: fe26: a8/128[1]

is directly connected, L, VLAN0

C fe80: : /64[1]

is directly connected, C, VLAN1

C fe80: : 2e0: fff: fe26: a9/128[1]

is directly connected, L, VLAN1

C ff00: : /8[1]

is directly connected, L, Null0

Chapter 55. BFD Configuration

55.1 Overview

BFD (Bidirectional Forwarding Detection) is a set of all-net uniform detection mechanism used for rapid detection and monitoring of link or IP routing forwarding connectivity. To improve the performance of existing networks, communication troubles can be detected rapidly between neighboring protocols so that a standby communication channel can be quickly established.

BFD can establish sessions between two machines to monitor bidirectional forwarding paths between the two machines and serve upper-level protocols. The served upper-level protocol notifies BFD of the one with which the session is established. After the session is established through the three-handshake mechanism, no reception of BFD control packets from the peer within the detection time or the number of dropped echo packets outnumbering the allowed threshold causes trouble. This case is then reported to the upper-level protocol for corresponding processing.

55.2 BFD Configuration Tasks

55.2.1 Activating Port BFD

Port BFD is not activated by default.

After port BFD is enabled, BFD configured through dynamic protocols takes effect.

Run the following command to achieve the previous purpose:

Command	Purpose
bfd enable <cr> [min_tx_interval <tx_value> min_rx_interval <rx_value> multiplier <m_value>]	Activates port BFD.

Before the BFD session is established, the BFD control packets are transmitted in an interval of no less than 1 second so as to narrow down traffic. After the session is established, the BFD control packets are transmitted in a negotiated interval so as to realize rapid detection. During the establishment of BFD session, the transmission interval and detection time of BFD control packets are also determined via packet exchange. In an effective BFD session, these timers can be modified through negotiation at any time without affecting the session status. The timer negotiations at different BFD session directions are conducted independently and the bidirectional timers can be different. The transmission interval for BFD control packets is the maximum value between local **min_tx_interval** and peer **min_rx_interval**, that is to say, the comparatively slow part decides the transmission frequency.

The detection time is **Detect Mult** in peer BFD control packets multiplied the negotiated transmission interval of peer BFD control packets. If you increase **min_tx_interval** of the local end, the actual transmission interval

of BFD control packets on the local end cannot be modified until the packets reset by the peer's F field are received, which ensures that the detection time is lengthened on the peer before the increase of the transmission interval of BFD control packets on the local end. Otherwise, the detection timer on the peer may time out.

If **min_rx_interval** on the local end is decreased, the local detection time cannot be modified until the packets reset by the peer's F field are received, which ensures that the transmission interval of BFD control packets on the peer has been decreased before the decrease of local detection time. However, if **min_tx_interval** is decreased, the local transmission interval of BFD control packets may decrease immediately; if **min_rx_interval** is increased, the local detection time will increase immediately.

55.2.2 Activating the Port BFD Query Mode

The port BFD query mode is not activated by default.

In query mode, we suppose that each system has an independent method to confirm its connection with other systems. Once a BFD session is established, the system stops transmitting BFD control packets unless a certain system requires explicit connectivity checkup. In a system where explicit connectivity checkup is required, the system transmits short-sequence BFD control packets and claims the session is down if it doesn't receive the response packets in the checkup period. If the response packets are received from the peer in the checkup period, it means the forwarding path is normal and the BFD control packets then stop being transmitted.

Run the following command to achieve the previous purpose:

Command	Purpose
<code>bfd demand enable</code>	Activates the BFD query mode.

The system supports to activate or deactivate the BFD query mode.

55.2.3 Activating Port BFD Echo

Port BFD echo is not activated by default.

After the BFD echo is activated, if the neighbor supporting BFD echo is up, the control packets are transmitted according to the interval configured by slow-timers. The connectivity detection is finished by the echo packets and the transmission interval of echo packets is the time configured by **min_echo_rx_interval**.

Run the following command to achieve the previous purpose:

Command	Purpose
<code>bfd echo enable<cr> <number></code>	Activates BFD echo.

The activation and shutdown of echo functionality on an already "up" neighbor has no impact on this neighbor's status, but the transmission interval of control packets is affected.

55.2.4 Enabling Port BFD Authentication

Port BFD authentication is not activated by default.

Authentication configuration takes immediate effect before BFD neighbor is up, and the two terminals of a link on which BFD detection is conducted can be up only when their BFD authentication configurations are same. But if authentication configuration is modified after BFD neighbor is up, the same configurations or different configurations on the two terminals have no any impact on the BFD neighbor's status.

Run the following command to achieve the previous purpose:

Command	Purpose
bfd authentication-mode [md5 meticulous md5 simple] <key id><key>	Enables the BFD authentication function.

Displaying the BFD Statistics Information

You can run the following commands to display all kinds of BFD statistics information:

Command	Purpose
show bfd interfaces <i>[details]</i>	Displays the ports in the system on which BFD is activated.
show bfd neighbors <i>[details]</i>	Displays BFD neighbors in the system.

55.3 BFD Configuration Example

You need to set related protocols for BFD detection and activate the BFD function on the corresponding port before configuring BFD.

The following example shows how BFD provides BGP with bidirectional detection:

Establish the EBGP relationship between A and B, and check the link through BFD.

A:

```
interface vlan1
ip address 1.1.1.1 255.255.255.0
bfd enable
no ip directed-broadcast
!
router bgp 100
no synchronization
bgp log-neighbor-changes
neighbor 1.1.1.2 remote-as 200
neighbor 1.1.1.2 fall-over bfd
```

!

B:

```
interface vlan1
ip address 1.1.1.2 255.255.255.0
bfd enable
no ip directed-broadcast
!
router bgp 200
no synchronization
bgp log-neighbor-changes
neighbor 1.1.1.1 remote-as 100
neighbor 1.1.1.1 fall-over bfd
!
```

Chapter 56. SNTP Configuration

56.1 Overview

56.1.1 Stipulations

56.1.1.1 Format Stipulation in the Command Line

Syntax	Definition
Bold	Stands for the keyword in the command line, which stays unchanged and must be entered without any modification. It is presented as a bold in the command line.
<i>{italic}</i>	Stands for the parameter in the command line, which must be replaced by the actual value. It must be presented by the italic in the brace.
< <i>italic</i> >	Stands for the parameter in the command line, which must be replaced by the actual value. It must be presented by the italic in the point bracket.
[]	Stands for the optional parameter, which is in the square bracket.
{ x y ... }	Means that you can choose one option from two or more options.
[x y ...]	Means that you can choose one option or none from two or more options.
{ x y ... } *	Means that you has to choose at least one option from two or more options, or even choose all options.
[x y ...] *	Means that you can choose multiple options or none from two or more options.
&<1-n>	Means that the parameter before the “&” symbol can be entered <i>n</i> times.
#	Means that the line starting with the “#” symbol is an explanation line.

56.2 SNTP Configuration

56.2.1 Overview

Simple Network Time Protocol (SNTP) is currently an important method to realize time synchronization on the Internet.

SNTP adopts the client-server mode. The server obtains its own time by receiving the GPS signals or takes its own atomic clock as its time standard, while the client, by regularly accessing the time service provided by the server, gets the correct time information and regulates its own clock to synchronize with the time on the Internet. The UDP protocol and port 123 are used for the communication between the client and the server.

56.2.2 SNTP Configuration Task List

SNTP settings can be divided into two parts: one part is for the local switch to take as the SNTP server, and the other is for the local switch to take as the SNTP client.

The local switch takes as the SNTP server:

- Setting the Grade of the SNTP Server
- Enabling the SNTP Server

The local switch takes as the SNTP client:

- Setting the IP Address of the SNTP Server
- Setting the Interval of Browsing the SNTP Server
- Disabling the SNTP Server

56.2.3 SNTP Configuration

56.2.3.1 Setting the Grade of the SNTP Server

Configuration mode: Global

Command	Purpose
sntp master [Stratum]	Sets the grade of the SNTP server.

56.2.3.2 Enabling the SNTP Server

Configuration mode: Global

Command	Purpose
sntp master	The SNTP server is enabled by default.

56.2.3.3 Setting the IP Address of the SNTP Server

Configuration mode: Global

Command	Purpose
sntp server <A.B.C.D> [sntp-version]	Sets the IP address and version of the SNTP server.

56.2.3.4 Setting the Interval of Browsing the SNTP Server

Configuration mode: Global

Command	Purpose
sntp query-interval < minutes>	Sets the interval for the SNTP client to browse the SNTP server.

56.2.3.5 Disabling the SNTP Server

Configuration mode: Global

Command	Purpose
no sntp master	Closes the SNTP server.

Chapter 57. Cluster Management Configuration

57.1 Overview

The switch cluster is a group of switches which can be managed as a single entity. In the cluster, there must be a switch worked as the command switch, which allows up to 255 switches simultaneously to join the cluster as member switches. As the single access node in the cluster, the command switch is used to configure, manage and monitor member switches. One switch belongs to only one cluster at a certain moment.

57.2 Cluster Management Configuration Task List

- Planning cluster
- Creating cluster
- Configuring cluster
- Monitoring the state of standby group
- Using SNMP to manage cluster
- Using Web to manage cluster

57.3 Cluster Management Configuration Task

57.3.1 Planning Cluster

A. VLAN

To manage the switch through the cluster, the command switch, the member switch and candidate switch of a cluster must have the default VLAN. The interface of the default VLAN of these switches has already existed.

B. Automatically discovering member switches and candidate switches

The command switch uses the BDP protocol to find the member switch, candidate switch and other clusters. The command switch also uses the BDP protocol to find the network topology. Therefore, you need to run the BDP protocol on the member switch, candidate switch and other clusters and activate BDP on the interconnected interfaces.

C. IP address

If the management station accesses the cluster through the TCP/IP management mode, such as telnet, http and snmp, you need configure the IP address of the command switch that the management station can access. You need not configure the IP address for the member switch of the cluster.

After the member switch joins in the cluster, the command switch distributes an IP address to each member switch. These IP addresses are selected from the IP pool of the cluster configured on the command switch.

When planning the address pool, pay attention that the service addresses cannot be the same as those in the address pool; note that the address number in the address pool cannot be smaller than the maximum number of member switches in the cluster (including the command switch).

57.3.2 Creating Cluster

A. Activating command switch

Run the following command in global configuration mode to set the current switch to the command switch:

Command	Description
cluster mode commander <i>cluster-name</i>	Sets the current switch to the command switch.

B. Activating standby switch

Run the following command in global configuration mode to set the current switch to the standby switch:

Command	Description
cluster mode commander <i>member</i>	Sets the current switch to the standby switch.

C. Adding member switch

Run the following command in global configuration mode to add the standby switch with the designated MAC address to the cluster:

Command	Description
cluster member [<i>idmember-id</i>] mac-address <i>H.H.H</i> [password <i>enable-password</i>]	Adds member switch.

57.3.3 Configuring Cluster

A. Configuring IP pool

Run the following command in global configuration mode to configure the IP address pool for cluster management:

Command	Description
cluster address-pool <i>A.B.C.D</i> <i>A.B.C.D</i>	Configures the IP address pool.

B. Configuring hellotime

You can modify the interval to send the handshake message between the command switch and the member switch by configuring hellotime (unit: second).

Run the following command in global configuration mode to configure the cluster's hellotime:

Command	Description
---------	-------------

cluster hellotime <1-300>	Configures the interval of sending hello message between the command switch and the member switch.
----------------------------------	--

C. Configuring holdtime

If the member switch and the command switch do not receive the handshake message from the peer in an interval, they think the peer is in **down** state. You can configure **holdtime** to change the interval value

Run the following command in global configuration mode to configure the cluster's hellotime:

Command	Description
cluster holdtime <1-300>	Configures the interval of sending handshake message between the command switch and the member switch.

D. Configuring hop number of the discovery protocol

The cluster uses the hop number to measure the distance of switches in the cluster. The hop number of the discovery protocol configured on the command switch equals the distance between the cluster verge and the candidate switch which is farthest to the cluster verge.

Run the following command in global configuration mode to configure the hop number of the discovery protocol for the cluster:

Command	Description
cluster discovery hop-count	Configures the PDP hop number of the discovery protocol.

57.3.4 Monitoring the State of Standby Group

Run the following command in privileged mode to monitor the configuration and state of cluster:

Command	Description
show cluster	Monitors the state of the standby group.
show cluster member	Checks the cluster member.
show cluster candidate	Checks the cluster candidate.
show cluster topo	Checks the cluster topology.
show address-pool	Checks the address pool the cluster.

57.3.5 Using SNMP to Manage Cluster

After the cluster is created, the snmp message can be transmitted between the member switch and the snmp application through the command switch. The detailed process is shown as follows:

To access No. N member switch in snmp mode, specify the destination IP address as the address of the switch in an snmp application.

Set **community string** to **community string + @esN**, which belongs to the corresponding right of the command switch. If **community string** on the command switch is **public**, **community string** of No.6

member switch is **public@es6**.

57.3.6 Using Web to Manage Cluster

After the cluster is created, the http message can be transmitted between the member switch and the browser through the command switch. The detailed operation is to add prefix like “esN/” before the url.

Suppose the IP of the command switch is 192.168.20.1, the url of the No.6 member switch is http://192.168.20.1/es6/.